

DeLonghi

**CERAMIC FAN HEATER
INSTRUCTION MANUAL
SAVE THESE INSTRUCTIONS**

**RADIATEUR CÉRAMIQUE
MODE D'EMPLOI
CONSERVEZ CE MODE D'EMPLOI**

**TERMOVENTILADOR CERÁMICO
INSTRUCCIONES DE USO
CONSERVE ESTAS INSTRUCCIONES
LEA CUIDADOSAMENTE ESTE INSTRUCTIVO
ANTES DE USAR SU APARATO**

**TERMOVENTILATORE CERAMICO
ISTRUZIONI PER L'USO
CONSERVARE LE PRESENTI ISTRUZIONI**

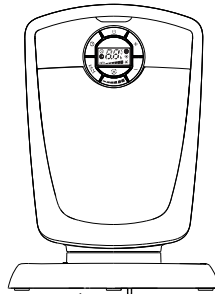

**MODEL/MODÈLE/MODELO/MODELLO
DCH4590ER**

Register this product on-line and receive a free trial issue of Cook's Illustrated.
Visit www.delonghiregistration.com.
Visit www.delonghi.com for a list of service centers near you. (U.S. Only)

Enregistrez ce produit en ligne et recevez un numéro gratuit de Cook's Illustrated.
Visitez www.delonghiregistration.com.
Visitez www.delonghi.com pour y voir une liste des centres de réparation proches de chez vous. (E.-U. uniquement)

Registre este producto en línea y reciba un ejemplar gratis de Cook's Illustrated.
Visite www.delonghiregistration.com.
Visite www.delonghi.com para ver la lista de centros de servicios cercanos a usted. (Solamente en los Estados Unidos)

Registra questo prodotto "on-line" per ricevere una copia omaggio della rivista Cook's Illustrated. Visita www.delonghiregistration.com.
Visita www.delonghi.com per una lista dei centri di servizio a te più vicini. (Solo negli Stati Uniti).

ELECTRONIC CHARACTERISTICS/CARACTÉRISTIQUES ÉLECTRONIQUES
CARACTERÍSTICAS ELÉCTRICAS/CARATTERISTICHE ELETTICHE
120V~60Hz 1500W

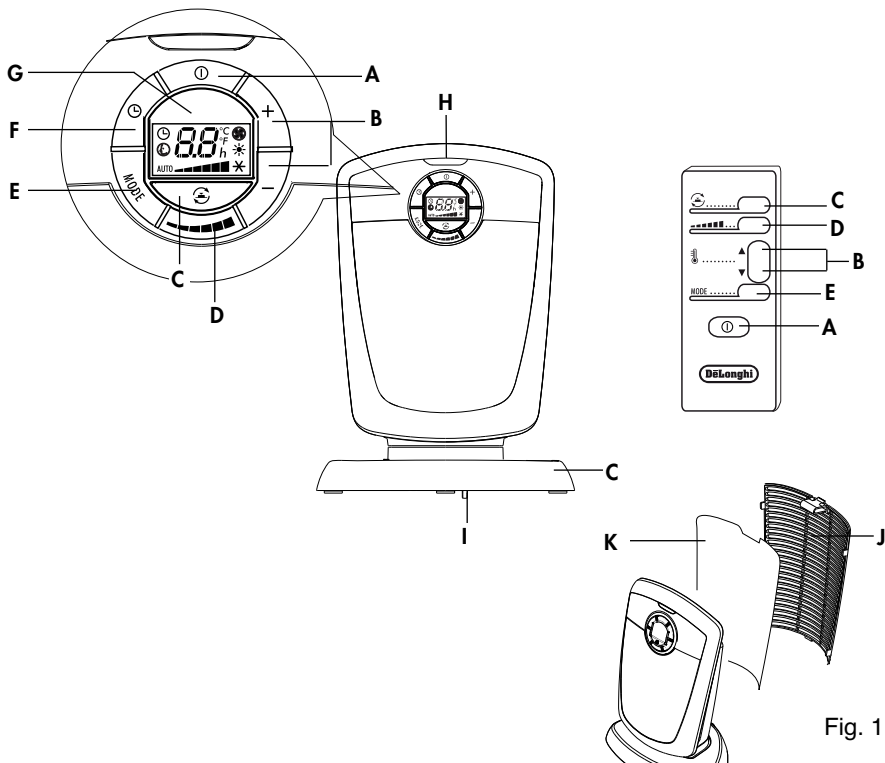

Fig. 1



DESCRIPTION

- A ON/STAND-BY button
- B +/- Adjustment buttons
- C Oscillation button
- D Power selector
- E MODE button (for selecting the operating mode)
- F Timer button
- G Receiver for remote control
- H Power indicator light
- I Safety tip-over switch
- J Back Cover
- K Filter



DESCRIPTION DE L'APPAREIL

- A Touche ON/STAND-BY
- B Touches de réglage +/-
- C Touche d'oscillation
- D Touche de sélection de la puissance
- E Touche MODE (sélection du mode de fonctionnement)
- F Touche minuterie
- G Récepteur de la télécommande
- H Lampe témoin
- I Dispositif d'anti-renversement
- J Grille
- K Filtre



DESCRIPCIÓN DEL APARATO

- A Botón de ON/STAND-BY (ENCENDIDO/EN ESPERA)
- B Botón de ajuste +/-
- C Botón de oscilación
- D Botón de selección de potencia
- E Botón MODE (selecciona la modalidad de funcionamiento)
- F Botón temporizador
- G Receptor del control remoto
- H Lámpara piloto
- I Dispositivo antivuelco
- J Rejilla
- K Filtro



DESCRIZIONE DELL'APPARECCHIO

- A Pulsante ON/STAND-BY
- B Pulsanti regolazione +/-
- C Pulsante oscillazione
- D Pulsante selezione della potenza
- E Pulsante MODE (selezione della modalità di funzionamento)
- F Pulsante timer
- G Ricevitore del telecomando
- H Lampada spia
- I Dispositivo antiribaltamento
- J Griglia
- K Filtro



SAFETY PRECAUTIONS

When using any electrical appliance, some basic safety precautions should be observed to reduce the risk of fire, electric shock, and/or injury to persons. Specifically:

1. Read all instructions carefully before using the appliance.
2. If the appliance comes with a polyethylene strap to use as a carrying handle, remove it before connecting the appliance to an electrical outlet.
3. This appliance gets very hot when in use. To prevent burns, do not touch hot surfaces with bare skin. Use the handle when moving the heater. Keep all flammable materials, such as furniture, pillows, bedding, paper, clothing, and curtains at least 3 feet (90 cm) from the front and top of the heater, also avoid contact with the sides and back.
4. The appliance is not intended for use by persons (including children) with reduced physical, sensory or mental capabilities, or lack of experience and knowledge, unless they have been given supervision or instruction concerning use of the appliance by a person responsible for their safety. Children should be supervised to ensure that they do not play with the appliance.
5. Always disconnect the plug from the power outlet when the appliance is not in use.
6. **Do not operate the appliance with a damaged cord or plug, after faulty operation, or when it has been dropped or damaged in any way. Contact the nearest authorized service facility for examination, electrical or mechanical adjustment, or repair.**
7. Do not use the appliance outdoors.
8. This heater is not intended for use in bathrooms, laundry areas, or similar indoor locations. Never position the appliance where it may fall into a bathtub or come in contact with water.
9. Do not run the power cord under carpeting. Do not cover cord with throw rugs, runners, or the like. Keep the cord away from any passageways where it could be tripped over.
10. To completely turn off the appliance, push the ON/STAND-BY button (A), and then unplug the heater.
11. Do not wrap the cord around the appliance immediately after use.
12. Do not insert or allow foreign objects to get into the air intakes or exhaust vents, as this may cause electric shock or fire, or damage the appliance.
13. To prevent a possible fire, do not block air intake or exhaust in any way. Do not use the appliance on soft surfaces, such as beds, where the openings may become blocked.
14. Do not cover the appliance while it is functioning in order to avoid overheating and the risk of fire.
15. The internal parts of the appliance can become very hot or produce sparks during operation. Do not use the appliance in areas where gasoline, paints, or other flammable liquids are used or stored.
16. Use this appliance only as described in this manual. Any other use not indicated by the manufacturer may cause fire, electric shock, or injury to persons.
17. To prevent current overload and blown fuses, make sure that no other appliance is plugged into the same outlet or into another outlet wired into the same circuit.
18. It is normal for heater's plug and cord to feel warm to the touch. However, an excessively hot or deformed plug or cord is not normal and may be the result of a defective electrical outlet. Defective outlets must be replaced before using the heater. Plugging the heater into a worn outlet may result in overheating of the power cord or may cause the risk of fire.
19. If the supply cord is damaged, to reduce the risk of malfunction it must be replaced by the manufacturer, its service agent, or a licensed and qualified professional.
20. Do not use this appliance with an extension cord or outlet strip. Connect the appliance directly to a suitable outlet.
21. Make sure that the plug is fully inserted into the outlet. Wall outlets may deteriorate with time, so check the plug periodically for signs of overheating or deformation. If the outlet has deteriorated, stop using it and have it repaired.
22. Check that neither the appliance nor the power cord have been damaged during shipping.
23. Make sure that no styrofoam or other packing materials remain wedged between one element and another of the appliance.
24. The first time the appliance is used, run it at the maximum power for at least two hours. During this time, ventilate the room thoroughly to eliminate the "new" smell released by the appliance. It is completely normal for the appliance to emit "creaking" sounds the first time it is run.
25. **CAUTION: To prevent electric shock, make sure the wide prong of the plug is inserted in the wide slot of the outlet.**

SAVE THESE INSTRUCTIONS

ELECTRICAL CONNECTION



Before connecting the plug to the power outlet, make sure that the voltage of your electrical system corresponds to the voltage shown on the appliance rating label and the outlet you are going to use is in good condition.

INSTALLATION

The appliance may be used on any rigid horizontal surface. Do not overload the electrical circuit; avoid using the same outlet for multiple appliances.

OPERATION AND USE

1. Connect the appliance to the power outlet.
2. The appliance emits a beep and the power indicator light (**H**) comes on and remains on as long as the appliance is powered.
3. The appliance goes into STAND-BY and the display shows "--".
4. Press the ON/STAND-BY button (**A**)  to turn on the appliance. It will begin to heat with the predefined settings.
5. Press the MODE button (**E**) to select one of the following functions available:

Heating () → , Ventilation () → , Anti-freeze ().

5.1 Heating ()

In this operating mode you can set the desired temperature by pressing the + and - adjustment buttons (**B**) and selecting one of the power levels: **MIN**, **MAX**, and **AUTO** using the power selector button (**D**) ().

MIN power level:

The appliance operates at the minimum power, reducing noise and energy consumption to the minimum.

MAX power level:

The appliance operates at the maximum power for rapid heating of the room.

AUTO power level:

The appliance automatically determines the operating power based on the ambient conditions.



5.2 Ventilation ()

In this operating mode only the fan operates, so the appliance does not heat the room.

Press the power selector button (**D**) () to select the desired ventilation speed: **MIN** or **MAX**.

5.3 Anti-freeze ()

In this operating mode the appliance keeps the room at a temperature of 45°F (7°C) to prevent freezing temperatures.

6. If you want the appliance to distribute the airflow over a larger area, press the oscillation button (**C**) (). The appliance will then oscillate right and left. To stop the oscillation in the desired position, just press oscillation button (**C**) again.
7. To turn off the appliance press the ON/STAND-BY button (**A**)  and remove the plug from the outlet.

24-HOUR DIGITAL TIMER

This function can be activated from any operating mode.

NOTE: The display can show the temperature in both °F and °C. To select, press and hold the + key for at least 5 seconds, then release.

Delayed switch-on: With the appliance in STAND-BY mode, press the timer button (**F**) ().

The display shows the symbol () and the time remaining before switch-on. To set the timer, use the + and - adjustment buttons (**B**), then wait a few seconds for the programming to be set.

The display returns to showing "--" for stand-by and the symbol () to indicate you have set the timer. When the programmed time has been reached, the appliance turns on with the same settings it had during the previous operation.

Delayed shut-off: With the appliance on, press the timer button (**F**) (). The display shows the

symbol (⏸) and the time remaining before shut-off.

To set the timer, use the + and - adjustment buttons (B), then wait a few seconds for the programming to be set. The display returns to showing the current settings and the symbol (⏸) to indicate you have set the timer. When the programmed time has been reached, the appliance shuts off automatically. If you want to go back to operation without the timer, press the timer button (F) twice. The timer symbol (⏸) disappears from the display.

USING THE REMOTE CONTROL

- The remote control functions correspond to those on the control panel. See the section "Operation and Use" on the previous page for a description of the functions.

INSERTING OR REPLACING THE BATTERIES

- Remove the cover on the rear of the remote control;
- Insert two AAA (R03/1.5V) batteries (included but packaged separately) making sure they are in the correct position (see the instructions inside the battery compartment);
- Replace the cover.
- Old batteries must be removed and disposed of in accordance with current legislation as they are harmful to the environment.

MAINTENANCE

- Before carrying out any maintenance, always remove the plug from the power outlet.
- **During the season when the appliance is being used, regularly clean the air intake and outlet grilles using a vacuum cleaner.**
- Never use abrasive powders or solvents to clean the appliance.
- Remove the back grille by pulling it outward (Fig. 1). Remove the dust filter that filters impurities from the air taken in from the room, blow it lightly, then reposition it in the appliance.

WARNINGS

- Never use this heating appliance in the immediate vicinity of a bathtub, shower, or swimming pool.
- Use the appliance always and only in the vertical position.
- Do not use the appliance to dry laundry, and do not obstruct the air intake and outlet grilles (danger of overheating).
- Do not operate the appliance in contact with walls, furniture, curtains, etc.
- If the power cord is damaged, it must be replaced by the manufacturer, the authorized service facility, or a qualified electrician, in order to prevent the risk of malfunction.
- Do not cover the appliance while it is operating, as this could potentially cause a fire.
- Do not use this appliance in a room smaller than 43 square feet (4 m²).
- Heaters should never be used with an extension cord or outlet strip. Heaters should be plugged directly into an outlet.

Additional safety features

1. **Overheating protection:** a safety device switches the fan heater off if it **accidentally overheats** (e.g. air intake and outlet grilles obstructed, motor not turning or turning slowly). To restore normal operation, remove the plug from the power outlet and leave it unplugged for a few minutes, eliminate the cause of overheating, then plug the fan heater back in again.
2. **Tip over safety switch:** a safety tip-over switch turns the fan heater off if it tips over or is positioned in an improper way that could jeopardize safety.

Note: To avoid overheating the appliance, do not cover it.

TROUBLE-SHOOTING

If the appliance shuts off unexpectedly:

- Check that the appliance is receiving power.
- Check that the appliance is in the vertical position and on a flat surface, as the safety tip-over switch may have been tripped.
- Check the temperature set and the timer. The appliance may be off because the set temperature has been reached or the time set on the timer has elapsed.



LIMITED WARRANTY

This warranty applies to all products with De'Longhi or Kenwood brand names.

What does the warranty cover?

We warrant each appliance to be free from defects in material and workmanship. Our obligation under this warranty is limited to repair at our factory or authorized service center of any defective parts or part thereof, other than parts damaged in transit. In the event of a product replacement or return, the unit must be returned with transportation prepaid. The repaired or new model will be returned at the company expense.

This warranty shall apply only if the appliance is used in accordance with the factory directions, which accompany it, and on an Alternating Current (AC) circuit.

How long does the coverage last?

This warranty runs for one year (1) from the purchase date found on your receipt and applies only to the original purchaser for use.

What is not covered by the warranty?

The warranty does not cover defects or damage of the appliance, which result from repairs or alterations to the appliance outside our factory or authorized service centers, nor shall it apply to any appliance, which has been subject to abuse, misuse, negligence or accidents. Also, consequential and incidental damage resulting from the use of this product or arising out of any breach of contract or breach of this warranty are not recoverable under this warranty. Some states do not allow the exclusion or limitation of incidental or consequential damage, so the above limitation may not apply to you.

How do you get service?

If repairs become necessary, see contact information below:

U.S. Residents:

Please contact our toll free hotline at 800-322-3848 or log onto our website at www.delonghi.com.

For all accessories, spare parts or replacement parts, please contact our parts division at 1-800-865-6330.

Residents of Canada: Please contact our toll free hotline at 1-888-335-6644 or log onto our website at www.delonghi.com.

Residents of Mexico: Please refer to the Limited Warranty statement for Mexico.

Please refer to the back page of the manual for De'Longhi addresses.

The above warranty is in lieu of all other express warranties and representations. All implied warranties are limited to the applicable warranty period set forth above. This limitation does not apply if you enter into an extended warranty with De'Longhi. Some states do not allow limitations on how long an implied warranty lasts, so the above exclusions may not apply to you. De'Longhi does not authorize any other person or company to assume for it any liability in connection with the sale or use of its appliance.

How does state law apply?

This warranty gives you specific legal rights, and you may also have other rights, which vary from state to state.