**MultiModem
MT2834MR6**

User Guide

MultiModem MT2834MR6 User Guide
PN: S000326A

Copyright ©2003 by Multi-Tech Systems, Inc.

All rights reserved. This publication may not be reproduced, in whole or in part, without prior written permission from Multi-Tech Systems, Inc.

Multi-Tech Systems, Inc. makes no representations or warranties with respect to the contents hereof and specifically disclaims any implied warranties of merchantability or fitness for any particular purpose. Furthermore, Multi-Tech Systems, Inc. reserves the right to revise this publication and to make changes from time to time in the content hereof without obligation of Multi-Tech Systems, Inc. to notify any person or organization of such revisions or changes.

Revision	Date	Description
A	12/30/2003	Initial release of MT2834MR6 User Manual on CD.

Trademarks

Trademarks of Multi-Tech Systems, Inc. are as follows: MultiExpress, MultiExpressFax, MultiModem[®], Multi-Tech and the Multi-Tech logo. Windows is a registered trademark of Microsoft Corporation.

Technical Support

France	support@multitech.fr	+33 1-64 61 09 81
India	support@multitechindia.com	+91 124 6340778
U.K.	support@multitech.co.uk	+44 118 959 7774
U.S., Canada	support@multitech.com	(800) 972-2439
Rest of World	support@multitech.com	+763 717-5863

World Headquarters

Multi-Tech Systems, Inc.
2205 Woodale Drive
Mounds View, Minnesota 55112 U.S.A.
(763) 785-3500 or (800) 328-9717
U.S. FAX (763) 785-9874
Technical Support (800) 972-2439
www.multitech.com

Contents

Chapter 1 - Introduction	7
1.1 Introduction	8
1.2 Manual Organization	8
1.3 Description	9
1.4 FCC Regulations for Telephone Line Interconnection	10
1.4.1 FCC Fax Update	10
1.5 Canadian Limitations Notice	11
1.6 Technical Specifications	12
1.7 Power Supply	14
1.8 Modem LED Indicators	15
1.9 Busy Switch	15
1.10 MT2834MR6 Installation Notes	16
1.11 Safety Warnings	16
Chapter 2 - Dialing and Answering	17
2.1 Introduction	18
2.2 Dial-Up Automatic Answering	18
2.3 Dial-Up Handshaking Details	18
2.4 Call Termination	19
Chapter 3 - AT Commands	20
3.1 Working with AT Commands	21
3.1.1 Modes of Operation	21
3.2.2 Command Structure	22
3.3.3 Command Editing	22
3.2 Dialing Commands	26
3.3 Dial Modifier Commands	27
3.4 Phone Number Memory Commands	30
3.5 Configuration Storage and Recall Commands	32
3.6 Modem Response (Result Code) Commands	34
3.7 Online Connection Commands	36
3.8 V.34 Commands	40
3.9 RS-232 Interface Commands	41
3.10 Error Correction and Data Compression Commands	43
3.11 Speed Conversion Commands	45
3.12 Immediate Action Commands	47
3.12 Flow Control Commands	49

3.13	Escape Sequences	52
3.14	Remote Configuration Commands	53
3.15	Line Probe Commands	54
3.16	Diagnostic Commands	55
Chapter 4	- S-Registers	56
4.1	Introduction	57
4.2	S-Registers	57
4.3	Reading and Assigning S-Register Values	63
4.3.1	Examples of Assigning Values	63
4.3.2	Examples of Reading Values	63
4.4	AT Commands Affecting S-Registers	64
Chapter 5	- Error Correction, Data Compression & Speed Conversion	65
5.1	Introduction	66
5.2	How V.42 Detects and Corrects Errors	67
5.3	Data Compression	68
5.4	MNP Classes	68
5.5	V.42 Mode Select Command (#L)	69
5.5.1	#L0 Command	69
5.5.1.1	<i>Originate Mode</i>	69
5.5.1.2	<i>Answer Mode</i>	69
5.5.2	#L1 Command	69
5.5.3	#L2 Command	69
5.5.4	#L3 Command	69
5.6	Modes of Operation	70
5.6.1	Non-Error Correction Mode (&E0)	70
5.6.2	Reliable Mode (&E2)	70
5.6.3	Autoreliable Mode (&E1)	70
5.7	Flow Control	71
5.8	Modem-Initiated Flow Control	72
5.8.1	XON/XOFF Flow Control (&E5)	72
5.8.2	Hardware Flow Control (&E4)	72
5.9	Pacing (&E13)	73
5.9.1	XON/XOFF Pass-Through (&E7)	73
5.9.2	Non-Error Correction Mode Flow Control (&E10 and &E11)	73
5.9.3	Hewlett Packard ENQ/ACK Pacing (&E9)	73
5.10	Compression, Error Correction, Flow Control, and Pacing Commands	74
5.10.1	V.42 Error Correction Modes	74
5.10.2	Modem-Initiated Flow Control	74
5.10.3	XON/XOFF Pass-Through	74
5.10.4	Hewlett Packard ENQ/ACK Pacing	74
5.10.5	Non-Error Correction Mode Flow Control	74

5.10.6	Pacing (Computer-Initiated Flow Control)	74
5.10.7	Data Compression	74
5.11	Result Codes	75
5.11.1	MNP Error Correction	75
5.11.2	LAP-M Error Correction	75
5.11.3	Data Compression	75
5.12	Speed Conversion	75
5.12.1	Baud Adjust (\$BA)	76
5.12.2	Modem Baud Rate (\$MB)	76
5.12.3	Serial Port Baud Rate (\$SB)	77
5.13	Related Commands	78
5.13.1	Autoreliable Buffering (\$A)	78
5.13.2	Maximum Block Size (&BS)	78
5.13.3	Autoreliable Fallback Character (\$F)	78
5.13.4	Retransmit Count (\$R)	79
5.13.5	V.42 Error Correction at 300 bps (\$E)	79
5.14	Summary	79
Chapter 6 - Testing & Troubleshooting		80
6.1	Introduction	81
6.2	Local Analog Loopback Test (V.54 Loop 3)	82
6.2.1	Test Procedure	82
6.3	Remote Digital Loopback Test (V.54 Loop 2)	83
6.3.1	Test Procedure	83
6.4	Local Digital Loopback Test (V.54 Loop 2)	84
6.4.1	Test Procedure	84
Chapter 7 - Warranty & Service		85
7.1	Multi-Tech Systems, Inc. Warranty & Repairs Policies	86
7.1.1	Warranty	86
7.1.2	U.S. and Canadian Customers	86
7.1.3	International Customers (outside U.S.A. and Canada)	87
7.1.4	International Distributors	87
7.2	Repairs	88
7.2.1	Repair Procedures for U.S. and Canadian Customers	88
7.2.2	Repair Procedures for International Customers	88
7.2.3	Repair Procedures for International Distributors	89
7.2.4	Replacement Parts	89
7.3	Technical Support	89
7.4	Internet Site	89
Appendices		90
Appendix A		91
ASCII Conversion Chart		91

Appendix B	92
Dial Pulses	92
Tone Dial Frequencies	93
Appendix C	94
Result Code Summary	94
Appendix D	96
S-Register Summary	96
Appendix E	98
AT Command Summary	98
Appendix F	106
RS-232C Interface Specifications	106
Functional Description of the RS-232C Signals	107
<i>Transmitted Data (TD)</i> — Pin 2	107
<i>Received Data (RD)</i> — Pin 3	107
<i>Request To Send (RTS)</i> — Pin 4	107
<i>Clear To Send (CTS)</i> — Pin 5	107
<i>Data Set Ready (DSR)</i> — Pin 6	107
<i>Signal Ground (SG)</i> — Pin 7	107
<i>Carrier Detect (CD)</i> — Pin 8	107
<i>Test Voltage (+V)</i> — Pin 9	108
<i>High Speed (HS)</i> — Pin 12	108
<i>Transmit Clock (TC)</i> — Pin 15	108
<i>Receive Clock (RC)</i> — Pin 17	108
<i>Data Terminal Ready (DTR)</i> — Pin 20	108
<i>Ring Indicator (RI)</i> — Pin 22	109
<i>External Transmit Clock (XTC)</i> — Pin 24	109
<i>Terminal Busy (OOS)</i> — Pin 25	109
Appendix G	110
Cable and Connector Diagrams	110
APPENDIX H	111
Introduction to MultiTech Escape Methods	111
How to Select an Escape Method	112
<i>Escape Method 1: +++AT<CR></i>	112
<i>Escape Method 2: <BREAK>AT<CR></i>	112
S-Registers and Escape Sequence	113
Aborting an Escape Sequence	113
APPENDIX I	114
Introduction to Remote Configuration	114
Basic Procedure	114
Setup	114
Changing the Passwords	115
Changing the Remote Escape Character	115
Index	116

Chapter 1 - Introduction

1.1 Introduction

Welcome to the world of data communications. You have acquired one of the finest rack-mount intelligent modems available, the MT2834MR6, from Multi-Tech Systems. This owner's manual will help you install, configure, test, and use your modem.

Your MT2834MR6 is designed to operate as an enhanced ITU-T V.34 dial-up modem. As such, it includes the advanced features of Multi-Tech standalone modems, such as the popular MultiModemZDXb.

This manual documents all of the MT2834MR6's features and capabilities, such as autodial, autoanswer, auto-fallback, number linking, option switches, phone number memory, call progress detection, and more. The next section will show you how to use this manual. The contents of each chapter are described, so you will know where to turn for specific information.

1.2 Manual Organization

Chapter 1 Introduction and Description

This chapter describes the MT2834MR6 and its LED indicators, gives its technical specifications, and provides a guide to the organization of the manual.

Chapter 2 Dialing and Answering

This chapter describes answer mode operation in detail, including handshaking procedures between two modems and an autoanswer application. Various methods of call termination are also described.

Chapter 3 Command Mode Operation

This chapter provides an introduction to MT2834MR6 command mode fundamentals, followed by a detailed explanation of each AT command, providing examples where applicable.

Chapter 4 S-Registers

This chapter describes the MT2834MR6's S-registers, which are used to store various modem options. Each S-register is defined and explained.

Chapter 5 Error Correction, Data Compression and Speed Conversion

This chapter provides detailed information about some of the advanced features of the MT2834MR6, namely, V.42 error correction, data compression, speed conversion, and other features that improve throughput.

Chapter 6 Testing the MT2834MR6

This chapter describes loopback testing for the MT2834MR6.

Chapter 7- Warranty, Service, and Technical Support

This chapter provides the terms of the MT2834MR6's warranty, instructions for obtaining factory service, and information about Multi-Tech's BBS and technical support. Information on upgrading the MT2834MR6's firmware is also provided.

Appendices

This chapter includes sections pertaining to ASCII/HEX/Decimal Conversion Chart, Dial Pulses and Tone Dial Frequencies, Result Code Summary, S-Register Summary, AT Command Summary, RS-232 Interface Specifications, Cable and Connector Diagrams, Escape Methods, and Remote Configuration.

1.3 Description

Each MT2834MR6 card contains six integrated 33,600 bps MultiModems. Each modem on the MT2834MR6 card can be configured independently of the others via the MultiModemManager controller card (Model MR4800 or MR4800E), which can support and control up to 16 MultiModem cards per rack. Refer to your MultiModemManager *Owner's Manual* for more information about the rack and its components.

Perhaps the most significant extras incorporated in the MT2834MR6 are its V.42 error correction and V.42bis data compression features. With error correction and data compression, transmission errors are eliminated while increasing the modem's throughput by a ratio of up to 4:1, for an effective overall transmission rate approaching 115,200 bps.

The MT2834MR6 offers interactive automatic dialing capability, as well as command mode option configuration. Two dial command strings, of up to 60 digits each, can be stored in each modem's nonvolatile memory. The modem supports both pulse and tone dialing, and can recognize dial tones and busy signals for reliable call-progress detection.

The MT2834MR6 is registered by the FCC for direct connection to the public telephone networks. No Data Access Arrangements (DAAs) are required.

The MT2834MR6 is fully compatible with the standard AT command set, and is therefore compatible with all popular communications software packages.

1.4 FCC Regulations for Telephone Line Interconnection

1. No repairs are to be made by you. Repairs are to be made only by Multi-Tech Systems or its licensees. Unauthorized repairs void registration and warranty. Contact Multi-Tech Systems, Inc. for details of how to have repairs made.
2. When trouble is experienced, you must disconnect your modem from the telephone company's jack to determine the cause of the trouble, and reconnect your modem only when the trouble is corrected.
3. The modem cannot be connected to pay telephones or party lines.
4. If requested by the telephone company, you must notify them of the following before the MT2834MR6 is installed:
 - a. The particular phone line (phone number) to which the connection is to be made.
 - b. The FCC Registration Number: **AU7USA-30805-MM-E**
 - c. The Ringer Equivalence: **0.3B**
 - d. Modems can only be connected to the phone lines through standard modular jacks. The Uniform Service Order Code (U.S.O.C.) for the standard modular jack which connect the modem to the phone lines are: **RJ-11C or RJ-11W (single line)**
 - e. The manufacturer's name and model number: **Multi-Tech Systems - Model MT2834MR6**
5. If the telephone company notifies you that your device is causing harm, unplug it. The telephone company may disconnect your service if necessary and also may change its facilities, equipment, operations or procedures which may affect operation of your equipment. Where practical, the telephone company must promptly inform you in writing of the temporary disconnect or change in service, give you the opportunity to make changes allowing uninterrupted service, and inform you of your rights to bring a complaint to the FCC.

1.4.1 FCC Fax Update

The Telephone Consumer Protection Act of 1991 makes it unlawful for any person to use a computer or other electronic device to send any message via a telephone fax machine unless such message clearly contains in a margin at the top or bottom of each page or the first page of the transmission, the date and time it is sent and an identification of the business or other entity, or other individual sending the message and the telephone number of the sending machine or such business, other entity, or individual.

See your fax software manual for setup details.

1.5 Canadian Limitations Notice

Notice: The ringer equivalence number (REN) assigned to each terminal device provides an indication of the maximum number of terminals allowed to be connected to a telephone interface. The termination of a interface may consist of any combination of devices subject only to the requirement that the sum of the ringer equivalence numbers of all the devices does not exceed 5.

Notice: The Industry Canada label identifies certificated equipment. This certification means that the equipment meets certain telecommunications network protective, operational and safety requirements. Industry Canada does not guarantee the equipment will operate to the user's satisfaction.

Before installing this equipment, users should ensure that it is permissible to be connected to the facilities of the local telecommunications company. The equipment must also be installed using an acceptable method of connection. The customer should be aware that compliance with the above conditions may not prevent degradation of service in some situations.

Repairs to certified equipment should be made by an authorized Canadian maintenance facility designated by the supplier. Any repairs or alterations made by the user to this equipment, or equipment malfunctions, may give the telecommunications company cause to request the user to disconnect the equipment.

Users should ensure for their own protection that the electrical ground connections of the power utility, telephone lines and internal metallic water pipe system, if present, are connected together. This precaution may be particularly important in rural areas.

Caution: *Users should not attempt to make such connections themselves, but should contact the appropriate electric inspection authority, or electrician, as appropriate.*

Industry Canada Certification Number:
Ringer Equivalence Number (REN): 0.2

1.6 Technical Specifications

Model Number	MT2834MR6
Data Rates (Modem)	Six independent modems (Modem A, B, C, D, E, F), each operating at 33,600, 31,200, 28,800, 26,400, 24,000, 21,600, 19,200, 16,800, 14,400, 12,000, 9600, 4800, 2400, 1200, or 0-300 bps
Data Rates (Fax)	14,400, 9600, 4800, and 2400 bps
Data Format (Modem)	Serial, binary, asynchronous at all data rates
Configuration	Each of the card's six modems is independently configurable
Compatibility (Modem)	ITU-T V.42bis, V.42, V.34, AT&T V.32terbo, ITU-T V.32bis, V.32, V.25bis, V.21, V.22bis, V.22, V.23, V.17, Bell 212A* and 103/113*
Compatibility (Fax)	ITU-T Group 3, T.4, T.30, V.21, V.27ter, V.29, V.17, and EIA TR29.2
Error Correction	ITU-T V.42 (MNP® Classes 3 and 4, and LAP-M)
Data Compression	ITU-T V.42bis (4:1 throughput) or MNP 5 (2:1 throughput)
Speed Conversion	Serial port data rates adjustable to 300, 1200, 2400, 4800, 9600, 19,200, 38,400, 57,600, and 115,200 bps
Flow Control	XON/XOFF, CTS/RTS, ENQ/ACK
Mode of Operation	Half or full duplex over dial-up lines; automatic or manual dialing, automatic or manual answer
Intelligent Features	Fully AT command compatible; autodial; redial; repeat dial*; dial linking*; pulse or tone dial; dial pauses; call status display; auto-parity and data rate selection; keyboard-controlled modem options; nonvolatile memory; on-screen displays of modem parameters, stored telephone numbers, and help menus; and remote configuration.
AT Commands	100% compatible with standard AT command set
Command Buffer	60 characters
Automatic Dialing	Standard AT command asynchronous dialing
Modem Modulations	FSK at 300 bps, PSK at 1200 bps, QAM at 2400, 4800, and 9600 bps (non-trellis), QAM with trellis-coded modulation (TCM) at 9600, 12,000, 14,400, 16,800, 19,200, 21,600, 24,000, 26,400, 28,800, 31,200, and 33,600 bps
Fax Modulations	V.21 CH2 FSK at 300 bps V.27ter DPSK at 4800 and 2400 bps V.29 QAM at 9600 and 7200 bps V.17TCM at 14400, 12000, 9600, and 7200 bps
Carrier Frequencies	1600, 1646, 1680, 1800, 1829, 1867, 1920,
ITU-T V.34	1959, 2000 Hz
Carrier Frequencies:	1800 Hz
AT&T V.32 terbo/ ITU-T V.32bis/V.32	
Carrier Frequencies:	Transmit originate: 1200 Hz
V.22bis/V.22 or	Transmit answer: 2400 Hz
Bell 212A Standard	Receive originate: 2400 Hz
(2400 & 1200 bps)	Receive answer: 1200 Hz

Carrier Frequencies: Bell 103/113 (300 bps)	Transmit originate:	1270 Hz mark 1070 Hz space
	Receive originate:	2225 Hz mark 2025 Hz space
	Transmit answer:	2225 Hz mark 2025 Hz space
	Receive answer:	1270 Hz mark 1070 Hz space
Carrier Frequencies: V.21	Transmit originate:	980 Hz mark 1180 Hz space
	Receive originate:	1650 Hz mark 1850 Hz space
	Transmit answer:	1650 Hz mark 1850 Hz space
	Receive answer:	980 Hz mark 1180 Hz space
Carrier Frequencies: V.23	Transmit originate:	390 Hz mark 450 Hz space
	Receive originate:	1300 Hz mark 2100 Hz space
	Transmit answer:	1300 Hz mark 2100 Hz space
	Receive answer:	390Hz mark 450Hz space
Fax Modulations	V.21Ch2 FSK at 300 bps	
	V.27ter DPSK at 4800 and 2400 bps	
	V.29 QAM at 9600 and 7200 bps	
	V.17 TCM at 14400, 12000, 9600, and 7200 bps	
	V.21 CH2 (half duplex)	
Fax Carrier Frequencies	1650 Hz mark, 1850 Hz space for transmit originate	
	1650 Hz mark, 1850 Hz space for transmit answer	
	V.27ter: 1800 Hz Originate/Answer	
	V.29 QAM: 1700 Hz Originate/Answer	
	V.17 TCM: 1800 Hz Originate/Answer	
Transmit Level	-13 dBm	
Frequency Stability	+0.01%	
Receiver Sensitivity	-43 dBm under worst case conditions	
AGC Dynamic Range	43 dB	
Serial Interface	EIA RS-232C	
Diagnostics	Power-on self-test; ITU-T V.54 local analog loop, local digital loop, remote digital loop.	

Firmware Upgrades	Via flash PROM technology on Multi-Tech's BBS
Indicators	LEDs for Transmit Data, Receive Data, Carrier Detect, Speed, and Off Hook/Out-Of-Service
Controls	Toggle switches for busy-out
Environmental	Temperature range: 0°–50° C (32°–120° F) Humidity range: 20–90% (noncondensing)
Power Requirements	5 VDC at 0.95 A ±16 VDC at 0.1 A
Power Consumption	Approximately 6 watts
Dimensions, card modem	.9 x 11 x 15 in. (2.2 x 28 x 37 cm) H x W x D
Weight	2.5 lb. (1.1Kg)
Limited Warranty	Two years
Fuses	F1 (+5V), F2 (-16V), F3 (+16V)

1.7 Power Supply

DC voltages are supplied to all modems in the CC4800A rack through one or two PS4800A power supplies, designed for conventional 115 or 230 VAC connection. The power supply is a universal input switching power supply.

1.8 Modem LED Indicators

The MT2834MR6 has five LED indicators per modem:

TD Transmit Data. This LED blinks when data is being transmitted, on for a space, off for a mark. The state of this LED matches that of the TD circuit on Pin 2 of the RS-232C interface.

RD Receive Data. This LED blinks when data is received, on for a space, off for a mark. The state of this LED matches that of the RD circuit on Pin 3 of the RS-232C interface.

CD Carrier On. This LED lights when a valid carrier tone has been detected.

Speed Speed. This LED blinks at different rates to indicate the speed of the data connection:

<u>Data Rate (bps)</u>	<u>LED State</u>
12000 or less	Off
14400 or 16800	Slow blink rate
19200 or 21600	Medium blink rate
24000 or 26400	Fast blink rate
28800 or more	On

OH/OOS Off Hook/Out of Service. This LED lights when the modem is off hook, which occurs when the modem is dialing, online, or answering a call. The LED flashes when the modem is in the busy-out or out-of-service state.

Note: *The PS4800 modem rack power supply has one LED that indicates the presence of all supply voltages.*

1.9 Busy Switch

The MT2834MR6 has six two-position Busy switches on the front panel. Each switch can be used to create a “busy-out” (OOS) condition for one of the six on-board modems (i.e., modem A, B, C, D, E, or F).

To place a modem in the Busy condition, move the appropriate Busy switch to the right. The selected modem goes off-hook, its OH/OOS LED begins to flash, and incoming calls to this modem get a busy signal. If you suspect a problem with a particular modem, you can use the Busy switch to have an optional device (such as a “hunt group”) that looks for a non-busy line to perform a rollover to the next available modem while you check the status of the Busy modem.

Note: *The MultiModemManager can perform the same function using software.*

1.10 MT2834MR6 Installation Notes

All installation must be done by a qualified service person.

The installation instructions in your MultiModemManager *Owner's Manual* include information about the use of blanking plates to cover empty slots in the card frame. Be sure to follow those instructions.

Warning: *Interconnection directly, or by way of other apparatus, of ports marked "SAFETY WARNING see instructions for use" with ports marked or not so marked may produce hazardous conditions on the network. Advice should be obtained from a competent engineer before such a connection is made.*

This product is intended to be hard wired to the network. The final connection to the network is the responsibility of the public telecommunications network operator or a person authorized by that operator.

Any other apparatus, including cable and wiring, connected between the MT2834MR6K modem and the point of connection to any speechband circuit shall comply with the following:

1. The overall characteristics of this apparatus shall be such as to introduce no material effect upon the electrical conditions presented to one another by the modem and the speechband circuit.
2. The apparatus shall comprise only
 - a. apparatus approved for the purpose of connection between the modem and a speechband circuit; and
 - b. cable and wiring complying with a code of practice for the installation of equipment covered by this part of BS 6328 or such other requirements as may be applicable.

Note: *Such apparatus may have been approved subject to limitations in its use.*

1.11 Safety Warnings

- Never install telephone wiring during a lightning storm.
- Never install telephone jacks in wet locations unless the jacks are specifically designed for wet locations.
- Never touch uninsulated telephone wires or terminals unless the telephone line has been disconnected at the network interface.
- Use caution when installing or modifying telephone lines.
- Avoid using a telephone (other than a cordless type) during an electrical storm. There may be a remote risk of electrical shock from lightning.
- Do not use the telephone to report a gas leak in the vicinity of the leak
- Ports that are connected to other apparatus are defined as SELV. To ensure conformity to EN 41003, ensure that these ports are only connected to the same type on the other apparatus.

Chapter 2 - Dialing and Answering

2.1 Introduction

This chapter describes the dialing and answering capabilities of the MT2834MR6 modems, which are standard ITU-T V.34 full duplex dial-up modems.

2.2 Dial-Up Automatic Answering

The MT2834MR6 can answer calls automatically. The MT2834MR6 is in originate mode in its idle state. When it detects an incoming call, it automatically switches to answer mode. You can program the modem to answer a call after a certain number of rings by using register **SO** (see Chapter 4).

2.3 Dial-Up Handshaking Details

This section briefly explains what happens between two modems in a normal call. We are assuming that there are MT2834MR6s at both the originating and at the answering end of the telephone line. (If other brands of modems are used with our modems, they will still communicate, but each manufacturer tends to use slightly different delay timings and sequences, and many of the brands vary in their indicator designations.)

Before V.34 negotiation takes place, remote and local modems transfer their functional capabilities using modulated calling and answering tones. First, the Calling Menu (CM), a data sequence using V.21 low-band modulation (a handshaking technique originally developed for 300 bps modems), is sent from the originating V.34 modem to the answering V.34 modem. This describes the range of functional capabilities the originating modem supports. The answering V.34 modem responds to the CM with a Joint Menu, or JM (using V.21 high-band modulation), indicating the common capabilities of the modem at each end.

Once this is done, a probing signal is passed between the modems to identify impairments in the telephone channel. After receiving the results of the probing signal, the modem receivers and transmitters will start with the lowest speed and move up until reaching the highest speed at which they can exchange data. All this occurs in about five seconds.

Note: In order for the called modem to be able to answer the call, it must have a high DTR (Data Terminal Ready) signal on pin 20 of the RS-232C interface. This signal comes from the computer or terminal to which the modem is connected.

Note: If you are using reliable or auto-reliable mode, some additional handshaking takes place. This is explained in Chapter 5, in the "Auto-Reliable Mode" section.

2.4 Call Termination

There are several methods by which you can terminate a call, or simply stated, hang up:

1. **Command Mode Control.** It is possible to enter command mode while remaining online by entering an escape sequence (**+++AT<CR>** in most cases). From command mode, you can return to the online state by typing **ATO**, or you can terminate the call by using the **H** command. Typing **ATH** will hang up the line (bring it on-hook). So the command to hang up a call is three plus signs followed by **ATH**.
2. **DTR Control.** If DTR (Data Terminal Ready) is turned off for 50 milliseconds or more, a disconnect will occur. This is probably the most common method used by computer systems at the autoanswer end of the line to cause the calling modem to disconnect after logoff procedures.
3. **Loss of Carrier.** Once a data connection has been established, the modem will disconnect if a loss of carrier occurs for 700 milliseconds (0.7 seconds) or longer. This time can be configured with register **S10** for any time from 0 to 25.5 seconds (in 100 mSec increments). Note that one cause of carrier loss would be if one of the modems were to disconnect normally. **S10** works for speeds of 2400 bps or below. **S10** has no effect at connections above 2400 bps.
4. **Abort Timer.** Answer Mode: When OH (Off Hook) comes on, the called modem starts a 45 second timer and waits for a carrier signal from the originating modem. If a carrier is not detected within this period, the modem disconnects (hangs up) and is ready for another call. Originate Mode: The abort timer functions the same as in the answer mode, except that the timer begins after the modem has completed dialing, instead of when it first goes off hook. It is possible to change this 45-second wait period to any other value from 1 second up to 254 seconds by reconfiguring register **S7** (see Chapter 4).
5. **Inactivity Timer.** Causes the modem to disconnect if no data is being transmitted or received for a certain period of time. The timer is reset anytime a character passes through the serial port in either a send or receive direction. This function is controlled by register **S30**. The inactivity timer can be disabled by setting **S30** to 0, which is the factory default setting, or set to time out after number of minutes selected by register **S30**.

Chapter 3 - AT Commands

3.1 Working with AT Commands

The MT2834MR6's modems are controlled by instructions called AT commands, so called because the attention characters AT precede each command or command string (sequence of commands). You can send commands to the modem from your keyboard while in terminal mode, or you can use communications software to issue these commands automatically.

The MT2834MR6 is in command mode when it is not dialing or online. When it is in command mode, you have access to a complete communications system that allows you to use several features, including the basic AT command set described in this chapter. Using the basic AT command set, you can enter phone numbers for automatic dialing, configure modem options, and monitor telephone activity. In addition, you can command your modem to perform advanced features such as error correction, data compression, speed conversion, and more.

This chapter explains command mode, and shows you how to use each of the MT2834MR6's AT commands. MT2834MR6 commands and responses are compatible with all systems and with all data communications software using the AT command set.

For easy reference, the MT2834MR6 has a help command that provides you with short, on-screen descriptions of the modem commands. The help command is explained later in this chapter.

3.1.1 Modes of Operation

The MT2834MR6 operates in two basic functional modes: command mode and online mode. (There is also an in-between state, wait-for-carrier, in which the modem is out of command mode but not yet online.) When you power up the modem, it is in command mode, and is ready to accept and respond to commands from your keyboard or software.

An MT2834MR6 modem enters online mode after it dials, connects with another modem, and detects a valid carrier signal. If it does not detect a carrier signal within the time frame controlled by register **S7**, the modem abandons the call and re-enters command mode.

You can make the modem enter online mode without dialing by typing either the **D** command or the **A** command.

The modem exits online mode if the carrier signal is lost or intentionally dropped. When this happens, the modem hangs up and re-enters command mode.

By sending certain "escape" characters to the modem while online, you can make it enter command mode without losing the carrier signal.

For autoanswer-only applications, you can disable a modem's ability to recognize AT commands by using the **%DC1** command. When you do this, the MT2834MR6 ignores all commands, and functions as a non-intelligent modem. The **%DC1** command and other MT2834MR6 commands are explained later in this chapter.

3.2.2 Command Structure

You can control a wide variety of modem operations and options when the modem is in command mode. AT commands tell the modem to dial a number, to answer a call, to operate at a certain speed, to use a certain compression technique, and many other functions. AT commands consist of one or two letters, which may be preceded by an ampersand (&), a dollar character (\$), a pound character (#), a percent character (%), or a greater-than character (>). The **Q** command, for example, determines whether the modem returns result codes, while the **&Q** command selects which AT command set the modem uses.

A parameter after a command (0, 1, 2, etc.) tells the modem which option to use. If you do not specify a parameter, the modem assumes the 0 (zero) option. **E**, for example, is the same as **E0**. You can issue several commands on a single line (a command string) as long as the line does not exceed 60 characters. Note that though **Q1** is one command, it counts as two characters in the command line.

Each command has a valid range of parameters; for instance, **&W** can have only 0 or 1 as a parameter. Valid commands generate an OK result code. A few generate an additional response, such as a list of parameters. An invalid command, such as **&W3**, which has a parameter outside the valid range, generates an ERROR result code. Most commands have a default parameter, one that is enabled when the modem is turned on or reset with the **ATZ** or **AT&F** command. Factory defaults are stored in read-only memory (ROM), and cannot be changed. User-defined defaults can be stored in nonvolatile random-access memory (NVRAM), and can be changed or deleted at will.

3.3.3 Command Editing

Always begin a command with the letters AT. You may type the command in upper case or lower case, but not both. The AT command is not executed until you press the ENTER key. Use the BACKSPACE key to erase the previous command character; it will not erase the AT characters once they are typed. If your keyboard has no BACKSPACE key, use CTRL+H. You can change the character recognized by the modem as BACKSPACE to any other ASCII character by changing register **S5**.

To cancel an entire command that has been typed but not yet executed, press CTRL+X. This also clears the command buffer. The effect is the same as backspacing the command, only quicker.

The MT2834MR6 stores characters entered in a command in the modem's command buffer until they are executed by pressing ENTER. The command buffer's capacity is 60 characters. The attention characters (AT) do not count in the 60 allowed command characters. You may use spaces for increased readability when typing a command; they are neither stored in the command buffer nor counted in the 60 allowed characters. Hyphens, parentheses, etc., are not allowed.

If you exceed the 60-character limit or type invalid characters, the command buffer is automatically erased and an ERROR message is displayed. You must then retype the command within the 60-character limit, using only the allowed characters.

The commands in this chapter are organized by function. A brief summary follows.

Table 3-1. AT Commands by Function

Topic:	Command:	Description:
Dialing Action	D	Dial
	A:	Continuous redial
	H	On-hook/off-hook
Dial Modifiers	P	Pulse dialing
	T	Tone dialing
	W	Wait for new dial tone
	R	Reverse originate/answer mode
	,	Dialing pause
	:	Continuous redial
	;	Return to command mode after dialing
	!	Flash on-hook
	@	Quiet answer
\$	Call card tone detect	
Phone Number Memory	D...N	Store a phone number
	N	Dial a stored number
	N...N	Number linking
	L	List stored telephone numbers
Configuration Storage & Recall	&W	Store configuration
	&F	Load default configuration
	Z	Reset modem
Modem Responses (Result Codes)	E	Echo command mode characters
	Q	Result codes: enable/disable
	&Q	Result codes: Multi-Tech or standard
	V	Result codes: verbose/terse
	X	Result codes and call progress
&A	Answerback	
Online Connection	#A	Auto speed detection
	B	Answer tone
	%DC	Command mode control
	&CD	Cleardown at disconnect
	>DT	DTMF detection
	#F	Fallback modes when online
	&G	Guard tones
	*H	Busy-Out After Disconnect
	&P	Pulse dial ratios
	&RD	Square wave ring detect
	\$T	Calling tones
	#T	Trellis-coded modulation
	Y	Long space disconnect

Table 3-1. AT Commands by Function (con't)

Topic:	Command:	Description:
V.34 Controls	%F	Echo canceler frequency offset comp.
	&RA	Asymmetric bit rate
	#V	V.32terbo handshake
RS-232 Interface Controls	&C	Carrier Detect control
	&D	Data Terminal Ready control
	&R	Clear to Send control
	&S	Data Set Ready control
	&RF	CTS/RTS interaction control
	&SF	DSR/CD interaction control
Error Correction & Data Compression	&E0	Non-error correction mode
	&E1	Autoreliable mode
	&E2	Reliable mode
	&E14	Data compression disabled
	&E15	Data compression enabled
	#L	V.42 error correction modes
	\$E	V.42 error correction at 300 bps
	\$A	Autoreliable buffering
	\$F	Autoreliable fallback character enable
	\$R	Retransmit count
Speed Controls	\$BA	Baud adjust
	\$MB	Modem baud rate
	\$SB	Serial port baud rate
Immediate Action	A/	Repeat last command
	I	Inquire product code
	L5	List current operating parameters
	L6	List S-register values
	L7	List current operating parameters
	L8	List online diagnostics
	&RN	Rate renegotiation
	&RR	Retrain
Flow Control	&BS	Maximum reliable block size
	\$EB	Asynchronous word length (10/11-bit)
	&E3	Flow control disabled
	&E4	Hardware flow control
	&E5	XON/XOFF flow control
	&E6	XON/XOFF no pass-through
	&E7	XON/XOFF pass-through
	&E8	Hewlett Packard ENQ/ACK pacing off
	&E9	Hewlett Packard ENQ/ACK pacing on

Table 3-1. AT Commands by Function (con't)

Topic:	Command:	Description:
	&E10	Non-error correction mode flow control off
	&E11	Non-error correction mode flow control on
	&E12	Pacing off
	&E13	Pacing on
	#X	Number of XOFF characters sent
Escape Sequences	+++AT<CR>	Default in-band escape sequence
	<BREAK>AT<CR>	Alternate out-of-band escape sequence
	%E	Escape sequence selection
	A	Force answer mode
	O	Go back online
Remote Configuration	%%AT<CR>	Remote configuration escape sequence
	#I	Change login password
	#S	Change setup password
Line Probes	%DP	Read line probe data
	%DF	Format line probe data
	&RP	Immediate line probe
	L9	Display signal strength
	L10	Display signal to noise ratio
	L11	Display noise strength
Diagnostics	&T	Respond to remote digital loopback signal
	U	Loopback test modes

3.2 Dialing Commands

Dialing commands are used to dial and to hang up.

- Ds** **Dial**
s = phone number
Default: none
- The letter **D** in a command causes the modem to dial the telephone number immediately following it. For example, if you type **ATD5551212<CR>**, the modem dials the number 555-1212.
- The MT2834MR6 supports several dialing methods. With the **D** command, you can specify either pulse (**ATDP**) or tone (**ATDT**) dialing. You can also modify the dialing command with several characters that are explained in "Dial Modifier Commands" in this chapter.
- The MT2834MR6 lets you select either smart (wait-for-dial-tone) dialing or blind dialing. With smart dialing, the modem waits for and detects dial tones and busy signals. With blind dialing, the modem works with timed pauses (determined by the value of register **S6**), not dial tone and busy signal detection. See the **X** command for more information on blind and smart dialing.
- A:** **Continuous Redial**
- If you select smart dialing through the **X3** or **X4** command, the **A:** command lets you continuously redial a busy number until your call is answered. (North American units have a maximum of 10 redials; this command is not available on U.K. or International models.) Use this command only if you have reached a busy number after executing a normal dial command. Type **A:** (you need not type AT, nor do you need to press ENTER), and the modem redials the number. If you again reach a busy signal, the modem continues to redial until it gets through. You can stop the modem from redialing by pressing any key.
- To save a step when redialing a phone number, enter a colon (:) at the end of the phone number. The result is the same as if you had entered **A:**

Note: This command has been largely superseded by software-based continuous redial features.

- Hn** **On-Hook/Off-Hook**
n = 0 or 1
Default: none
- You can make the modem go on-hook (hang up) or go off-hook with the **H** command. **H0** (or **H**) hangs up the modem. **H1** brings the line off-hook, just as if you had picked up the telephone handset.
- It is not necessary to use the **H1** command to bring the line off-hook when using the **D** command. The modem automatically goes off-hook when you press ENTER at the end of the dial command.

3.3 Dial Modifier Commands

The dial string can include the digits 0 through 9, the pound sign (#), the asterisk (*), and the letters A, B, C, or D. The latter are used by some PBXs; the exact function will depend on the PBX manufacturer's feature set and implementation. There are also several command characters, called "dial modifiers," that can be included within a dialing command after the letter D. Their functions include pulse or tone dialing, pauses in the dial sequence, automatic redials if a number is busy, and reverting to command mode or switching to answer mode after dialing.

P, T **Pulse or Tone Dialing**

Default: P

The MT2834MR6's modems can dial numbers by using pulse dialing, tone dialing, or a combination of both methods. Pulse dialing, used by rotary-dial telephones, uses the timed opening and closing of a relay to encode the numbers. Tone dialing, used by push-button (touch-tone) telephones, uses dual tone multifrequency (DTMF) dialing.

P selects pulse dialing.

T selects tone dialing.

Insert **P** or **T** in the dialing command just before the digits you want to pulse- or tone-dial. For example, to pulse-dial the number 555-1212, type **ATDP5551212** and press ENTER. To tone-dial the same number, type **ATDT5551212** and press ENTER. If neither pulse nor tone dialing is specified in the dial command, the modem uses whatever method was used last.

Immediately after the modem has been turned on or reset, it uses pulse dialing, even if you do not include **P** in your dial command.

As an example of combining pulse and tone dialing, assume you are calling out of a PBX (switchboard) system where a 9 has to be pulse-dialed, then the rest of the number has to be tone-dialed after pausing for a second dial tone. To dial this example, type **ATDP9,T5551212** and press ENTER. (The comma causes a pause.)

W **Wait for New Dial Tone**

Inserting **W** into the dialing command causes the modem to wait for another dial tone before it resumes dialing. (It is not necessary to enter **W** at the beginning of the dialing command.) Because the modem must be able to detect the dial tone for this command to work, you also must select wait-for-dial-tone dialing with the **X2** or **X4** command.

Rn **Reverse Originate/Answer Mode**

n = 0 or 1

Default: R0

The **R** command lets you reverse the modem's mode of operation from originate to answer, or from answer to originate; for example, if you need the modem to answer the phone but then go into originate mode.

R (with no number) at the end of the dialing string reverses in originate mode.

R0 disables mode reversing.

R1 enables mode reversing when **R** is added to the dial string.

Dialing Pause

Enter a comma in the dialing string to make the modem pause while dialing. This pause lasts two seconds (North American models) or four seconds (U.K. and International models) for each comma entered. You can force longer pauses by entering multiple commas, or you can change the length of the pause caused by a comma by setting register **S8** to any value from 0 through 255 seconds (North American models), 4 through 7 seconds (U.K. models) or 4 through 255 seconds (International models).

Each comma in a dialing command counts as one of the 60 allowed characters.

Continuous Redial

Enter a colon (:) as the last character of a dialing command, to cause the modem to continuously redial the number, if it detects a busy signal, until the call is answered. North American models are limited to 10 redials. You must select smart dialing (**X3** or **X4**) for this to work. (Not available in U.K. or International models.)

Note: This command has largely been superseded by software-based continuous redial features.

Return to Command Mode After Dialing

Enter a semicolon (;) as the last character of a dialing command to cause the modem to return to command mode immediately after executing the command instead of waiting for a carrier signal and going online.

For example, type **ATDT5551212;** to tone-dial the number and immediately go back into command mode. The semicolon is useful when modem data transfer is not desired, as in voice communications, or in applications using touch tones as a data entry method, such as bank-by-phone.

Flash On-Hook

Some switchboard systems react to a momentary on-hook condition. Insert an exclamation mark into the dialing command to cause the modem to “flash” on-hook for half a second, just as if you had pressed the switch hook on a telephone set for half a second. (With U.K. models, the exclamation mark causes the modem to flash on-hook for 90 milliseconds.)

For example, to flash on-hook to transfer to extension 5678 after dialing the number 555-1234, type **ATDT5551234,,15678**. The commas cause a 4-second pause.

Quiet Answer

Use the @ command to access a system that does not provide a dial tone. The @ command causes the modem to wait before processing the next character in the dialing string. The wait is for one or more rings back followed by five seconds of silence.

For example, **ATDT5551212@6313550** causes the modem to dial the first number (555-1212), then wait for the time specified in register **S7** for at least one ringback and five seconds of silence. If the modem detects a busy signal, it hangs up and generates a BUSY result code. If it does not detect five seconds of silence, it hangs up and generates a NO ANSWER result code. If it does detect five seconds of silence, it dials the second number (631-3550).

\$

Call Card Tone Detect

Use the **\$** command to dial services that require you to enter your call card number after a tone. A **\$** character in the dialing string causes the modem to pause and wait for an AT&T call card “bong” or a 1600 Hz tone (prevalent in the U.K.). When the modem detects the tone, it processes the rest of the dialing string. If it does not detect a tone within the time set by register **S7** (a 45-second default), the modem aborts with a NO CARRIER message. Pressing any key also aborts the **\$** command.

In the following example, the **\$** command is placed between an access/phone number and the caller’s credit card number:

ATDT1028806127853500\$123456789

3.4 Phone Number Memory Commands

The modem can store up to two telephone numbers in nonvolatile memory. You can store the numbers with the **DsNd** command, dial them with the **Nd** command, link them so that one will be automatically dialed after the other with the **NdNe** command, or list them with the **L** command.

DsNd Store a Phone Number

s = phone number

d = 0 or 1

Default: none

You can store a telephone number command string of up to 60 characters in the modem's phone number memory. You can store two of these 60-character strings using the **DsNd** command. The memory locations are labeled N0 and N1.

Store a command line by typing it as you would any other command, appending the appropriate Nd memory location.

For example, the tone-dialed number 1-612-555-1212 is stored at memory location N0 by typing **ATDT16125551212N0** and pressing ENTER. The number is not dialed with this store command.

After storing a number, check to see that it has been stored correctly by typing **ATL** and pressing ENTER.

When you store a phone number, you store the entire command string, so you can effectively create a macro for each number. For example, if you know a particular number needs to have extended result codes, detect busy or dial tone, error correction, XON/XOFF flow control, pacing, and data compression enabled, the command to store the entire command string at location N0 is **ATX4&E1&E5&E13&E15DT16125551212N0**.

Nd Dial a Stored Number

d = 0 or 1

Default: none

You can automatically dial a telephone number that is stored in the modem's number memory by typing **ATNn**, where n = 0 or 1. For example, you can dial a number stored at N0 by typing **ATN0** in terminal mode and pressing ENTER.

Warning: Do not include the letter D in this command, or the stored number will be erased.

NdNe Number Linking

d = 0 or 1

e = 1 or 0

Default: none

Number linking allows the modem to dial a second stored number if the first stored number is busy. (See the **DsNd** command.) This command is useful when a computer can be accessed through more than one phone number. However, it cannot be used with blind dialing, since busy signals would not be detected.

To link the number in memory location N0 to the number in N1, type **ATNON1** and press ENTER. You can cycle back and forth between two numbers by linking them several times in one command: **ATNON1NON1NON1<CR>**. The only limit on the number of times the modem can cycle between two numbers is the 60-character maximum allowed in a command line.

L **List Stored Telephone Numbers**

Use the **L** command to display dialing commands stored in the modem's nonvolatile memory. Typing **ATL<CR>** displays the stored N numbers in the following format:

```
0      T14082345678
1      P9,T14089876543
```

All digits and command letters are displayed. The N number is shown first, followed by the complete dialing command and telephone number as originally entered.

3.5 Configuration Storage and Recall Commands

The MT2834MR6 stores parameters in two places. It stores factory default parameters in read-only memory (ROM), and customized parameters in nonvolatile random access memory (NVRAM). You cannot change the default parameters in ROM; however, you can change parameters in temporary memory and then store them in NVRAM as custom settings. You can then recall the custom settings as if they were factory default settings.

&Wn Store Configuration

n = 0 or 1

Default: &W1

The **&W** command stores current AT commands and S-register values in nonvolatile memory, so you won't lose your custom settings when you turn off the modem or reset it.

&W0 (or **&W**) stores all current AT command and S-register values in nonvolatile random access memory (NVRAM) and configures the modem so that it reads your custom settings in NVRAM when the modem is turned on or when it is reset with the **Z** command. (The **&F** reset command will continue to read the factory default settings in ROM unless you store the **&F9** command.)

&W1 erases your custom settings in NVRAM when the modem is turned off or reset, causing the modem to read the factory default settings in ROM when it is subsequently turned on or reset.

For further information on how the **&W** command interacts with the reset commands, see Table 3-2.

&Fn Load Default Configuration

n = 0, 8, or 9

Default: &F8

The MT2834MR6 modems store factory default AT command settings and S-register values in read-only memory (ROM); they store your custom AT command and S-register values in nonvolatile random access memory (NVRAM).

The **&F0** (or **&F**) command resets the modem to the factory default values stored in ROM or to your custom values stored in NVRAM, depending on whether you last stored an **&F8** or an **&F9** command.

When **&F8** is stored and an **&F** command is issued, the modem reads the factory default settings stored in ROM.

When **&F9** is stored and an **&F** command is issued, the **&W** setting determines whether the modem reads settings stored in NVRAM or ROM. If the modem is set to **&W0**, it reads your custom settings stored in NVRAM. If the modem is set to **&W1**, it erases your stored settings (including the **&F9** command) and reads the factory default settings stored in ROM. Many communications programs issue the **&F** command automatically—the **&F9** command allows you to select your own defaults.

Note that for either an **&F8** or an **&F9** command to be effective after a reset it must be stored using the **&W0** command.

Table 3-2 summarizes how the **&F** and **Z** reset commands interact with the **&W** command; note that the **&F** reset command operates differently from the **Z** reset command:

Table 3-2. Where the Modem Reads Configuration Parameters

Previous Command	AT&F	Power-On and ATZ
AT&W1 (default)	ROM	ROM
AT&W0	ROM	NVRAM
AT&F8&W0	ROM	NVRAM
AT&F9&W0	NVRAM	NVRAM

Z**Reset Modem**

The **Z** command resets the modem to its default configuration and clears the command buffer. The result is the same as turning the modem off and on. When you type **ATZ**, the state of the **&W** command determines where the default values originate. **&W0** defaults come from the customized configuration in NVRAM, and **&W1** defaults come from the factory default configuration in ROM. Because **Z** clears the command buffer, it must be the last command in a command string; normally it is issued by itself: **ATZ**.

Note that the **Z** reset command operates differently from the **&F** reset command. See Table 3-2.

3.6 Modem Response (Result Code) Commands

The MT2834MR6's modems can give responses to commands. The most common one is OK, but the modems also can alert you or your software to dial tones, busy signals, connection speeds, and whether the connection is made with error correction or compression enabled. These responses are called result codes, and they can be terse or verbose, Multi-Tech or standard, basic or extended.

- En** **Echo Command Mode Characters**
n = 0 or 1
Default: E1
 Normally, when you type commands on the keyboard, the modem echoes the characters back to the computer or terminal, which displays them on the monitor. Use the **E** command to turn this feature off and on.
E0 disables the echo.
E1 enables the echo.
- Qn** **Result Codes Enable/Disable**
n = 0, 1, or 2
Default: Q0
 You can use the **Q** command to enable or disable result codes for applications such as computer-controlled autodialing. You can also use it to disable responses and echo in answer mode while leaving originate mode still intelligent; this is called the no response answer mode of operation.
Q0 (or **Q**) enables result codes.
Q1 disables result codes for applications such as computer-controlled auto-dialing.
Q2 enables the no response answer mode, which leaves originate mode intelligent while turning off answer mode responses and echo.
- &Qn** **Result Codes (Multi-Tech or Standard AT)**
n = 0 or 1
Default: &Q0
 The MT2834MR6 gives you a choice between Multi-Tech result codes and standard AT command set responses. Multi-Tech result codes give you more information, but some datacomm programs may not be able to use them, in which case, select the standard result codes.
&Q0 selects Multi-Tech responses with RELIABLE, LAPM, and COMPRESSED modifiers. With **&Q0**, the verbose result code for 14,400 bps is CONNECT 14400 LAPM COMPRESSED.
&Q1 selects AT responses with no RELIABLE, LAPM, or COMPRESSED modifiers. With **&Q1**, the verbose result code for 14,400 bps is CONNECT 14400.

- Vn** **Result Codes (Verbose/Terse)**
n = 0 or 1
Default: V1
 The **V** command controls whether the modem's result codes display as verbal ("verbose") or digital ("terse") messages. For example, if no carrier signal is detected after dialing, the result can be displayed either as NO CARRIER, or as the digit 3.
V0 (or **V**) displays the modem's result codes as digits.
V1 displays result codes as words.
- Xn** **Result Codes and Call Progress Selection**
n = 0–4
Default: X0
 The **X** command selects which result codes the modem provides in command mode and whether the modem uses "smart dialing" or "blind dialing". When it smart dials, the modem listens for dial tones and busy signals and responds to them. When it blind dials, the modem ignores the signals and relies on timing instead.
X0 causes the modem to blind dial. Instead of looking for a dial tone, it pauses for the time set in register **S6** and then dials regardless. Once a connection has been made, it sends the Bell 103 basic code CONNECT to the terminal. It ignores any busy signals.
X1 causes the modem to blind dial, but in addition to the basic CONNECT code it provides extended codes consisting of the word CONNECT and the speed of the connection: CONNECT 2400, CONNECT 4800, CONNECT 9600, CONNECT 14400, CONNECT 19200, CONNECT 28800, and so forth. In this mode, the modem does not recognize or respond to dial tones or busy signals.
X2 causes the modem to wait for a dial tone before dialing. If it does not detect a dial tone within the time set by **S6**, the modem sends a NO DIALTONE result code to the terminal. In this mode, the modem provides extended result codes, but does not respond to busy signals.
X3 causes the modem to blind dial, but also it looks for a busy signal, and if it detects one, it sends a BUSY result code to the terminal. In this mode, the modem provides extended result codes, but it does not respond to dial tones.
X4 causes the modem to look for a dial tone and a busy signal, and respond with NO DIALTONE or BUSY, as appropriate. It also provides extended result codes. It is the most useful setting for most datacomm programs.
- &An** **Answerback**
n = 0 or 1
Default: &A0
 The **&A** command controls the MT2834MR6's answerback feature. Answerbacks are used in some online realty applications and elsewhere as a security measure. The **&A** command enables a modem to return a message to an identification request from another computer. The default identification is MESSAGE NOT PROGRAMMED.
&A0 disables the answerback feature.
&A1 enables the modem to return a message to an inquiry.

3.7 Online Connection Commands

The following commands control the conditions of the online connection.

- #An** **Auto Speed Detection**
n = 0–3
Default: #A0
- An MT2834MR6 modem can operate as a 33,600 bps, 28,800 bps, 19,200 bps, 14,400 bps, 9600 bps, 4800 bps, 2400 bps, or 300 bps modem. Use the **#A** command to select the speed that the modem uses for initial handshaking and subsequent speed selection. The **#A** command does not control the originating bps rate of the modem (that is done by the modem baud rate command **\$MB**), but only the answer mode starting speed.
- #A0** causes the modem to start at maximum speed, with fallback to 31,200 to 28,800 to 26,400 to 24,000 to 21,600 to 19,200 to 16,800 to 14,400 to 12,000 to 9600 to 4800 to 2400 to 1200 to 300 bps.
- #A1** causes the modem to operate at maximum speed only.
- #A2** causes the modem to start at maximum speed, with decremental fallback to 4800 bps.
- #A3** causes the modem to start at 2400 bps in V.22bis mode, with fallback to 1200 to 300 bps.
- Bn** **Answer Tone**
n = 0 or 1
Default: B0
- The **B** command selects the frequency the modem uses for its answer tone. (The answer tone is the tone a modem receiving a call transmits to the modem that called it, thus initiating the handshake between the two modems.) At higher speeds (2400 to 33,600 bps) there is no conflict, because all protocols use the Bell frequency of 2225 Hz. However, the ITU-T specification for V.22 has an answer tone frequency of 2100 Hz. This command is available only in International models.
- B0** enables ITU-T frequencies including V.21 (300 bps) and V.23 (1200/75 bps).
- B1** enables Bell frequencies including Bell 103 (300 bps).
- %DCn** **AT Command Control**
n = 0 or 1
Default: %DC0
- The **%DC** command allows you to disable the modem's ability to respond to AT commands. It can be used with autoanswer applications in which no call origination is required, with some UNIX applications, and with other applications that require you to disable the modem's command mode.
- %DC0** enables command mode.
- %DC1** disables command mode.

*Note: If you save **%DC1** as part of your default configuration, you can re-enable command mode by typing **AT%DC0** and pressing ENTER in the first ten seconds after you power up the modem.*

&CDn Cleardown at Disconnect**n = 0 or 1****Default: &CD0**

In the V.32, V.32bis, and V.34 protocols, a cleardown is sent by one of the modems to signal the other modem that it is going to hang up. A cleardown is rate renegotiation in which the modem that is hanging up tells the other modem that it has no speeds that it can connect at. It is designed to help the remote modem detect a hangup. However, it does take a second or two to send the cleardown. If you find this delay unacceptable, you can disable cleardown by using the **&CD** command.

&CD0 enables cleardown at disconnect.

&CD1 disables cleardown at disconnect.

>DTn DTMF Detection**n = 0 or 1****Default: >DT0**

Normally, when it goes off-hook, a fax modem ignores tones from the other end of the connection unless they are fax or modem handshake tones, in which case it responds in kind. The **>DT1** command causes the modem to report DTMF (touch-tone) tones and fax calling tones to software for further processing. A typical use would be for a program that routes calls to specific communications applications depending on the type of call or upon a DTMF tone added to a dialing string.

>DT0 disables DTMF detection.

>DT1 enables DTMF detection when the modem goes off-hook.

#Fn Fallback Modes**n = 0, 1, or 2****Default: #F2**

The **#F** command controls whether the modem will fall back to a lower speed because of an unacceptable error rate. If line conditions deteriorate, the modem has the ability to fall back from its original speed to the next lower speed when operating in V.34, V.32terbo, V.32bis, or V.32 mode. If the error rate becomes too great, the modem performs a retrain at the next lower speed. If, after the retrain, the error rate is still too high, the modem performs a retrain at the next lower speed, down to 4800 bps.

If the modem returns online at the original speed after the first retrain, the modem starts a counter and a timer. If three retrains occur within a two-minute period, the modem falls back to 4800 bps.

The fallback and fall-forward speeds for the modem are 33.6K, 31.2K, 28.8K, 26.4K, 24.0K, 21.6K, 19.2K, 16.8K, 14.4K, 12K, 9.6K, and 4.8K bps.

#F0 (or **#F**) disables fallback when online.

#F1 lets the modem fall back from the starting speed to a low speed of 4800 bps in 2400 bps decrements.

#F2 lets the modem fall back when line conditions deteriorate, but also lets it fall forward in 2400 bps increments if line conditions improve.

-
- &Gn** **Guard Tones**
n = 0, 1, or 2
Default: &G0 (models outside U.K.)
 &G2 (U.K. models only)
- The **&G** command is used to control the presence or absence of guard tones from the transmitter when in answer mode at either 1200 or 2400 bps. Guard tones are used in Europe and other areas to allow the modem to function in the telephone systems. Guard tones are not used in the United States. U.K. models are locked at **&G2** (1800 Hz guard tone).
- &G0** disables ITU-T guard tones.
&G1 enables ITU-T 550 Hz guard tone.
&G2 enables ITU-T 1800 Hz guard tone.
- *Hn** **Busy-Out After Disconnect**
n = 0 or 1
Default: *H0
- The ***H1** command causes the MT2834MR6 to remain out of service and return a busy signal until configuration from the MultiModemManager dedicated management console has finished. If no configuration option is set on the dedicated management console, the MT2834MR remains out of service for ten seconds after disconnect. Register **S94** controls the length of the out-of-service, or busy-out, time (see Chapter 4).
- *H0** disables busy-out after disconnect.
***H1** enables busy-out after disconnect.
- &Pn** **Set Pulse-Dial Ratios**
n = 0 or 1
Default: &P0 (Models outside U.K.)
 &P1 (U.K. models only)
- The **&P** command sets the time ratios between the open (break) and closed (make) states of dialing pulses. U.K. models are locked to **&P1** (67:33 ratio). See Appendix B for more dial pulse information.
- &P0** sets a pulse dial ratio of 60 ms break to 40 ms make.
&P1 sets a pulse dial ratio of 67 ms break to 33 ms make.
- &RDn** **Square Wave Ring Detect**
n = 0 or 1
Default: &RD0 (U.K. and International models)
 &RD1 (North American models)
- The ringback sound that you hear when you dial a number is generated at the local telephone office or PBX. Normally, it is a sine wave analog tone. However, some PBXs generate square wave rings that can go undetected by normal ring detection circuits, resulting in a failure to make a connection. To enable your modem to detect square wave rings, use the **&RD1** command.
- &RD0** enables sine wave ring detection only.
&RD1 enables sine wave and square wave ring detection.

\$Tn	Calling Tone n = 0 or 1 Default: \$T1 The \$T command enables or disables the modem's calling tone, which is required by some European countries to identify the caller as a modem. \$T0 enables the calling tone. \$T1 disables the calling tone.
#Tn	Trellis-Coded Modulation n = 0 or 1 Default: #T1 The #T command enables or disables trellis-coded modulation (TCM) on the modem. There is usually no need to disable TCM, except for an unusual line condition called impulse noise. #T0 disables TCM. #T1 enables TCM.
Yn	Long Space Disconnect n = 0 or 1 Default: Y0 When two modems are connected in reliable mode, a link disconnect request packet is sent to request a disconnect. In non-error correction mode, there is no "polite" way to request a disconnect. As a result, some "garbage" may be received when a hang-up command is issued. Y0 disables the modem's use of the break signal. Y1 enables the modem's use of the break signal, which shuts off the modem's receiver and disconnects (both modems must have Y1 enabled).

3.8 V.34 Commands

The following commands apply only in V.34 mode.

%Fn	Echo Canceler Frequency Offset Compensation n = 0 or 1 Default: %F0 The %F command enables and disables echo canceler frequency offset compensation which, when enabled, can decrease modem performance. %F0 disables echo canceler frequency offset compensation. %F1 enables echo canceler frequency offset compensation.
&RA n	Asymmetric Bit Rate n = 0 or 1 Default: &RA0 The &RA command enables or disables asymmetric bit rate operation in V.34 mode. The asymmetric bit rate feature lets the modem transmit at one rate while receiving at a different rate. &RA0 enables asymmetric bit rate operation. &RA1 disables asymmetric bit rate operation.
#Vn	V.32terbo Handshake n = 0 or 1 Default: #V1 Some V.32/V.32bis modems have problems handshaking when the MT2834MR6 includes V.32terbo mode (19,200 bps) in its handshake. The bits that are used in the rate sequence for V.32terbo can cause handshake failure. Use the #V command to include or exclude V.32terbo mode from the handshake. #V0 includes V.32terbo mode in the handshake. #V1 excludes V.32terbo mode from the handshake.

3.9 RS-232 Interface Commands

These commands define how an MT2834MR6 modem will use and respond to standard RS-232 signals.

&Cn Carrier Detect Control

n = 0, 1, 2, or 4

Default: &C1

The **&C** command lets you control the Carrier Detect (CD) signal on the RS-232/V.24 interface. Normally, CD goes high when the modem detects a carrier on the communications link, and drops when it loses the carrier. By using **&C**, however, you can force the signal to stay high, or to drop momentarily when the remote modem disconnects. (This option is useful with some CBX phone systems and mainframe front ends, which require CD to act in this manner). You can also force the modem to reset when the CD signal drops.

&C0 forces CD high.

&C1 allows CD to act normally—to go high when the modem detects a carrier, and to drop when it loses the carrier.

&C2 causes CD to drop for one second on disconnect, and then go high again. (If you want to set the drop time to something other than one second, change register **S24**).

&C4 resets the modem when CD drops.

&Dn Data Terminal Ready Control

n = 0, 1, 2, or 3

Default: &D2

The Data Terminal Ready (DTR) signal on pin 20 of the RS-232/V.24 interface must be high, or “on,” in order for the modem to operate. A high DTR signal tells the modem that the computer it is connected to is ready to communicate through the modem.

The DTR signal can also be used to cause the modem to reset to its default parameters, as if you had given the modem an ATZ command.

&D0 (or **&D**) causes the modem to ignore DTR.

&D1 causes the modem to hang up when DTR drops. While DTR is low, the modem accepts commands, but will not dial or auto-answer until DTR goes high again.

&D2 acts the same as **&D1**.

&D3 causes the modem to reset when DTR drops. It will also hang up if it is online.

&Rn Clear to Send Control

n = 0, 1, or 2

Default: &R1

The **&R** command lets you control the state of the Clear to Send (CTS) signal on pin 5 of the RS-232/V.24 interface. Normally, CTS follows RTS when the modem is online. You have three choices. You can force the signal high, allow it to act normally, or set it to stay high until the modem disconnects, go low momentarily, and then go high again. The last option is useful with CBX phone systems and mainframe front ends that require CTS to act in this manner.

&R0 lets CTS act normally, that is, to follow RTS.

&R1 forces CTS high. When the modem goes online, CTS still provides flow control.

&R2 lets CTS drop on disconnect for the time set by register **S24**, then go high again.

-
- &Sn** **Data Set Ready Control**
n = 0, 1, or 2
Default: &S1
- Use the **&S** command to control the state of the Data Set Ready (DSR) signal on the RS-232/V.24 interface. Normally, DSR follows CD. You can force the signal high; allow it to act normally; or set it to stay high until the modem disconnects, go low momentarily, and then go high again.
- &S0** forces DSR high.
- &S1** allows DSR to act normally, that is, to follow CD.
- &S2** sets up DSR so that it drops for one second on disconnect and then comes up again. (If you want to set the drop time to something other than one second, change register **S24**.)
- &RFn** **CTS/RTS Interaction Control**
n = 0 or 1
Default: &RF1
- In normal operation, Clear to Send (CTS) follows Request to Send (RTS) when the modem is online. In other words, if RTS goes off, CTS goes off. In some applications, however, it is necessary for CTS to operate independently of RTS.
- &RF0** enables CTS to follow RTS.
- &RF1** enables CTS to operate independently of the state of RTS. See the **&R** command for control of CTS.
- &SFn** **DSR/CD Interaction Control**
n = 0 or 1
Default: &SF0
- Normally, the Data Set Ready (DSR) signal follows the Carrier Detect (CD) signal. In other words, if CD goes high, DSR goes high. In some applications, however, it may be necessary for DSR to operate independently of CD.
- &SF0** enables DSR to follow CD.
- &SF1** enables DSR to operate independently of CD. For control of DSR, see the **&S** command.

3.10 Error Correction and Data Compression Commands

You can configure a modem to any of three different V.42 modes of operation (each mode can be with or without compression). They are the non-error correction, autoreliable, and reliable modes. You can also turn data compression on or off.

&En Error Correction Modes

n = 0, 1, or 2

Default: &E1

Select the modem's error correction mode using the **&E0**, **&E1**, or **&E2** command.

&E0 disables the modem's V.42 error correction capabilities, and the modem functions as a non-error correction modem.

&E1 enables autoreliable mode. During the handshaking procedures at the start of the online connection, the modem queries whether the other modem is using V.42 error correction. If the modem determines that the other modem is using V.42, it switches itself into reliable (V.42) mode and enables error correction. If it determines that the other modem is not using V.42, the modem remains in non-error correction mode.

&E2 enables reliable mode, in which the modem uses its V.42 error correction capabilities for all transmissions. In reliable mode, the modem must be connected to a modem with a V.42 protocol (MNP or LAP-M).

The V.42 standard includes MNP Class 3 and 4 and LAP-M error correction methods. The V.42 mode select command (**#L**) selects which type of error correction the modem uses for transmissions.

&En Data Compression

n = 14 or 15

Default: &E15

Data compression is normally enabled, providing **&E1** (autoreliable mode) or **&E2** (reliable mode) has also been selected. However, you may wish to turn it off in certain circumstances.

&E14 disables data compression.

&E15 enables data compression.

#Ln V.42 Error Correction Modes

n = 0-3

Default: #L0

The **#L** command selects the V.42 error correction method (MNP or LAP-M) the modem uses when originating a call. In answer mode, the modem ignores the **#L** command and accepts whichever V.42 mode, MNP or LAP-M, the originating modem offers.

#L0 causes the modem to negotiate the V.42 error correction method with the answering modem, and to begin negotiation with LAP-M. If both modems have LAP-M capability, the modems will use LAP-M mode. If one or both modems do not have LAP-M capability and both have MNP, the modems will use MNP.

#L1 enables MNP error correction and disables LAP-M.

#L2 enables LAP-M error correction and disables MNP.

#L3 enables LAP-M error correction and disables MNP, but skips the V.42 detection phase used by the other commands. Both modems must be set with **#L3**.

\$En	<p>V.42 Error Correction at 300 bps n = 0 or 1 Default: \$E0</p> <p>At 300 bps, error correction is not normally used. \$E0 disables 300 bps/V.42 error correction altogether. \$E1 enables the modem to function at 300 bps in non-error correction (&E0), autoreliable (&E1), or reliable (&E2) mode.</p>
\$An	<p>Autoreliable Buffering n = 0 or 1 Default: \$A0</p> <p>In autoreliable mode, the modem has four seconds to establish a reliable connection, after which the modem drops to non-error correction mode. Any data received during this period will normally be discarded. The \$A command causes the modem to buffer (store) data that is received during the autoreliable time-out period. This data is then output by the modem after the CONNECT message. \$A0 discards the data received during the autoreliable time-out period. \$A1 buffers data received during the autoreliable time-out period.</p>
\$Fn	<p>Autoreliable Fallback Character Enable/Disable n = 0 or 1 Default: \$F0</p> <p>In autoreliable mode, the modem has four seconds to establish a reliable connection. If a single carriage return is received from the remote modem during this period, the autoreliable modem assumes that the remote modem is not in reliable mode, and drops to non-error correction mode. The carriage return is the only character that causes the modem to drop to non-error correction mode. Any other data is either buffered or discarded. Use the \$F command to enable this feature. You can use the autoreliable fallback character (\$F) and autoreliable buffering (\$A) commands together to cause the modem to buffer all data received up until the carriage return, and then drop to non-error correction mode. All data received is then output following the CONNECT message. \$F0 causes the modem not to fall back to non-error correction connect if a carriage return is received. \$F1 causes the modem to fall back to non-error correction connect if a carriage return is received.</p>
\$Rn	<p>Retransmit Count n = 0 or 1 Default: \$R0</p> <p>If errors are received during a reliable connection, the modem re-sends the block of data that contained an error. If another error occurs, it re-sends the block again. The modem counts the number of times that a data block is re-sent. \$R0 causes the modem to disconnect if the same block of data is re-sent 12 times without being received properly, on the assumption that the line is unsuitable for transmission. \$R1 causes the modem to disable the retransmit counter, so that the modem keeps trying to send data and will not abort, no matter how many times the same block is resent. Type AT\$R0 to disconnect the modem if all attempts to re-send the block fail.</p>

3.11 Speed Conversion Commands

Speed conversion allows the MT2834MR6 to communicate at a fixed speed through the serial port while communicating at an independent speed over the online communications link. Speed conversion is necessary for data compression, since data compression requires data to be sent from the computer to the modem at a rate up to four times faster than the modem's transmission speed.

Speed conversion is also useful for an autoanswer modem connected to a computer that does not have autobaud capability, since the computer must be set at a fixed baud rate regardless of the speed at which the modem communicates over the phone line.

\$BA_n

Baud Adjust

n = 0 or 1

Default: \$BA0

Turning baud adjust off turns speed conversion on; turning baud adjust on turns speed conversion off.

When baud adjust is on, the modem matches its RS-232 serial port speed to any changes in the computer's serial port speed in originate mode, or to the speed of the originating modem when it's in answer mode. With baud adjust on, the speed at which the modem communicates over the phone line is always the same as the speed at which it communicates via its RS-232 serial port.

When speed conversion is on, the modem does not adjust its speed at the serial port to match its transmission speed. Serial port speed and transmission speed can therefore be set independently. Speed conversion is necessary for a high speed modem that is connected to a limited speed serial port.

\$BA0 turns baud adjust off and speed conversion on.

\$BA1 turns baud adjust on and speed conversion off.

\$MB_n

Modem Baud Rate

n = speed in bits per second

Default: \$MB33600

The **\$MB** command sets a modem's initial transmission speed for originate mode. In V.32 mode (9600 bps), it also sets the transmission speed for answer mode. With speed conversion on, this transmission speed can be different from the serial port speed.

When the modem answers a call from another modem, it automatically switches its transmission speed to match the calling modem. However, if the MT2834MR6 originates a call to another modem that is unable to connect at the same transmission speed, the MT2834MR6 automatically drops to a lower speed in an attempt to match the speed of the other modem.

Speed conversion must be on for this command to work. If baud adjust is on (**\$BA1**), speed conversion is off and a modem baud rate command will be ignored. The **S48** register also can affect maximum transmission speed. See Chapter 4.

\$MB75	ITU-T V.23 mode	\$MB300	300 bps
\$MB1200	1200 bps	\$MB2400	2400 bps
\$MB4800	4800 bps	\$MB7200	7200 bps
\$MB9600	9600 bps	\$MB12000	12,000 bps
\$MB14400	14,400 bps	\$MB16800	16,800 bps
\$MB19200	19,200 bps	\$MB28800	28,800 bps
\$MB33600	33,600 bps (default)		

\$SBn**Serial Port Baud Rate****n = speed****Default: \$SB57600**

The **\$SB** command sets the speed of the MT2834MR6's serial port in both originate and answer modes. Speed conversion allows you to set this serial port baud rate at a fixed speed of up to 115,200 bps, regardless of the modem's transmission speed setting.

For this command to work, the modem's baud adjust feature must first be turned off with the **\$BA0** command. When baud adjust is on, as soon as the modem receives its first AT command, it automatically adjusts its serial port baud rate to match the speed of the computer or terminal to which it is connected. However, in applications such as automatic answer, the modem may not receive AT commands. In this case it is helpful to be able to preset the serial port baud rate with the **\$SB** command.

In addition to setting the modem's serial port speed, this command sets the speed at which the modem issues command mode responses (result codes).

The MT2834MR6 accepts AT commands at any speed, regardless of the speed preset by the **\$SB** command. If the modem receives a command at a speed different from the preset speed, the modem switches its serial port baud rate to match the new command speed, even though the baud rate value stored by the **\$SB** command remains the same. This provides you with a convenient way to switch the serial port speed while still making it easy to automatically return to the original speed the next time the modem is powered up or reset.

\$SB300	300 bps	\$SB1200	1200 bps
\$SB2400	2400 bps	\$SB4800	4800 bps
\$SB9600	9600 bps	\$SB19200	19,200 bps
\$SB38400	38,400 bps	\$SB57600	57,600 bps
\$SB115200	115,200 bps (default)		

3.12 Immediate Action Commands

Use these commands to get information about AT commands and the current settings of the modem. For additional immediate action commands, see “Line Probe Commands.”

A/ **Repeat Last Command**
Default: None

Type **A/** to repeat the previous command. Do not precede this command with **AT** or press ENTER to execute it.

In **Inquire Product Code**
n = 0, 1, or 2
Default: none

Some systems or software packages automatically check the identification of the modem by using the **I** command. Besides using it to check the modem ID, you can use the **I** command to check the version number of the modem's built-in software, known as firmware.

ATI0 or **ATI** requests the modem's ID number.

ATI1 requests the modem's firmware version number. You can use this command to identify your modem's firmware level when calling Technical Support.

ATI2 requests the product name, such as MT2834MR6.

ATI5 requests the digital signal processor version number.

L5, L7 **List Current Operating Parameters**
Default: none

The **L5** and **L7** commands cause your modem to list its current operating parameters. These lists are useful when you are changing communications software, or when you are changing modem default settings. All modem configuration parameters are listed.

ATL5 lists the modem's current operating parameters.

ATL7 lists additional modem parameters.

L6 **List Current S-Register Values**
Default: none

ATL6 lists the current values in the modem's S-registers. This information can be very useful if you wish to change S-register values.

L8 **List Online Diagnostics**
Default: none

The **L8** command displays the modem's online status. You can print this display and use it as a modem status report or as diagnostic information (such as when calling Technical Support).

To enter this command while online, type **+++ATL8<CR>**. Your modem's online status will be displayed, listing current operating conditions such as link type, line speed, serial speed, line quality, and reason for last disconnect.

If you type **+++ATL8** with the modem online, the current online status will be displayed. If you type **ATL8** with the modem in command mode, the most recent online status will be displayed. If you type **ATL8** immediately after modem power-up, the message NO INFORMATION AVAILABLE will be displayed.

&RN

Rate Renegotiation

Default: none

The **&RN** command forces the modem to perform a rate renegotiation while online. To issue it, you must first escape to command mode by issuing the **+++AT<CR>** command.

&RR

Retrain

Default: None

The **&RR** command forces the modem to perform an immediate retrain while online. To issue it, you must first escape to command mode by issuing the **+++AT<CR>** command.

3.12 Flow Control Commands

Flow control refers to the techniques used by data terminal equipment and the modem to pause and resume the flow of information between them. It prevents a device from accepting more data than it can handle. The modem implements flow control in both directions. When the modem halts the flow of data, it is called flow control, and when the computer halts the flow, it is called pacing.

&BSn Maximum Reliable Block Size

n = 0 or 1

Default: &BS1

When the modem is in reliable mode, use the **&BS** command to set the maximum size of a data block. MNP Class 3 sends a 64-character block, while Classes 4 and 5 normally send blocks of 256 characters or less. Reducing the block size for MNP 4 and 5 may improve overall throughput when phone lines are noisy; however, it also could slow data transfer if line quality is good.

&BS0 sets the maximum transmit block size to 64 characters.

&BS1 sets the maximum transmit block size to 256 characters.

\$EBn Asynchronous Word Length

n = 0 or 1

Default: \$EB0

The MT2834MR6 can operate with either a 10-bit format (one start bit, seven data bits, one parity bit, and one stop bit) or an 11-bit format (one start bit, eight data bits, one parity bit, and one stop bit) in both command and online modes.

\$EB0 enables a 10-bit format. It automatically detects parity when an AT command is issued.

\$EB1 enables an 11-bit format.

&E3 Flow Control Disable

The **&E3** command completely disables data flow control initiated by the modem.

&E4 Hardware Flow Control

Factory default. The **&E4** command enables the modem's use of the Clear to Send (CTS) signal on the RS-232/V.24 interface to regulate data flow. When CTS drops, data flow is suspended until the signal goes high again. This method of flow control works in conjunction with pacing (i.e., computer-initiated flow control), which uses the Request to Send (RTS) signal on the RS-232/V.24 interface. Hardware flow control cannot be enabled unless an active error correction protocol is selected.

- &E5** **XON/XOFF Flow Control**
XON/XOFF flow control is an in-band method of data flow regulation used by the modem or computer (i.e., by flow control or pacing). If you issue the **&E5** command to the modem, it will respond to XON/XOFF pacing, and use XON/XOFF characters as its own method of flow control to the computer.
In-band data regulation means that the XON and XOFF characters (^Q and ^S, respectively) are inserted into the stream of data rather than using separate control lines. When an XOFF character is detected, the data stream is suspended until an XON character is detected. The drawback to using this method of pacing is that some files may contain these characters. If such a file is transferred using a modem, the file transfer can be suspended indefinitely.
- &En** **XON/XOFF Pass-Through**
n = 6 or 7
Default: &E6
When XON/XOFF pacing is active, the local modem has two options regarding the XON and XOFF characters. It can respond to and discard the characters from the computer, or it can respond to the characters and pass them through the datacomm link to the remote modem, thereby pacing the remote modem as well.
&E6 causes the modem to respond to and discard the XON and XOFF characters.
&E7 causes the modem to respond to the characters and pass them through the data link to the receiving modem.
- &En** **Hewlett Packard ENQ/ACK Pacing**
n = 8 or 9
Default: &E8
If the MT2834MR6 is used with Hewlett Packard (or compatible) equipment, it can be configured to respond to ENQ/ACK pacing as a complement to any other form of active flow control or pacing. In that case, pacing from the Hewlett Packard equipment is processed according to the HP protocol.
&E8 causes the modem to ignore ENQ/ACK pacing.
&E9 causes the modem to respond to the ENQ (^E) and ACK (^F) characters.
- &En** **Non-Error Correction Mode Flow Control**
n = 10 or 11
Default: &E10
When two modems are connected in non-error correction mode, XON/XOFF flow control can be used as a complement to XON/ XOFF pacing.
&E10 disables non-error correction mode flow control.
&E11 enables non-error correction mode flow control.

&En Pacing (Computer-Initiated Flow Control)

n = 12 or 13

Default: &E13

Pacing is the means by which the DTE (data terminal equipment—your computer or terminal) regulates the stream of incoming data. It is only enabled when the modem has some form of flow control active, such as RTS/CTS or XON/XOFF. When pacing is enabled, the modem responds to the DTE's pacing signals. When pacing is disabled, the modem ignores any pacing signals from the DTE.

&E12 disables pacing.

&E13 enables pacing.

#Xn Number of XOFF Characters Sent

n = 0 or 1

Default: #X0

The **#X** command allows the modem to send either a single or multiple XOFF characters when the modem's buffer becomes full. When the buffer is full, the next character received causes an XOFF character to be sent. In default mode, only one character is sent until the buffer reaches the XON level; however, it is also possible to send one XOFF character for every character received after the buffer is full.

#X0 causes only a single XOFF character to be sent after the buffer is full.

#X1 causes one XOFF character to be sent for every character received after the buffer is full.

3.13 Escape Sequences

Escape sequences (escape codes) cause the modem to enter command mode from online mode without disconnecting the call. There are two local escape sequences used by the modem, **+++AT<CR>** and **<BREAK>AT<CR>**, and one remote escape sequence, **%%AT<CR>** (see "Remote Configuration").

+++AT<CR> In-Band Escape Sequence

When the modem is online with a remote modem, enter command mode (without disconnecting the call) by typing this escape code. The default escape code is three plus signs (+++) followed by the letters AT, up to 10 command characters and ENTER. The modem escapes to command mode, executes the command (if any), then remains in command mode.

<BREAK>AT<CR> Out-of-Band Escape Sequence

An alternate escape method uses a break signal as the escape code. The break signal is ten or more zero bits issued by data communications software. This allows the DTE to signal the modem without the modem interpreting data characters as modem control characters. The break signal is followed by the letters AT, up to 60 command characters, and ENTER. The modem executes the command and immediately returns to online mode, unless the command is to hang up and/or reset the modem (an **H** or **Z** command). In the latter case, the modem escapes to command mode after executing the **H** or **Z** command.

%En Escape Sequence Options

n = 0–5

Defaults: %E1 and %E4

Optional settings cause the modem to respond to the **<BREAK>** method, or respond to either the **+++** or the **<BREAK>** methods, or for the modem to ignore both methods and not escape. The **%E** command is used to select these options as follows:

%E0	Modem doesn't escape
%E1	+++ AT<CR> escape method (factory default).
%E2	<BREAK> escape method.
%E3	Either +++ or <BREAK> escape methods.
%E4	Disables OK response to +++ (factory default).
%E5	Enables OK response to +++ .
%E1 %E5	Enables +++ method and OK responses to +++ .
%E3 %E5	Enables +++ or <BREAK> method and OK responses to +++ .

A Force Answer Mode

Use the **A** command to force the modem into answer mode. Type **ATA** when in command mode to immediately bring the modem off-hook, out of command mode and into online answer mode, transmitting the carrier signal over the phone line. If no responding carrier tone is received within forty-five seconds (or by the time you have specified in register **S7**), the modem stops transmitting and hangs up, returning to command mode.

O Go Back Online

Use the **O** command to bring the modem out of command mode and back into online mode. The **O** command reverses the result of entering the escape code. The **O** command brings the modem into whichever online mode (originate or answer) that it was in prior to entering command mode.

3.14 Remote Configuration Commands

When you are online with another Multi-Tech modem, you can issue AT commands to it by sending a remote configuration escape sequence. The remote modem responds by displaying a menu and asking for a setup password. The MT2834MR6 has two default passwords. Please note that if you change them, you cannot retrieve them by resetting the modem by using **AT&W1**; you must know the new passwords to make any further changes. For further information on remote configuration, see Appendix I, "Remote Configuration."

%%AT<CR> Remote Configuration Escape Sequence

Enter the remote configuration escape sequence to initiate remote configuration when you are online with another Multi-Tech modem. The default escape sequence used by the MT2834MR6 is three percent signs (%%%) followed by the letters AT and ENTER. The remote configuration escape character, which is stored in register **S13**, can be changed either locally or remotely for greater security.

#lxxxxx Change Login Password

xxxxxx = password
Default: #IMULTI-TECH

Use the **#l** command to enter or change the remote configuration login password.

AT#lxxxxx enters the current remote configuration login password, where xxxxxx represents the password. If the password is wrong, the remote modem responds with ERROR; if it is correct, the remote modem responds with OK, and you can proceed with the **#S** command.

AT#l=xxxxxx stores a new remote configuration login password, where xxxxxx represents the password. The password is case sensitive, and can be any combination of upper and lower case keyboard characters. It must be six to ten characters in length.

#Syyyyyy Change Setup Password

yyyyyy = password
Default: #SMODEMSETUP

Use the **#S** command to enter or change the remote configuration setup password. Before you can use it, you must enter the login password using the **#l** command.

AT#Syyyyyy enters the current remote configuration password, where yyyyyy represents the password. If the password is wrong, the remote modem responds with ERROR; if it is correct, the remote modem responds with OK, and you can proceed with the next command.

AT#S=yyyyyy stores a new remote configuration setup password, where yyyyyy represents the password. The password is case sensitive, and can be any combination of upper and lower case keyboard characters. It must be six to ten characters long.

3.15 Line Probe Commands

Before V.34 negotiation, the local and remote modems use modulated calling and answering tones to exchange capability information. If V.34 mode communication is successful, probing signals are exchanged to identify impairments in the telephone channel. Using the results of these line probes, communication parameters are set, including carrier frequencies and data rates used for transmission. The following commands apply to modems only in V.34 mode.

- %DPn** **Read Line Probe Data**
n = 0 or 1
Default: %DP0
- The modem does not normally store data acquired during line probe. To examine the line probe data using the **L9**, **L10**, or **L11** commands, set the **%DP1** command to read and store line probe data.
- %DP0** disables reading of line probe information during the handshake.
%DP1 enables reading of line probe information during the handshake.
- %DFn** **Format Line Probe Data**
n = 0 or 1
Default: %DF0
- Use this command to select line probe data displayed as a graph with the Y axis showing signal strength in dBm, or as a table with dBm values shown numerically. The graph format shows data in 150 Hz increments from 150 Hz to 3750 Hz. The table format shows data in 75 Hz increments from 150 Hz to 3750 Hz.
- %DF0** displays line probe data in graph format.
%DF1 displays line probe data in table format.
- &RP** **Immediate Line Probe**
Default: none
- This command initiates a retrain that makes the processor read line probe information for display using the **L9**, **L10**, and **L11** commands. Before issuing this command, escape to command mode while remaining online. To combine both actions, use the following command string: **+++AT&RP<CR>**.
- The modem will not read and store the line probe information from this retrain unless a **%DP1** command is first issued.
- Ln** **Display Line Probe Data**
n = 9–11
Default: none
- These immediate action commands cause the modem to display line probe information when it is in V.34 mode. The line probe information must first be read and stored by the modem (see "Read Line Probe Data"). Data format is controlled by the Format Line Probe Data command, **%DF**.
- The display commands are valid only in online mode. To use them online, you must first escape to command mode with **+++AT<CR>**. To return online, enter **ATO**.
- ATL9** displays signal strength information.
ATL10 displays the signal to noise ratio (SNR).
ATL11 displays noise information.

3.16 Diagnostic Commands

The MT2834MR6 has two diagnostic commands and four diagnostic modes. The power-on self-test is activated every time power is applied. The **U** command selects a loopback test, while the **&T** command enables a modem to respond to a loopback test from another modem. See Chapter 6, "Testing the MT2834MR6," for a fuller discussion. Refer to the **L8** command to see how to list the diagnostic online status.

&Tn Respond to Remote Digital Loopback Signal

n = 4 or 5

Default: &T5

The MT2834MR6 has several self-test features, discussed in Chapter 6. The **&T** command enables or disables the modem's ability to recognize the remote digital loopback (RDL) test signal. (See Chapter 6 for remote digital loopback test procedures.)

AT&T4 lets the modem respond to an RDL signal, and places it in digital loopback.

AT&T5 causes the modem to ignore the RDL signal.

Un Loopback Test Modes

n = 0–3

Default: None

Loopback tests send data through the modem in such a way that it loops back to the terminal where it was entered, testing all the circuits along the way. The **U** command selects from several loopback tests. See Chapter 6, "Testing Your Modem," for more information.

ATU0 places the modem in originate mode for the local analog loopback test.

ATU1 places the modem in answer mode for the local analog loopback test.

ATU2 performs the remote digital loopback test.

ATU3 performs the local digital loopback test.

Chapter 4 - S-Registers

4.1 Introduction

This chapter describes the MT2834MR6's *S-registers*, which are small regions of memory where modem configuration information is stored. Whereas AT commands tell a modem *what* to do, S-registers tell the modem *how* to do it. Each S-register has a name that consists of the letter *S* and a number (**S0**, **S1**, **S2**, etc.), hence the term *S-register*. Use the **Sr?** command to read the value stored in an S-register, and the **Sr=n** command to change it.

4.2 S-Registers

S0 **Number of Rings Until Modem Answers**

Unit: 1 ring

Range: 0–255

Default: 1

S0 defines the number of rings the modem waits before answering an incoming call. The default value is one ring, which causes the modem to answer the call immediately after the first ring. The maximum number of rings that can be configured is 255. Setting the value to zero disables autoanswer.

S1 **Ring Count**

Unit: 1 ring

Range: 0–255

Default: 0

S1 counts the number of rings that have occurred. It is a “read” type of register and is seldom, if ever, used in typical operation. Each time an incoming ring signal is detected, **S1** increases its value by one, up to a maximum of 255. If you set **S1** to a value other than its default value of zero, or if the value is increasing with rings, this new value remains stored in **S1** for eight seconds after the last ring is counted, after which the value reverts back to zero.

S2 **Escape Code Character**

Unit: Decimal

Range: 0–127

Default: 43 (+)

S2 defines the escape code character by its decimal ASCII code. The default character is the plus (+) sign (decimal 43). **S2** may be set for any ASCII character. Setting an **S2** value greater than 127 results in no escape character, and therefore no means of entering command mode from online mode without breaking the online connection, unless you use the BREAK method. See Appendix H, “Multi-Tech Escape Methods.”

Note: If you change the S2 value, you must make corresponding changes in your data communications software.

- S3** **Return Character**
Unit: Decimal
Range: 0–127
Default: 13 (^M)
- S3** defines the carriage return character by its decimal ASCII code. The default setting is the ^M character (decimal 13), which is the code for the ENTER key on most keyboards. **S3** may be set for any ASCII character.

Note: If you change the S3 value, you must make corresponding changes in your data communications software.

- S4** **Line Feed Character**
Unit: Decimal
Range: 0–127
Default: 10 (^J)
- S4** defines the line feed character by its decimal ASCII code. The default setting is ^J (decimal 10), which is the code for the line feed key on most keyboards that have such a key. **S4** may be set for any ASCII character.

- S5** **Backspace Character**
Unit: Decimal
Range: 0–127
Default: 8 (^H)
- S5** defines the backspace character by its decimal ASCII code. The default setting is the ^H character (decimal 8), which is the code for the BACKSPACE key on most keyboards. **S5** may be set for any ASCII character.

Note: If you change the S5 value, you must make corresponding changes in your data communications software.

- S6** **Wait Time for Dial Tone**
Unit: 1 second
Range: 2–255 (North America)
 4–255 (International)
 4–7 (U.K.)
Default: 2 (North America)
 4 (International and U.K.)
- S6** defines the length of time the modem waits after the ENTER key is pressed before executing a dial command. The default setting is two seconds for North America, four seconds elsewhere.

- S7** **Time for Carrier (Abort Timer)**
Unit: 1 second
Range: 1–255 (U.S.A.)
 1–45 (Canada and International)
 1–55 (U.K.)
Default: 45 (North America and International)
 55 (U.K.)
- S7** determines the abort timer delay time, which is the amount of time your modem will wait for a carrier signal before it disconnects. The default value is 45 seconds, except the U.K. model, for which it is 55 seconds. This means that, after dialing, the modem waits for a carrier signal for up to 45 or 55 seconds and, if none is detected, aborts the call. The maximum **S7** value is 255 seconds for the U.S.A. model, 45 seconds for Canadian and International models, and 55 seconds for the U.K. model.
- S8** **Pause Time for Comma**
Unit: 1 second
Range: 0–255 (North America)
 4–255 (International)
 4–7 (U.K.)
Default: 2 (North America)
 4 (International and U.K.)
- S8** determines the length of the pause caused by a comma in a dialing command. The default setting is two seconds for the North American model, and four seconds for the International and U.K. models. **S8** may be set for up to 255 seconds. **S8** also defines the length of time the modem waits before retrying a call after it detects a busy signal. Some computer systems need more than two seconds to reset, in which case you should increase the value of **S8**.
- S9** **Carrier Detect Response Time**
Unit: 100 ms
Range: 1–255
Default: 6
- S9** determines the time delay between when the modem first detects a valid incoming carrier signal and when the modem turns on its Carrier Detect circuit. The default setting is 600 milliseconds (six units of 100 ms each). **S9** may be set for up to 25.5 seconds.
- S10** **Carrier Loss Disconnect Delay Time**
Unit: 100 ms
Range: 1–254, 255
Default: 7
- S10** defines the length of time after a loss of carrier signal before the modem disconnects. The default setting is 700 ms (seven units of 100 ms each). Maximum delay is 25.4 seconds (decimal 254). Setting the **S10** value to 255 causes the modem not to disconnect with loss of carrier.

- S11** **Tone Dialing Spacing and Duration**
Unit: 1 ms
Range: 1–255 (U.S.A.)
 80–255 (Canada, U.K., International)
Default: 70 (U.S.A.)
 80 (Canada, U.K., International)
- S11** sets the speed of tone dialing (spacing and tone duration times). The default value is 70 units for domestic models and 80 units for Canadian and International models, where each unit is one ms. In other words, for domestic modems, each tone is sustained for 70 ms followed by a 70 ms pause. The minimum **S11** value allowed by most telephone systems is 50 ms (50 units). Very few telephone systems can handle anything faster than that. The maximum S11 value is 255 ms (255 units).
- S13** **Remote Configuration Escape Character**
Unit: Decimal
Range: 0–127
Default: 37 (%)
- S13** defines the remote configuration escape character by its decimal ASCII code. The **S13** default is the percent character (decimal 37). When you enter the **S13**-defined character three consecutive times from a remote site, your modem responds with its remote configuration procedure. A value of 0 disables remote configuration.
- S17** **Changing Break Time**
Unit: 10 ms
Range: 1–255
Default: 25 (250 ms)
- S17** defines the break time (space) the modem sends the DTE when it receives a break signal from a remote modem. Break duration is adjustable in 10 millisecond increments. The default is set to 25, for a 250 millisecond break.
- S24** **PBX/CBX Disconnect Drop Time for DSR/CTS/CD**
Unit: 50 ms
Range: 0–255
Default: 20 (1 second)
- Some PBX and CBX phone systems require the modem's DSR, CTS, and/or CD signals to drop briefly when calls are disconnected. The MT2834MR6's **&R**, **&S**, and **&C** commands can cause the modem to drop these signals for a specified time upon disconnect, and then bring the signals up again. **S24** defines the length of time that the signals drop. The default setting of 20 results in a one-second drop time, which is what most PBX/CBX systems with this requirement need.
- S25** **DTR Dropout Time**
Unit: 100 ms
Range: 0, 1–255
Default: 0 (50 ms)
- S25** sets the amount of time that DTR must be dropped before the modem disconnects. Typically, a disconnect occurs when DTR is dropped for 50 milliseconds or more. This dropout time can be increased up to a maximum of 25.5 seconds. The S25 unit value for zero is 50 ms. For values from 1 through 255, the unit value is 100 ms.

- S30** **Inactivity Timer**
Unit: 1 minute
Range: 0, 1–255 minutes
Default: 0 (disabled)
S30 can be used to cause the modem to disconnect if no data is transmitted or received for a specified time. **S30** runs during both reliable and non-error correction connections. The timer restarts any time a data character passes through the serial port (either sent or received). If noise on the phone line causes an error to be received during non-error correction mode, this also will restart the **S30** timer. The factory default of zero disables the timer.
- S32** **Time Lapse for Escape Sequence**
Unit: 100 ms
Range: 0–255
Default: 20 (2 seconds)
S32 sets the time period to validate the escape sequence. If the **S32** time interval expires before you press ENTER, then the escape sequence is aborted. The default is two seconds.
- S34** **Command Buffer Length After Online Escape Sequence**
Unit: Decimal
Range: 0–60
Default: 10
Sets the number of characters allowed in an AT command after an in-band online escape (+++ method). If the number of characters after "AT" exceeds the **S34** buffer length value, then the buffer is flushed and the escape sequence is aborted.
- S36** **DTR Busy-Out Time**
Unit: 1 second
Range: 0–255
Default: 0 (disabled)
S36 sets the time between when DTR goes inactive and when the modem goes off-hook. The DTR busy-out feature is disabled when **S36** is set to 0.
Normally, when the DTR signal from the computer goes inactive, the modem goes on-hook after a time that is set by **S25**. If **S36** is set for a non-zero time, the modem then waits for the time set by **S36**; if DTR has not gone active again in that time, the modem goes off-hook, causing a busy signal for callers. The busy-out state ends when DTR goes active again.
- S37** **DTR Busy-In Time**
Unit: 1 second
Range: 0–255
Default: 5
S37 sets the time between when DTR goes active and when the modem goes on-hook, if **S36** has caused it to go off-hook.

S43 **Force V.34 Connect Speed**
Unit: N/A
Range: 0, 33, 31, 28, 26, 24, 21, 19, 16, 14, 12, 96, or 48
Default: 0 (disabled)
S43 forces the modem to attempt to connect at a fixed speed in V.34 mode. The two-digit value corresponds to the first two digits of the speed (**S43=21** sets the connect speed to 21.6K bps, **S43=96** sets it to 9600 bps, etc.). The factory default of zero disables this feature and allows the modem to establish the best speed for the conditions.

Note: The \$MB command overrides S43 if the \$MB command is set to a speed other than 33,600 bps.

S48 **Maximum V.34 Connect Speed**
Unit: N/A
Range: 0, 33, 31, 28, 26, 24, 21, 19, 16, 14, 12, 96, or 48
Default: 0 (disabled)
S48 sets the maximum speed in bps at which the modem can attempt to connect in V.34 mode. The two-digit value corresponds to the first two digits of the speed (**S48=26** sets the maximum connect speed to 26.4K bps, **S48=48** sets it to 4800 bps, etc.). This register allows you to set lower speeds for line conditions that will not support higher V.34 speeds such as 33.6K, 31.2K, 28K, 26.4K, or 24K. The factory default of zero disables this feature and allows the modem to establish the best speed for the conditions (in effect, it sets a maximum connection attempt of 33.6K).

S94 **Out-of-Service Time**
Unit: 1 second
Range: 0–254, 255
Default: 45
S94 sets the maximum number of seconds, from 0 through 254, that the modem remains out of service when the ***H1** command is active. A value of 255 causes the modem to remain out of service indefinitely. However, if the modem receives an enable command from the management program while the modem is out of service, the modem returns to service immediately, before the **S94** time expires.

4.3 Reading and Assigning S-Register Values

Use the **S** command to assign a value to an S-register and to read an S-register's current value.

To read an S-register value, in terminal mode, type **S**, the S-register number, and a question mark (?), and press ENTER. For example, to display the value of register **S7**, type **ATS7?** and press ENTER. The answer will appear as a three-digit decimal number (e.g., *045*).

To assign a new value to an S-register, type **S**, the S-register number, an equals sign (=), and a decimal number. Convert all ASCII characters to their decimal equivalents before entering them. S-register decimal values are 0–127 for ASCII characters, and 0–255 for numeric values. To make the change permanent, use the **&W0** command.

4.3.1 Examples of Assigning Values

1. **Example:** To assign longer pauses caused by the comma in a dial command—five seconds instead of two. Type **ATS8=5** to assign 5 as the value for register **S8**. The modem will now pause five seconds for every comma in a dial command.
2. **Example:** To configure the modem to answer incoming calls after the thirtieth ring instead of after the first ring. Configure register **S0** with a value of 30, type **ATS0=30** and press ENTER.
3. **Example:** International calls that take a long time to connect. The register **S7** (abort timer) factory default setting of 45 seconds is insufficient; the abort timer times out and cancels the call before a connection is made. To change the **S7** value to 55 seconds, type **ATS7=55** and press ENTER. Now, after dialing, the modem allows 10 more seconds for a carrier signal before aborting the call. The additional 10 seconds should provide enough time for international calls.

4.3.2 Examples of Reading Values

1. To verify that you entered the value correctly in the preceding examples, type **ATS8?** and press ENTER in the first example, **ATS0?** in the second example, and **ATS2?** in the third example. You should receive the responses *005*, *030*, and *055*, respectively.
2. When configuring S-registers, it is a good practice to include the verification read command in the same command string as the configuration assignment command. In the three preceding examples, type **ATS8=5S8?**, **ATS0=30S3?**, and **ATS7=55S7?**, respectively.

4.4 AT Commands Affecting S-Registers

For maximum throughput, the MT2834MR6's default configuration is for originating a call to another 33,600 bps modem that supports error correction, data compression, and flow control. If the receiving modem is not compatible, the MT2834MR6 can match any ITU-T or Bell standard modem (but not proprietary protocols).

If you require a different configuration for your application, for example, if you want to use an MT2834MR6 modem strictly as an autoanswering device, or for service that does not support error correction, you can selectively change the command parameters and S-register values in active memory and save the new values by using the **&W** command.

The **&W0** (or **&W**) command stores all current AT command and S-register values into nonvolatile random access memory (NVRAM) and configures the modem so that it reads your custom settings in NVRAM when the modem is turned on or when it is reset with the Z command. (The **&F** reset command will continue to read the factory default settings in read-only memory [ROM] unless you also store the **&F9** command. See Chapter 3.) For convenience, you can include the **&W** command in the same command string that sets the new values in active memory, as in the following example:

```
AT&E2$SP1#L3$R0$MB19200$SB115200$EB1S0=10&W0<CR>
```

The **&W1** command erases your custom settings in NVRAM the next time the modem is turned off or reset, causing the modem to read the factory default settings in ROM when it is subsequently turned on or reset.

For further information on how the **&W** command interacts with the reset commands, see Table 3-2.

Before you use the **&W** command, check the modem's current operating parameters by using the **L5**, **L6**, and **L7** commands.

Chapter 5 - Error Correction, Data Compression & Speed Conversion

5.1 Introduction

The MT2834MR6 has intelligent features beyond those of the AT command set described in Chapter 3. This chapter describes high performance features and commands that provide error correction, data compression and speed conversion capabilities. The remainder of this chapter describes these features and the commands that implement them, as well as related commands.

The MT2834MR6's error correction complies with the ITU-T V.42 standard. V.42 actually uses two error correction protocols: LAP-M and MNP Class 3 & 4. MNP Class 3 & 4 error correction emerged as the industry standard among modem manufacturers over the past decade. It is now in the public domain, and has been implemented in dozens of modem brands with world wide installations in the hundreds of thousands of units. LAP-M error correction is similar to MNP Class 3 & 4.

The MT2834MR6 provides two types of data compression: ITU-T V.42bis and MNP Class 5. V.42bis data compression is newer; it requires concurrent LAP-M error correction. V.42bis is a very efficient data compression technique that can provide up to 4-to-1 compression, depending on the type of data being transmitted. MNP Class 5 data compression requires concurrent MNP Class 3 & 4 error correction. It is an older and more established standard that offers data compression in the 2-to-1 range, which also depends on the type of data being transmitted.

Speed conversion allows the modem to operate at one speed over the telephone lines and another speed at the RS-232 serial port. This allows the computer or terminal to communicate with the modem at a fixed speed of up to 115,200 bps, while the modem operates at various speeds up to 33,600 bps. Speed conversion is vital if data compression is to be effective, since your terminal or computer must send data to the modem at a higher speed than the modem is sending it over the phone line.

5.2 How V.42 Detects and Corrects Errors

Some of the better known software-based error-correction protocols include Xmodem and Kermit (for asynchronous file transfer software), X.PC (Tymnet's asynchronous software protocol), and SDLC and HDLC, two popular synchronous protocols common in the IBM mainframe environment. V.42 is functionally similar to SDLC and HDLC, with some extras.

The main advantage of hardware-based V.42 error correction over these software-based protocols is in throughput. Throughput is the effect that the use of the protocol has on the overall data rate. For example, V.42 transmissions using a 2400 bps modem have an effective throughput of about 2600 bps. The same modem using software-based X.PC would have an effective throughput of less than 2400 bps. Another way of stating it is that V.42 has an efficiency of about 108%, while X.PC has an efficiency of about 91%.

Simply stated, one modem with V.42 sends coded data to another modem with V.42, and the receiving modem is able to determine if there are any errors. If there are, the receiving modem tells the sending modem to re-send the errant data until it's correct.

Technically speaking, when using V.42, the sending modem uses a polynomial function to calculate a 16-bit number that is a function of all the data sent in a particular message or block. It then sends those sixteen bits at the end of the block, which can include up to 256 characters. The other V.42 modem, as it is receiving the block, calculates its own version of the 16-bit number. Then it compares its number with the 16-bit number sent with the block. If the numbers are the same, the block is free from errors. If the numbers are different, an error has occurred somewhere in the block. That's how errors are *detected*.

Once an error is detected, the receiving modem's V.42 error *correction* is activated.

For all practical purposes, the result of the V.42 error correction protocol is error-free transmission. Using the 16-bit redundancy check, it will detect every error which is 16 bits or smaller with 100% probability. As a result, the chances of an error occurring are actually so small that you can ignore them.

5.3 Data Compression

The MT2834MR6 has both V.42bis and MNP class 5 data compression. ITU-T V.42bis is an international data compression standard that can provide data compression of up to four to one in certain types of data. MNP class 5 is a proprietary technique for data compression that provides a data compression capability of two-to-one.

The MT2834MR6 must be in error correction mode before it can compress data (LAP-M error correction for V.42bis data compression or MNP error correction for MNP 5 data compression). By using the **#L** command, you can select which error correction to use.

The type of file transfer protocol used to send and receive data has a big effect on the speed gain due to compression. In general, a protocol that uses large data blocks transfers files quicker. For example, YMODEM sends 1000 characters per block. It also helps to have the serial port of the receiving modem set to the highest possible speed (115,200 bps), if the sending modem is set to a lower speed.

To achieve a data rate that is higher than the modem baud rate, turn Baud Adjust off (**\$BA0**) and operate the serial port at a higher speed than the modem baud rate. For the MT2834MR6, set the serial port to 115,200 bps (**\$SB115200**).

Data compression works by locating repeated strings of characters and repeating these strings using shorter codewords. To use data compression, the modem must be driven at full capacity. In other words, the data must be present at enough volume and speed to get maximum compression benefits, as when using file transfers or batch operations. Speed conversion must be on to operate the port at a higher speed than the modem connection speed.

When operating the serial port at a higher speed than the modem baud rate, some type of flow control must be used, otherwise data can be lost. (See **&E4** and **&E5** commands.)

To enable data compression, type **AT&E15** and press ENTER; to disable data compression, type **AT&E14** and press ENTER.

Note: For data compression to take place, both the answer and the originate modems must have data compression and error correction enabled.

5.4 MNP Classes

The MNP protocol is divided into several classes. The classes you might encounter today in full duplex dial-up in 1200, 2400 and 9600 bps modems are Classes 3 through 5. When modems equipped with MNP start communicating, they negotiate operation to the highest common MNP class between them and operate at that level.

5.5 V.42 Mode Select Command (#L)

The V.42 Mode Select command (**#L**) selects which type of error correction your MT2834MR6 will use for transmissions. The V.42 standard implements both MNP Class 3 & 4 and LAP-M error correction protocols. When you execute one of the **#L** commands, you instruct your MT2834MR6 how to operate with each protocol. For example, the factory default setting (**#L0**) tells your MT2834MR6 to negotiate the protocol with the remote modem.

The following sections detail the operation of the **#Ln** command.

5.5.1 #L0 Command

The **#L0** command, which is the factory default, allows a pair of modems to negotiate which V.42 mode (MNP or LAP-M) will be used.

5.5.1.1 Originate Mode

If both modems have LAP-M capability, the modems will use LAP-M mode. If one or both modems do not have LAP-M capability and both have MNP, the modems will use the MNP.

5.5.1.2 Answer Mode

The answering modem will respond to either an MNP Link Request or a LAP-M ODP signal, depending on which is issued by the originating modem.

5.5.2 #L1 Command

The **#L1** command enables MNP error correction and disables LAP-M. This command is for originate mode only. Answer mode still accepts MNP or LAP-M.

5.5.3 #L2 Command

The **#L2** command enables LAP-M error correction and disables MNP. This command is for originate mode only. Answer mode still accepts MNP or LAP-M.

5.5.4 #L3 Command

In the previous commands, the modems use a two-phase process to establish a V.42 connection (“Detection” to establish whether the remote modem is also error correcting, and “Protocol Establishment” to determine parameters and establish the error correction connection). If you know that the other modem is a V.42 error-correcting modem, and you wish to use LAP-M, use the **#L3** command to disable the Detection phase and go directly to Protocol Establishment. Both modems must have **#L3** in effect.

5.6 Modes of Operation

You can configure your MT2834MR6 in one of three different V.42 modes of operation, each with or without compression. They are the non-error correction, reliable, and autoreliable modes. The modes and data compression features are selected with commands described later in this chapter in “Compression, Error Correction, Flow Control, Pass Through, and Pacing Commands.”

5.6.1 Non-Error Correction Mode (&E0)

In the non-error correction mode of operation, the MT2834MR6's error correction capabilities are disabled, and the modem functions as a non-error-correcting modem.

5.6.2 Reliable Mode (&E2)

In reliable mode, the MT2834MR6 uses its V.42 error correction capabilities during all transmissions. When in reliable mode, the MT2834MR6 must be connected to a modem with a similar V.42 protocol activated (MNP or LAPM). If the modems cannot establish a V.42 error correction connection, the MT2834MR6 will time out and hang up.

5.6.3 Autoreliable Mode (&E1)

In autoreliable mode, the MT2834MR6 automatically determines, during the handshake at the start of the online connection, whether or not the other modem is using error correction. If the MT2834MR6 determines that the other modem is using V.42, it switches itself into the reliable (V.42) mode of operation. If it determines that the other modem is not using V.42, the MT2834MR6 remains in non-error correction mode.

The MT2834MR6 uses a “Link Request” to determine whether the other modem is using V.42 error correction. When the MT2834MR6 is in autoreliable mode and originates a call, it goes through normal handshaking procedures. After establishing the online connection, the MT2834MR6 transmits a Link Request message to the answering modem. If the answering modem replies with an appropriate V.42 acknowledgment response, the MT2834MR6 switches into reliable mode. Otherwise, it remains in non-error correction mode. This V.42 handshake procedure generally takes about five seconds.

When operating in V.42 reliable mode, the MT2834MR6 stores data in a buffer as it is received. During periods of error-caused retransmissions or compression slowdowns, this buffer may fill up. To prevent buffer overflow and subsequent loss of data, the modem uses flow control to signal the computer attached to its RS-232 port that the modem buffer is close to being full. This causes the computer to pause in its data transmission until the modem is able to empty its buffer sufficiently to accept more data, at which time the modem signals the computer that it may resume transmission.

5.7 Flow Control

Flow control refers to the techniques used by computer devices to stop and restart the flow of data from each other. Flow control is necessary so that a device does not receive more data than it can handle. In the case of the MT2834MR6, there is a need for flow control in both directions. Flow control for data passing from your computer to the modem is called modem-initiated flow control, and flow control for data passing from the modem to your computer is called computer/terminal-initiated pacing (see Figure 5-1).

The MT2834MR6 supports both hardware and software modem-initiated flow control and computer/terminal-initiated pacing. It also supports Hewlett Packard ENQ/ACK pacing. The MT2834MR6 can allow hardware and software pacing to be passed through the modem to the other end of the link so that your computer or terminal can control data start/stop activity through your modem. This is called "XON/XOFF pass-through".

To put it simply, flow control is something the modem does to the computer, while pacing is something the computer does to the modem.

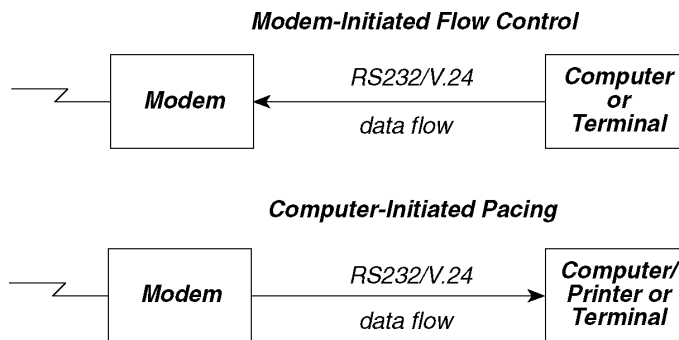

Figure 5-1. Flow control and pacing

5.8 Modem-Initiated Flow Control

When operating in V.42 reliable mode, the MT2834MR6 stores data in a buffer as it is received. During periods of error-caused retransmissions or compression slowdowns, this buffer may fill up. To prevent buffer overflow and subsequent loss of data, the modem uses flow control to signal the computer attached to its RS-232 port that the modem buffer is close to being full. This causes the computer to pause in its data transmission until the modem is able to empty its buffer sufficiently to accept more data, at which time the modem signals the computer that it may resume transmission.

The MT2834MR6 can use either of two methods of modem-initiated flow control: software flow control, which uses special XON and XOFF characters in the data transmissions, and hardware flow control, which uses the CTS output on the RS-232 interface. Most terminals and computers support one or both of these methods.

5.8.1 XON/XOFF Flow Control (&E5)

In this method, control characters known as XON and XOFF are inserted by the modem into the flow of data from the serial port. XOFF (CTRL-S), stops the flow of data, and XON (CTRL-Q), restarts it. XOFF/XON flow control is not recommended for binary data, because an XOFF character could be part of the data, and would halt data flow.

5.8.2 Hardware Flow Control (&E4)

With hardware flow control, the modem uses the RS-232 interface to control the flow of data on the serial port. The CTS (Clear to Send) signal on Pin 5 of the RS-232 interface is brought low to stop the flow of data, and is brought high to restart it.

When you select hardware flow control as your flow control method, you select it also for pacing. The difference between the two is that flow control uses the CTS output signal, while pacing uses the RTS input signal.

5.9 Pacing (&E13)

As mentioned earlier, the MT2834MR6 can initiate flow control by issuing XON/XOFF commands or by toggling the CTS signal on the RS-232 interface. The modem can also be configured to react to similar commands and signals from the computer or terminal to which it is connected by the RS-232 interface.

Pacing is computer-initiated flow control. When pacing is enabled on the modem, the modem responds to the terminal or computer pacing. When pacing is disabled on the modem, the modem ignores pacing.

Before you enable pacing on the MT2834MR6, you must select a flow control method. When pacing is enabled, the MT2834MR6 responds either to XON/XOFF commands, or to the toggling of the RTS (Request to Send) signal on Pin 4 of the RS-232 interface, depending on what you selected as your flow control method.

5.9.1 XON/XOFF Pass-Through (&E7)

So far, you have had three choices to make regarding pacing. You can set the modem to respond to XON/XOFF pacing, or to respond to RTS pacing, or you can set the modem to ignore pacing completely.

Another choice you can make (which actually can apply to both pacing and flow control, although it applies mainly to pacing) is XON/XOFF pass-through. If your modem is set to respond to XON/XOFF commands, you can have the modem do one of the following.

- a. The modem responds to the XON and XOFF pacing commands while at the same time allowing these commands to pass through the modem and on to the remote location. We call this "respond, pass-through."
- b. The modem responds to XON/XOFF pacing, but does not allow the pacing signals to pass through the modem and on to the remote location. We call this "respond, no pass-through."

When XON and XOFF commands are allowed to pass through the modem, the computer at the remote site receives these commands, and depending on how it is configured, the computer may respond to them also.

5.9.2 Non-Error Correction Mode Flow Control (&E10 and &E11)

You can use XON/XOFF to control the flow of data between two MT2834MR6s that are connected in non-error correction mode. Disable or enable this method of flow control by using the Non-Error Correction Mode Flow Control commands. When the modems are connected in reliable mode, a different method of modem flow control is used, and the commands for non-error correction mode flow control are ignored.

You must enable non-error correction mode flow control if you use speed conversion in non-error correction mode.

5.9.3 Hewlett Packard ENQ/ACK Pacing (&E9)

If the MT2834MR6 is used with Hewlett Packard or similar equipment that employs ENQ/ACK pacing, you can configure it to respond to the ENQ/ACK commands used by Hewlett Packard systems. Doing so does not effect any other flow control or pacing already configured in the modem.

When the MT2834MR6 is configured for ENQ/ACK, the ENQ (Ctrl-E) and ACK (Ctrl-F) signals from the HP equipment will be accepted and responded to according to the Hewlett Packard protocol.

5.10 Compression, Error Correction, Flow Control, and Pacing Commands

The MT2834MR6 has several commands that control error correction, data compression, and flow control:

5.10.1 V.42 Error Correction Modes

- &E0** Non-auto correction mode (no error correction).
- &E1** Autoreliable mode (factory default).
- &E2** Reliable mode.

5.10.2 Modem-Initiated Flow Control

- &E3** Disable flow control.
- &E4** CTS/RTS hardware flow control (factory default).
- &E5** XON/XOFF software flow control.

5.10.3 XON/XOFF Pass-Through

- &E6** Respond to and discard XON/XOFF characters when **&E5** is selected (factory default).
- &E7** Respond to and pass through XON/XOFF characters when **&E5** is selected.

5.10.4 Hewlett Packard ENQ/ACK Pacing

- &E8** Ignore ENQ/ACK pacing characters (factory default).
- &E9** Respond to ENQ/ACK pacing characters.

5.10.5 Non-Error Correction Mode Flow Control

- &E10** Non-error correction mode flow control off (factory default).
- &E11** Non-error correction mode flow control on.

5.10.6 Pacing (Computer-Initiated Flow Control)

- &E12** Pacing off.
- &E13** Pacing on (factory default).

5.10.7 Data Compression

- &E14** Data Compression disabled.
- &E15** Data Compression enabled.*

* The factory default setting for data compression is enabled, but the modem will not compress data unless **&E1** (autoreliable mode) or **&E2** (reliable mode) is also selected.

5.11 Result Codes

When the MT2834MR6 connects with another modem with error-correction or data compression enabled, its *CONNECT* responses change to inform you of the type of connection. (See Appendix C for a complete list of result codes.)

5.11.1 MNP Error Correction

If terse responses are enabled, an *R* is added to the numeric code. If verbose responses are enabled, the word *RELIABLE* follows the *CONNECT* message.

5.11.2 LAP-M Error Correction

If terse responses are enabled, an *L* is added to the numeric code. If verbose responses are enabled, the word *LAPM* follows the *CONNECT* message.

5.11.3 Data Compression

If terse responses are enabled, a *C* is added to the numeric code. If verbose responses are enabled, the word *COMPRESSED* follows the *CONNECT* message.

5.12 Speed Conversion

Speed conversion allows the MT2834MR6 to communicate at one speed over the phone line, and at another speed at the RS-232 interface. The speed (baud rate) of the RS-232 interface, in bits per second (bps) can be fixed independently of the speed of the online transmissions.

Besides data compression, another popular application for speed conversion involves an autoanswer MT2834MR6 connected to a computer that does not have autobauding capability. This means that the computer must be set at a fixed baud rate, regardless of whether the modem is communicating over the phone line at 300, 1200, 2400, 4800, 9600, 14,400, 19,200, 21,600, 24,000, 26,400, or 28,800 bps. In this application, speed conversion allows the modem to match its speed to that of a calling modem, while at the same time communicating with the attached computer through its RS-232 serial port at a fixed baud rate, which can be preselected at 300, 1200, 2400, 4800, 9600, 19,200, 38,400, 57,600, or 115,200 bps.

The flow control and pacing methods used between the computer and the modem during speed conversion are the same as those used with V.42 error correction. The two choices (XON/XOFF or RTS/CTS) are selected by using the **&E** commands detailed earlier in this chapter. If you are not using the modem's V.42 error correction, you must activate modem flow control with a separate command (**&E11**), as explained earlier.

There are three commands that relate specifically to speed conversion. They are the Baud Adjust (**\$BA**), Modem Baud Rate (**\$MB**) and Serial Port Baud Rate (**\$SB**) commands.

5.12.1 Baud Adjust (**\$BA**)

In typical operations, the MT2834MR6 will do one of two things regarding speed. It will automatically match the speed of its RS-232 interface and phone line transmissions to that of the terminal or computer to which it is connected as soon as it receives its first AT command. Or, in autoanswer mode, it will match its RS-232 and transmission speeds to that of the originating modem that called it. This is typical of many dial-up modems, and it is referred to variously as *auto-speed* or *baud adjust*. Multi-Tech uses the term *baud adjust*.

When you enable speed conversion, the modem does not adjust its speed at the RS-232 serial port, even if the modem does adjust its line transmission speed. To turn baud adjust off and speed conversion on, type **AT\$BA0** (where the 0 is a zero).

Note: Even though baud adjust sounds like it should mean the same thing as speed conversion, it actually means the opposite.

- a. Turning baud adjust *off* turns speed conversion *on*.
- b. Turning baud adjust *on* turns speed conversion *off*.

To turn baud adjust on and speed conversion off, type **AT\$BA1** and press ENTER. The modem will now match its RS-232 speed to that of the computer, and will adjust its speed to any changes in the computer's speed in the originate mode, or to the speed of the originating modem when it's in the answer mode. With baud adjust on, the speed at which the modem communicates over the phone line is always the same as the speed at which it communicates via its RS-232 serial port.

5.12.2 Modem Baud Rate (**\$MB**)

The \$MB command presets the MT2834MR6's transmission rate for originate operations, i.e., the speed of the modem's transmissions over the telephone lines when originating a call. With speed conversion, this transmission speed can be a different rate than the serial port speed.

When the MT2834MR6 receives a call from another modem, it automatically switches its phone line transmission rate to match the calling modem. However, if the MT2834MR6 originates a call to another modem that is unable to connect at the speed of the MT2834MR6, the MT2834MR6 will automatically drop to a lower speed in an attempt to match the speed of that modem. For example, if the MT2834MR6 is set for 28,800 bps and calls another modem that has a top speed of 9600 bps, it will drop to 9600 bps.

When baud adjust is on (**\$BA1**), speed conversion is off, as we discussed earlier. In that case, the **\$MB** command is ignored, since it is part of speed conversion.

To set the Modem Baud Rate, type **AT\$MBn**, where n is the desired rate.

AT\$MB75	ITU-T V.23	AT\$MB300	300 bps
AT\$MB1200	1200 bps	AT\$MB2400	2400 bps
AT\$MB4800	4800 bps	AT\$MB9600	9600 bps
AT\$MB14400	14,400 bps	AT\$MB16800	16,800 bps
AT\$MB19200	19,200 bps	AT\$MB28800	28,800 bps
AT\$MB33600	33,600 bps (factory default)		

5.12.3 Serial Port Baud Rate (\$SB)

The **\$SB** command presets the speed of the MT2834MR6's RS-232 serial port in both the originate and the answer modes. Speed conversion allows you to set this serial port baud rate at a fixed speed of up to 115,200 bps, regardless of the modem's transmission speed setting. It also sets the default speed at which the modem issues command responses (result codes).

For this command to work, the modem's baud adjust feature must be turned off with the **\$BA** command.

The MT2834MR6 will accept AT commands at any speed, regardless of the speed preset by the **\$SB** command. If the modem receives such a command at a speed that is different from the preset speed, the modem switches its serial port baud rate to match the new AT command speed, although the baud rate value stored by the **\$SB** command remains the same. This provides you with a convenient way to switch the serial port speed, while still making it easy to automatically return to the original speed the next time the modem is powered up, or reset using the **ATZ** command.

To set the serial port baud rate, type **AT\$SBn**, where n can be 300, 1200, 2400, 4800, 9600, 19,200, 38,400, 57,600, or 115,200 bps as listed below:

AT\$SB300	300 bps	AT\$SB1200	1200 bps
AT\$SB2400	2400 bps	AT\$SB4800	4800 bps
AT\$SB9600	9600 bps	AT\$SB19200	19200 bps
AT\$SB38400	38400 bps	AT\$SB57600	57,600 bps
AT\$SB115200	115,200 bps (factory default)		

5.13 Related Commands

5.13.1 Autoreliable Buffering (\$A)

In autoreliable mode, the modem is given four seconds to establish a reliable connection. If it cannot establish a reliable connection in that time, the modem drops to non-error correction mode. Any data received during this period is normally discarded. The **\$A** command is used to cause the modem to buffer (save) data that is received during the autoreliable time-out period. This data is then output by the modem after it sends the CONNECT message.

Type **AT\$A0** to discard data received during the autoreliable time period (factory default).

Type **AT\$A1** to buffer data received during the autoreliable time period.

5.13.2 Maximum Block Size (&BS)

The maximum size of reliable mode data blocks is controlled by the **&BS** command. MNP Class 3 sends blocks of 1 to 64 characters. MNP Classes 4 and 5 normally send blocks of 1 to 256 characters. Reducing the block size for Classes 4 and 5 to 64 characters may give a smoother flow of data, and improve throughput performance on noisy phone lines. Using smaller block sizes over good phone lines may cause a slight loss in data throughput.

Type **AT&BS0** for a maximum transmit block size of 64 characters.

Type **AT&BS1** for a maximum transmit block size of 256 characters (factory default).

5.13.3 Autoreliable Fallback Character (\$F)

In autoreliable mode, the modem is given four seconds to establish a reliable connection. If a single carriage return character, <CR>, is received from the remote modem during this four second period, the autoreliable modem assumes that the remote modem is not in reliable mode and drops to a non-error correction mode. The carriage return character is then output following the CONNECT message. The carriage return character is the only character that causes the modem to drop to non-error correction mode. Any other data is either buffered or discarded.

Use the **\$F** command to disable this fallback feature. The autoreliable fallback character (**\$F**) and the autoreliable buffering (**\$A**) commands can be used together to cause the modem to buffer all data received up to the carriage return and then drop to non-error correction mode. All data received will then be output following the CONNECT message.

Type **AT\$F0** to cause the modem not to fall back to non-error correction mode if a carriage return character is received.

Type **AT\$F1** to cause the modem to fall back to error correction mode if a carriage return character is received (factory default).

5.13.4 Retransmit Count (\$R)

If errors are received during a reliable connection, the modem resends the block of data that contained errors. If another error occurs, the block is re-sent again. The modem counts the number of times that a data block is re-sent. If the same block of data is re-sent 12 times and still has not been received properly, the modem aborts the connection, as dictated by the **AT\$R0** command.

This retransmit counter can be disabled with the **\$R1** command. When the retransmit counter is disabled, the modem keeps trying to send data and will not abort, no matter how many times the same block is re-sent.

Type **AT\$R0** to disconnect if the retransmit count is exceeded (factory default).

Type **AT\$R1** to not disconnect because of excessive retransmits.

5.13.5 V.42 Error Correction at 300 bps (\$E)

At 300 bps, error correction is not normally used. **\$E1** lets the MT2834MR6 function in either non-error correction (**&E0**), autoreliable (**&E1**) or reliable (**&E2**) mode at 300 bps. **\$E0**, which is the factory default setting, disables V.42 error correction at 300 bps altogether.

5.14 Summary

V.42 error correction is built into the MT2834MR6's hardware, and detects virtually 100 percent of transmission errors, which are usually caused by noisy phone lines. When errors are detected, the V.42 protocol causes the modem to retransmit the errant data block.

V.42bis and MNP data compression, also built into the MT2834MR6's hardware, provides an effective throughput higher than the modem's transmission speed. The amount of increase depends on the type of data being transmitted.

The MNP protocol is divided into several classes, which for our purposes are numbered 3 through 5. The MT2834MR6 uses all of these MNP classes, which yields higher throughput and error-free transmissions. LAP-M provides another type of error correction.

The MT2834MR6 can be set for three different modes of operation. Non-error correction mode disables error correction, reliable mode enables it, and autoreliable mode allows the modem to automatically turn V.42 on when it detects its use in another modem.

Flow control methods are used by the MT2834MR6 to prevent data loss from buffer overflow. The modem can both initiate it (flow control) and respond to it (pacing), using either XON/XOFF commands or RS-232 signaling via the serial port's CTS and RTS signals. Hewlett Packard ENQ/ACK pacing is also supported. If needed, XON/XOFF commands can be "passed through" the modem to a remote computer or terminal.

Speed conversion allows the MT2834MR6 to operate at one speed over the telephone lines and another speed at the RS-232 serial port, allowing the computer or terminal to communicate with the modem at a fixed speed of up to 115,200 bps, while the modem operates at various speeds up to 33,600 bps. This ability is for data compression, since your terminal or computer must present data to the modem at a higher speed than the modem sends it over the phone line.

Chapter 6 - Testing & Troubleshooting

6.1 Introduction

Each time you power up the MT2834MR6, it performs an automatic self-test to ensure proper operation. The MT2834MR6 also has three diagnostic tests: local analog loopback, digital loopback (remote/automatic), and digital loopback (local/manual). These ITU-T V.54 loopback tests isolate telephone circuit and transmission problems.

In a loopback test, data from your computer loops through the circuits of your modem and/or a remote modem before it appears on your monitor. When the loop has been completed, the data on your PC's monitor should match the original data.

The local analog loopback test allows you to verify that the modem's transmitter and receiver circuits are functioning properly.

The local digital loopback allows you to verify that the local computer or terminal, the two modems, and the transmission line between them are functioning properly.

The remote digital loopback test allows you to verify that the remote computer or terminal, the remote modem, the serial ports, the telephone line, and the local modem are functioning properly.

Note: Loopback tests operate at all speeds except 300 bps.

Other tests are initiated with the MultiModemManager software, as explained in the MultiModemManager Owner's Manual.

6.2 Local Analog Loopback Test (V.54 Loop 3)

In this test, data from your computer or terminal is sent to your modem's transmitter, converted into analog form, looped back to the modem's receiver, converted into digital form, and then sent to your monitor for verification. No connection to the phone line is required. See Figure 6-1.

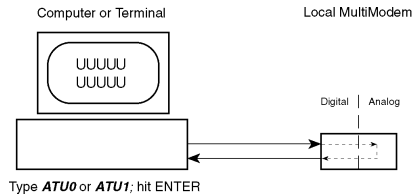

Figure 6-1. Local analog loopback test.

6.2.1 Test Procedure

1. Connect the modem to your computer. Using your communication software, set the desired baud rate.
2. Type **ATU** or **ATU0** and press ENTER. This places your modem in analog loopback mode in the originate mode. A *CONNECT* message should appear on your display. The modem is now out of command mode and in a pseudo-online mode.
3. Note that the CD LED is on. If you're set for 14,400 bps or higher, the Speed LED should be on. If the CD LED is not on, there is a defect in your modem.
4. Enter characters from your keyboard. For this test, typing multiple uppercase *U* characters is a good way to send an alternating test pattern of binary ones and zeros. The characters entered should be displayed on your monitor. The TD and RD LEDs should flash when a character is entered.
5. For a more complete test, you should also test the modem in answer mode. To do this, you must first terminate the originate mode by entering an escape sequence (**+++AT<CR>** or **<BREAK>AT<CR>**). An *OK* should appear on your display. Then type **ATU1** and press ENTER to place the modem in analog loopback in answer mode.
6. Note that the CD LED is on. If you're set for 14,400 bps or higher, the Speed LED should be on. If the CD LED is not on, there is a defect in your modem.
7. Enter characters from your keyboard. Type multiple uppercase *U* characters to send an alternating test pattern of binary ones and zeros. The characters entered should be displayed on your monitor. The TD and RD LEDs should flash when a character is entered.
8. To exit the test, enter an escape sequence (**+++AT<CR>** or **<BREAK>AT<CR>**), which returns the modem to command mode.
9. Your modem passes this test if the data received on your monitor are the same as the data entered from your keyboard. If different data appear on your monitor, your modem is probably causing the problem, though it could also be your computer. If your modem passes this test, but you are receiving errors while on line, the remote modem or the phone line could be at fault.

6.3 Remote Digital Loopback Test (V.54 Loop 2)

In this test, your modem must be online with another modem, such as another ZDX, that is set up to respond to a request for remote digital loopback. With the ZDX, this ability to respond is controlled by the **&T** command. **AT&T4** enables the response to remote digital loopback; **AT&T5** disables the response. The modem defaults to **&T5** on power-up, so this must be changed on the remote modem before initiating remote digital loopback.

Initiate remote digital loopback with the **ATU2** command, which places the remote modem in digital loopback mode. Data from your computer or terminal are transmitted through your modem and over the phone line to the remote modem, where they are then looped back to your modem. See Figure 6-2.

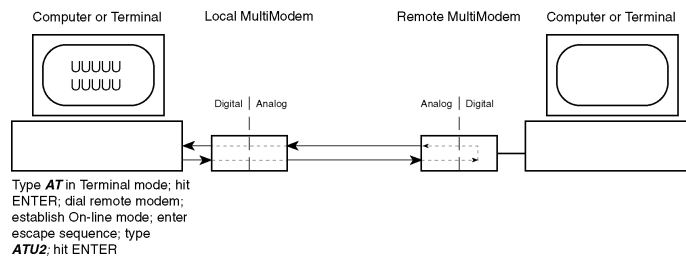

Figure 6-2. Remote digital loopback test.

6.3.1 Test Procedure

1. Arrange to have **&T4** set on the remote test modem.
2. Open your communications software and go into terminal mode. Type **AT** and press ENTER; you should get an *OK* message. Type **AT&E0<CR>** to disable error correction.
3. Dial the remote modem and establish your online connection.
4. Type the escape sequence (**+++AT<CR>** or **<BREAK>AT<CR>**) to bring your modem into command mode while maintaining the connection with the remote modem.
5. Type **ATU2** and press ENTER. The local modem responds to this command by transmitting an unscrambled marking signal, which causes the remote modem to place itself in digital loopback mode. Then the local modem exits command mode and enters online mode.
6. Enter data from your keyboard. For this test, typing multiple uppercase *U* characters is a good way to send an alternating test pattern of binary ones and zeroes. Data received by the remote modem enters its analog receiver, is converted to digital data, is reconverted into analog, and then is transmitted back to your modem. Your modem passes this test if the data received on your monitor is the same as the data entered from your keyboard.
7. To exit the test, enter an escape sequence (**+++AT<CR>** or **<BREAK>AT<CR>**), which returns the modem to command mode. The modem should respond with an *OK* message. If you wish to stay on line with the remote modem for normal data transmission, type **ATO** and press ENTER. If you wish to terminate the call, type **ATH** and press ENTER to hang up.

6.4 Local Digital Loopback Test (V.54 Loop 2)

This test is identical to the remote digital loopback test with one exception. Instead of using your modem to signal a remote modem to place itself in digital loopback mode, your modem is placed in digital loopback mode while the remote modem is not. Data is entered and transmitted from the remote modem, sent across the phone line to the local modem, and looped back to the remote modem. See Figure 6-3.

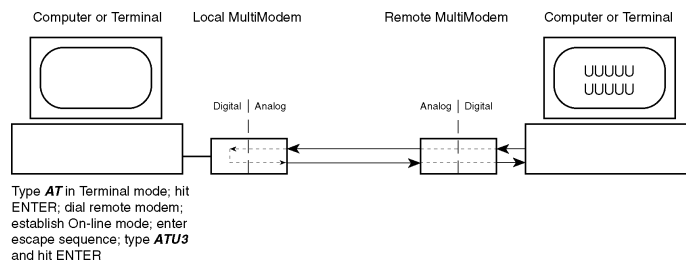

Figure 6-3. Local digital loopback test

6.4.1 Test Procedure

1. Open your communications software and go into terminal mode. Type **AT** and press ENTER; you should get an *OK* message. Enter **AT&E0<CR>** to disable error correction.
2. Dial the remote modem and establish your online connection.
3. Type an escape sequence (**+++AT<CR>** or **<BREAK>AT<CR>**) to bring your modem into command mode while still maintaining the connection with the remote modem.
4. Type **ATU3** and press ENTER. Once you receive an *OK* message from your modem (if responses are enabled), your modem is placed in digital loopback mode.
5. Have someone enter data from the remote keyboard. For this test, typing multiple uppercase *U* characters is a good way to send an alternating test pattern of binary ones and zeros. The data received by your modem enters its analog receiver, is converted to digital data, is reconverted into analog, and then is transmitted back to the remote modem. Your modem passes this test if the data received on the remote monitor is the same as the data entered from the remote keyboard.
6. To exit the test, enter an escape sequence (**+++AT<CR>** or **<BREAK>AT<CR>**), which returns the modem to command mode. The modem should respond with an *OK* message. If you wish to stay on line with the remote modem for normal data transmission, type **ATO** and press ENTER. If you wish to terminate the call, type **ATH** and press ENTER to hang up.

Chapter 7 - Warranty & Service

7.1 Multi-Tech Systems, Inc. Warranty & Repairs Policies

7.1.1 Warranty

Multi-Tech Systems, Inc., (hereafter “MTS”) warrants that its products will be free from defects in material or workmanship for a period of two, five, or ten years (depending on model) from date of purchase, or if proof of purchase is not provided, two, five, or ten years (depending on model) from date of shipment.

MTS MAKES NO OTHER WARRANTY, EXPRESS OR IMPLIED, AND ALL IMPLIED WARRANTIES OF MERCHANTABILITY AND FITNESS FOR A PARTICULAR PURPOSE ARE HEREBY DISCLAIMED.

This warranty does not apply to any products which have been damaged by lightning storms, water, or power surges or which have been neglected, altered, abused, used for a purpose other than the one for which they were manufactured, repaired by Customer or any party without MTS’s written authorization, or used in any manner inconsistent with MTS’s instructions.

MTS’s entire obligation under this warranty shall be limited (at MTS’s option) to repair or replacement of any products which prove to be defective within the warranty period or, at MTS’s option, issuance of a refund of the purchase price. Defective products must be returned by Customer to MTS’s factory – transportation prepaid.

MTS WILL NOT BE LIABLE FOR CONSEQUENTIAL DAMAGES, AND UNDER NO CIRCUMSTANCES WILL ITS LIABILITY EXCEED THE PRICE FOR DEFECTIVE PRODUCTS.

7.1.2 U.S. and Canadian Customers

In the event that service is required, products may be shipped, freight prepaid, to our Mounds View, Minnesota, factory:

Multi-Tech Systems, Inc.
2205 Woodale Drive
Mounds View, MN 55112
Attn: Repairs, Serial #_____

A Returned Materials Authorization (RMA) is not required. Return shipping charges (surface) will be paid by MTS. Please include inside the shipping box a description of the problem, a return shipping address (must have street address, not P.O. Box), a telephone number, and if the product is out of warranty, a check or purchase order for repair charges.

For out of warranty repair charges, go to: www.multitech.com. Extended two-year overnight replacement agreements are available for selected products. Please call MTS at 888 288-5470, extension 5308, or visit our web site at www.multitech.com for details on rates and coverages.

Please direct your questions regarding technical matters, product configuration, verification that the product is defective, etc., to our Technical Support department at 800 972-2439 or e-mail tsupport@multitech.com. Please direct your questions regarding repair expediting, receiving, shipping, billing, etc., to our Repair Accounting department at 800 328-9717 or +763 785-3500, or e-mail mtsrepair@multitech.com.

Repairs for damages caused by lightning storms, water, power surges, incorrect installation, physical abuse, or user-caused damages are billed on a time-plus-materials basis.

7.1.3 International Customers (outside U.S.A. and Canada)

Your original point of purchase reseller may offer the quickest and most economical repair option for your Multi-Tech product. You may also contact any Multi-Tech sales office for information about the nearest distributor or other repair service for your Multi-Tech product: www.multitech.com.

In the event that factory service is required, products may be shipped, freight prepaid, to our Mounds View, Minnesota, factory. Recommended international shipment methods are via Federal Express, UPS or DHL courier services, or by airmail parcel post; shipments made by any other method will be refused. A Returned Materials Authorization (RMA) is required for products shipped from outside the U.S.A. and Canada. Please contact us for return authorization and shipping instructions on any international shipments to the U.S.A.

Please include inside the shipping box a description of the problem, a return shipping address (must have street address, not P.O. Box), your telephone number, and if the product is out of warranty, a check drawn on a U.S. bank or your company's purchase order for repair charges. Repaired units will be shipped freight collect, unless other arrangements are made in advance.

Please direct questions regarding technical matters, product configuration, verification that the product is defective, etc., to our Technical Support department nearest you, as listed at <http://www.multitech.com/COMPANY/offices/DEFAULT.ASP>, or e-mail tsupport@multitech.com. When calling the U.S., please direct questions regarding repair expediting, receiving, shipping, billing, etc., to our Repair Accounting department at +763 717-5631 in the U.S.A., or e-mail mtsrepair@multitech.com.

Repairs for damages caused by lightning storms, water, power surges, incorrect installation, physical abuse, or user-caused damages are billed on a time-plus-materials basis.

7.1.4 International Distributors

Procedures for international distributors of Multi-Tech products are on the Distributor Web site at <http://www.multitech.com/PARTNERS/login/>.

7.2 Repairs

7.2.1 Repair Procedures for U.S. and Canadian Customers

In the event that service is required, products may be shipped, freight prepaid, to our Mounds View, Minnesota factory:

Multi-Tech Systems, Inc.
2205 Woodale Drive
Mounds View, MN 55112
Attn: Repairs, Serial # _____

A Returned Materials Authorization (RMA) is not required. Return shipping charges (surface) will be paid by MTS. Please include, inside the shipping box, a description of the problem, a return shipping address (must have street address, not P.O. Box), your telephone number, and if the product is out of warranty, a check or purchase order for repair charges. For out of warranty repair charges, go to www.multitech.com

Extended two-year overnight replacement service agreements are available for selected products. Please call MTS at (888) 288-5470, extension 5308 or visit our web site at: www.multitech.com for details on rates and coverages.

Please direct your questions regarding technical matters, product configuration, verification that the product is defective, etc., to our Technical Support department at (800) 972-2439 or email tsupport@multitech.com. Please direct your questions regarding repair expediting, receiving, shipping, billing, etc., to our Repair Accounting department at (800) 328-9717 or (763) 717-5631, or email mtsrepair@multitech.com.

Repairs for damages caused by lightning storms, water, power surges, incorrect installation, physical abuse, or user-caused damages are billed on a time-plus-materials basis.

7.2.2 Repair Procedures for International Customers

Your original point of purchase Reseller may offer the quickest and most economical repair option for your Multi-Tech product. You may also contact any Multi-Tech sales office for information about the nearest distributor or other repair service for your Multi-Tech product. Visit our website at: www.multitech.com

In the event that factory service is required, products may be shipped, freight prepaid to our Mounds View, Minnesota factory. Recommended international shipment methods are via Federal Express, UPS or DHL courier services, or by airmail parcel post; shipments made by any other method will be refused. A Returned Materials Authorization (RMA) is required for products shipped from outside the U.S.A. and Canada. Please contact us for return authorization and shipping instructions on any International shipments to the U.S.A. Please include, inside the shipping box, a description of the problem, a return shipping address (must have street address, not P.O. Box), your telephone number, and if the product is out of warranty, a check drawn on a U.S. bank or your company's purchase order for repair charges. Repaired units shall be shipped freight collect, unless other arrangements are made in advance.

Please direct your questions regarding technical matters, product configuration, verification that the product is defective, etc., to our Technical Support department nearest you or email tsupport@multitech.com. When calling the U.S., please direct your questions regarding repair expediting, receiving, shipping, billing, etc., to our Repair Accounting department at: +(763) 717-5631 in the U.S.A., or email mtsrepair@multitech.com.

Repairs for damages caused by lightning storms, water, power surges, incorrect installation, physical abuse, or user-caused damages are billed on a time-plus-materials basis.

7.2.3 Repair Procedures for International Distributors

Procedures for International Distributors of Multi-Tech products are on the distributor web site:
www.multitech.com

7.2.4 Replacement Parts

SupplyNet, Inc., can supply you with replacement power supplies, cables and connectors for selected Multi-Tech products. You can place an order with SupplyNet via mail, phone, fax or the Internet at the following addresses:

Mail: SupplyNet, Inc.
 614 Corporate Way
 Valley Cottage, NY 10989

Phone: 800 826-0279
 Fax: 914 267-2420
 Email: info@thesupplynet.com
 Internet: <http://www.thesupplynet.com>

7.3 Technical Support

Multi-Tech Systems has an excellent staff of technical support personnel available to help you get the most out of your Multi-Tech product. If you have any questions about the operation of this unit, please call 800 972-2439 (USA and Canada) or 763 785-3500 (international and local). Please have modem information available. You can also contact Technical Support by e-mail at the following addresses:

Country	Email	Telephone
U.S.A., Canada	tsupport@multitech.com	800 972-2439
France:	support@multitech.fr	+(33) 1-64 61 09 81
India:	support@multitechindia.com	+91 (124) 6340778
U.K.:	support@multitech.co.uk	+(44) 118 959 7774
Rest of world:	tsupport@multitech.com	+763 717-5863

Please note the status of the modem before contacting Technical Support. Status information can include the state of the LED indicators, screen messages, diagnostic test results, problems with a specific application, etc.

7.4 Internet Site

Multi-Tech is a commercial provider on the Internet. Multi-Tech has a Web site at: www.multitech.com.

Appendices

Appendix A

ASCII Conversion Chart

CTRL	CODE	HEX	DEC	CODE	HEX	DEC	CODE	HEX	DEC	CODE	HEX	DEC
@	NUL	00	0	SP	20	32	@	40	64	`	60	96
A	SOH	01	1	!	21	33	A	41	65	a	61	97
B	STX	02	2	"	22	34	B	42	66	b	62	98
C	ETX	03	3	#	23	35	C	43	67	c	63	99
D	EOT	04	4	\$	24	36	D	44	68	d	64	100
E	ENQ	05	5	%	25	37	E	45	69	e	65	101
F	ACK	06	6	&	26	38	F	46	70	f	66	102
G	BEL	07	7	'	27	39	G	47	71	g	67	103
H	BS	08	8	(28	40	H	48	72	h	68	104
I	HT	09	9)	29	41	I	49	73	i	69	105
J	LF	0A	10	*	2A	42	J	4A	74	j	6A	106
K	VT	0B	11	+	2B	43	K	4B	75	k	6B	107
L	FF	0C	12	,	2C	44	L	4C	76	l	6C	108
M	CR	0D	13	-	2D	45	M	4D	77	m	6D	109
N	SO	0E	14	.	2E	46	N	4E	78	n	6E	110
O	SI	0F	15	/	2F	47	O	4F	79	o	6F	111
P	DLE	10	16	0	30	48	P	50	80	p	70	112
Q	DC1	11	17	1	31	49	Q	51	81	q	71	113
R	DC2	12	18	2	32	50	R	52	82	r	72	114
S	DC3	13	19	3	33	51	S	53	83	s	73	115
T	DC4	14	20	4	34	52	T	54	84	t	74	116
U	NAK	15	21	5	35	53	U	55	85	u	75	117
V	SYN	16	22	6	36	54	V	56	86	v	76	118
W	ETB	17	23	7	37	55	W	57	87	w	77	119
X	CAN	18	24	8	38	56	X	58	88	x	78	120
Y	EM	19	25	9	39	57	Y	59	89	y	79	121
Z	SUB	1A	26	:	3A	58	Z	5A	90	z	7A	122
[ESC	1B	27	;	3B	59	[5B	91	{	7B	123
\	FS	1C	28	<	3C	60	\	5C	92		7C	124
]	GS	1D	29	=	3D	61]	5D	93	}	7D	125
^	RS	1E	30	>	3E	62	^	5E	94	~	7E	126
_	US	1F	31	?	3F	63	_	5F	95	DEL	7F	127

NUL	Null, or all zeros	VT	Vertical Tab	SYN	Sync.
SOH	Start of Header	FF	Form Feed	ETB	End Transmission Block
STX	Start of Text	CR	Carriage Return	CAN	Cancel
ETX	End of Text	SO	Shift Out	EM	End of Medium
EOT	End of Transmission	SI	Shift In	SUB	Substitute
ENQ	Enquiry	DLE	Data Link Escape	ESC	Escape
ACK	Acknowledge	DC1	Device Control 1	FS	File Separator
BEL	Bell or Alarm	DC2	Device Control 2	GS	Group Separator
BS	Backspace	DC3	Device Control 3	RS	Record Separator
HT	Horizontal Tab	DC4	Device Control 4	US	Unit Separator
LF	Line Feed	NAK	Negative Acknowledge	DEL	Delete

Appendix B

Dial Pulses

When you pulse dial, as when you make a call with a rotary dial telephone, your telephone or modem generates codes in the form of pulses that simulate the opening and closing of old-fashioned electric relays, or switches. The number of pulses in a code are the same as the digit they encode; thus, the digit *1* is represented by one pulse, the digit *2* by two pulses, etc. In Figure B-1, the digit *2* is pulse dialed, followed by the digit *1*. Each pulse consists of an *A* ms open (break) and a *B* ms closed (make), where *A* is either 60 or 67 ms, and *B* is either 40 or 33 ms, for a total of 100 ms per cycle, or a rate of 10 pulses per second. The interdigital pause time is 800 ms. The pulse ratios are controlled by the **&P** command.

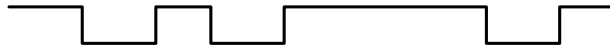

Figure B-1. Dial pulses

Tone Dial Frequencies

The tone dialing method combines two frequencies for each of the twelve digits found on a touch-tone dial pad. This method is referred to as dual-tone multi-frequency (DTMF) dialing.

The four horizontal rows on a touch-tone keypad use four low-frequency tones (697, 770, 852, 941 Hz), while the three vertical columns use three high-frequency tones (1209, 1336, 1477 Hz). The tone frequency tolerance is $\pm 0.02\%$.

For example, the digit 4 is dialed by combining two tone frequencies: 770 Hz from the second row, and 1209 Hz from the first column. In another example, the digit 9 is dialed with tone frequencies 852 Hz and 1477 Hz.

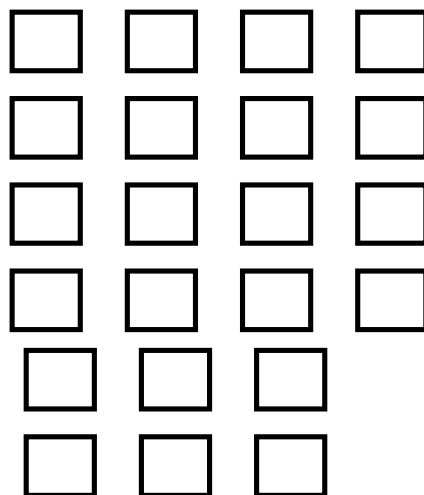
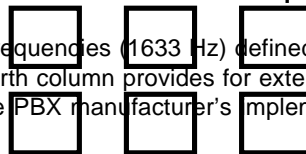

Figure B-2. Standard DTMF frequencies

Figure B-3. Extended DTMF frequencies

The extended DTMF characters (A, B, C, D) are the high-end frequencies (1633 Hz) defined on some telephone sets with a fourth vertical column of buttons. This fourth column provides for extended PBX control functions. The actual functions that are provided depend on the PBX manufacturer's implementation and feature set.



Appendix C

Result Code Summary

Multi-Tech Result Codes (&Q0)

<i>Terse</i>	<i>Verbose</i>	<i>Definition</i>
0	OK	Command was executed without error; ready for next command.
1	CONNECT	Modem has detected carrier and gone online.
2	RING	Modem has detected ring caused by incoming call.
3	NO CARRIER	No carrier signal has been detected within the allowed time.
4	ERROR	Error in command line (too many, or invalid characters).
5	CONNECT 1200	Modem has detected carrier at 1200 bps and gone online.
6	NO DIALTONE	No dial tone has been detected.
7	BUSY	A busy signal has been detected.
8	NO ANSWER	The remote system did not answer.
9	CONNECT 2400	Modem has detected carrier at 2400 bps and gone online.
10		Not used.
11	CONNECT 4800	Modem has detected carrier at 4800 bps and gone online.
12	CONNECT 9600	Modem has detected carrier at 9600 bps and gone online.
13	CONNECT 14400	Modem has detected carrier at 14400 bps and gone online.
19	CONNECT 19200	Modem has detected carrier at 19200 bps and gone online.
21	CONNECT 21600	Modem has detected carrier at 21600 bps and gone online.
23	CONNECT 1275	Modem is connected in V.23 mode.
24	CONNECT 24000	Modem has detected carrier at 24000 bps and gone online.
26	CONNECT 26400	Modem has detected carrier at 26400 bps and gone online.
28	CONNECT 28800	Modem has detected carrier at 28800 bps and gone online.
31	CONNECT 31200	Modem has detected carrier at 31200 bps and gone online.
33	CONNECT 33600	Modem has detected carrier at 33600 bps and gone online.

MNP Reliable Mode. If the modem connects using MNP error correction, the word *RELIABLE* or the letter *R* is added to the *CONNECT* responses as follows:

1R	CONNECT RELIABLE
5R	CONNECT 1200 RELIABLE
9R	CONNECT 2400 RELIABLE
11R	CONNECT 4800 RELIABLE
12R	CONNECT 9600 RELIABLE
13R	CONNECT 14400 RELIABLE
19R	CONNECT 19200 RELIABLE
21R	CONNECT 21600 RELIABLE
24R	CONNECT 24000 RELIABLE
26R	CONNECT 26400 RELIABLE
28R	CONNECT 28800 RELIABLE
31R	CONNECT 31200 RELIABLE
33R	CONNECT 33600 RELIABLE

LAP-M Reliable Mode. If the modem connects using LAP-M error correction, the word *LAPM* or letter *L* is added to the *CONNECT* responses as follows:

1L *CONNECT LAPM*
5L *CONNECT 1200 LAPM*
9L *CONNECT 2400 LAPM*
10L *CONNECT 4800 LAPM*
12L *CONNECT 9600 LAPM*
13L *CONNECT 14400 LAPM*
19L *CONNECT 19200 LAPM*
21L *CONNECT 21600 LAPM*
24L *CONNECT 24000 LAPM*
26L *CONNECT 26400 LAPM*
28L *CONNECT 28800 LAPM*
31L *CONNECT 31200 LAPM*
33L *CONNECT 33600 LAPM*

Data Compression. If the modem connects using data compression, the word *COMPRESSED* or the letter *C* is added to the *CONNECT* responses.

Standard AT Result Codes (&Q1)

If standard AT command set responses are selected by the **&Q** command, the following result codes change:

9		Not used.
10	<i>CONNECT 2400</i>	Modem has detected carrier at 2400 bps and gone online.

Appendix D

S-Register Summary

Register	Unit	Range	Default	Description
S0	1 ring	0, 1–255	1	Sets the number of rings until the modem answers. ATS0=0 disables auto answer completely.
S1	1 ring	0–255	0	Counts the rings that have occurred.
S2	decimal	0–127	43 (+)	Sets ASCII code for the escape code character.
S3	decimal	0–127	13 (^M)	Sets ASCII code for the RETURN character.
S4	decimal	0–127	10 (^J)	Sets ASCII code for the LINE FEED character.
S5	decimal	0–127	8 (^H)	Sets ASCII code for the BACKSPACE character.
S6	1 sec	2–255 4–255† 4–7‡	2 4† 4‡	Time the modem waits for a dial tone before aborting a call.
S7	1 sec	1–255 1–45* 1–55‡	45 45* 55‡	Time the modem waits for a carrier signal before aborting a call.
S8	1 sec	0–255 4–255† 4–7‡	2 4† 4‡	Length of the pause by a comma character in a dialing command.
S9	100 ms	1–255	6	Sets delay between when the modem detects a valid carrier signal and when it turns on its CD circuit.
S10	100 ms	1–254, 255	7	Sets how long a carrier signal must be lost before the modem disconnects. S10=255 causes the modem to not disconnect with loss of carrier.
S11	1 ms	1–255 80–255* 80–255‡	70 80* 80‡	Sets spacing and duration of dialing tones. 50 ms is the recommended minimum.
S13	decimal	0, 1–127	37 (%)	Sets ASCII code for remote configuration escape character. S13=0 disables remote configuration.
S17	10 ms	1–255	25	Sets the length of the break time (space) sent to the local PC when the modem receives a remote break.
S24	50 ms	0–255	20	Sets the time the DSR, CTS, and CD signals drop before going high again. Used for some PBX and CBX phone systems.
S25	100 ms	0, 1–255	0	Sets the time the DTR signal must be dropped before the modem dis-connects. The 0 default equals 50 ms.
S30	1 min.	0, 1–255	0	Sets how long the modem waits after the last character is received or transmitted before it disconnects. The 0 default disables the timer.
S32	100 ms	0–255	20	Sets the time the modem will wait for a RETURN to be entered during escape sequence execution.

S34	1 character	0–60	10	Sets the number of command characters allowed after +++AT .
S36	1 sec	0, 1-255	5	Sets the time between DTR inactive and modem off-hook. S36=0 disables DTR busy-out.
S37	1 sec	0-255	5	Sets the time between DTR active and modem on-hook.
S43	decimal	33, 31, 28, 26, 24, 21, 19, 16, 14, 12, 96, or 48	0	Sets fixed V.34 connect speed. 28 = 28800 bps; 26 = 26400 bps; . . . 48 = 4800 bps. 0 default disables this feature.
S48	decimal	33, 31, 28, 26, 24, 21, 19, 16, 14, 12, 96, or 48	0	Sets maximum V.34 connect speed. 33 = 33600 bps; 31 = 31200 bps; . . . 48 = 4800 bps. 0 default disables feature (same as S48=33).
S94	1 sec	0–254, 255	45	Sets the maximum time the modem remains out of service when *H1 is active. S94=255 causes the modem to remain out of service indefinitely, until it receives an enable from the management software.

Appendix E

AT Command Summary

Command	Values	Description
AT	n/a	Attention Code The attention code precedes all command lines except A/ , A: and escape codes.
RETURN	n/a	RETURN Key Press the RETURN (ENTER) key to execute most commands.
A	n/a	Force Answer Mode Answer call immediately without waiting for ring.
A/	n/a	Repeat Last Command Do not precede this command with AT. Do not press RETURN to execute.
A:	n/a	Continuous Redial Continuous redial of last number until answered. (10 redials in North American models. Not used on International or U.K. models.)
&An	n = 0 or 1	Answerback *** &A0 Answerback off. &A1 Answerback on.
\$An	n = 0 or 1	Auto-Reliable Buffering *** \$A0 Discard data received during establishment of reliable connection \$A1 Buffer data received during establishment of reliable connection
#An	n = 0–3	Auto Speed Detection in Answer Mode *** #A0 Start at maximum speed and fall back to 14400 to 12000 to 9600 to 4800 to 2400 to 1200 to 300 bps. #A1 Maximum speed only. #A2 Start at maximum speed and fall back incrementally to 4800 bps only. #A3 Start at 2400 bps and fall back to 1200 to 300 bps only.
Bn	n = 0 or 1	Answer Tone (International models only) *** B0 Select ITU-T V.21 answer tone. B1 Select Bell 103 answer tone.
&BSn	n = 0 or 1	Maximum Reliable Block Size *** &BS0 Maximum transmit block size of 64 characters. &BS1 Maximum transmit block size of 256 characters.
\$BAn	n = 0 or 1	Baud Adjust *** \$BA0 Set baud adjust off, speed conversion on. (Serial port speed is independent of modem data rate.) \$BA1 Set baud adjust on, speed conversion off. (Serial port speed is same as modem data rate.)
&Cn	n = 0, 1, 2, or 4	Carrier Detect Control *** &C0 Force Carrier Detect on. &C1 Let Carrier Detect follow carrier signal. &C2 Let Carrier Detect drop for time set by S24 on disconnect, then go high again. &C4 Reset modem when Carrier Detect drops.

&CDn	<i>n</i> = 0 or 1	<p>Cleardown at Disconnect</p> <p>*** &CD0 Enable cleardown. &CD1 Disable cleardown.</p>
Ds	<i>s</i> = phone #	<p>Dial</p> <p>Dial telephone number <i>s</i>, where <i>s</i> may include up to 60 digits or T, P, R, comma, colon, and semicolon characters.</p>
DsNd	<i>s</i> = phone # <i>d</i> = 0 or 1	<p>Store Phone Number</p> <p>To store, enter D followed by telephone number <i>s</i>, then N followed by directory number <i>d</i>.</p>
&Dn	<i>n</i> = 0, 1, 2, or 3	<p>Data Terminal Ready Control</p> <p>&D0 Modem ignores DTR signal. &D1 When DTR drops, the modem hangs up. While DTR is low, the modem accepts commands but will not dial or auto-answer until DTR goes high again.</p> <p>*** &D2 Same as &D1. &D3 When DTR drops, the modem hangs up and resets as if an ATZ or an AT&F command was issued.</p>
%DCn	<i>n</i> = 0 or 1	<p>Command Mode Control</p> <p>*** %DC0 Enable command mode. %DC1 Disable command mode.</p>
%DFn	<i>n</i> = 0 or 1	<p>Line Probe Data Format</p> <p>*** %DF0 V.34 line probe data displayed in graph format. %DF1 V.34 line probe data displayed in table format.</p>
%DPn	<i>n</i> = 0 or 1	<p>Line Probe Data Read</p> <p>*** %DP0 Disable reading of line probe data during the V.34 handshake. %DP1 Enable reading of line probe data during the V.34 handshake.</p>
>DTn	<i>n</i> = 0 or 1	<p>DTMF Detection</p> <p>*** >DT0 Disable DTMF detection. >DT1 Enable DTMF detection when off-hook.</p>
En	<i>n</i> = 0 or 1	<p>Echo Command Mode Characters</p> <p>E0 Do not echo command mode characters. *** E1 Do echo command mode characters.</p>

&En	$n = 0-15$	<p>V.42 Error Correction Modes</p> <p>&E0 Non-error correction mode (V.42 disabled).</p> <p>*** &E1 Auto-reliable mode.</p> <p>&E2 Reliable mode (V.42 enabled).</p> <p>Modem-Initiated Flow Control</p> <p>&E3 Flow control disabled.</p> <p>*** &E4 Hardware flow control.</p> <p>&E5 XON/XOFF flow control.</p> <p>XON/XOFF Pass-Through (&E5 selected)</p> <p>*** &E6 XON/XOFF not passed through.</p> <p>&E7 XON/XOFF passed through.</p> <p>Hewlett-Packard ENQ/ACK Pacing</p> <p>*** &E8 ENQ/ACK pacing off.</p> <p>&E9 ENQ/ACK pacing on.</p> <p>Non-Error Correction Mode Flow Control</p> <p>*** &E10 Non-error correction mode flow control off.</p> <p>&E11 Non-error correction mode flow control on.</p> <p>Pacing (Computer-Initiated Flow Control)</p> <p>&E12 Pacing off.</p> <p>*** &E13 Pacing on.</p> <p>Data Compression</p> <p>&E14 Data compression disabled.</p> <p>*** &E15 Data compression enabled.</p>
\$En	$n = 0$ or 1	<p>V.42 Error Correction at 300 bps</p> <p>*** \$E0 V.42 error correction at 300 bps disabled.</p> <p>\$E1 V.42 error correction at 300 bps enabled.</p>
\$EBn	$n = 0$ or 1	<p>Asynchronous Word Length</p> <p>*** \$EB0 10-bit mode enabled.</p> <p>\$EB1 11-bit mode enabled.</p>
%En	$n = 0-5$	<p>Escape Sequence Options</p> <p>%E0 Modem won't escape.</p> <p>*** %E1 +++ method.</p> <p>%E2 Break method.</p> <p>%E3 Either +++ or break methods.</p> <p>*** %E4 No OK response to +++.</p> <p>%E5 OK response to +++.</p>
&Fn	$n = 0, 8,$ or 9	<p>Load Default Configuration</p> <p>&F0 Load factory default values from ROM.</p> <p>*** &F8 Read factory default values and DIP switch settings when &F is issued.</p> <p>&F9 Read parameters stored in nonvolatile memory when &F is issued.</p>
\$Fn	$n = 0$ or 1	<p>Auto-Reliable Fallback Character Enable</p> <p>*** \$F0 Do not fall back to non-error correction mode connect if CR received.</p> <p>\$F1 Fall back to non-error correction mode connect if CR received.</p>
%Fn	$n = 0$ or 1	<p>Echo Canceler Offset Frequency Compensation</p> <p>*** %F0 Disable echo canceler offset frequency compensation.</p> <p>%F1 Enable echo canceler offset frequency compensation.</p>

#Fn	<i>n</i> = 0, 1, or 2	Fallback Modes When Online #F0 No fallback when online. #F1 Fall back incrementally from maximum speed to 4800 bps. *** #F2 Fall back incrementally to 4800 bps, fall forward when line improves.
&Gn	<i>n</i> = 0, 1, or 2	Guard Tones (International model only) *** &G0 Turn off ITU-T guard tones. &G1 Turn on ITU-T 550 Hz guard tone. &G2 Turn on ITU-T 1800 Hz guard tone. Note: The U.K. model is locked to &G2 , which turns on the ITU-T 1800 Hz guard tone.
Hn	<i>n</i> = 0 or 1	On-Hook/Off-Hook H0 Go on-hook (hang up). H1 Go off-hook.
*Hn	<i>n</i> = 0 or 1	Busy-Out After Disconnect *** *H0 Disable busy-out after disconnect. *H1 Enable busy-out after disconnect.
In	<i>n</i> = 0, 1, 2, or 5	Inquire Product Codes I0 Request modem ID #. I1 Request firmware revision #. I2 Request modem description. I5 Request DSP version.
#Ix	<i>x</i> = password	Enter Login Password Password is case sensitive.
#I=x	<i>x</i> = password	Store Login Password Password must be 6–10 characters long, and may consist of any keyboard characters.
Ln	<i>n</i> = 0, 5–11	List Commands L List stored telephone numbers. L5 List current operating parameters. L6 List current S-register values. L7 List additional parameters. L8 List online diagnostic parameters. L9 List line probe signal strength data. L10 List line probe signal to noise ratio. L11 List line probe noise data. Note: To use L9 , L10 , or L11 when online, you must first escape to command mode by typing +++ATLn<CR> (for n type 9 , 10 , or 11). Type ATO to return on line.
#Ln	<i>n</i> = 0, 1, 2, 3, or 8	V.42 Error Correction Mode *** #L0 Modems negotiate V.42 mode. #L1 MNP on and LAP-M off (originate mode only). #L2 LAP-M on and MNP off (originate mode only). #L3 Disable detection phase and go directly to LAP-M.
Mn	<i>n</i> = 0, 1, 2, or 3	Modem Speaker Control M0 Modem speaker always off. *** M1 Modem speaker on until carrier signal detected. M2 Modem speaker always on. M3 Monitor speaker on during dialing, off during handshaking.

\$MBn	<i>n</i> = speed	Modem Baud Rate \$MB75 Select ITU-T V.23 mode. \$MB300 Select 300 bps on line. \$MB1200 Select 1200 bps on line. \$MB2400 Select 2400 bps on line. \$MB4800 Select 4800 bps on line. \$MB7200 Select 7200 bps on line. \$MB9600 Select 9600 bps on line. \$MB12000 Select 12,000 bps on line. \$MB14400 Select 14,400 bps on line. \$MB16800 Select 16,800 bps on line. \$MB19200 Select 19,200 bps on line. \$MB28800 Select 28,800 bps on line. *** \$MB33600 Select 33,600 bps on line.
Nd	<i>d</i> = 0 or 1	Dial a Stored Number Dial stored telephone number <i>d</i> .
NdNe...	<i>d</i> = 0 or 1 <i>e</i> = 1 or 0	Number Linking Dial stored number <i>d</i> ; if that is busy, dial stored number <i>e</i> . The command may be extended NdNeNdNe... to cycle between the two numbers.
O	n/a	Go Back On Line Exit command mode and go into online mode after using the escape code to do the reverse.
P	In dialing command	*** Pulse-Dial Modem pulse-dials numbers that follow P.
&Pn	<i>n</i> = 0 or 1	Set Pulse Dial Ratios *** &P0 60:40 pulse ratio. &P1 67:33 pulse ratio. Note:The ZDXK is locked to &P1, a 67:33 ratio.
Qn	<i>n</i> = 0–2	Result Codes Enable/Disable *** Q0 Result codes sent. Q1 Result codes suppressed (quiet). Q2 No Response answer mode.
&Qn	<i>n</i> = 0 or 1	Result Codes (Multi-Tech or Standard AT) *** &Q0 Multi-Tech responses with modifiers. &Q1 Standard AT responses with no modifiers.
Rn	<i>n</i> = 0 or 1	Reverse Originate/Answer Mode *** R0 Modem will not reverse modes. R1 Modem will reverse modes when R is added to dial string.
&Rn	<i>n</i> = 0, 1, or 2	Clear to Send Control &R0 Let CTS state follow RTS state when online. *** &R1 Force CTS high (on). &R2 Let CTS drop on disconnect for time set by S24, then go high again.
&RAn	<i>n</i> = 0 or 1	Asymmetric Bit Rate *** &RA0 Enable asymmetric bit rate operation. &RA1 Disable asymmetric bit rate operation.
&RDn	<i>n</i> = 0 or 1	Square Wave Ring Detect &RD0 Full wave ring detect only. *** &RD1 Full wave and square wave ring detect.

&RFn	$n = 0$ or 1	CTS/RTS Interaction Control &RF0 Let CTS follow RTS. *** &RF1 Let CTS act independently.
&RN	n/a	Rate Renegotiation Forces the modem to renegotiate the data rate.
&RP	n/a	Immediate Line Probe Initiates a retrain that makes the modem read line probe information if %DP1 is selected. Valid only when online in V.34 mode.
&RR	n/a	Retrain Initiates an immediate retrain without a line probe reading.
\$Rn	$n = 0$ or 1	Retransmit Count *** \$R0 Disconnect after 12 retransmits. \$R1 Do not disconnect after 12 retransmits.
Sr=n	$r = 0-11, 13, 24, 25, 30, 32, 34, 36, 37, 43, 48,$ or $94; n$ varies	Set Register Value Set value of S-register r to value of n , where n is entered in decimal format.
Sr?	$r = 0-11, 13, 24, 25, 30, 32, 34, 36, 37, 43, 48,$ or 94	Read Register Value Read value of S-register r and display value in 3-digit decimal form.
&Sn	$n = 0, 1,$ or 2	Data Set Ready Control &S0 Force DSR high (on). *** &S1 Let DSR follow CD. &S2 DSR drops on disconnect for time set by S24 , then goes high again.
&SFn	$n = 0$ or 1	DSR/CD Interaction Control *** &SF0 Select DSR to follow CD. &SF1 Select DSR to be independent.
\$SBn	$n =$ speed Baud Adjust (\$BA) must be off.	Serial Port Baud Rate \$SB300 Select 300 bps at serial port. \$SB1200 Select 1200 bps at serial port. \$SB2400 Select 2400 bps at serial port. \$SB4800 Select 4800 bps at serial port. \$SB9600 Select 9600 bps at serial port. \$SB12000 Select 12,000 bps at serial port. \$SB19200 Select 19,200 bps at serial port. \$SB38400 Select 38,400 bps at serial port. \$SB57600 Select 57,600 bps at serial port. *** \$SB115200 Select 115,200 bps at serial port.
#Sy	$y =$ password	Enter Setup Password Password is case sensitive.
#S=y	$y =$ password	Store Setup Password Password must be 6–10 characters long, and may consist of any keyboard characters.
T	In dialing command	Tone-Dial Modem tone-dials numbers following the T.

&Tn	<i>n</i> = 4 or 5	Respond to Remote Digital Loopback Signal &T4 Enable response to remote digital loopback signal. *** &T5 Disable response to remote digital loopback signal.
\$Tn	<i>n</i> = 0 or 1	Calling Tone \$T0 Enable calling tone. *** \$T1 Disable calling tone.
#Tn	<i>n</i> = 0 or 1	Trellis-Coded Modulation #T0 Disable trellis-coded modulation. *** #T1 Enable trellis-coded modulation.
Un	<i>n</i> = 0–3	Loopback Test Modes U0 Enable analog loop originate mode. U1 Enable analog loop answer mode. U2 Enable remote digital loopback mode. U3 Enable local digital loopback mode.
Vn	<i>n</i> = 0 or 1	Result Codes (Verbose/Terse) V0 Result codes sent as digits (terse response). *** V1 Result codes sent as words (verbose response).
#Vn	<i>n</i> = 0 or 1	V.32terbo Handshake *** #V0 Enable V.32terbo tones in answer mode. #V1 Disable V.32terbo tones in answer mode.
W	In dialing command	Wait for New Dial Tone Causes modem to wait for new dial tone. (X2 or X4 must be selected.)
&Wn	<i>n</i> = 0 or 1	Store Configuration &W0 Store current settings in NVRAM; modem will load these at power-on or with the ATZ command instead of reading factory ROM defaults. *** &W1 Do not store settings.
Xn	<i>n</i> = 0–4	Result Codes and Call Progress Selection *** X0 Basic result codes (<i>CONNECT</i> only); does not look for dial tone or busy. X1 Extended result codes (w/ <i>CONNECT 1200</i> , <i>CONNECT 2400</i> , etc.); does not look for dial tone or busy signal. X2 Extended result codes with <i>NO DIAL TONE</i> ; does not look for busy signal. X3 Extended result codes with <i>BUSY</i> ; does not look for dial tone. X4 Extended result codes with <i>NO DIAL TONE</i> and <i>BUSY</i> .
#Xn	<i>n</i> = 0 or 1	Number of XOFF Characters Sent *** #X0 Single XOFF character sent after buffer is full. #X1 Multiple XOFF characters sent (one for every character received after buffer is full).
Yn	<i>n</i> = 0 or 1	Long Space Disconnect *** Y0 Disable sending or responding to long space break signal on disconnect. Y1 Enable sending or responding to long space break signal on disconnect. (Both modems must have Y1 set.)
Z	n/a	Modem Reset Reset modem to default values. Defaults come from NVRAM if &W0 is set, from ROM if &W1 is set.
,	In dial command	Dialing Pause Comma; causes dialing pause for time set by S8 .

:	At end of dial command	Continuous Redial Colon; causes continuous redial of number until answered (10 in North American models). Not used in U.K. or International models.
;	At end of dial command	Return to Command Mode After Dialing Semi-colon; causes immediate return to command mode after dialing.
!	In dial command	Flash On-Hook Exclamation; causes modem to flash on-hook.
@	In dial command	Quiet Answer Causes modem to wait for a ringback, then 5 seconds of silence before processing next part of command.
\$	In dial command	Call Card Tone Detect Causes modem to wait for a call card tone before processing next part of command.
+++AT<CR>		Escape Sequence Puts modem in command mode while still remaining on line. Type +++ followed by the letters A and T , up to ten command characters (or as defined by S34), and a RETURN.
<BREAK>AT<CR>		Break Escape Sequence Alternate escape method. Puts modem in command mode while still remaining on line. Enter break signal followed by the letters A and T , up to sixty command characters, and a RETURN.
%%%AT<CR>		Remote Configuration Escape Sequence Cause remote modem to display remote configuration menu. Type %%% (or as defined in register S13) followed by the letters A and T , and a RETURN.

Appendix F

RS-232C Interface Specifications

The MT2834MR6's serial interface circuits have been designed to meet the electrical specifications in EIA (Electronic Industries Association) Recommended Standard 232, Revision C (RS-232C). All signals generated by the modem are approximately 10 volts when measured across a load of 3000 ohms or greater. The receiving circuits of the modem accept signals in the 3 to 25 volt range. The voltage thresholds are defined as follows:

Negative: voltage more negative than 3 volts with respect to signal ground

Positive: voltage more positive than +3 volts with respect to signal ground

Signal Information	Negative	Positive
Binary State	One	Zero
Signal Condition	Mark	Space
Control and Timing Function	Off	On

The input impedances of all modem circuits that accept signals from the data processing terminal or CPU equipment are 4.7KW. For more specific details, consult the EIA RS-232C standard. The following chart lists the EIA RS-232C interface pins and circuits present on the MT2834MR6's RS-232C serial interface connector. All other pins are unused.

Pin Assignment	Multi-Tech Designation	EIA Circuit	Signal Source*	Circuit Function
1	PG	—	—	Protective Ground
2	TD	BA	DTE	Transmitted Data
3	RD	BB	DCE	Received Data
4	RTS	CA	DTE	Request to Send
5	CTS	CB	DCE	Clear to Send
6	DSR	CC	DCE	Data Set Ready
7	SG	AB	—	Signal Ground
8	CD	CF	DCE	Data Carrier Detector
9	+V	+V	DCE	Test Voltage
12	HS	--	DCE	High Speed
15	TC	DB	DCE	Transmit Clock
17	RC	DD	DCE	Receive Clock
20	TR	CD	DTE	Data Terminal Ready
22	RI	CE	DCE	Ring Indicator
24	XTC	DA	DTE	External Transmit Clock
25	OOS	CN	DTE	Terminal Busy

* DTE = Data Terminal Equipment (terminal or computer)

DCE = Data Communications Equipment (the modem)

The computer or terminal should be supplied with a cable terminated with a Cinch DB25P or equivalent connector mounted in a Cinch DB51226-1 or equivalent hood assembly as specified by the EIA RS-232C standard.

Functional Description of the RS-232C Signals

Transmitted Data (TD) — Pin 2 (To modem)

Signals on this circuit are generated by the local computer and passed to the modem's transmitter. A positive signal is a space (binary 0) and a negative signal is a mark (binary 1). The transmitting computer should hold this line in the marking state when no data is being transmitted, including intervals between characters or words. The TD LED indicates the status of this circuit.

Received Data (RD) — Pin 3 (From modem)

The circuit is the data output of the modem. Data signals received from the remote modem are passed to the local computer on this line. When no carrier signal is being received (pin 8 negative), this line is forced into a marking condition. The RD LED indicates the status of this signal.

Request To Send (RTS) — Pin 4 (To modem)

This signal, from the computer, indicates to the modem that the computer has data to transmit.

Clear To Send (CTS) — Pin 5 (From modem)

This signal indicates to the computer that the modem is ready to transmit any data present on the Transmit Data line (pin 2).

Data Set Ready (DSR) — Pin 6 (From modem)

This signal indicates that the modem is in data mode and is connected to the communications channel. This signal is on during analog-loop-test mode.

Signal Ground (SG) — Pin 7

The SG pin is connected to the modem's signal ground. It establishes the common ground reference for all the other interface signals.

Carrier Detect (CD) — Pin 8 (From modem)

A high CD signal (positive voltage) indicates that a carrier signal has been received from the other modem. This circuit does not typically turn on in the presence of message circuit noise or out-of-band signals. There is a one-second delay between when the carrier tone is detected and when the CD circuit is turned on.

This signal goes off if received data carrier falls below the receiver threshold for more than 37 ms. When CD is off, the Received Data circuit (pin 3) is held to the marking state.

Test Voltage (+V) — Pin 9 (From modem)

This test pin has 330 ohms of resistance to +12 volts DC. It can be used to strap other signals high. For example, if the terminal does not supply a DTR (Data Terminal Ready) signal, pin 9 can be jumpered to pin 20 (DTR) on the RS-232C connector or cable to force DTR on.

High Speed (HS) — Pin 12 (From modem)

The high state of this circuit indicates that the modem is in the high speed (1200 bps) mode. This circuit is commonly used to signal the computer or terminal to which the modem is connected to switch to its 1200 bps setting.

Transmit Clock (TC) — Pin 15 (From modem)

The TC signal does not apply to the MT2834MR6, since it is used only in the synchronous mode. The clock is a square wave and is used to provide the computer or terminal with timing information for its Transmit Data circuit (pin 2). This clock is provided on the interface at all times when the modem is in synchronous mode.

The first signal element of the Transmitted Data signal should be presented by the terminal on the first positive (off to on) transition of TC after the CTS circuit on pin 5 is turned on. The transmitted data is sampled by the modem on negative transitions of TC.

Receive Clock (RC) — Pin 17 (From modem)

The RC signal has the same characteristics as the TC signal, with the exception that it is used to provide the computer or terminal with timing information for its Receive Data (pin 3) circuit. The RC signal's negative transition (on to off) indicates the center of each signal element on the Received Data circuit.

Data Terminal Ready (DTR) — Pin 20 (To modem)

The DTR signal provides a means for the computer to control the modem's connection to the communications channel. A high DTR signal is required by the modem to be able to communicate. Turning DTR off for more than 50 ms forces the modem to disconnect.

The most common use of DTR is in autoanswer applications. A frequently used method is to have the computer turn on DTR in response to RI (Ring Indicator), which allows the modem to answer. Later, DTR is turned off at the conclusion of the log off procedure, which forces the modem to disconnect, enabling it to receive another call. In non-autoanswer applications it is advisable to leave DTR on. This is the standard factory setting. An alternative is to provide a constant high DTR from the terminal or computer.

Ring Indicator (RI) — Pin 22 (From modem)

This signal remains on for the duration of the ringing signal. When a ring signal is received by the modem, the modem automatically answers after the first ring. The modem can answer after a specified number of rings which can be programmed in command mode, but if none is specified, the modem answers after the first ring.

External Transmit Clock (XTC) — Pin 24 (To modem)

Supplies the same function as the Transmit Clock signal on pin 15.

Terminal Busy (OOS) — Pin 25 (To modem)

The Terminal Busy/Out of Service (OOS) circuit is not defined in the RS-232C standard, but is used by Multi-Tech Systems and most manufacturers to make the phone lines busy to incoming phone calls. Pin 25 is not typically connected to the RS-232C interface when shipped from the factory; it can be ordered connected as an option. If pin 25 is connected and is brought high, the modem is placed off hook, and is busy to incoming calls.

Appendix G

Cable and Connector Diagrams

RS-232C Serial Cable

1	1	Frame Ground	1
2	2	Transmit Data	2
3	3	Receive Data	3
4	4	Request to Send	4
5	5	Clear to Send	5
6	6	Data Set Ready	6
7	7	Signal Ground	7
8	8	Carrier Detect	8
9	9	+ Voltage Test	9
12	12	High Speed	12
15	15	Transmit Clock	15
17	17	Receive Clock	17
20	20	Data Terminal Ready	20
22	22	Ring Indicator	22
25	25	Terminal Busy	25

25-pin male connector (DB-25P)

25-pin female connector (DB-25S) on back of rack

Connects to terminal or computer RS-232C interface (serial port). Gender and pin-out depends on device.

APPENDIX H

Introduction to MultiTech Escape Methods

You may sometimes find it necessary to issue AT commands to your modem, while you are online with a remote modem, without disconnecting the call. If so, you will want to take advantage of escape methods that allow you to change the modem's mode of operation from online mode to command mode. After you issue your AT commands, you may return to online mode, but typically most users escape so that they can hang up a modem upon completion of a call.

Our modems offer two escape methods: in-band and out-of-band. Both incorporate Time Independent Escape Sequence (TIES) methodology. An escape sequence is a pattern or sequence that the modem recognizes as its signal to shift from online mode to command mode. "Time independent" means that the modem recognizes the escape sequence without a prefixed and/or suffixed delay.

In an in-band escape, the modem recognizes the escape sequence as a pattern sent to it as part of the data stream or band (hence its name).

In an out-of-band escape, the escape sequence is a pattern that cannot and does not occur in the data stream.

Our in-band escape method is **+++AT<CR>**

Our out-of-band escape method is **<BREAK>AT<CR>**

A break signal cannot be sent as part of a data file; instead it is sent by a direct program command to the UART used by the computer.

The break signal is defined as either the transmission of binary 0 for a minimum of 10 bits; or as a minimum interval of 135 milliseconds as established in the ITU-T X.28 standard. Routines in high level languages, and keys on most computers, can send the break signal for fixed intervals.

How to Select an Escape Method

If you want your modem to escape and then wait for you to issue a command before it will return to online mode, then use **+++AT<CR>**. For example, use this method if you find you need to review a help screen in the middle of a communications session.

If you wish to combine the escape with a command (or commands) and with an immediate return to online mode, then use the **<BREAK>AT<CR>** method. You may also use this method to have the modem wait before it will return on line.

The following AT commands are used to select the modem's escape method:

%E0 Escape disabled	%E3 Both methods enabled
%E1 +++AT method	%E4 Disable OK to +++ escape
%E2 BREAK AT method	%E5 Enable OK to +++ escape

Escape Method 1: +++AT<CR>

In the following example, a user who is in online mode decides to set **S0** to 1 to configure the modem to answer on the first ring.

1. The user types the sequence **+++AT<CR>**. The sequence is sent to the modem.
2. The modem transmits the **+++**.
3. The modem buffers **AT** and starts the wait-for-<CR> timer.
4. Upon receiving the **<CR>** the modem escapes to command mode.
5. The modem responds *OK*.
6. The user enters the command **ATS0=1<CR>**. This sequence is sent to the modem.
7. The modem buffers **ATS0=1<CR>** and identifies it as a valid command.
8. The modem executes the command, setting the contents of **S0** to 001.
9. The user sends **ATO<CR>** to the modem.
10. The modem returns to online mode.

Escape Method 2: <BREAK>AT<CR>

In the following example, a user who is in online mode decides to set **S0** to 1, to configure the modem to answer on the first ring.

1. The break signal is sent to the modem.
2. The modem buffers the break signal.
3. The modem starts the **S32** wait-for-<CR> timer.
4. **ATS0=1<CR>** is sent to the modem.
5. The modem buffers **ATS0=1<CR>** and identifies it as a valid command.
6. The modem escapes to command mode.
7. The modem executes the command, setting the contents of **S0** to 001.
8. The modem returns to online mode.

S-Registers and Escape Sequence

There are two S-registers to modify the functioning of escape sequences. Register **S32** establishes a value for how much time may elapse between the receipt of the beginning of the escape sequence, whether **<BREAK> AT** or **+++AT**, and the receipt of a **<CR>**. This interval is known as wait-for-**<CR>**-time, or break passthrough.

Assign a value in increments of 100 milliseconds to **S32**. The default value is 20, or 2 seconds. In the **+++AT<CR>** method, the wait-for-**<CR>**-time interval begins once the **A** in **+++AT** is received by the modem. In the **<BREAK> AT** method, the wait-for-**<CR>**-time interval begins once the modem has received the break signal.

Register **S34** is used in conjunction with in-band escape sequence, **+++AT<CR>**, to establish the maximum number of characters the modem can buffer following an **AT**, before a **<CR>** must be received. The default value is 10 characters. Do not confuse this buffer size with the regular command mode buffer length of 60 characters.

Register **S34** does not affect our out-of-band escape sequence's buffer length, which is fixed at 60 characters.

Aborting an Escape Sequence

The **+++AT<CR>** escape will abort if you do not issue a **<CR>** before the wait-for-**<CR>**-time interval expires.

The **<BREAK>AT<CR>** method will also abort if you do not issue a **<CR>** before the wait-for-**<CR>**-time interval expires, and also if any of the following occurs:

1. An illegal sequence is detected, including:
 - a) A character other than **A** follows **<BREAK>**;
 - b) A character other than **T** follows **<BREAK>A**;
 - c) Two **<BREAK>**s are received in succession.
2. The command buffer overflows before a **<CR>** occurs.

If you have any questions regarding the information in this appendix, please contact Technical Support (see Chapter 7).

APPENDIX I

Introduction to Remote Configuration

Remote configuration, a feature of Multi-Tech's MT2834MR6 modems, is a network management tool that allows you to configure modems anywhere in your network from one location. With password-protected remote configuration, you can issue AT commands to a remote Multi-Tech modem for maintenance or troubleshooting as if you were on site.

Basic Procedure

The following steps are valid regardless of whether the connection is established by the local or the remote Multi-Tech modem.

1. Establish a data connection with a remote modem that has the remote configuration feature.
2. Send three remote configuration escape characters followed by **AT** and an ENTER. Example: **%%%AT<CR>**. The remote modem responds with the following menu:
 1. *DATA Mode*
 2. *COMMAND Mode*
3. Enter the number **2**. The remote modem responds with a request for the setup password:
Password>
4. Enter your setup password. If the password is correct, the remote modem responds with:
OK
5. You can now send AT commands to the remote modem.
6. When you have finished configuring the remote modem, save the new configuration by typing **AT&W0<CR>**, then type **ATO<CR>** to exit remote configuration. The modem responds with the following menu:
 1. *DATA Mode*
 2. *COMMAND Mode*
7. Type the number **1** to return to data mode. You can then break the connection in the normal way.

CAUTION: *If you hang up while you are in remote configuration mode, it may lock up the remote modem.*

Setup

The first time you configure a modem remotely, you should set its passwords and possibly its remote configuration escape character. Multi-Tech modems are shipped with a default login password (MULTI-TECH) and setup password (MODEMSETUP). Because anyone who has an owner's manual knows the default passwords, for security you should change them—but don't forget them!

Changing the Passwords

1. Establish a remote configuration link with the remote modem as described above.
2. Type **AT#IMULTI-TECH** (or **AT#Ixxxxxx** if you have replaced the MULTI-TECH password with **xxxxxx**) and press ENTER. The modem responds with *OK* if the login password is correct, and *ERROR* if it is wrong.
3. Type **AT#SMODEMSETUP** (or **AT#Syyyyyy** if you have replaced the MODEMSETUP password with **yyyyyy**) and press ENTER. The modem responds with *OK* if the setup password is correct, and *ERROR* if it is wrong.
4. To change the login password, type **AT#I=xxxxxx**, where **xxxxxx** stands for the password, and press ENTER. The password may include any keyboard characters, but must be six to ten characters long. The modem responds with *OK*.
5. To change the setup password, type **AT#S=yyyyyy**, where **yyyyyy** stands for the password, and press ENTER. The password may include any keyboard characters, but must be six to ten characters long. The modem responds with *OK*.
6. The new passwords are saved automatically. You may now either enter more AT commands or exit remote configuration with **ATO<CR>**. The next time you remotely configure the modem you must use the new setup password.

Note: Passwords are case sensitive. The next time you enter the password, it must be in the same case as you set it up.

Changing the Remote Escape Character

To increase security, you may wish to change the remote modem's remote configuration escape character. The remote configuration escape character is stored in register **S13**. The factory default is 37, which is the ASCII code for the percent character (%). Setting **S13** to 0 (zero) will disable remote configuration entirely—but if you do this remotely, you won't be able to change it back remotely!

1. Establish a remote configuration link with the remote modem as described above.
2. Type **ATS13=n**, where *n* is the ASCII code for the new remote configuration escape character, then press ENTER.
3. Save the new value by typing **AT&W** and pressing ENTER.
4. Type **ATO<CR>**, then **1**, to exit remote configuration.

Index

Index

A

- Aborttimer 19, 21, 28, 29, 59, 63
- Analog loopback test 82
- Answer command 21, 52
- Answer mode 27, 46, 52
- Answer Tone command 36
- Answerback command 35
- Answering a call 52, 63
- Asymmetric Bit Rate command 40
- Asynchronous Word Length command 49
- AT Command Control command 21, 36
- AT Command Summary 98
- AT commands 21
 - , (comma) 28, 59
 - ! (exclamation mark) 28
 - #A 36
 - #F 37
 - #I 53
 - #L 43
 - #S 53
 - #T 39
 - #V 40
 - #X 51
 - \$ 29
 - \$A 44, 78
 - \$BA 45, 46, 76, 77
 - \$E 44, 79
 - \$EB 49
 - \$F 44, 78
 - \$MB 36, 45, 76
 - \$R 44, 79
 - \$SB 46, 77
 - \$T 39
 - %%AT<CR> 53
 - %DC 21, 36
 - %DF 54
 - %DP 54
 - %E 52
 - %F 40
 - &A 35
 - &BS 49, 78
 - &C 41, 60
 - &CD 37
 - &D 41
 - &E0 43
 - &E1 43
 - &E10 50
 - &E11 50
 - &E12 51
 - &E13 51
 - &E14 43
 - &E15 43
 - &E2 43
 - &E3 49
 - &E4 49
 - &E5 50
 - &E6 50
 - &E7 50, 73
 - &E8 50
 - &E9 50
 - &F 32, 64
 - &G 38
 - &P 38, 92
 - &Q 34
 - &R 41, 60
 - &RA 40
 - &RD 38
 - &RF 42
 - &RN 48
 - &RP 54
 - &RR 48
 - &S 42, 60
 - &SF 42
 - &T 55, 83
 - &W 32, 33, 63, 64
 - *H 38, 62
 - +++AT<CR> 19, 52, 111, 112, 113
 - : 26
 - :(colon) 28
 - ;(semicolon) 28
 - <BREAK>AT<CR> 52, 111, 112, 113
 - >DT 37
 - @ 28
 - A 21, 52
 - A/ 47

- A: 26
 AT 21, 22
 attention code 21, 22
 B 36
 command string limit 22
 D 21, 26
 D...N... 30
 disabling command mode 21, 36
 E 34
 editing 22
 functional summary 23, 24, 25
 H 19, 26
 I 47
 L 31
 L10 54
 L11 54
 L5 47, 64
 L6 47, 64
 L7 47, 64
 L8 47, 55
 L9 54
 N 30
 N...N... 30
 O 19
 P 27
 parameters 22
 Q 34
 R 27
 S = 63
 S ? 63
 structure of 22
 summary 98
 T 27
 U 55
 V 35
 W 27
 X 27, 28, 35
 Y 39
 Z 33
- Autoanswer 18, 21, 45, 57, 63
 disabling 57
 Autoreliable Buffering command 44, 78
 Autoreliable Fallback Character command 44
 Autoreliable mode 43, 44
 Autoreliable Mode command 43, 70
- B**
- Backspace character 22, 58
 Baud Adjust command 45, 76, 77
 Baud rate
 modem 45
 serial port 45, 46
 Bell standards 36
 Blind dialing 26, 30, 35
 Break signal 39, 60, 113
 definition 111
 escape sequence 52
 Busy Out After Disconnect command 38
 Busy signal 26, 28, 30, 35, 38, 59
 Busy switches 15
 Busy-Out After Disconnect command 62
 Busy-out state 15
- C**
- Call Card Tone Detect command 29
 Call termination 19
 Calling Tone command 39
 Canadian Limitations Notice 11
 Carriage return character 58
 Carrier Detect Control command 41
 Carrier, loss of 59
 CBX phone systems 41, 60
 CD signal 15
 control of 41
 disconnect drop time 60
 DSR interaction 42
 LED indicator 82
 response time 59
 Clear to Send Control command 41
 Cleardown at Disconnect command 37
 Comma 59
 Command buffer 22, 61, 113
 Command mode 21, 111
 disabling 21, 36
 Command mode control 36
 Command string 21, 30
 Compression, data 66, 68, 74
 Configuration
 default 33
 Continuous Redial command 26, 28

CTS signal
 control of 41
 disconnect drop time 60
 flow control 49
 RTS interaction 42
 CTS/RTS interaction control 42

D

DAA 9
 Data bit 49
 Data compression 66, 68, 74
 speed conversion 45
 Data Compression command 43
 Data Set Ready Control command 42
 Data Terminal Ready Control command 41
 Description of MT2834MR6 9
 Diagnostic commands 55
 Dial a Stored Number command 30
 Dial command 21, 26
 Dial pulses 92
 Dial tone 26
 wait time 35, 58
 Dial tone frequencies 93
 Dialing
 a phone number 26
 a stored number 30
 automatic 12
 blind dialing 26, 30, 35
 continuous redialing 26
 modifiers 27
 pause time 28, 59, 63
 smart dialing 26, 35
 Dialing Pause command 28
 Digital loopback tests 83, 84
 Dimensions of MT2834MR6 14
 Disconnect delay time 19
 Disconnecting 44
 after DTR drop 60
 drop time 41, 42, 60
 inactivity timer 61
 Display Line Probe Data command 54
 DSR signal
 CD interaction 42
 control of 42
 disconnect drop time 60

DTE (data terminal equipment) 51
 DTMF (dual tone multifrequency)
 detection 37
 dialing 27
 frequencies 93
 DTMF Detection command 37
 DTR signal 18, 19
 busy-in time 61
 busy-out time 61
 control of 41
 disconnect drop time 60

E

Echo Canceler Frequency Offset Compensation
 command 40
 Echo Command Mode Characters command 34
 ENQ/ACK Pacing command 50
 Error correction 66, 68, 74
 at 300 bps 44
 automatic 43
 disabling 43
 selecting 43, 44
 Error Correction Modes command 43
 Escape code character 57
 Escape Sequence Options command 52
 Escape sequence timeout 61, 113
 Escape sequences 52, 112
 +++AT<CR> 52, 111, 112
 <BREAK>AT<CR> 52, 111, 112
 aborting 113
 in-band 111
 Multi-Tech 111
 options 52
 out-of-band 111, 113
 remote configuration 53
 S-registers 112, 113
 selecting 112
 Extended codes 35

F

Fallback 36, 37
 Fallback Modes command 37
 Fax warning 10
 FCC regulations 9, 10
 File transfer protocol 68

Flash On-Hook command 28
 Flow control 41, 49, 50, 51, 74
 commands 49
 CTS/RTS enable 49
 disabling 49
 hardware (RTS/CTS) 72
 no-error correction mode 73
 non-error correction mode 50
 software (XON/XOFF) 72
 XON/XOFF pass through 50
 Flow Control Disable command 49
 Format Line Probe Data command 54
 Fuses 14

G

Go Back Online command 52
 Guard Tones command 38

H

Handshake 18, 36
 Hanging up 19, 26, 111
 Hardware Flow Control command 49

I

Immediate Line Probe command 54
 Inactivity timer 19, 61
 Indicators 15
 Industry Canada regulations 26
 Inquire Product Code command 47
 Installation 16
 Internet addresses 89

K

Kermit 67

L

LED indicators 15
 Line feed character 58
 Line probe 54
 List Current Operating Parameters command 47
 List Current S-Register Values command 47
 List Online Diagnostics command 47
 List Stored Telephone Numbers command 31
 Listing stored values 31, 47

Load Default Configuration command 32
 Login Password command 53
 Long space break 39
 Long Space Disconnect command 39
 Loopback Test Modes command 55
 Loopback Testing 81
 Loss of carrier 19

M

Manual organization 8
 Maximum Block Size command 78
 Maximum Reliable Block Size command 49
 Memory
 nonvolatile (NVRAM) 22, 30, 32, 33, 64
 read-only (ROM) 22, 32, 33, 64
 MNP 3–5 49, 68
 MNP error correction enable 43
 Modem Baud Rate command 36, 45, 76
 Modes of operation 70
 Multi-Tech Internet sites 89
 MultiModemManager Software 81

N

Noise 39, 61
 Non-error correction mode 44, 50, 61, 70
 Non-Error Correction Mode Flow Control command 50
 Number Linking command 30
 Number of XOFF Characters command 51
 NVRAM (nonvolatile random access memory) 22, 30, 32, 33, 64

O

O 52
 On-Hook/Off-Hook command 26
 Online mode 21, 52, 57, 82, 83, 111
 ordering replacement parts 89
 Originate mode 27, 46, 82
 Originating a call 43, 45
 Out-of-band escape sequence 52
 Out-of-service state (OOS) 15
 Out-of-service time 38, 62

P

Pacing 49, 50, 73
 enable/disable 51
 ENQ/ACK 50, 73
 Pacing command 51, 74
 Parameters 22, 32, 47
 default 22, 41
 Parity 49
 PBX phone systems 27, 60
 PBX/CBX disconnect drop time 41, 42, 60
 Power 14
 Pulse ratios, setting 92
 Pulse-Dial command 27
 Pulse-Dial Ratios command 38

Q

Quiet Answer command 28

R

Rate Renegotiation command 48
 RD signal 15
 Read Line Probe Data command 54
 Reliable mode 43, 49
 Reliable Mode command 43, 70
 Remote configuration escape character 60
 Remote Digital Loopback command 55
 Repeat Last Command command 47
 replacement parts 89
 Reset Modem command 33
 Response commands 34
 Result codes 22, 34, 35, 75
 call progress selection 35
 enable/disable 34
 extended codes 35
 Multi-Tech 94
 set selection 34
 standard 95
 summary 94
 verbose/terse selection 35
 Result Codes (Multi-Tech or Standard AT)
 command 34
 Result Codes (Verbose/Terse) command 35
 Result Codes and Call Progress Selection
 command 27, 35

Result Codes Enable/Disable command 34
 Retrain command 48
 Retransmit Count command 44, 79
 Return character 58
 Return to Command Mode command 28
 Reverse Originate/Answer Mode command 27
 Rings
 counting 57
 number till answer 57, 63
 square wave detection 38
 ROM (read-only memory) 22, 32, 33, 64
 RS-232C 41, 42, 49
 cable and connector diagrams 110
 controls 41, 42
 specifications 106
 RTS signal 41
 CTS interaction 42

S

S-registers 47, 63, 113
 assigning a value 63
 definition 57
 reading 63
 S0 57, 63
 S1 57
 S10 19, 59
 S11 60
 S13 60
 S17 60
 S2 57
 S24 41, 42, 60
 S25 60
 S3 58
 S30 19, 61
 S32 61, 112, 113
 S34 61, 113
 S36 61
 S37 61
 S4 58
 S43 62
 S48 62
 S5 22, 58
 S6 26, 35, 58
 S7 19, 21, 28, 29, 59, 63
 S8 28, 59, 63

S9 59
 S94 38, 62
 summary 96
 Safety 16
 Serial port baud rate 46
 Serial Port Baud Rate command 77
 Set Pulse Dial Ratios command 92
 Setup Password command 53
 Smart dialing 26, 28, 35
 Specifications 12
 Speed conversion 45, 46, 66, 75
 Speed, data transmission 15
 Speed indicator 15
 Square Wave Ring Detect command 38
 Start bit 49
 Stop bit 49
 Store Configuration command 32, 33, 64
 Store Phone Number command 30
 Storing a configuration 32, 63

T

TD signal 15
 Technical specifications 12
 Terminal mode 83
 Terminating a call 19
 Testing 55, 81, 83, 84
 commands 55
 loopback tests 55, 81, 82, 83, 84
 Time independent escape sequence 111
 Tone detection 37
 Tone dialing 93
 Tone-Dial command 27
 Tone-dialing 60
 Transmission speed 45, 46
 Trellis-Coded Modulation command 39

V

V.21 36
 V.22 36
 V.22bis 36
 V.32 37
 V.32bis 37
 V.32terbo 37, 40
 V.32terbo Handshake command 40
 V.34 37, 40, 54

asymmetric bit rate 40
 connect speed 62
 echo canceler frequency offset compensation 40
 V.32terbo handshake 40
 V.42 43, 44
 V.42 Error Correction at 300 bps command 44
 V.42 Error Correction Mode command 43, 69
 V.54 tests 82, 83, 84

W

Wait for New Dial Tone command 27
 Wait-for-carrier mode 21

X

X.28 111
 Xmodem 67
 XON/XOFF 50, 51
 XON/XOFF Flow Control command 50
 XON/XOFF Pass-Through command 50



S000326A