

Automate[®]
V I D E O

OWNER'S GUIDE

INSTALLATION GUIDE



9" (16:9) Overhead Video Monitor

MODEL OHV901A

NON-TRANSFERABLE LIMITED CONSUMER WARRANTY

.....

Directed Electronics, Inc. (Directed) promises to the original purchaser that the automotive video monitor and/or source unit(s) (the Product), excluding accessories, purchased and installed from a Directed authorized dealer within ninety (90) days after purchase of the new vehicle, in which the Product is installed, will be free from defects in materials or workmanship under normal use and conditions for a period of three (3) years from date of purchase or the first 36,000 miles as registered on the new vehicle's odometer reading at time of delivery of the Product for warranty service, whichever occurs first. Product purchased or installed more than ninety (90) days after the new vehicle is purchased are warranted for a period of one (1) year from date of purchase of the Product.

Directed promises to the original purchaser that all video accessories will be free from defects in materials and workmanship under normal use and condition for a period of ninety (90) days after the date of purchase. A sales receipt and/or warranty registration card is required to provide proof of date of purchase of the Product or accessories.

Should the Product prove to be defective during the applicable warranty period, the Product will be repaired or replaced with a new or comparable reconditioned part(s), at Directed's election. To obtain warranty service, the Product must be returned to a Directed authorized dealer along with proof of purchase and proof of installation by an Authorized Directed Dealer.

Note: This warranty does not cover labor costs for the removal and/or reinstallation of the Product. IN ORDER FOR THIS WARRANTY TO BE VALID, YOUR PRODUCT MUST BE SHIPPED WITH PROOF OF PURCHASE AND INSTALLATION BY AN AUTHORIZED DIRECTED DEALER. ALL PRODUCTS RECEIVED BY DIRECTED FOR WARRANTY REPAIR WITHOUT PROOF OF DIRECTED DEALER INSTALLATION WILL BE DENIED.

This warranty is non-transferable and does not apply to any Product that has been modified or used in a manner contrary to its intended purpose, and does not cover damage to the Product caused by installation or removal of the Product. This warranty is **VOID** if the product has been damaged by accident or unreasonable use, negligence, acts of God, neglect, improper service or other causes not arising out of defect in materials or construction. This warranty does not cover the elimination of externally generated static or noise, or the correction of antenna problems or weak television reception, damage to tapes, video games, software, camcorders, discs, speakers, accessories or vehicle electrical systems, cosmetic damage or damage due to negligence, misuse, abuse, failure to follow operating instructions, accidental spills or customer applied cleaners, damage due to environmental causes such as floods, airborne fallout, chemicals, salt, hail, windstorms, lightning or extreme temperatures, damage due to accidents, road hazards, fire, theft, loss or vandalism, damage due to improper connection to equipment of another manufacturer, modification of existing equipment, damage caused by faulty media or the cleaning of components, or Product which has been opened or tampered with for any reason or which has been damaged due to alteration or service performed by anyone other than Directed Electronics, Inc.

ALL WARRANTIES INCLUDING BUT NOT LIMITED TO EXPRESS WARRANTY, IMPLIED WARRANTY, WARRANTY OF MERCHANTABILITY, FITNESS FOR PARTICULAR PURPOSE, AND WARRANTY OF NON-INFRINGEMENT OF INTELLECTUAL PROPERTY ARE EXPRESSLY EXCLUDED TO THE MAXIMUM EXTENT ALLOWED BY LAW, AND DIRECTED NEITHER ASSUMES NOR AUTHORIZES ANY PERSON TO ASSUME FOR IT ANY LIABILITY IN CONNECTION WITH THE SALE OF THE PRODUCT. DIRECTED HAS ABSOLUTELY NO LIABILITY FOR ANY AND ALL ACTS OF THIRD PARTIES INCLUDING ITS LICENSED DEALERS OR INSTALLERS. IN NO EVENT WILL DIRECTED ELECTRONICS, INC. BE LIABLE FOR ANY INCIDENTAL, SPECIAL OR CONSEQUENTIAL DAMAGES (INCLUDING LOSS OF PROFITS), BY PURCHASING THIS PRODUCT, THE CONSUMER AGREES AND CONSENTS THAT ALL DISPUTES BETWEEN THE CONSUMER AND DIRECTED SHALL BE RESOLVED IN ACCORDANCE WITH CALIFORNIA LAWS IN SAN DIEGO COUNTY, CALIFORNIA.

Some states do not allow limitation on how long an implied warranty lasts. In such states, the limitations or exclusions of this Limited Warranty may not apply. Some states do not allow the exclusion or limitation of incidental or consequential damages. In such states, the exclusion or limitation of this Limited Warranty may not apply to you. This Limited Warranty gives you specific legal rights, and you may have other rights which vary from state to state.

March 01, 2005

Table of Contents

Non-Transferable Limited One Year Consumer Warranty	2
Safety Instructions and Cautions	4
Welcome	5
What's Included	5
Important	5
When Cleaning the Vehicle	5
While Driving	5
When Parked	5
Proper Use	5
Repairs	6
Radio/TV Tuner Use	6
Installation	6
Picture Quality	6
Important Information	7
FCC Notice	7
Your Warranty	7
Controls	8
Monitor	8
Setting the Screen Mode	9
Remote Control Unit	10
Remote Buttons	10
IR Remote Feedthrough	11
Battery Replacement	12
Precautions	12
Operating the Monitor	13
Open/Close the Display Monitor	13
Power Up/Down the Display Monitor	14
P (Picture-In-Picture/Split Screen)	14
Source (Mode)	14
Menu (Console Menu)	15
Door Light On/Off	15
Courtesy Light On/Off	15
Installing Options	16
Installation Guide	17
Precautions	17
Electrical Connections	18
Signal Connections	19
Typical Wiring Diagram	20
Installation Procedure	21
System Wiring Diagram Example	23
Troubleshooting	24
Specifications	26

Safety Instructions and Cautions



WARNING: TO REDUCE THE RISK OF FIRE OR ELECTRIC SHOCK, DO NOT EXPOSE THIS EQUIPMENT TO RAIN OR MOISTURE. TO REDUCE THE RISK OF FIRE OR ELECTRIC SHOCK AND ANNOYING INTERFERENCE, USE ONLY THE INCLUDED HARDWARE.

THIS MONITOR IS ONLY DESIGNED FOR REAR SEAT PASSENGER VIEWING AND IS NOT INTENDED FOR VIEWING BY THE DRIVER WHILE THE VEHICLE IS IN MOTION. SUCH USE MAY DISTRACT THE DRIVER OR INTERFERE WITH THE SAFE OPERATION OF THE VEHICLE, AND MAY ALSO VIOLATE STATE LAW.

DIRECTED ELECTRONICS, INC. DISCLAIMS ANY LIABILITY FOR ANY BODILY INJURY, INCLUDING FATALITIES, OR PROPERTY DAMAGE THAT MAY RESULT FROM ANY IMPROPER OR UNINTENDED USES OF THIS PRODUCT.

SHOULD THE LCD PANEL BREAK OR LEAK FLUID, AVOID ALL CONTACT WITH THE UNIT. IF YOU SHOULD COME IN CONTACT WITH THE LEAKED FLUID, WASH THE AFFECTED AREA THOROUGHLY WITH WATER AND SEEK IMMEDIATE MEDICAL ATTENTION.

- During operation, if the unit should over-heat or malfunction, switch off the unit and see your dealer. Do not disassemble the unit as there are no user-serviceable parts in this unit and the warranty will be voided.
- Should there be a need to replace a blown fuse, turn off the unit and disconnect all power to the player. Use only the correct rating fuse to avoid electrical damage to the unit.
- Only operate the monitor as described in this guide. Attempts to use or modify this monitor contrary to the descriptions in this guide may cause damage and void the warranty.
- Extremes in temperature can cause abnormal display operation. This monitor has an optimal operating temperature range between 32–120 degrees Fahrenheit. If the vehicle interior is outside this range, do NOT operate the monitor until the temperature is within its operating range.
- Exposure to moisture or dust can cause harmful damage to the internal electronics. Do not mount near cup holders or in areas where spills may occur.
- This monitor is designed for use in vehicles with standard (-) 12 volt ground electrical systems.
- Do not operate for an extended period of time without the engine running or the vehicle's battery voltage may drop to levels precluding engine starting.
- Do not drop the LCD panel or subject it to direct impact. This will damage the panel and/or the back light element.
- When operating the unit, avoid contact with the LCD panel.
- Prevent metal or foreign objects being locked between the LCD screen and the enclosure.
- Keep unit away from equipment with strong magnets such as large loudspeakers.

Welcome

Thank you for your purchase of Directed's Overhead Monitor. Prior to operating this unit, please fully read this instruction manual and retain it for future reference.

What's Included

The following items are included with your purchase:

- Monitor
- A/V Switch Box
- (2) Headphones (HP100)
- Remote Control
- Mounting Plate (with 4 screws)
- Power Harness
- DIN Cable
- Domelight Harness
- Mounting Trim Bezel

Important

WHEN CLEANING THE VEHICLE

Do not spray this unit with water or cleaning solutions. Moisture and the chemicals found in cleaning fluids could damage the consoles finish and interior electronics. A soft damp, lens cleaning cloth should be used to wipe the screen. Do NOT use any type of scouring pad, abrasive cleaners, or solvents.

WHILE DRIVING

This unit is intended for use in the rear seat area only. It is illegal in some jurisdictions to install the unit in a location that would allow the driver to view it while driving.

WHEN PARKED

The screen is easily visible when deployed. Always close the screen when parking for an extended period of time to avoid potential theft or extended exposure to direct sunlight.

PROPER USE

Do not touch the screen. Do not pull or hang from the fold down monitor door.

REPAIRS

If the monitor stops working for any reason, discontinue use immediately and consult with your retailer about any necessary repairs.

RADIO/TV TUNER USE

When the unit is used in conjunction with a Radio/TV tuner, please assure that the receiver is manufactured to receive television broadcast signals that are transmitted via terrestrial radio waves. Reception quality will change and vary according to vehicle location and weather conditions.

INSTALLATION

Avoid installing the monitor at a location, where it will be under direct sunlight or a hot air vent. The operating temperature of the unit is from 32–120°F (0–50°C). Install the unit at a dry location, where it is away from condensation.

Use only the correct size fasteners and cables during installation. Failure to do so may cause a mechanical or electrical failure and create a fire hazard. The installation should be done by an authorized Directed dealer.

NOTE: *If the internal temperature of the vehicle is higher than the normal operating temperature, please allow the vehicle to cool down (or warm up) prior to operating the unit.*

PICTURE QUALITY

The picture quality of this LCD unit depends strictly on its installed location. To achieve the best picture quality, adjust the brightness control or viewing angle of the unit until the optimum viewing is achieved.

Important Information

FCC NOTICE

This device complies with Part 15 of FCC rules. Operation is subject to the following two conditions: (1) This device may not cause harmful interference, and (2) this device must accept any interference received, including interference that may cause undesirable operation.

Changes or modifications not expressly approved by the party responsible for compliance could void the user's authority to operate this device.





YOUR WARRANTY

Your warranty registration must be completely filled out and returned within 10 days of purchase. Your product warranty will not be validated if your warranty registration is not returned. Make sure you receive the warranty registration from your dealer. It is also necessary to keep your proof of purchase, which reflects that the product was installed by an authorized dealer.

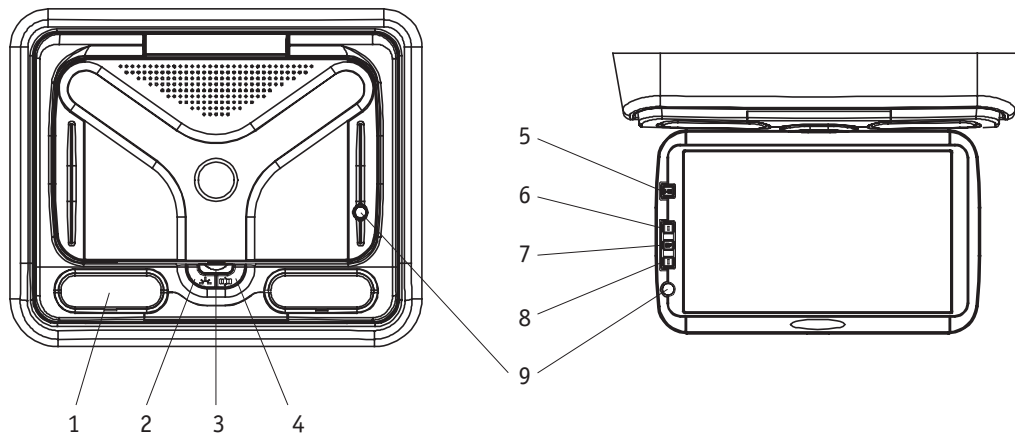
Controls

MONITOR



1. DOME LIGHTS—Quantity 2.
2.  DOOR LIGHT On/Off—Engage this switch to have the door open switch activate the dome lights.
3. OPEN/CLOSE—The latch to open or close the LCD screen.
4.  COURTESY LIGHT—Activate this switch to "ON/OFF" to activate the dome lights on the monitor.
5. POWER—Power On/Off button, Source Select button. Hold for 3-seconds to turn power off. Each press of this button cycles through sources DVD, AV1, or AV2.
6.  UP Button—Used in conjunction with the MENU button to scroll up (or increase) the menu setting.
7. MENU—Used to set FM Frequency, Brightness, Contrast, Saturation, Hue, or Reset (menu parameters). The menu will exit if no action is taken within a few seconds.
8.  DOWN Button—Used in conjunction with the MENU button to scroll down (or decrease) the menu setting.
9. IR Receiver—Infrared receiver which receives commands from the remote control.

Setting the Screen Mode

.....



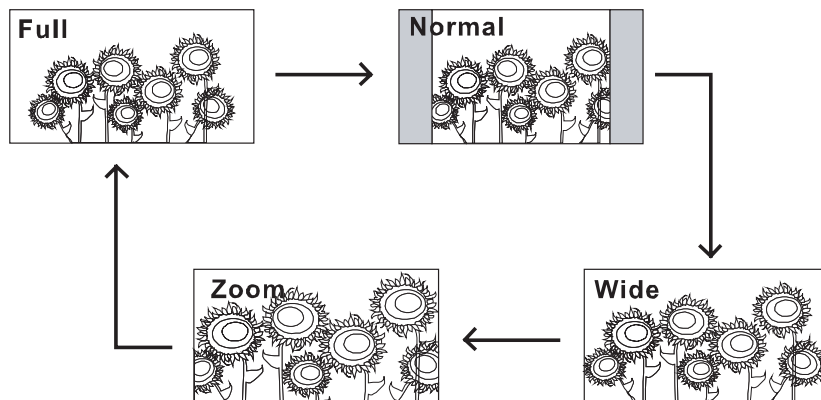



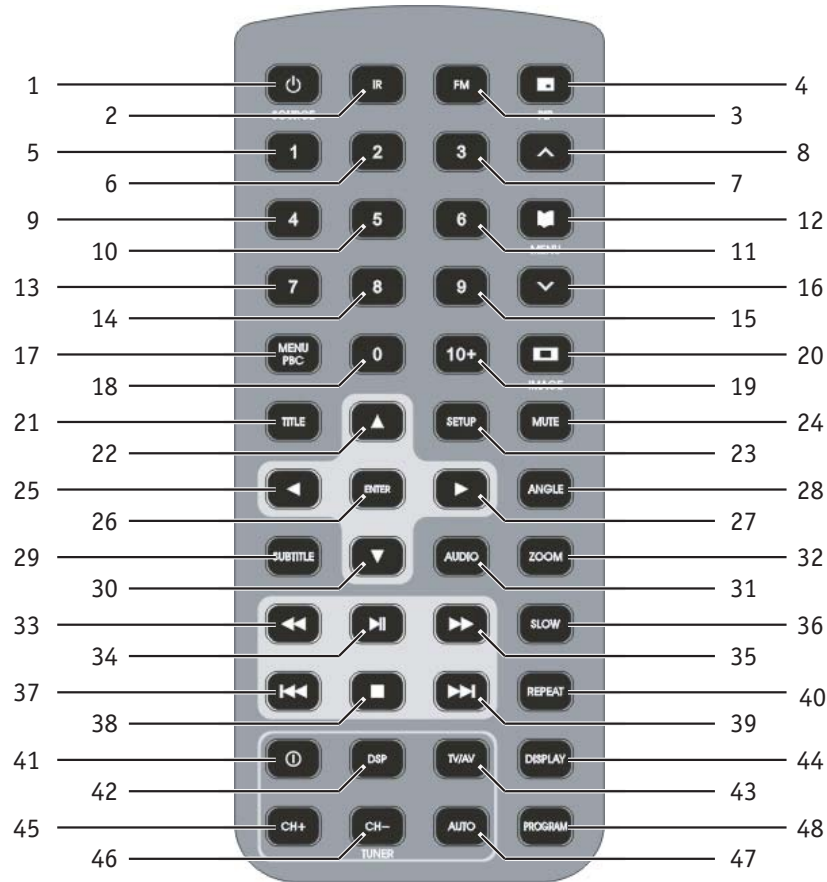

The overhead monitor has 4 different screen modes. These are: FULL, NORMAL, WIDE, and ZOOM. Press the Image  button on the remote control to access the different screen modes. The last mode set is displayed on the screen. Each time the Mode button is pressed, the screen switches in the following sequence.









Remote Control Unit

REMOTE BUTTONS



- | | |
|--|--|
| 1. POWER (source)  | 28. ANGLE |
| 2. IR (on/off) | 29. SUBTITLE (on/off) |
| 3. FM (on/off) | 30. DOWN (Cursor)  |
| 4. Picture (PIP)  (n/a in this model) | 31. AUDIO |
| 5-7. Numeric | 32. ZOOM (2, 3, 4, 1/2, 1/3, 1/4, OFF) |
| 8. UP (display)  | 33. F.REV (Fast Reverse)  |
| 9-11. Numeric | 34. PLAY/PAUSE  |
| 12. Console MENU  | 35. F.FWD (Fast Forward)  |
| 13-15. Numeric | 36. SLOW |

- | | |
|--|--|
| 16. DOWN (display)  | 37. BACK  |
| 17. MENU/PBC | 38. STOP |
| 18-19 Numeric | 39. NEXT  |
| 20. Image  (wide, zoom, full, normal) | 40. REPEAT |
| 21. TITLE | 41. POWER (Tuner)* |
| 22. UP (Cursor)  | 42. DSP (channel display)* |
| 23. SETUP | 43. TV/AV (selects Tuner or Aux input)* |
| 24. MUTE (on/off) | 44. DISPLAY |
| 25. LEFT (Cursor)  | 45. CH+ (channel up)* |
| 26. ENTER | 46. CH- (channel down)* |
| 27. RIGHT (Cursor)  | 47. AUTO (auto programming of TV channels)* |
| | 48. PROGRAM |

IR REMOTE FEEDTHROUGH

The remote will operate, through the monitor, and transmit commands to other compatible devices attached to the AV1 or AV2 source at the switch-box. The IR signals are compatible with models DV2602, DV2605 DVD players, and TV100 tuner.

NOTE: *This remote is for the operation of the LCD screen and for the optional DVD player. Some remote buttons only function when the optional DVD player is installed in the monitor.*

* These buttons are for use only with the TV tuner (model TV100).

BATTERY REPLACEMENT

NOTE: Before using remote after installation, remove the battery plastic protective slip.

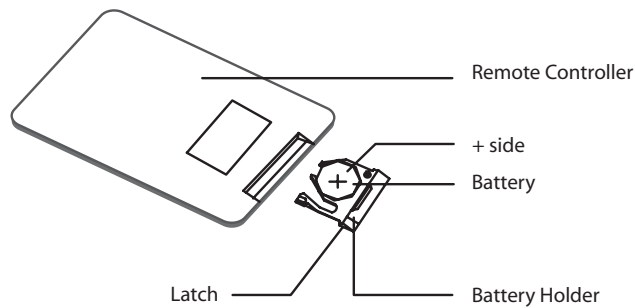

1. Move the small latch to the right and slide out the battery holder.
2. Remove old battery and replace it with a new battery (CR2025) with the positive “+” sign facing as shown above.
3. Push battery holder back into its compartment until it is locked.

PRECAUTIONS

1. Properly dispose of used battery.
2. Do not misuse battery by shorting the positive “+” and negative “-” terminal or put it into fire. Overheating may cause the battery to explode and cause a fire hazard.
3. If the remote is not to be used for a long period, remove the battery from the remote to prevent damage from battery leakage.
4. To avoid accidents, prevent children from playing with the battery.

Operating the Monitor

OPEN/CLOSE THE DISPLAY MONITOR

To open the display monitor, push the "OPEN" button and pull the monitor down *by the middle* of the LCD to the desired position.



WARNING: THE LCD MONITOR MUST ALWAYS BE OPENED, CLOSED, OR POSITIONED FROM THE MIDDLE OF THE SCREEN AS SHOWN BY THE POINTING HAND BELOW. DO **NOT** USE THE CORNERS OF THE SCREEN, THIS CAN RESULT IN DAMAGE/LEAKAGE OF THE SCREEN.

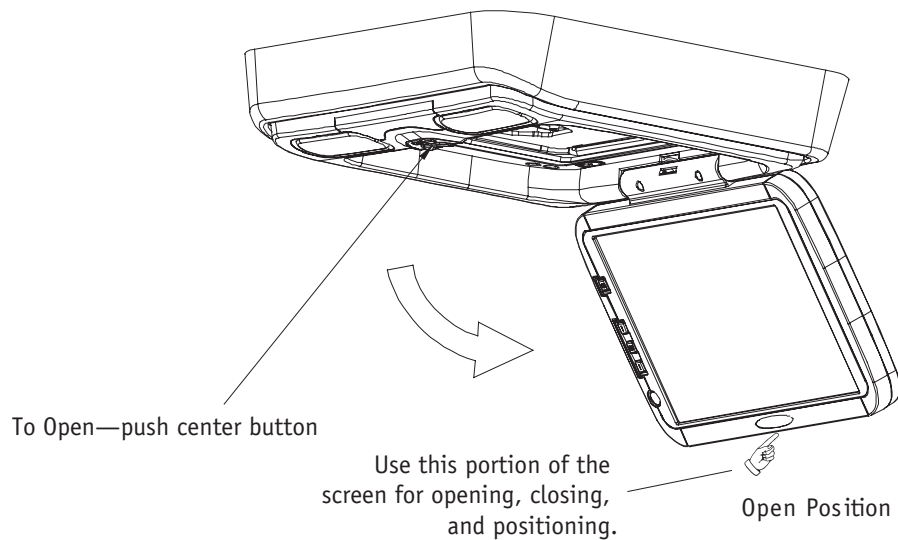



To close the display monitor, push the LCD screen up until it latches closed with an audible click.

Note: The ignition key must be in the Accessory or Ignition position in order for the monitor to have power.

Power Up/Down the Display Monitor

The unit will power up when the display monitor is unlatched and pulled down. (If the unit does not power up, press the Power  button on either the remote or the Power button on the left side of the LCD screen.

To turn the power off to the unit, press and hold for 3-seconds the POWER  button on the remote or the Power button on the left side of the LCD screen. The power will also shut Off when the display monitor is placed in the closed and latched position.

If the hand  icon or "INVALID KEY" displays in the upper left-hand corner of the screen when using the remote, it indicates that the command issued is not allowed during the mode that the monitor display is presently in, or is not available on this system.

SOURCE (MODE)

Press the  (SOURCE) button on the remote or momentarily press the POWER button on the left side of the LCD screen to select the input signal AV1, AV2 (or the optional DVD player or Hard Disk drive, if installed).

MENU (CONSOLE MENU)

Press "MENU"  button on the monitor or remote to activate the screen parameters set-up. The sequence of set-up items is as follows:

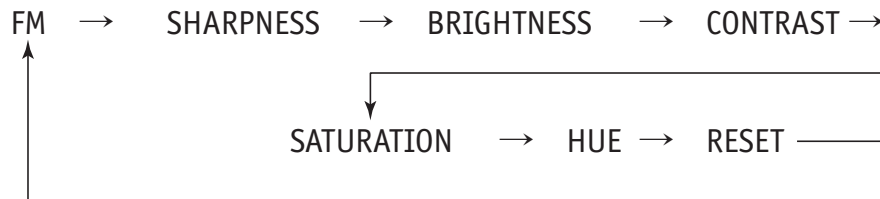

FM: Transmitting frequency

SHARPNESS: Sharpness adjustment

BRIGHTNESS: Brightness adjustment

CONTRAST: Contrast adjustment

SATURATION: Color saturation adj.

HUE: Color hue adjustment

RESET: Resets above (except FM) to factory default settings.

Once the desired setting is selected, press the cursor buttons to adjust the setting. On the remote use the up/down cursor buttons located at either side of the menu button. On the monitor use the cursor buttons to the right side of the  button. If a button is not activated within 5 seconds, this function mode will turn OFF. Once the correct function is selected, press the cursor button (to set the desired setting). If no button is pressed, the menu mode will turn OFF in about 5 seconds.

The FM frequency setting allows the monitor to transmit audio to the vehicle's radio. Use a frequency that is not interfered with from a local broadcast station. This setting also has an OFF position.

DOOR LIGHT ON/OFF

Engage this switch  on the monitor to activate the dome lights when a door is open.

NOTE: This function is operational only when the Gray wire of the dome light circuit is connected to the door switch.

COURTESY LIGHT ON/OFF

Activate this switch  on the monitor to control the dome light illumination.

Installing Options

This unit allows the mounting of an optional DVD player or Hard Drive, not provided with this model.

NOTE: Before installing any options, ensure that the Power to the Monitor is Off and that the ignition key is Off.

1. Open the monitor and remove the protective cover from the monitor.

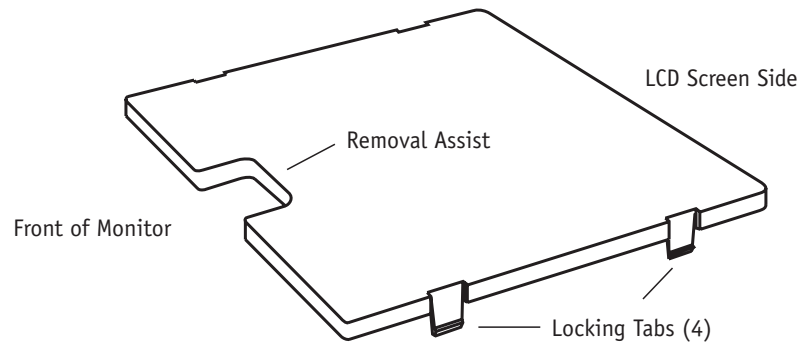

2. Store the protective cover in an area where it will not be damaged.
3. Insert the optional DVD player or Hard drive as shown below.

NOTE: The illustration below shows a typical monitor with the DVD player option.

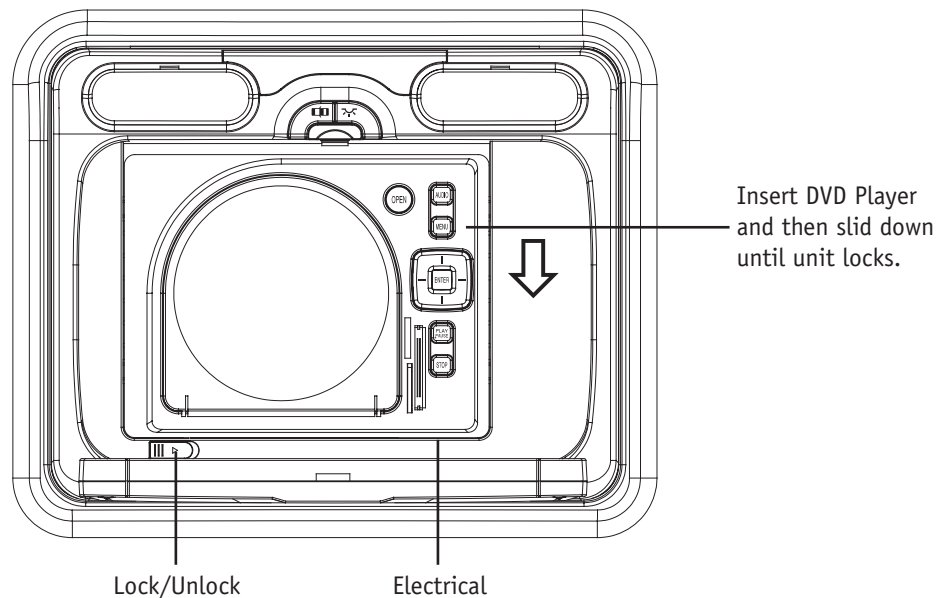

4. Refer to the manual that came with your option for operating instructions.

Installation Guide

PRECAUTIONS

1. This unit should be installed by an authorized Directed dealer.
2. When selecting a location to install this unit, be sure it does not interfere with the driver's ability to operate the vehicle or the driver's or passenger's safety.
3. This product is designed to operate with a 12V DC, negative ground battery system.
4. Disconnect the ground wire from the battery terminal prior to connecting the unit to the electrical system.

***NOTE:** Head units with security codes will have to be reset after battery power is restored.*

5. The wiring from some other products or accessories might bear similar color code as this product; however, they might be for other functions. Please refer to the electrical connection diagrams of this product prior to installation to avoid improper connection.
6. Use proper connectors and insulation to prevent electrical damage to the unit.
6. Do not connect the yellow wire and red wire together of this product directly to the +12V. Connect the red wire of this product to the ACC of the ignition key switch and yellow wire to +12V. Failure to do so may result in discharge of the battery.
7. Only supplied accessories should be used to avoid damage to the unit during installation.
8. Ensure that the display monitor is suitably installed at a location, such that it will not obstruct the rear view mirror and/or the air condition vents or operation of a sunroof.
9. Do not install this unit at a declining angle exceeding 30 degrees.
10. Do not install screws over the plane surface, which may affect the LCD screen deployment or retract function.

ELECTRICAL CONNECTIONS

Power Cable (4-pin, one pin not used)

Color Code	Function
Black	This wire is the ground source for the monitor and DVD.
Red	Accessory +12V switched power source for the monitor and DVD. This wire supplies the main power to the system (0.5A fuse).
Yellow	Constant +12V power. This wire supplies power to the DVD for last position memory (3A fuse).

Dome Light Cable (3-pin)

Color Code	Function
Black	This wire supplies the ground to the domelight circuit.
Yellow	This wire supplies +12V constant power to the domelight circuit.
Gray	This wire connects to the (-) door trigger.

SIGNAL CONNECTIONS

Adapter Audio

Color Code	Function
Red 1 (RCA)	Audio - Right (Input)
White 1 (RCA)	Audio - Left (Input)
Red 2 (RCA)	Audio - Right (Input)
White 2 (RCA)	Audio - Left (Input)
Red 3 (RCA)	Audio - Right (Output)
White 3 (RCA)	Audio - Left (Output)

Adapter Video

Color Code	Function
Yellow 1 (RCA)	Video - In (V-IN 1)
Yellow 2 (RCA)	Video - In (V-IN 2)
Yellow 3 (RCA)	Video - Out (V-OUT 1)

Adapter IR

In addition each IN 2 and IN 1 grouping has an IR output jack which passes the remote control commands to the device (VCR, CD player, TV tuner or other devices) connected to this input.

TYPICAL WIRING DIAGRAM

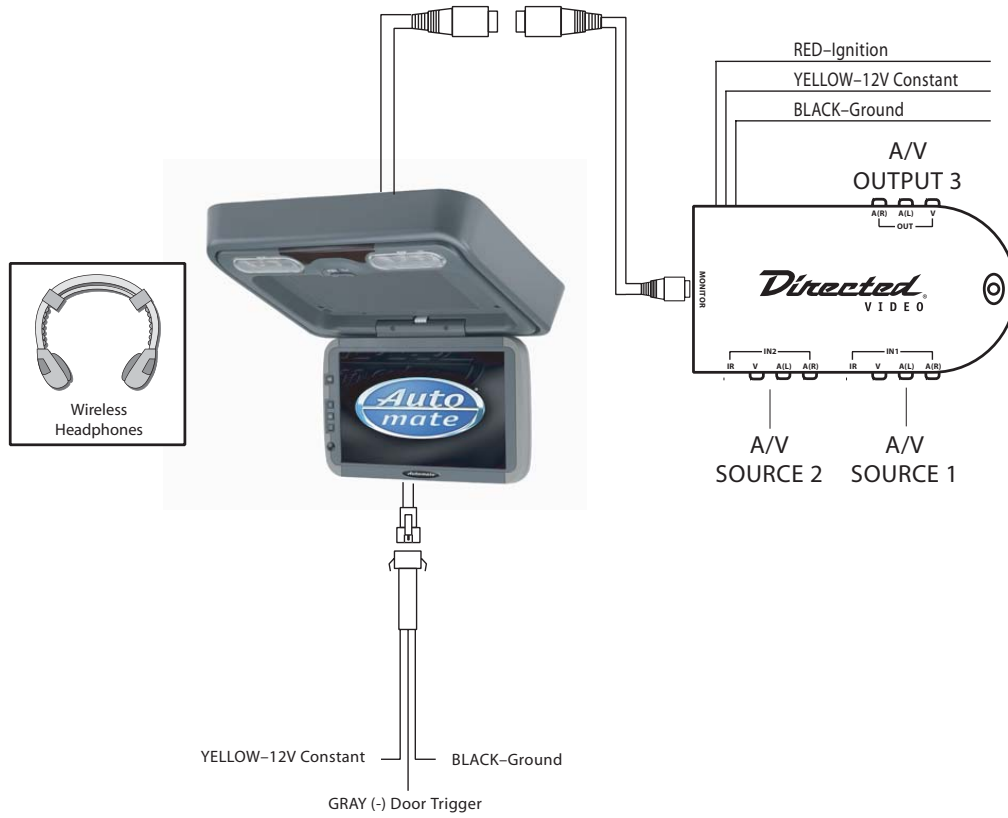

Installation Procedure

1. Identify the polarity of the dome light circuit and set the switch on the cable connection side of the overhead monitor housing to match the vehicle's door trigger polarity. Factory default position for this switch is Negative. This switch is marked with the following instruction label.

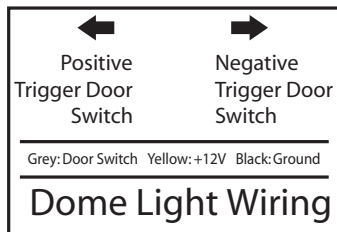

2. Test fit the overhead monitor system on the ceiling of the vehicle, verifying it is not going to interfere with the safe operation of the vehicle and is physically safe for the driver and passenger(s).
3. Once the mounting location of the overhead monitor system has been determined, carefully mark the location with masking tape.
4. Lower the vehicle's headliner down to see if a roof support beam is available to screw the mounting bracket to. If a support beam is not available to screw into, use a 3/4" piece of plywood cut to the appropriate size. Attach the plywood to the roof of the vehicle using silicone allowing adequate drying time before proceeding.
5. Screw the mounting bracket in the vehicle. **DOUBLE CHECK THE LENGTH OF THE SCREWS PRIOR TO MOUNTING THE BRACKET, TO PRECLUDE PENETRATION OF THE VEHICLE'S ROOF.**

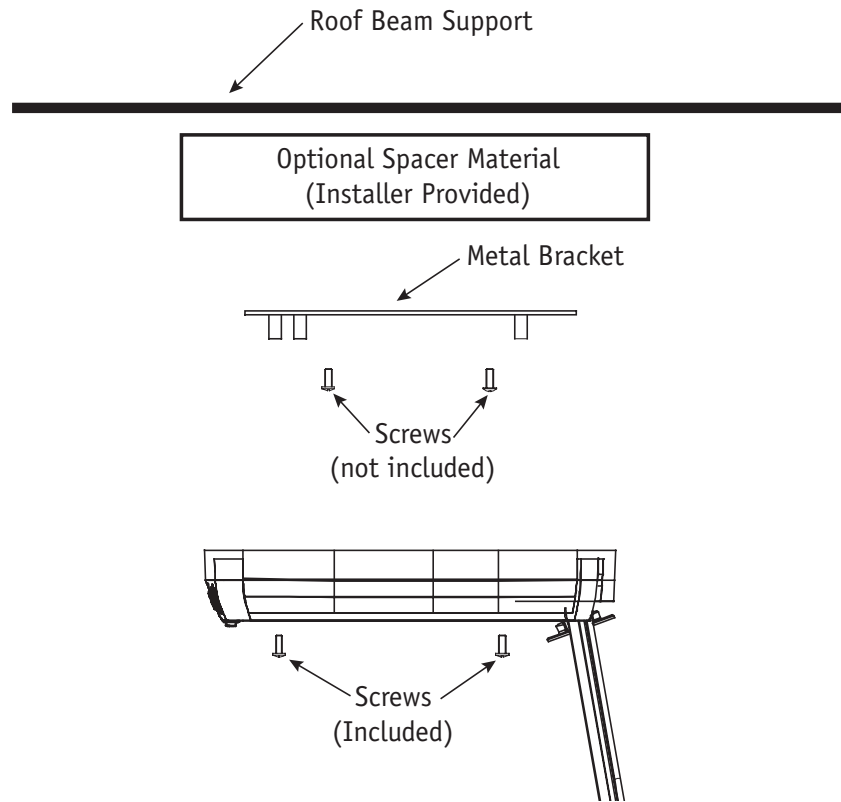

6. Cut a 1" hole in the headliner along the backside of the mounting bracket for the cables to pass through.
7. Route cables through the hole to the predetermined location of the AV source(s).
8. Identify the dome light wires in the vehicle and connect them to the corresponding dome light wires on the overhead monitor system. Ensure the domelight switch is in the correct position.
9. Plug in the AV, DIN, dome light, and power cables into the overhead monitor system.
10. Carefully hold the overhead monitor system to the mounting bracket aligning the mounting holes while screwing in the screws. (Make sure the wires and cables are not in the way while mounting the monitor).
11. Ground the Black wire of the power cable to a clean ground spot.
12. Connect the Yellow wire of the power cable to the battery positive terminal.
13. Connect the Red wire of the power cable to the Accessory wire in the ignition harness.

NOTE: Make sure you keep the ground wire of the monitor and video source as short as possible to prevent unwanted audio noise pickup from the vehicle's systems.

System Wiring Diagram Example

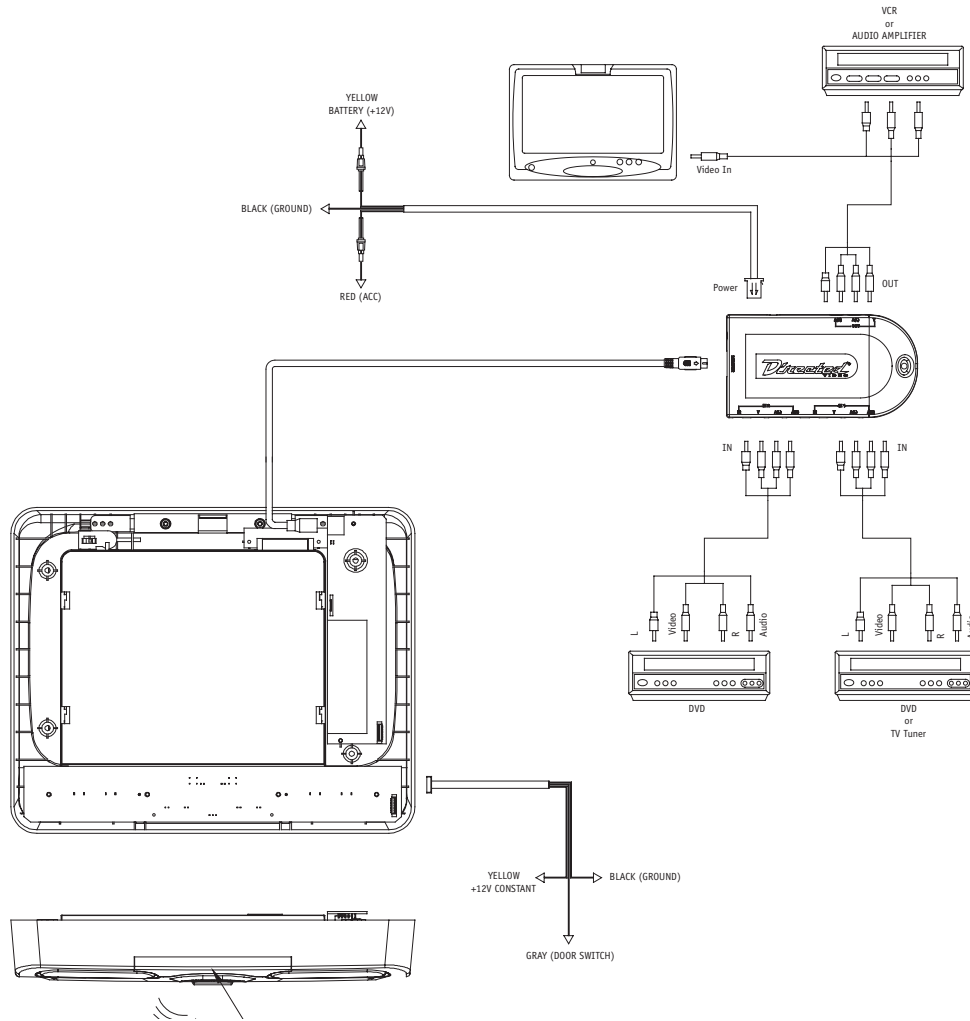

Troubleshooting

No Picture

Press the POWER (source) button (or the  button on the remote) to make sure the monitor is on and the proper source input is selected.

No Sound

If acquiring signal from another remote device (e.g. DVD player or CD player) ensure the device is setup correctly.

The DVD player is in pause, slow motion, fast forward, or fast reverse mode. Place player in play mode.

Picture Rolls

Check that the T.V. type setting is correct for the monitors and DVDs being used. PAL video often rolls on NTSC monitors.

With a DVD player and a widescreen DVD disc, there are black bars on the screen

Change the TV display mode to "WIDE" in the DVD player's setup menu. After changing this setting, if there are still black bars, press the MODE button on the remote control.

With a widescreen 16:9 monitor, I have black bars on the screen

Change the TV display mode to "Wide".

The Remote does NOT Function

Are there obstacles obstructing the view between the monitor and the remote.

The distance between the remote and monitor is too great.

The remote is not being pointed at the monitor's IR receiver.

The batteries in the remote are weak.

DISC does NOT Play (with optional DVD player installed)

Parental code is set lower than than allowed by the DVD mounted.

Ensure the disk is mounted in the player with the correct orientation (shiny side up).

The disk is warped.

The player cannot play certain formats (see the beginning of this manual).

The region code on the DVD does not match the player.

Moisture condensation has occurred within the player. Leave the unit on and the disc access cover open and try again after about 30 minutes.

The disc has not been properly finalized (formatted) when recorded. Refer to your manual that came with your disc authoring equipment.

Unit does NOT Display or Operate Correctly

Press Reset button located on the monitor along side the removable DVD player location. This resets all of the system, except for the Password and Parental Level setting.

Specifications

System		
Laser	Semiconductor laser	
Signal Formats	NTSC, PAL	
Audio Characteristics		
Frequency Response	DVD Video (PCM@ 96kHz)	20 Hz - 40 kHz \pm 1dB
	DVD Video (PCM@ 48kHz)	20 Hz - 20 kHz \pm 1dB
	CD	20 Hz - 20 kHz \pm 1dB
Signal-to-Noise Ratio	90dB	
Harmonic Distortion	0.01%	
Dynamic Range	DVD Video	95dB
	CD	95dB
Outputs (A/V Switchbox)		
Audio (phono jacks)	2 Vrms	
Video (phono jack)	1 V p-p @75 ohms	
Inputs (A/V Switchbox)		
Audio (phono jacks)	2 Vrms	
Video (phono jack)	1 V p-p	
General		
Power Requirements	14.4 VDC, 3.35 amps	
Power Consumption	42.6 watts	
Dimensions	345 mm x 65 mm x 282 mm (length/height/width)	13.6 in. x 2.6 in. x 11.1 in. (length/height/width)
Mass	1.7 kg	3.7 lbs
Operating Temperature	0°–50°C	32°–120°F
Operating Humidity	10% to 90%	

NOTE: Specifications and design are subject to change without notice.

The company behind this system is Directed Electronics, Inc.

Since its inception, Directed has had one purpose, to provide consumers with the finest vehicle security, car stereo products, rear seat entertainment, and accessories available. The recipient of more than 20 patents in the field of advanced electronic technology, Directed is ISO 9001 registered.

Quality Directed Electronics products are sold and serviced throughout North America and around the world.

Call **(800) 274-0200** for more information about our products and services.



DEI is an ISO 9001 registered company.

Directed® is committed to delivering world-class quality products and services that excite and delight our customers.



Directed Electronics, Inc.
Vista, CA 92081
www.directed.com

© 2005 Directed Electronics, Inc.—All rights reserved
N81901A 03-05