

## Operating Instructions

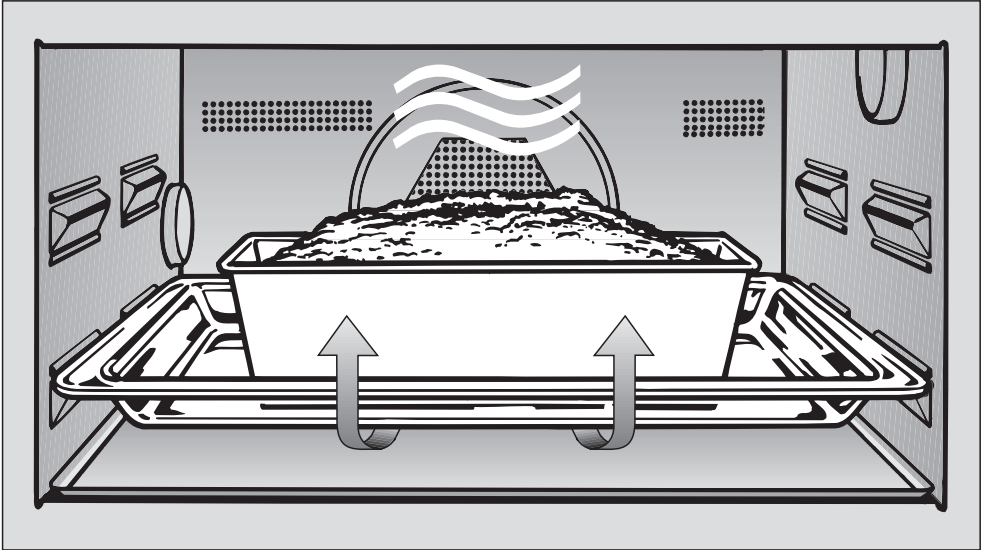

## Microwave Combination Oven H 136 MB, H 137 MB H 146 MB, H 147 MB

It is **essential** to read these operating instructions before installing or using the machine, to avoid the risk of accident, or damage to the machine.



# Description of the appliance

## Control panel

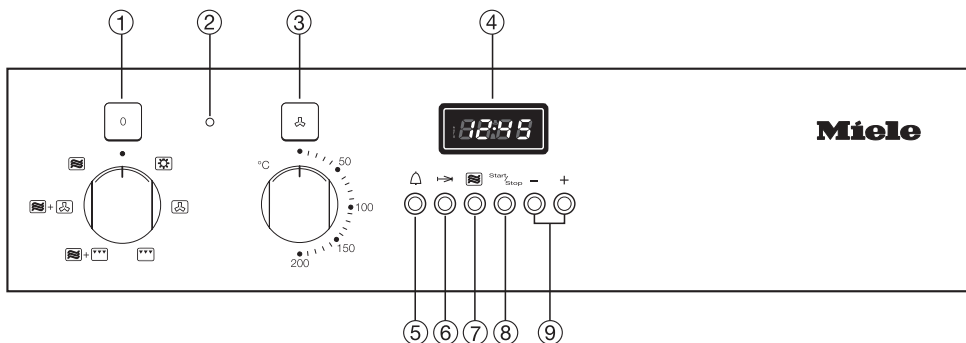

## Appliance

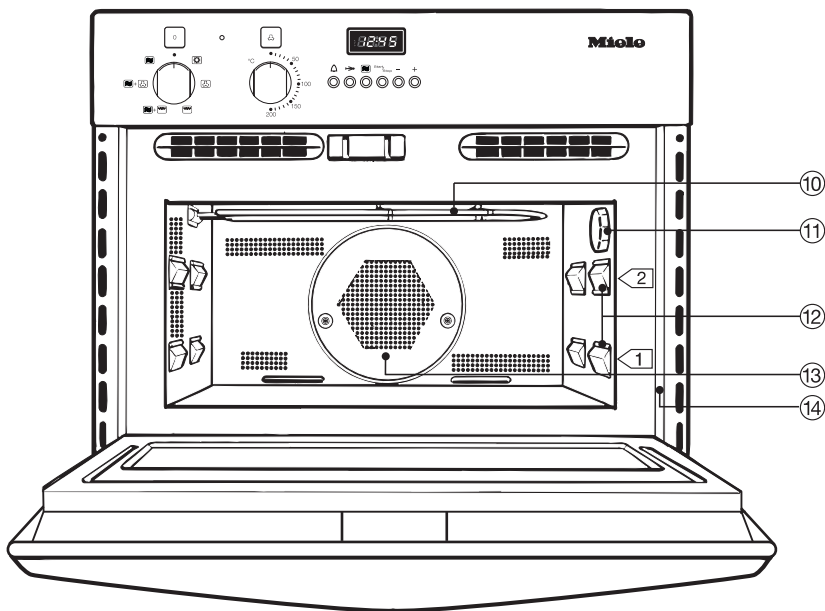

# Description of the appliance

## Control panel

- ① Function selector for:
  - Light ☒
  - Fan heat ☒
  - Grill ☒
  - Microwave + Grill ☒ + ☒
  - Microwave + Fan heat ☒ + ☒
  - Microwave mode ☒
- ② Indicator light for heating
- ③ Temperature selector for functions with Fan heat
- ④ Display
- ⑤ Minute minder button ⏰
- ⑥ Time entry button ⏪
- ⑦ Button ☒ for setting microwave power and time of day
- ⑧ Start/Stop button, to start and interrupt a process
- ⑨ "+/-" buttons to select microwave power level and time (Press and hold the button briefly to change in short steps, hold in for a longer time to change quickly)

## Appliance

- ⑩ Element
- ⑪ Oven interior lighting
- ⑫ First and second shelf supports
- ⑬ Air vent for the fan
- ⑭ Data plate

## Accessories

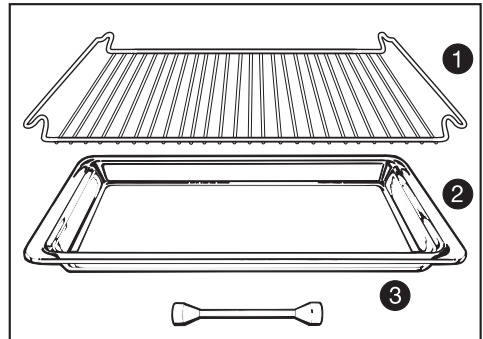

- ① Rack, ② Glass tray, ③ Boiling rod

## Special accessories





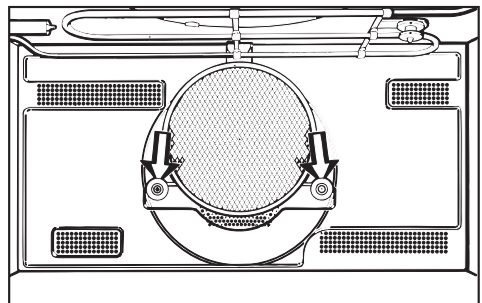

### Glass rear panel with grease filter (optional accessories)





A glass panel and grease filter can be inserted in the interior back wall. The grease filter will trap any excess droplets of fat keeping the oven interior and the area behind the rear wall cleaner when using the Fan heat system.



# Contents

---

<b>Description of the appliance</b> . . . . .	2
Accessories . . . . .	3
<b>Warning and Safety instructions</b> . . . . .	5
<b>Caring for the environment</b> . . . . .	11
<b>Operating modes</b> . . . . .	12
Microwave  . . . . .	12
Traditional oven functions . . . . .	13
Fan Heat  . . . . .	13
Grill  . . . . .	13
Combination programmes . . . . .	13
<b>Time of day</b> . . . . .	14
<b>Before using for the first time</b> . . . . .	15
<b>Suitable containers for microwave ovens</b> . . . . .	16
Material and shape . . . . .	16
<b>Using microwave mode</b> . . . . .	21
Deactivating the door lock before the end . . . . .	22
<b>Using traditional functions</b> . . . . .	23
Fan heat . . . . .	23
Switching on the timer . . . . .	23
Grill . . . . .	24
Switching on the timer . . . . .	24
<b>Using combination programmes</b> . . . . .	26
Microwave + Fan heat  +  . . . . .	26
Deactivating the door lock before the end . . . . .	27
Microwave + Grill  +  . . . . .	28
Deactivating the door lock before the end . . . . .	29
<b>Altering entered data</b> . . . . .	30
<b>Minute Minder</b> . . . . .	31
Altering a minute minder entry . . . . .	31
<b>Defrosting</b> . . . . .	32
Chart for defrosting food . . . . .	33
<b>Reheating</b> . . . . .	34
Chart for reheating food . . . . .	36

<b>Cooking</b> . . . . .	37
Fan Heat  . . . . .	37
Combination programmes . . . . .	38
Cooking chart . . . . .	39
Chart for cooking, browning and crisping food . . . . .	40
<b>Defrosting and Reheating / Cooking</b> . . . . .	41
Chart for defrosting and reheating or cooking of deep frozen ready made meals . . . . .	42
Defrosting and reheating, or cooking and crisping or browning of deep frozen ready made meals . . . . .	43
<b>Grilling</b> . . . . .	44
Preparation of meat or fish. . . . .	44
Test to see if cooked . . . . .	44
Chart for grilling . . . . .	45
<b>Baking</b> . . . . .	46
Fan Heat  . . . . .	46
Microwave + Fan Heat  +  . . . . .	46
Chart for baking . . . . .	48
<b>Cleaning and care</b> . . . . .	49
Appliance front and control panel . . . . .	49
Oven interior . . . . .	50
<b>Problem solving guide</b> . . . . .	53
<b>After sales service</b> . . . . .	55
Customer contact . . . . .	55
<b>Electrical connection IRL, U.K., ZA</b> . . . . .	56
<b>Electrical connection AUS, NZ</b> . . . . .	58
<b>Installation</b> . . . . .	59
Possibilities for installation and combination. . . . .	59
Installation measurements . . . . .	59

# Warning and Safety instructions

---

This appliance complies with all relevant legal safety requirements. Improper use of the appliance can, however, present a risk of both personal injury and material damage.

Before installation and before using the appliance for the first time, read the operating instructions carefully. They contain important notes on installation, safety, operation and care of the appliance. This way you will avoid the risk of accidents and damage to the appliance.

Keep these instructions in a safe place and pass them on to any future user.

## Correct usage

■ The appliance is intended for domestic use only: to cook food, and in particular to defrost, reheat, cook, bake, and to brown food. Any other usage is at the owner's risk and could be dangerous. The manufacturer cannot be held responsible for damage caused by improper use of the appliance.

Do not let children access the appliance or its controls. Supervise its use by the elderly or infirm.

If allowing older children to use the appliance without supervision please ensure that they are aware of how a microwave oven works and understand the dangers of improper use.

## Technical safety

■ If the connection cable is damaged the new cable must be fitted by a Miele approved service technician.

■ Do not use the microwave function of the appliance if

- the door is warped.

- the door hinges are loose.

- holes or cracks are visible in the casing, the door, the door seal or the oven interior walls.

Operating the appliance with this type of damage will result in microwave leakage, and present a hazard to the user.

■ Never open the casing of the appliance.

Tampering with electrical connections or components and mechanical parts is highly dangerous to the user and can cause operational faults or electric shock.

■ Before connecting the appliance to the mains supply make sure that the rating on the data plate corresponds to the voltage and frequency of the household supply. It is essential that these data correspond as otherwise damage will occur to the appliance. If in doubt consult a suitably qualified electrician.

■ Do not connect the appliance to the mains electricity supply by an extension lead. Extension leads do not guarantee the required safety of the appliance, (e.g. danger of overheating).

# Warning and Safety instructions

---

■ The electrical safety of this appliance can only be guaranteed when continuity is complete between the appliance and an effective earthing system, which complies with local and national regulations. It is most important that this basic safety requirement is tested by a qualified electrician. The manufacturer cannot be held responsible for the consequences of an inadequate earthing system, such as an electric shock.

■ This appliance must only be operated as a built-in appliance. This is necessary to ensure that all electrical components are shielded.

■ Installation work and repairs may only be carried out by a suitably qualified and competent service technician approved by Miele in accordance with local and national safety regulations. Repairs and other work by unqualified persons could be dangerous. The manufacturer cannot be held responsible for unauthorised work.

■ This equipment is not designed for maritime use or for use in mobile installations such as caravans, aircraft etc. However it may be suitable for such usage subject to a risk assessment of the installation being carried out by a suitably qualified engineer.

■ The appliance is only completely isolated from the electricity supply when:

- it is switched off at the wall socket, and the plug removed (where applicable). Do not pull on the cable, only on the plug.
- or the mains fuse is withdrawn
- or the screw-out fuse is removed (in countries where this is applicable)

Ensure that current is not supplied to the appliance while maintenance or repair work is being carried out.

## Use

### General notes

■ Always ensure that food is sufficiently cooked or reheated. Many factors will affect the overall cooking time, including the size and amount of food, its initial temperature, changes to recipe and the shape and size of cooking container. Some foods may contain micro organisms which are only destroyed by thorough cooking, therefore when cooking or reheating foods, e.g. poultry, it is particularly important that food is fully cooked through (at over 70°C, for a minimum of 10 minutes). If in doubt select a longer cooking or reheating time.

■ It is important that the heat is allowed to spread evenly throughout the food being cooked. This can be achieved by stirring and/or turning the food, and by observing a sufficiently long standing time, which should be added to the time needed for cooking, reheating or defrosting.

## Warning and Safety instructions

---

Always remember that cooking times in a microwave oven are usually considerably shorter than with traditional methods of food preparation. Excessively long cooking times can lead to food drying out and eventually burning, or could even cause it to catch fire. There is also a danger of fire if breadcrumbs, flowers, herbs, grains etc., are dried in the microwave oven. Always ensure that this type of procedure is supervised.

Exercise caution when cooking or reheating food with a high sugar content, e.g. Christmas pudding. If heated for too long the sugar may caramelize or ignite.

Do not use full power if you warm empty dishes or dry herbs. The lack or minimum amount of food could cause damage to the appliance.

Do not leave the oven unattended when cooking with oils and fats as these can be a fire hazard if allowed to overheat.

If smoke occurs in the oven, to avoid fuelling any flame do not open the oven door. Turn the function selector to "0", or switch off at the mains and remove the plug from the socket. Do not open the oven door until the smoke has dispersed.

Never heat undiluted alcohol in the microwave oven as this can easily ignite.

Do not heat up unopened tins of food in the oven as pressure will build up in the tin and it can explode. This could result in injury or damage.

Food left in the oven to take advantage of residual heat should always be covered to avoid it drying out, and to avoid a possible build-up of condensation which could adversely affect the oven interior.

Try to avoid the interior walls being splashed with food or liquids containing salt. If it does happen wipe these away thoroughly, to avoid corrosion on the stainless steel surface.

Wear oven gloves when removing the glass tray from the oven. If the glass tray has a heavy load, pull it only slightly towards you, and then hold firmly at the sides as you take it out.

The glass dish and the rack take a maximum load of 8 kg. Do not exceed this or the accessories may be damaged.

Do not lean or sit on the open oven door. This could damage the appliance. Take care in the region of the hinges. An oven door can support a maximum load of 8 kg.

When it is hot do not place the glass tray on a cold surface, such as a tile or granite worktop. It could break. Place it on a pot rest or a wire rack.

Under no circumstances use a steam cleaner to clean this appliance. The steam could attack the electrical components and cause a short circuit, or permanent damage to the surface and to components, for which the manufacturer of the oven cannot accept any responsibility.



## Warning and Safety instructions

Do not use the oven to heat up the room. Due to the high temperatures radiated, objects left near the oven could catch fire.

When using kitchen appliances connected to sockets near the oven ensure that the cable cannot get trapped in a hot oven door, which could melt the cable insulation and be dangerous.

In countries which may be subject to infestation by cockroaches or other vermin, pay particular attention to keeping the appliance and its surroundings in a clean condition at all times.

Any damage which might be caused by cockroaches or other vermin will not be covered by the appliance guarantee.

### Microwave function

Before serving remember to allow sufficient standing time and then always check the temperature of the actual food itself after taking it out of the oven. Do not be misled by the temperature of the container which does not necessarily give a correct indication of the temperature of the food or liquid in it. **This is particularly important when preparing food for babies, children, and the elderly or infirm.**

Never cook or reheat food or liquids in sealed containers or bottles. With baby bottles the screw top **and** teat must be removed. Otherwise pressure builds up which can cause the bottle or container to explode posing a severe risk of injury.

When heating liquids, the boiling rod provided should be placed into the container.



When heating liquids, milk, sauces etc., in the oven without the boiling rod, the boiling point of the liquid may be reached without the production of typical bubbles. The liquid does not boil evenly throughout. This so-called 'boiling delay' can cause a sudden build up of bubbles, when the container is removed from the oven or shaken. This can lead to the liquid boiling over suddenly and explosively. There is a danger of burning. The formation of bubbles can be so strong that the pressure forces the oven door open. The user could be injured and the appliance damaged.

The boiling rod ensures that the liquid boils evenly and that bubbles form at an early stage during the operation.

# Warning and Safety instructions

---

Do not use any containers or cutlery made from or containing metal, aluminium foil, lead crystal glassware, temperature-sensitive plastics, wooden utensils or cutlery, metal clips or wire ties. Such items could be damaged, or cause a fire hazard.

The rack supplied with the appliance is designed to be compatible with microwaves, and can therefore be used with or without the microwave function.

The rack gets hot when operating either the microwowave function or the browning element, or both. There is a danger of burning.

Eggs can only be cooked in their shells in the microwave oven in a specially designed egg-boiling device available from specialist shops. Similarly, hard-boiled eggs should not be reheated in the microwave oven as this may lead to the eggs bursting, even once they have been removed from the oven.

Eggs can be cooked without their shells in the microwave oven only if the yolk membrane has been punctured several times first. The pressure could otherwise cause the egg yolk to explode.

Do not reheat food in the oven in heat-retaining bags intended for normal ovens. These heat-retaining bags usually contain a thin layer of aluminium foil which reflects microwaves. This reflected energy can, in turn, cause the outer paper covering to become so hot that it ignites.

Food with a thick skin or peel, such as tomatoes, sausages, jacket potatoes, aubergines, should be pierced or cut in several places to allow steam to escape and prevent the food from bursting.

Ovenproof earthenware can retain a considerable amount of moisture. Earthenware and porcelain containers with hollow handles and lid knobs must only be used in this oven if they have vent holes, which allow the moisture to escape. Without vent holes there can be a pressure build-up, causing the container to crack or shatter, with the danger of injury.

## **Traditional oven functions: Fan Heat, Grill**

Caution - Danger of burning  
When the oven is being used as a traditional oven it can get very hot.

Great care should be taken to ensure that small children do not touch the oven when it is being used. External parts of the oven such as door glass, handle vents and the facia panel can become quite hot.

Wearing heat-resistant oven gloves is recommended when placing food in the oven, turning it or removing it. When the Grill function has been chosen, either solo or in a combination programme the element becomes very hot and there is a danger of burning.

## Warning and Safety instructions

---

- Wait until the element has cooled down before lowering it for cleaning.
- Do not use force to pull it down as this can cause the element to break.

### **Bottling**

Bottling should only be undertaken by an experienced cook who has received proper training in this method of preserving fruit and vegetables in an oven or microwave oven, and understands the implications of the chemical reactions involved.

The manufacturer cannot be held liable for damage caused by non-compliance with these Warning and safety instructions.

# Caring for the environment

---

## Disposal of the packing material

The transport and protective packing has been selected from materials which are environmentally friendly for disposal and can normally be recycled.

Ensure that any plastic wrappings, bags etc. are disposed of safely and kept out of the reach of babies and young children. Danger of suffocation!

Rather than just throwing these materials away, please ensure they are offered for recycling.

## Disposal of your old appliance

Old appliances may contain materials which can be reclaimed or recycled. Please contact your dealer, your local waste collection centre or scrap merchant about potential recycling schemes.

■ Before discarding an old appliance switch off and disconnect it from the power supply. This should be done by a competent person. Cut off and render any plug useless. Cut off the cable directly behind the appliance to prevent misuse.

Ensure that the appliance presents no danger to children while being stored for disposal.

## Microwave

Microwave cooking offers the benefits of speed, convenience and nutritional advantages when food does not require browning or crisping.

### Functional description

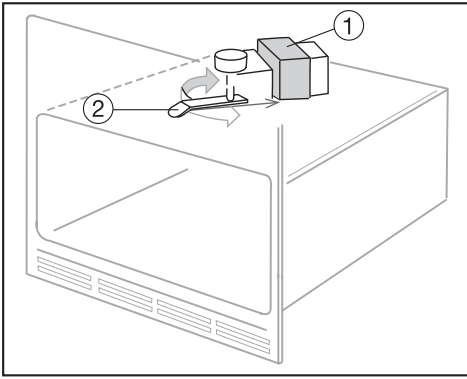

This oven is equipped with a magnetron ①, which converts electrical energy into microwaves.

A stirrer fan ② above the oven ceiling distributes the microwaves evenly throughout the oven interior, rebounding them off the walls so that they reach and enter the food from all sides.

In order for microwaves to reach the food, they must be able to penetrate the cooking utensil being used.

Microwaves can penetrate porcelain, glass, cardboard and plastics but not metal. Do not, therefore, use utensils made of metal, or which contain metal, for example in the form of gold or silver trim. The metal reflects the microwaves and this could lead to the creation of sparks. The microwaves cannot be absorbed.

All food contains moisture molecules which, when subjected to microwave energy, start to oscillate 2.5 thousand million times a second. The friction caused by this vibration creates heat, which first starts developing around the outside of the food and then slowly penetrates towards the centre. The moisture, fat and sugar content of food will affect the speed at which it is cooked.

As heat is produced directly in the food,

- food can generally be cooked without adding much liquid or cooking oil
- cooking, reheating and defrosting in a microwave oven is quicker than using traditional oven methods
- nutrients, such as vitamins and minerals, are generally retained
- colour, texture and taste of food are not impaired
- the surface temperature stays cool enough to avoid browning.

# Operating modes

---

## Traditional oven functions

Fan Heat 

Grill 

These cook and brown the food.

**Fan Heat** 

The fan circulates heat constantly around the oven, giving a very even temperature throughout.

It sucks in the air, heats it over a ring element and blows it back through the carefully spaced openings in the back panel.

As the heat is quickly transferred to the food, it is not usually necessary to pre-heat the oven, except when roasting sirloin or fillet or for foods such as puff pastry and yeast mixtures which require instant heat.

With Fan Heat food can be baked or roasted on both levels at the same time.



**Grill** 

Note that this function is best suited to browning food and for grilling very thin cuts of food.

As the element needs to radiate a high heat in order to cook the food, it will take several minutes after being switched on to glow red hot and so produce sufficient infra-red heat for grilling. Pre-heat the with the oven door closed for approx. 5 minutes before starting to cook.

## Combination programmes

Microwave + Fan Heat  + 

Microwave + Grill  + 

The combination programmes enable the grill or the fan setting to be used in conjunction with the microwave facility.

A microwave power level and cooking time are programmed together with either the grill or the fan to run simultaneously.

This enables cooking times to be reduced, yet a crisp, brown result can still be achieved without compromising the flavour or texture of the recipe.

In general when using combination programmes, you should not set the microwave power level higher than 150 W for baking, and not higher than 450 W for cooking and grilling.

After the appliance has been connected to the power supply or after a power cut **0•00** with **AUTO** on the left will flash in the display.



The time of day must be set before any other processes can be set.

### Setting time of day (24 hour clock)

Midnight (24 hours) is shown as **0•00**.

- Press the **→** and **☰** buttons at the same time.

The dot after the first figure in the display starts flashing. Whilst it is flashing, (approx. 4 seconds) set the time of day. It is shown in hours•minutes.

- Use the **+** or **-** button to enter the time of day.

After four seconds if no further entry is made, the oven display shows this time. The dot between the figures now stays on constantly to indicate that the time of day has been set.

## Before using for the first time

- Wipe out the oven interior with hot water and a little washing up liquid. Dry using a soft cloth.

Do not shut the oven door until the interior is completely dry, to avoid odours and the possibility of corrosion developing.

- Wash the accessories.

With new appliances there is usually a smell during the first use. It is dispelled more quickly by using a high temperature as follows:

Run the oven on the Fan Heat  setting for at least an hour:

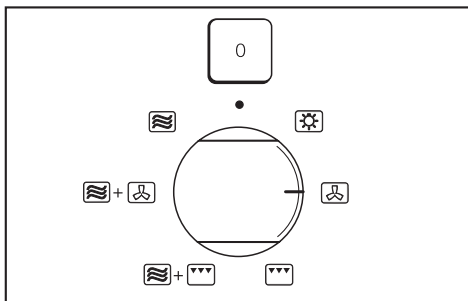

- Select Fan Heat  with the function selector.

The cooling fan starts up and the oven interior light comes on.

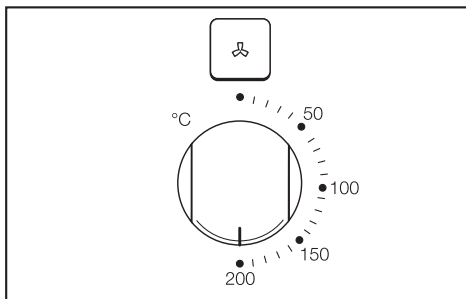

- Turn the temperature selector to 200 °C.

Only turn the temperature selector clockwise and then back again anti-clockwise. Do not force it past the resistance. Otherwise it could be damaged.

The oven begins to heat up. The indicator light on the control panel stays alight while the oven is heating up.

Ensure the room is well ventilated during this process.



# Suitable containers for microwave ovens

## Microwaves

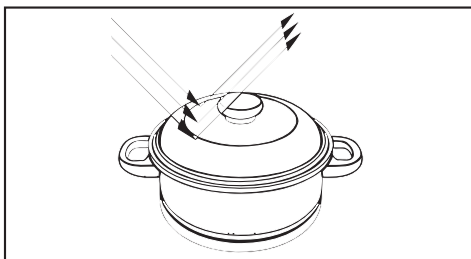

- are reflected by metal,

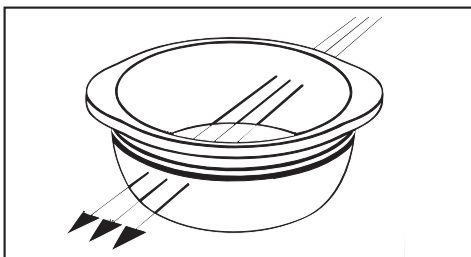

- pass through glass, chinaware, plastic and card,

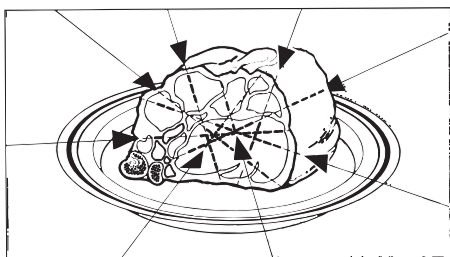

- and are absorbed by food.

## Material and shape

The material and shape of containers used affect cooking results and times. Heat distribution is more even in round and oval shaped dishes than in rectangular containers, providing better results.

## Metal

Metal containers, aluminium foil and metal cutlery, or china with metallic decoration such as gold rims or cobalt blue must not be used in microwave mode.

The metal reflects the microwaves, hindering the cooking process.

## Exceptions:

If recommended by the producer, pre-cooked meals packed in aluminium foil containers can be defrosted and reheated in the microwave oven. Important: remove the lid first. However, as food is only heated from the top, it is better to remove the food from the aluminium foil container and transfer it to a dish suitable for a microwave oven. The heat distribution will be more even. If sparks and arcing occur when using a metal container, stop and transfer the food to a microwave safe container.

For even defrosting and to avoid overcooking unevenly shaped cuts of meat, poultry or fish, small pieces of aluminium foil may be used to mask wing-tips or other thin parts for the last few minutes of the process.

# Suitable containers for microwave ovens

---

Make sure that the aluminium foil is at least 2 cm from the oven walls at all times. It must not touch the walls.

Metal meat skewers or clamps should only be used if they are very small in comparison to the size of the cut of meat.

The **rack** supplied with the appliance is suitable for use in a microwave oven. Do not place the rack on the oven floor.

The rack can get hot.

## Glassware

Heat-resistant glass or ceramic glass are ideal for use in the microwave oven.

Crystal glass contains lead which could cause the glass to crack. Glass dishes with a milled rim are subject to the same risk. Both are unsuitable.

## Earthenware

Although some ovenproof earthenware can be used in a microwave oven it may contain a considerable amount of moisture, causing it to become hot during use. It is normally advisable to avoid using it in a microwave oven.

Earthenware containers with hollow handles and lid knobs must only be used if they have vent holes, which allow the moisture to escape. Without vent holes there can be a pressure build-up, causing the container to crack or shatter, with the danger of injury.

Decorated earthenware is only suitable if the decoration is beneath an all-over glaze.

Earthenware can get very hot, and may crack.

## Porcelain (chinaware)

Porcelain is suitable, however containers with hollow handles and lid knobs must only be used if they have vent holes, which allow the moisture to escape. Without vent holes there can be a pressure build-up, causing the container to crack or shatter, with the danger of injury.

Do not use porcelain with gold or silver edging or items with hollow knobs or handles as insufficient ventilation may cause pressure.

## Glazes and colours

Some glazes and colours contain metal.

This makes them unsuitable for use in a microwave oven.

# Suitable containers for microwave ovens

---

## Plastics

Plastic containers must only be used for Microwave mode alone and not in conventional oven mode.

Plastics must be heat-resistant to a minimum of 180 °C. Otherwise the plastic may melt and fuse with the food.

Special plastic utensils, designed for use in microwave ovens are available from good retail outlets. Melamine ware is not suitable as it absorbs energy and heats up. When purchasing plasticware, make sure that it is suitable for use in a microwave oven.

Disposable containers, such as trays made from polystyrene, can only be used for very short timed warming and reheating of food.

Plastic boiling bags can be used for cooking and reheating. To reduce the risk of the bag bursting, they should be pierced first so that steam can escape and prevent a build-up of pressure.

## Roasting bags and -tubes

Roasting tubes should be about 40 cm longer and roasting bags about 20 cm longer than the food being roasted, and carefully tied with string. Turn the ends over and secure them. Holes should be made according to the manufacturer's instructions. Do not use metal clips or wire ties, even if bound by paper. There is a danger that they will ignite when heated.

## Wood

Wooden dishes are not suitable.

Moisture contained in the wood evaporates when exposed to microwave energy, causing the wood to dry and crack.

## Disposable containers

Only those plastic disposable containers which are specified by the manufacturer as suitable for use in a microwave oven may be used.

Do not leave the oven unattended when re-heating or cooking food in disposable containers made of plastic paper or other inflammable material.

Disposable containers are not always recyclable or degradable.

# Suitable containers for microwave ovens

## Testing dishes for their suitability

If in doubt as to whether glass, earthenware or porcelain plates or dishes are suitable for use in a microwave oven, a simple test can be performed:

- Place the item you wish to test in the centre of the oven, fill a suitable glass with water and also place this in the oven.
- Shut the door.

A microwave oven process cannot be started until the door is closed.

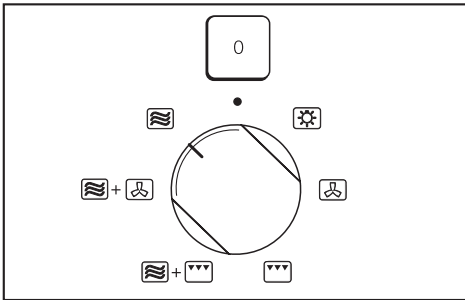

- Select Microwave  with the function selector. The cooling fan will run.



The display will show a suggested power level of 900 W.

- Press the  button.  
0•00 appears in the display for approx. 4 seconds.

While it is visible enter a time of 30 seconds with the "+" control.

The  symbol appears above the dot.

- Press the Start/Stop button.

The oven interior light comes on. The time entered counts down in the display in second steps. The  symbol stays on constantly.

If a crackling noise is heard accompanied by sparks during the test, switch off the appliance immediately. Turn the function selector to the "0" position. Any crockery which causes this reaction is unsuitable for use in the microwave oven.

At the end of this period a beep sounds three times and the  symbol flashes. Press any button to cancel them. The time of day reappears in the display and the oven interior light goes out.

The water in the glass should be warm, but the dish cool. If the dish is very hot and the water is cold, it would be unwise to use the dish.

If any doubt exists about the suitability of containers, please contact the supplier.

This test cannot be used to check whether items with hollow knobs or handles are suitable for use in a microwave oven.

# Suitable containers for microwave ovens

## A cover

- prevents too much steam escaping, especially when cooking food which needs longer to cook, such as potatoes,
- shortens and evens out the cooking process,
- prevents food from drying out,
- prevents any loss of aroma.

Sealed glass containers, such as jars of food, must be opened before they are placed in the oven.

## Do not use a cover if

- cooking meals which are to be given a crisp finish,
- cooking breaded or battered foods
- using a combination programme.

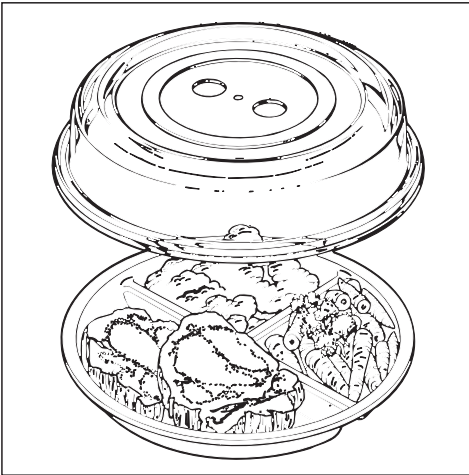

Always use lids or covers made of microwave-safe glass or plastic, or use a clingfilm recommended for use in a microwave oven, (pierce as instructed by the manufacturer). Unsuitable clingfilm can melt into the food.

# Using microwave mode

## Microwave

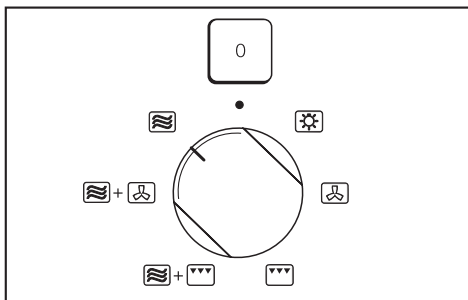

- Turn the function selector to microwave .

The cooling fan starts up.





The display will show a suggested power level of 900 W.

If this power level is not suitable alter it using the + or – button.

The following power levels can be selected:

80 W, 150 W, 300 W, 450 W, 600 W, 900 W.

Enter a time for the microwave process as follows:

- Press the  button.  
 appears in the display for approx. 4 seconds.
- Within these 4 seconds set the required time using the + or – button.

You can enter a maximum of 99 minutes 59 seconds.

With power level **900 W a maximum of only 30 minutes** can be entered.

The time entered appears in the display in minutes•seconds. The  symbol flashes above the dot.

Shut the oven door if it is still open. A microwave process can only start once the door is shut.



- Press the Start/Stop button to start the process.

The oven interior light comes on. The  symbol lights up constantly and the time entered begins to count down. The oven door is locked.

At the end of the time a beep sounds three times, and the  symbol flashes. Press any button to cancel them. The oven door is no longer locked. The oven light goes out. The time of day appears in the display.

# Using microwave mode

If the food is still not cooked, leave the function selector pointing to Microwave mode. Repeat the other steps in the following order:

- Press the  button.
- Set the required time with the + or – button.
- Press the  button.  
The display will show a suggested power level of 900 W.

The  symbol flashes above the dot.

- Press the + or – button within 4 seconds to enter the microwave power level required.
- Press the Start/Stop button.

## Deactivating the door lock before the end

To deactivate the door lock, you will have to interrupt the process.

- Press the Start/Stop button.

During the interruption the time goes on hold. The cooling fan continues to work and the  symbol flashes.

To continue the process:

- shut the oven door,
- and press the Start/Stop button.

The time proceeds again and the  symbol stays on constantly.

## Switching off the appliance

The cooling fan prevents the build-up of condensation in the warm appliance. Leave the cooling fan on until the oven has cooled down sufficiently.

- Turn the function selector and the temperature selector to "0". This will also turn off the cooling fan.

# Using traditional functions

The traditional oven functions can be used with or without the timer.

If you have set the timer for a specific time the appliance will heat during this time. At the end of the period a beep sounds three times and the appliance heating is switched off.

## Fan heat

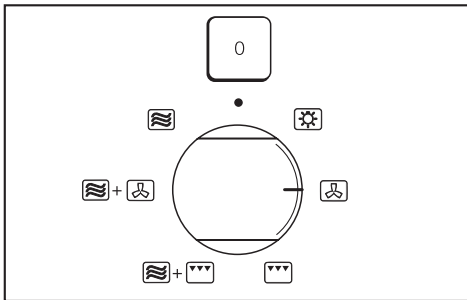

- Turn the function selector to Fan heat .

The cooling fan starts and the oven interior light comes on.

- Turn the temperature selector to the required temperature.

Only turn the temperature selector clockwise and then back again anti-clockwise. Do not force it past the resistance. Otherwise it could be damaged.

The appliance begins to heat up. The indicator light on the control panel stays on while the appliance is heating up.

## Switching on the timer

You can use the timer at any time to set the length of time for the fan heat to be on. At the end of this period the heating and the oven interior light switch off.

- Press the  button.  
*0•00* appears in the display for approx. 4 seconds.
- Within these 4 seconds use the + or – button to set the required time.

The oven interior light and the heating will go out as soon as you press the + or – button. At the left side of the display *AUTO* flashes.

You can enter a maximum of 99 minutes 59 seconds.



The time entered appears in the display in minutes•seconds.

- Press the Start/Stop button.

The oven light comes on and the oven begins to heat up. The indicator light on the control panel stays alight while the appliance heats up. The time entered counts down. The *AUTO* symbol stays on constantly at the left of the display.



# Using traditional functions

At the end of the time a beep sounds three times and the *AUTO* symbol flashes.

Press any button to cancel them. The heating and the oven lighting go out.

If the food is still not cooked:

- set a new time,
- and press the Start/Stop button.

## Switching off the appliance

The cooling fan prevents a build-up of condensation in the warm appliance. Leave the cooling fan on until the oven has cooled down sufficiently.

- Turn the function selector and the temperature selector to "0". This will also turn off the cooling fan.

## Grill

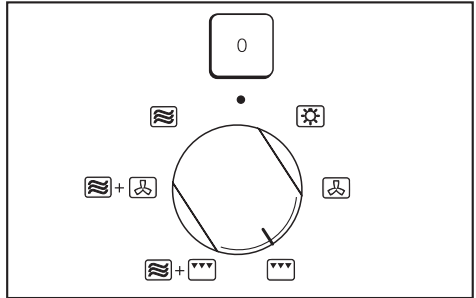

- Turn the function selector to Grill .

The cooling fan starts and the oven interior lighting comes on.

The grill temperature cannot be changed.

The element begins to heat up. The indicator light on the control panel stays on while the appliance is heating up.

## Switching on the timer

You can use the timer at any time to set the length of time for the grill to be on. At the end of this period the grill and the oven interior light switch off.

- Press the  button.  
*0•00* appears in the display for approx. 4 seconds.
- Within these 4 seconds use the + or – button to set the required time.

The oven interior light and the heating will go out as soon as you press the + or – button.

At the left side of the display *AUTO* flashes.

## Using traditional functions

---

You can enter a maximum of 99 minutes 59 seconds.



The time entered appears in the display in minutes•seconds.

- Press the Start/Stop button.

The oven light comes on and the grill begins to heat up. The indicator light on the control panel stays alight while the appliance heats up. The time entered counts down. The *AUTO* symbol stays on constantly at the left of the display.

At the end of the time a beep sounds three times and the *AUTO* symbol flashes.

Press any button to cancel them. The heating and the oven light go out.

If the food is still not cooked:

- set a new time,
- and press the Start/Stop button.

### Switching off the appliance

The cooling fan prevents a build-up of condensation in the warm appliance. Leave the cooling fan on until the oven has cooled down sufficiently.

- Turn the function selector to "0". This will also turn off the cooling fan.



## Using combination programmes

Microwave mode is combined with one of the traditional oven functions, (Fan heat or Grill).

A microwave process can only start if the door is shut.

### Microwave + Fan heat +

To use a combination programme you must first select a microwave power level and the time for the process.

- Turn the function selector to the combination programme :  
Microwave + Fan heat  + .

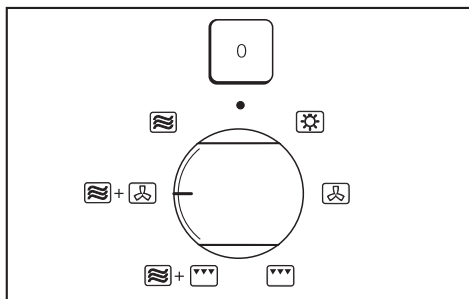

The cooling fan starts up.



The display will show a suggested power level of 300 W.

If this power level is not suitable alter it using the + or – button.

The following power levels can be selected:

80 W, 150 W, 300 W, 450 W.

To enter the time:

- Press the g button.  
**0•00** appears in the display for approx. 4 seconds .
- Within these 4 seconds set the required time using the + or – button.

You can enter a maximum of 99 minutes 59 seconds.

With power level **450 W a maximum of 60 minutes** can be entered.

The time entered appears in the display in minutes•seconds. The  and *AUTO* symbols flash.

- With the temperature selector choose a temperature for the Fan heat function.

Only turn the temperature selector clockwise and then back again anti-clockwise. Do not force it past the resistance. Otherwise it could be damaged.

- Press the Start/Stop button.

The oven interior light comes on. The microwave function starts and the oven begins to heat. The indicator light on the control panel stays alight while the oven is heating up.

## Using combination programmes

---

The  and *AUTO* symbols stay on constantly and the time entered counts down. The oven door is locked.

At the end of the set time the microwave function, the heating and the oven interior light switch off. A beep sounds three times and the symbols flash. Press any button to cancel them. The oven door is no longer locked. The time of day appears in the display.

If the food is still not cooked, the function selector can be left pointing to Microwave + Fan. Repeat the other steps in the following order:

- Press the  button.
- Set the required time with the + or – button.

The *AUTO* symbol flashes.

- Press the  button.  
The display shows a suggested power level of 300 W.

The  symbol also flashes above the dot.

- Press the + or – button within 4 seconds to enter the microwave power level required.
- Press the Start/Stop button.

The period of time set appears in the display.

### Deactivating the door lock before the end

To deactivate the door lock, you have to interrupt the process.

- Press the Start/Stop button.

During the interruption the time goes on hold. The cooling fan continues to run, the oven light goes out, and the symbols flash.

To continue the process:

- shut the oven door,
- and press the Start/Stop button.

The oven light comes on again and the symbols light up constantly.

### Switching off the appliance

The cooling fan prevents a build-up of condensation in the warm appliance. Leave the cooling fan on until the oven has cooled down sufficiently.



- Turn the function selector and the temperature selector to "0". This will also turn off the cooling fan.

## Using combination programmes

### Microwave + Grill +

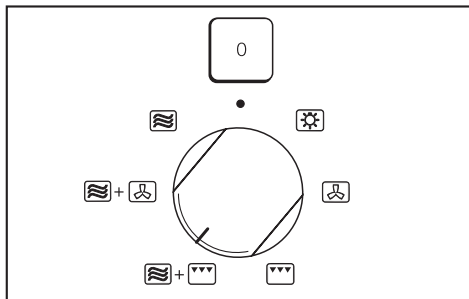
Before starting the combination programme you must first select the microwave power level and the time for the process.



- Turn the function selector to the combination programme Microwave + Grill  + 

The cooling fan starts up.





The display shows a suggested power level of 300 W.

If this power level is not suitable alter it using the + or – button.

The following power levels can be selected:

80 W, 150 W, 300 W, 450 W.

To enter the time:

- Press the  button.  
 appears in the display for approx. 4 seconds .
- Within these 4 seconds set the required time using the + or – button.

You can enter a maximum of 99 minutes 59 seconds.

With power level **450 W a maximum of 60 minutes** can be entered.

The time entered appears in the display in minutes•seconds. The  and *AUTO* symbols flash.

The grill temperature cannot be altered.

- Press the Start/Stop button.

The oven interior light comes on. The microwave function starts and the grill begins to heat. The indicator light on the control panel stays alight while the oven is heating up.

The  and *AUTO* symbols stay on constantly and the time entered counts down. The oven door is locked.

At the end of the set time the microwave function, the grill and the oven interior light switch off automatically. A beep sounds three times and the symbols flash. Press any button to cancel them. The oven door is no longer locked. The time of day appears in the display.

## Using combination programmes

---

If the food is still not cooked, leave the function selector pointing to Microwave + Grill and repeat the other steps in the following order:

- Press the  button.
- Set the required time with the + or – button.

The *AUTO* symbol flashes.

- Press the  button.  
The display shows a suggested power level of 300 W.

The  symbol also flashes above the dot.

- Press the + or – button within 4 seconds to enter the microwave power level required.
- Press the Start/Stop button.

The period of time set appears in the display.

### Deactivating the door lock before the end

To deactivate the door lock, you have to interrupt the process.

- Press the Start/Stop button.

During the interruption the time goes on hold. The cooling fan continues to run, the oven light goes out, and the symbols flash.

To continue the process:

- shut the oven door,
- and press the Start/Stop button.

The oven light comes on again and the symbols light up constantly.

### Switching off the appliance

The cooling fan prevents a build-up of condensation in the warm appliance. Leave the cooling fan on until the oven has cooled down sufficiently.

- Turn the function selector to "0". This will also turn off the cooling fan.

## Before starting a process

If you discover before the start of a process that you have made an error with the data entry then this can be corrected.

### Changing a time entry

- Press the  button to activate the time function.
- Press the + or – button to enter a new time.
- Press the Start/Stop button to start the process.

### Changing the microwave power level

- Press the  button to activate the microwave function.
- Press the + or – button to enter a new microwave power level.
- Press the Start/Stop button to start the process.

## After starting a process

If you discover after the process has begun that you have made an error with the data entry, press the Start/Stop button to interrupt the process.

The time is halted at the point of interruption.

The cooling fan continues to run during this period.

Correct the time and microwave power level entry as described in the Section "Before starting a process".

- Press the Start/Stop button once again to re-start the process

## Minute Minder

You can set the minute minder to time other activities in the kitchen, e.g. boiling eggs on a hob. You can also set the minute minder after a process has started.

- Press the  $\Delta$  button.



$0:00$  (hours•minutes) shows in the display and the symbol  $\Delta$  appears under the dot.

- Within 4 seconds use the + or - button to set the time required.

The minute minder option allows you to enter a time between 1 minute and 24 hours.

After a short delay the time of day or the time set for the process under way shows in the display field.

The minute minder time starts automatically. **Do not** press the Start/Stop button.

The time is not shown counting down, but to see it you can press the  $\Delta$  button. It counts down in minutes.

Once the minute minder has counted down to one minute the time remaining counts down in the display in seconds.

### Altering a minute minder entry

If you have entered a wrong time, this can be corrected.

You cannot change the time set if the timer is counting down in seconds (i.e. during the last minute). If the + or – button is pressed the display changes to  $0:00$ , followed by the time of day.

- Press the  $\Delta$  button.
- Use the + or – button to correct the time.

### When the minute minder time is completed

- A beep will sound three times. The  $\Delta$  symbol flashes. Press any button to cancel them.

### Cancelling a minute minder time

- Press the  $\Delta$  button.
- Press the + and – buttons at the same time.  
The minute minder time is set to  $0:00$  in the display.  
The time of day or the time for a process already started will reappear in the display.



The microwave function can be used to defrost food gently and quickly.

The following settings are recommended as a general guide:

- 150 W  
for defrosting quite delicate food e.g. milk, cake etc.
- 80 W  
for defrosting very delicate food e.g. cream, butter, gateau and cheese.
- Remove the food from its packaging and place it in a microwave-safe container.
- Place the container in the middle of the oven floor.

If defrosting a large quantity, e.g. 2 kg of fish, you can also use the glass tray as a container. Place the glass tray on the oven floor.

Turn, stir or separate the food about half-way through the defrosting time.

## After defrosting

Allow the food to stand at room temperature long enough to allow the temperature to spread evenly throughout the food.

For more detailed information on defrosting consult a good microwave or microwave combi-oven cookbook.

# Defrosting

## Chart for defrosting food

	Quantity	"150 W" Time in mins.	"80 W"	standing time at room temperature * in mins.
<b>Dairy products</b>				
Cream	1/4 l	–	15 – 20	10 – 15
Butter	250 g	–	8 – 10	5 – 10
Cheese slices	250 g	–	6 – 8	10 – 15
Milk	1/2 l	12 – 14	–	10 – 15
Quark (Cream cheese)	250 g	10 – 12	–	10 – 15
<b>Cakes / Pastry / Bread</b>				
Sponge cake	1 slice ca. 100 g	1 – 2	–	5 – 10
Sponge cake	300 g	4 – 6	–	5 – 10
Fruit cake	3 pieces ca. 300 g	6 – 8	–	10 – 15
Queen cakes	3 pieces ca. 300 g	5 – 7	–	5 – 10
Cream cake	1 piece ca. 100 g	–	1 1/2 – 2	5 – 10
Yeast buns	4 rolls	6 – 8	–	5 – 10
Bread rolls	1 roll ca. 50 g	1 1/2 – 2	–	5 – 10
Bread rolls	4 rolls ca. 200 g	4 – 6	–	5 – 10
Sliced bread	1 slice	1/2 – 1	–	3 – 4
<b>Fruit</b>				
Strawberries, Raspberries	250 g	7 – 8	–	5 – 10
Blackcurrants	250 g	8 – 9	–	5 – 10
Plums	500 g	12 – 16	–	5 – 10
<b>Meat</b>				
Minced beef	500 g	18 – 20	–	5 – 10
Chicken	1000 g	36 – 38	–	10 – 15
<b>Vegetables</b>				
Peas	250 g	10 – 14	–	5 – 10
Asparagus	250 g	10 – 14	–	10 – 15
Beans	500 g	15 – 20	–	10 – 15
Red cabbage	500 g	15 – 20	–	10 – 15
Spinach	300 g	14 – 16	–	10 – 15

\* During this time the temperature spreads evenly through the food.

**The information given in this chart is intended only as a guide. Consult a good microwave / microwave combi-oven cookbook for further details on defrosting these and other foods**

The microwave function  can be used to reheat food.

Select the following microwave power settings to reheat food

- drinks 900 W,
- food 900 W or 600 W
- \* food for babies 450 W.

### \* **Baby food**

We do not recommend heating or reheating foods or drinks for babies or young children in the microwave oven. Any decision to do this is the responsibility of the user, and should only be done with the utmost care.

Always remove the lids from jars, especially jars of baby food. Remove the rubber teat and seal top before warming baby bottles.

Pasteurised or sterilised cooked food should be gently heated at 450 watts, and tasted so that it is not too hot for a baby's palate before serving. Other food or drink when reheated should be heated to a high temperature and allowed to cool to a suitable heat for consumption. For made-up milk follow the manufacturer's instructions.

After reheating stir the food or shake the container and check that the temperature does not pose any danger. Double check after it has been left to stand.

Always use a lid or cover for reheating food, except when a drier finish is needed, e.g. breaded poultry / meat.

When reheating liquids place the boiling rod supplied into the cup or glass.

Never reheat hard boiled eggs in a microwave oven, even without the shell. The eggs can burst.

Do not reheat food in the oven in heat-retaining bags intended for normal ovens. These usually contain a thin layer of aluminium foil which reflects microwaves. This reflected energy can cause the outer paper covering to become so hot that it ignites.

The time required depends largely on the nature of the food, its initial temperature and the amount to be cooked. Food taken straight from the refrigerator takes longer to reheat than food stored at room temperature.

Always ensure that the food is adequately heated.

If in any doubt that a sufficiently high temperature has been reached, continue reheating for a little longer.

Stir or turn food from time to time during cooking. Stir the food from the outside towards the middle, as food heats more quickly from the outside.

# Reheating

---

## After re-heating

Be careful when removing a dish from the oven. It may be hot.

For more detailed information on re-heating consult a good microwave or microwave combi-oven cookbook.

Although heat is not normally produced in the container itself by the microwaves, (apart from stoneware and similar dishes), heat transfer from the food to the container may be considerable, making the container itself hot.

Allow food to stand for a few minutes at room temperature once a programme has ended to allow heat to be distributed evenly.

After reheating food, especially food for babies and small children, stir the food or shake the container and check that the temperature does not pose any danger. Double check after it has been left to stand.

## Chart for reheating food

Drinks **	Quantity	Microwave setting		Standing time at room temperature * in mins.
		900 W Time in mins.	450 W Time in mins.	
Coffee, drinking temp 60 – 65 °C	1 cup, 0.2 l	1 – 1 <sup>1</sup> / <sub>2</sub>	–	–
Milk, drinking temp 60 – 65 °C	1 cup, 0.2 l	1 – 1 <sup>1</sup> / <sub>2</sub> ***	–	–
Water to the boil	1 cup, <sup>1</sup> / <sub>8</sub> l	1 – 1 <sup>1</sup> / <sub>2</sub>	–	–
Baby bottle (Milk) !!	approx. 200 ccm	–	<sup>1</sup> / <sub>2</sub> – 1***	1
Mulled wine, Grog drinking temp. 60 – 65 °C	1 glass, 0.2 l	1 – 1 <sup>1</sup> / <sub>2</sub>	–	–

Food ***	Quantity	Microwave setting		Standing time at room temperature * in mins.
		600 W Time in mins.	450 W Time in mins.	
Baby food (!!)	1 jar, 200 g	–	<sup>1</sup> / <sub>2</sub> – 1	1
Soup	<sup>1</sup> / <sub>4</sub> l	4 – 5	–	1
	<sup>1</sup> / <sub>2</sub> l	7 – 8	–	2
Casserole	250 g	4 – 5	–	2
	500 g	7 – 8	–	3
	1000 g	10 – 12	–	3
Plated meals	1 portion, 400 g	5 – 7	–	2
	2 portions, 800 g	10 – 12	–	3
Vegetables	250 g	3 – 4	–	2
	500 g	5 – 6	–	3
Meat	200 g	3 – 5	–	2
	500 g	7 – 9	–	3
Frankfurters in <sup>1</sup> / <sub>4</sub> l water	100 g	3 – 4	–	1
Cutlet, fried	200 g	3 – 5	–	2
Fish fillet, fried	200 g	3 – 4	–	2
Rösti, Hash browns	250 g	3 – 5	–	1
Gravy	<sup>1</sup> / <sub>4</sub> l	4 – 5	–	1
Hollandaise sauce	<sup>1</sup> / <sub>4</sub> l	–	3***	1

!! See Warning in Section on Reheating.

\* During this time the temperature spreads evenly through the food.

\*\* Put the boiling rod in the container.

\*\*\* Times are based on an initial temperature of approx 5 °C.

For food not normally stored in a fridge an initial temperature of 20 °C is assumed.

All food except delicate sauces should be reheated to 70 – 75 °C. Temperature should be tested for palatability before serving to invalids or the elderly. See note on food and drink for babies.

**\*\*\*\* Consult a good microwave / microwave combi-oven cookbook for further details on reheating these and other foods.**

**The information given in this chart is intended only as a guide.**

# Cooking

---

Microwave, traditional and combination programmes are all suitable for cooking.

## Microwave

This method is suitable for cooking noodles, pasta, rice, semolina pudding etc.

First select 900 W and then turn down to 450 W to continue cooking, or 150 W for simmering.

Place the food in a microwave-safe dish and cover it.

Place the dish on the oven floor.

Vegetable cooking times depend on the texture of the vegetable. Fresh vegetables contain more water than vegetables which have been stored and usually cook more quickly. Add a little water to vegetables which have been kept stored. Stir and turn food at least once during cooking.

Food with a thick skin or peel, such as tomatoes, sausages, jacket potatoes and aubergines, should be pierced or cut in several places to allow steam to escape and prevent the food from bursting.

Eggs can only be cooked in their shells in the microwave oven in a specially designed egg-boiling device available from specialist shops. Similarly, hard-boiled eggs should not be reheated in the microwave oven as this may lead to the eggs bursting, even once they have been removed from the oven.

Eggs can be cooked without their shells in the microwave oven only if the yolk membrane has been punctured several times first. The pressure could otherwise cause the egg yolk to explode.

## Fan Heat

This method is recommended for everyday cooking, e.g. cakes, pastry, mergues, pizza, potatoes and other vegetables.

Slide the glass tray with the rack into the lowest runner level.

The following containers are suitable:

Ovenproof china or glassware, earthenware, pans with heat resistant handles.

Cover foods such as potatoes or vegetables which are to be simmered or poached, to avoid them drying out.

Where a crisp finish is required e.g. for meat, cook without a lid.

## Combination programmes

### **Microwave + Fan Heat** +

is suitable if you want a shorter cooking time.

### **Microwave + Grill** +

is suitable for cooking food which requires a crisp finish or browning.

Place the cooking container on the glass tray and slide into the lowest runner level.

Only use heat-resistant, microwave-safe crockery. No metal.

Cover food being cooked in the Microwave + Fan Heat combination to avoid it drying out.

Leave food being cooked in the Microwave + Grill combination uncovered so that it can brown.

Ensure that food, such as meat and fish, are cooked for an appropriate length of time.

For more detailed information on cooking consult a good microwave or microwave combi-oven cookbook.

# Cooking

## Cooking chart

	Quantity	Microwave setting 900 W + 450 W		Standing time at room temp. * in mins.	
		Time in mins.	Time in mins.		
<b>Meat</b>					
Goulash (with 750 g of meat)		6	+	24 – 26	3 – 5
Liver	200 g	3		–	–
<b>Poultry</b>					
Chicken in wine sauce	approx. 900 g	3	+	13 – 18	5 – 8
Chicken in curry sauce	approx. 800 g	4	+	6 – 8	3 – 5
<b>Fish</b>					
Fillet in sauce	500 g	3	+	4 – 9	2 – 3
Trout, blue	2 pcs. each 250 g	4	+	5 – 6	2 – 3
<b>Fresh vegetables</b>					
Carrots	300 g	2	+	6	2
Cauliflower florets	500 g	5	+	10	2
Peas, Spinach	500 g	3	+	10	2
Pepper (strips)	500 g	5	+	10	2
Kohlrabi batons, beans	500 g	3	+	10	2
Brussel sprouts	500 g	5	+	9	2
Asparagus	500 g	5	+	9	2
Broccoli florets	300 g	2	+	4	2
Leeks	500 g	3	+	9	2
Fennel	500 g	3	+	10	2
<b>Frozen vegetables</b>					
Peas, Mixed veg.	450 g	5	+	11	2
Spinach	450 g	5	+	7	2
Brussel sprouts	300 g	4	+	6	2
Broccoli	300 g	3	+	6	2
Leeks	450 g	4	+	8	2
<b>Desserts</b>					
Baked apples	2	3		–	–
Apples in wine sauce	4	5		–	–
Cream of apricot pudding	1/2 l	4 – 5		–	–
Vanilla pudding	1/2 l	5 – 6		–	–

\* During this time the temperature spreads evenly through the food.

**The information given in this chart is intended only as a guide.**



## Chart for cooking, browning and crisping food

	Pre-cook * Microwave		Cook + Brown, Crisp Microwave + Grill	
	900 W Time in mins.	+	Microwave setting in W	Time in mins.
Paprika boats <sup>1)</sup>	3	+	450	10 – 12
Root veg.-Lasagne <sup>1)</sup>	4	+	450	22 – 24
Emmental-Noodles <sup>2)</sup>	–		450	8 – 12**
Vegetable Burger <sup>3)</sup>	4	+	450	28 – 30
Potato Dauphinoise <sup>3)</sup>	–		450	25 – 27
Breaded fish <sup>1)</sup>	–		450	8 – 12**
Fish in Cheese Sauce <sup>1)</sup>	–		450	14 – 18**

### Microwave + Grill

	Quantity	Microwave setting in W	Time in mins.
<b>Meat <sup>1)</sup></b>			
Ham	1000 g	300	45 – 50
Beef	500 g	300	20 – 25
Lamb	750 g	300	30 – 35
Meat loaf	750 g	450	25 – 30
<b>Poultry <sup>1)</sup></b>			
Chicken, half	1000 g	150	28 – 30
Boned turkey roll	1000 g	450	44 – 48
<b>Snacks <sup>2)</sup></b>			
Tuna on toast	2 pcs	450	3 – 4**
Tuna on toast	4 pcs	450	5 – 6**
Sausage wrapped in cheese and ham	4 pcs	450	5 – 6**

\* Pre-cook vegetables / sauce or fillings with lid on

\*\* Pre-heat grill for approx.5 minutes, place food on the rack

1) First shelf level from bottom

2) Second shelf level from bottom

3) Oven floor

Slide the glass tray with the rack in at the appropriate shelf level.

**Allow a standing time at room temperature of:**

approx. 5 minutes, and 2 minutes or more for cooking times under 10 minutes.

**Consult the cookbook supplied with your oven and/or a good microwave / microwave combi-oven cookbook for further details on cooking these and other foods.**

**The information given in this chart is intended only as a guide.**

## Defrosting and Reheating / Cooking

---

For simultaneous defrosting and reheating or cooking the following functions are suitable:

### Microwave

This method is suitable for defrosting and then reheating or cooking deep frozen ready made meals which you do not wish to brown.

Deep frozen ready made meals can be defrosted and immediately reheated or cooked in the same process, selecting 900 W and then 450 W.

Remove the food from its packaging and place in a covered microwave-safe dish for defrosting and reheating or cooking. Exception: Minced meat should be left uncovered while cooking. Soups, stew and vegetables should be stirred several times during the process. Separate slices of meat half-way through the programme. Turn pieces of meat and fish at the half-way stage.

Deep-frozen ready made meals in cardboard trays which, according to manufacturer's instructions, are suitable for use in a normal oven, are microwave-safe.

### Microwave + Grill +

This method is suitable for defrosting and then reheating or cooking deep frozen ready made meals, which are to be crisped and browned. Microwave output is limited to 450 watts when used with the grill.

For deep-frozen pre-cooked meals which are to be crisped and browned, the Microwave + Grill combination can be selected. Select microwave power 450 watts. The grill temperature cannot be altered.

Put the ready made meal in a heat resistant, microwave-proof dish, and place on the glass tray. Slide the tray into the 2nd level. Do not cover.

Ready made meals in aluminium dishes can be placed directly on to the glass tray. If this does not brown the food as much as you would like, next time put the dish on the rack, and slide this together with the glass tray into the first level from the bottom.

For more detailed information on defrosting followed by reheating or cooking consult a good microwave or microwave combi-oven cookbook.

# Defrosting and Reheating / Cooking

## Chart for defrosting and reheating or cooking of deep frozen ready made meals

	Quantity	Microwave setting		Standing time at room temperature* in mins.	
		900 W Time in mins.	+ 450 W Time in mins.		
<b>Soup</b>					
Cream soups	0.75 l	7	+	8 – 10	2
Clear beef broth with vegetables	0.8 l	8	+	10 – 12	2
<b>Fish</b>					
White fillet	400 g	4	+	10 – 12	2
Sea trout in herb sauce	400 g	3	+	10 – 12	2
<b>Meat</b>					
Burgers	160 g	3		–	1
Roast	450 g	3	+	7 – 8	1
Goulash	250 g	3	+	5 – 6	1
Dumplings	450 g	3	+	6 – 7	2
Chicken fricassé	450 g	3	+	7 – 8	2
<b>Vegetables</b>					
Puree	450 g	4	+	7 – 8	2
Vegetable casserole + 1/8 l Water	400 g	5	+	6 – 7	3
<b>Rice, Noodles, Plated meals</b>					
Paella + 0.1 l Water	400 g	6 – 7		–	2
Tortellini + 0.2 l Milk / water	450 g	5	+	4 – 5	2
Lasagne	420 g	3	+	10 – 12	2

\* During this time the temperature spreads evenly through the food.

**Consult a good microwave / microwave combi-oven cookbook for further details on defrosting and reheating or cooking these and other foods.**

**The information given in this chart is intended only as a guide.**

## Defrosting and Reheating / Cooking

### Defrosting and reheating, or cooking and crisping or browning of deep frozen ready made meals

	Quantity	combined operating Microwave + Grill		Standing time at room temperature * in mins.
		Microwave- setting in W	Time in mins.	
Bistro Baguettes	250 g	450	8 – 10	2
Lasagne	450 g	450	14 – 16	2
Potatoes, broccoli and ham in sauce	350 g	450	14 – 16	2
Wholemeal pasta bake with vegetables and ham	350 g	450	16 – 18	2
Fish fillet	450 g	450	18 – 20	2
2 spiced burgers	250 g	450	8 – 10	2

\* During this time the temperature spreads evenly through the food.

Ready made meals in heat resistant dishes suitable for microwaving.

Ready made meals in aluminium containers can be put directly onto the glass tray. Remove the cover.

Slide the glass tray into the second shelf level

**Consult a good microwave / microwave combi-oven cookbook for further details on defrosting and reheating or cooking these and other foods.**

**The information given in this chart is intended only as a guide.**

The following grill settings are suitable for browning food:

**Grill** ☞ is suitable for browning dishes such as cauliflower cheese. It can be used for grilling very thin meat or fish.

**Microwave + Grill** ☞ + ☞ is suitable for cooking food which requires a crisp finish or browning. The microwave power output is limited to 450 W with this setting.

## Preparation of meat or fish

Clean, wipe and season. Do not salt slices of meat beforehand as this draws the juices out.

Add a little oil if necessary. Other fats quickly become black or cause the food to smoke. A little butter can be added to chicken if desired.

Clean flat fish and slices of fish in the normal way. To enhance the taste add a little salt or squeeze a little lemon juice over the fish.

**Pre-heat** the grill for approx. 5 minutes with the oven door shut. Do not select a microwave setting.

**Brush the rack with oil** and place the prepared food on the rack.

It is best to grill food of a similar thickness at the same time so that the grilling time for each item does not vary too greatly.

Slide the glass tray with the rack

- into the upper (2nd) runner level for flat pieces of food
- into the lowest runner level for thicker pieces of food

Most items should be turned half way through cooking.

## Test to see if cooked

One way of finding out how far through a piece of meat has been cooked is to press down on it with a spoon:

- If there is very little resistance to the pressure of the spoon, it is still red on the inside ("rare").
- If there is some resistance the inside will be pink ("medium").
- If there is great resistance, it is thoroughly cooked through ("well done").

For more detailed information on grilling consult a good microwave or microwave combi-oven cookbook.

# Grilling

---

## Chart for grilling

Pre-heat the grill for approx five minutes.

<b>Flat items <sup>1)</sup></b>	<b>total Grill time in mins. <sup>2)</sup></b>
Steaks	25 – 30
Burgers	30 – 35
Sausage	20 – 25
Fish fillet	16 – 20
Toast	2 – 4
Toast with topping	5 – 7
Tomatoes	8 – 10
Peaches	7 – 10

1) upper runner level

2) Turn the food half way through grilling.

~~The information given in the chart is intended only as a guide. Look for further details on grilling these and other foods.~~

## Fan Heat

This method is suitable for baking small cakes, swiss roll, pastry doughs.

Most types of heat-resistant tins or dishes are suitable, including thin-walled and bright, non-reflective metal tins.

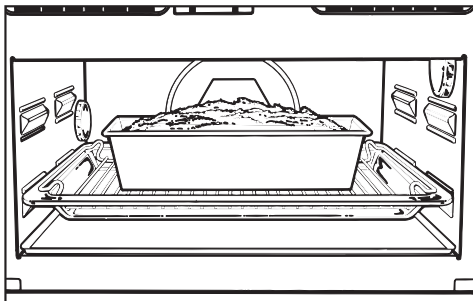

Slide the glass tray with the rack into the 1st runner from the bottom, and place the baking tin on this.

Do not push the glass tray right to the back wall, but leave a gap of about 2 cm. Otherwise browning will be uneven.

Baking time should not be too long. This can lead to the cake etc. drying out.

Increasing the temperature from suggested levels and reducing the time can have an adverse effect on browning. To achieve even browning it might be better to select a slightly longer cooking time at a slightly lower temperature.

## Microwave + Fan Heat +

This combination programme is suitable for doughs which require longer baking, such as rubbed in and beaten mixtures, yeast recipes and cheese-cake.

For preference use ovenproof glass or ceramic baking dishes, as microwaves can penetrate these materials into the food being cooked. Metal tins would reflect microwaves, so that they would only reach the cakes from the top, resulting in a longer cooking time.

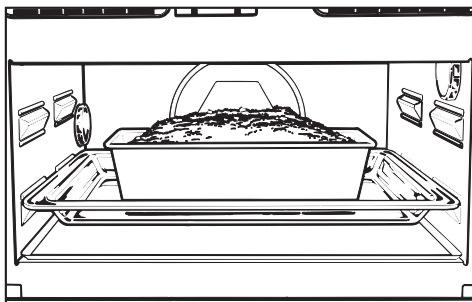

Slide the glass tray into the 1st runner from the bottom, and place the baking dish on this.

Do not push the glass tray right to the back wall, but leave a gap of about 2 cm. Otherwise browning will be uneven.

# Baking

---

With metal baking tins there may be sparking. Try positioning the tin differently on the glass tray, and make sure the tin does not touch the interior walls.

If sparking continues, do not use this tin again in microwave combination mode.

Do not use paper based containers coated with aluminium foil, such as are sometimes provided with packet cake mixes. There is the danger of these catching fire.

Switch on the microwave setting for the total cooking time. The microwave setting should not be higher than 150 W.

Temperature settings, times and microwave power settings in the Baking Chart are suggestions only. Select an average temperature and time for first attempts and adapt accordingly.

If the grease filter is in position in front of the fan grille opening this lengthens baking time.

At the end of the shorter time given, check to see whether the cake etc. is done. Insert a wooden or metal skewer in the centre. If it comes out clean without dough sticking to it, the cake is ready.

For more detailed information on baking consult a good microwave or microwave combi-oven cookbook.



## Chart for baking

	Fan Heat		Microwave + Fan Heat		
	Temp. in °C	Time in mins.	Microwave setting in W	Temp. in °C	Time in mins.
<b>Creamed mixture</b>					
Victoria sandwich	160 – 165	20 – 25	–	–	–
Farmhouse fruit cake	–	–	150	130	60 – 70
Nut cake (glass tray) <sup>1)</sup>	150 – 170	25 – 30	150	160	20 – 25
Nut cake (tin)	150 – 170	60 – 70	150	160	40 – 46
Fresh fruit cake with topping (glass tray)	150 – 170	45 – 50	150	160	30 – 35
Fresh fruit cake (glass tray)	150 – 170	35 – 45	150	160	25 – 30
Fresh fruit cake (tin)	150 – 170	50 – 60	150	160	40 – 44
Flan base	150 – 170	25 – 30	150	160	15 – 20
<b>Whisked mixture</b>					
Tart	160 – 180	30 – 35	–	–	–
Flan base	160 – 180	20 – 25	–	–	–
Swiss roll	160 – 180	15 – 20	–	–	–
<b>Rubbed-in mixture</b>					
Tart / flan base	150 – 170	20 – 25	150	160	15 – 20
Crumble cake	150 – 170	40 – 50	150	160	30 – 36
Small cakes <sup>1)</sup>	150 – 170	15 – 25	–	–	–
Cheesecake	150 – 170	75 – 85	150	160	64 – 70
Apple pie	150 – 170	45 – 55	150	160	38 – 48
Apricot tart with topping	150 – 170	60 – 70	150	160	50 – 60
Savoury pastry <sup>2)</sup>	190 – 200	25 – 35	–	–	–
<b>Yeast mixtures</b>					
Hot cross buns	160 – 170	20 – 25	150	–	–
Granary loaf	–	–	300	200	30 – 35
Stollen	150 – 170	50 – 60	150	160	30 – 34
White loaf	160 – 180	40 – 50	–	–	–
Wholemeal loaf	170 – 190	50 – 55	–	–	–
Pizza (glass tray)	170 – 190	40 – 50	150	180	36 – 40
<b>Choux pastry</b>					
Eclairs <sup>1)</sup>	160 – 180	25 – 30	–	–	–
<b>Flaky pastry<sup>1)</sup></b>					
	170 – 190	20 – 25	–	–	–
<b>Meringues</b>					
	70	180 – 240	–	–	–
<b>Macaroons<sup>1)</sup></b>					
	120 – 140	35 – 45	–	–	–

The times given are calculated on the basis of an oven which has not been pre-heated.

With a pre-heated oven shorten times by up to 10 minutes.

1) First and second shelf support levels.

2) Pre-heat the oven.

**Consult the cookbook supplied with your oven and/or a good microwave / microwave combi-oven cookbook for further details on these and other foods.**

**The information given in this chart is intended only as a guide.**

# Cleaning and care

---

## Appliance front and control panel

- All external surfaces and controls can be cleaned using warm water with a little washing up liquid applied with a soft sponge.
- Wipe the surfaces dry using a soft cloth.

## E-Cloth

A microfibre "E-Cloth" is available from the Miele UK Spare Parts Department, Part number 98013530, which is suitable for cleaning surfaces such as stainless steel, glass, plastic and chrome without the use of chemicals.

To prevent the risk of scratches and damage to the surface structure of glass, stainless steel and aluminium fronted appliances pay particular attention to the following cleaning instructions.

## Glass fronted appliances

The appliance front and controls are susceptible to scratches and abrasion.

Avoid:

- abrasive cleaning agents, e.g. powder cleaners and cream cleaners.
- abrasive sponges, e.g. pot scourers or sponges which have been previously used with abrasive cleaning agents,
- oven sprays.

Clean the door handle and the control elements regularly, preferably after each use. This will help prevent grease or other deposits adhering to surfaces and becoming impossible to remove.

## Aluminium fronted appliances

Aluminium is affected by the way that light falls it, by the surrounding environment and by the angle you observe it from.

Aluminium surfaces and controls may suffer discolouration or damage if soiling is left on them for too long. Remove any soiling straight away.

The appliance front and controls are susceptible to scratches and abrasion.

Avoid:

- cleaning agents containing soda, acids or chlorides,
- abrasive cleaning agents, e.g. powder cleaners and cream cleaners.
- abrasive sponges, e.g. pot scourers or sponges which have been previously used with abrasive cleaning agents,
- stainless steel cleaners,
- cleaning agents containing descaling agents,
- dishwasher detergent,
- oven sprays.

## Stainless steel fronted appliances

The appliance front and controls are susceptible to scratches and abrasion.

Please observe the cleaning instructions for

- stainless steel surfaces,
- stainless steel coloured controls

## Stainless steel surfaces

Stainless steel surfaces can be cleaned using a proprietary non-abrasive cleaning agent designed specifically for use on stainless steel.

Avoid:

- cleaning agents containing soda, acids or chlorides,
- abrasive cleaning agents, e.g. powder cleaners and cream cleaners.
- abrasive sponges, e.g. pot scourers or sponges which have been previously used with abrasive cleaning agents.

To help prevent re-soiling, proprietary conditioning agent for stainless steel can also be used.

Apply sparingly with even pressure using a soft cloth.

## Stainless steel coloured controls

The controls may suffer discolouration or damage if soiling is left on them for too long.

Remove any soiling straight away.

Avoid:

- cleaning agents containing soda, acids or chlorides,
- abrasive cleaning agents, e.g. powder cleaners and cream cleaners.
- abrasive sponges, e.g. pot scourers or sponges which have been previously used with abrasive cleaning agents,
- stainless steel cleaners,
- oven sprays.

## Oven interior

The oven interior is stainless steel. The high temperatures possible when operating in a traditional oven mode can cause the steel to darken slightly.

The oven interior is hot after use.

Take care not to burn yourself. Clean the oven interior regularly, preferably after each use. If left too long cleaning becomes unnecessarily difficult, and in extreme cases impossible.

Turn the function selector to the Light setting and clean using a solution of hot water and washing up liquid or mild detergent applied with a sponge, soft brush or damp cloth. Wipe dry with a soft cloth.

## Cleaning and care

If anything has become burnt on, use a non-abrasive mild cream cleaner or a proprietary cleaner for stainless steel, applied with a non-scouring kitchen sponge.

Do not use too much water on the cloth or sponge and do not let water or any other substance find its way into any openings.

Residues of fruit juices as well as cake mixtures are best removed while the oven is warm. Spillages of fruit juices can cause lasting discoloration.

If using an oven spray, the manufacturer's instructions must be followed. Do not spray into any of the openings.

### Glass floor pane

The glass floor pane can be removed for cleaning.

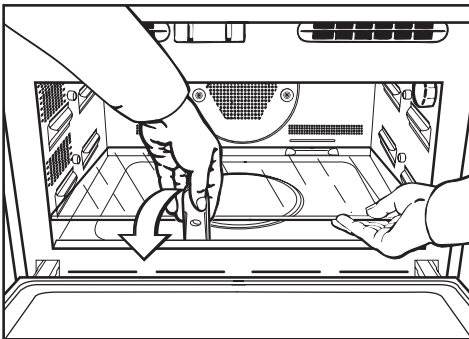

- Insert the spatula provided between the glass floor pane and the front edge of the appliance.
- Carefully lever the pane upwards and support it with the other hand.

- Gently lift the glass pane and take it out carefully.
- Clean in the dishwasher or wash by hand.

When washing the glass pane by hand lay it on a smooth surface, to avoid any damage.

Do not use any scouring agents. These cause scratches.

Carefully refit the glass pane as follows:

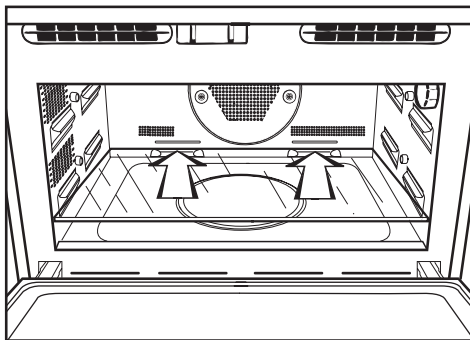

- Holding the pane with both hands position it over the supports on the interior back wall, and lower gently at the front. Make sure the glass pane lies straight in the oven.

## Oven interior roof

If the oven interior roof is particularly soiled, the grill element can be lowered to make cleaning easier.

Wait until the grill element has cooled down before lowering it to avoid the danger of being burnt.

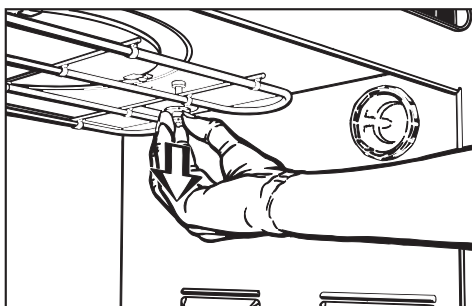

- Pull the fixing knob downwards to lower the grill element.

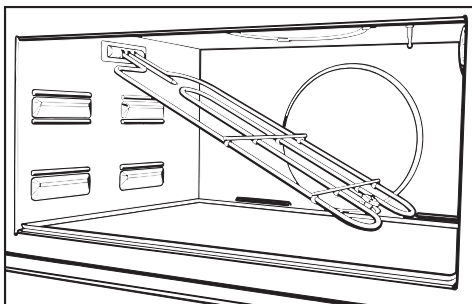

- Lower the grill element gently.

Do not use force to lower it as this could cause damage.

- After cleaning the grill element, raise it gently back up again and secure. The fixing knob must engage.

## Door interior

Always keep the door interior clean. Do not use any scouring agent. Check the door and door seal at regular intervals for any sign of damage.

If any damage is noticed, the oven should not be used again in microwave mode until the fault has been rectified by a service technician.

## Accessories

### Rack

Wash and dry the rack after each use. Remove stubborn soils with a stainless steel cleaner.

### Glass tray

The glass tray can be washed in hot water and washing up liquid, or in the dishwasher.

Do not use scouring agents. These would scratch.

### Boiling rod

The boiling rod can be washed in a dishwasher.

## Special accessories

### Glass back panel with grease filter

The removable grease filter can be washed in hot water and washing up liquid, or in the dishwasher.

## Problem solving guide

Repairs to this appliance should only be carried out by a suitably qualified and competent service technician approved by Miele. Unauthorised repairs could be dangerous.

The following can be corrected without calling the Miele Service Department:

### What to do if . . . .

#### . . . the display area is dark

- Check whether:
  - the appliance is correctly plugged in,
  - the mains fuse has blown (call the Service Department),

#### . . . a process will not start.

- Check whether:
  - if operating in microwave mode the appliance door is properly shut,
  - if operating in microwave mode a power setting and time have been entered.

#### . . . the microwave / heating functions but not the interior lighting.

The halogen bulb needs replacing. Replace it with a new one as follows:

Disconnect the appliance from the electricity supply, (switch off and unplug at the socket, or remove the fuse, or switch off at the isolator as appropriate).

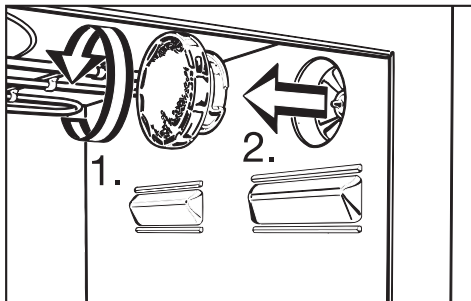

- Loosen and remove the lamp cover (1.). This may be easier using a rubber glove.
- Take out the halogen lamp (2). Exercise caution when changing a light bulb. Halogen lights get very hot during use and will remain hot for some time after being switched off.
- Do not touch the surface directly when changing the bulb as grease particles from your fingers will adhere to the surface and damage it. Please follow manufacturer's instructions.
- Fit a new halogen lamp.

Connection data for halogen lamp:  
12 V, 10 W  
Temperature resistant to 300 °C,  
W271 socket, Osram, Type 64418

The pins must lie horizontally to the appliance. Push the lamp in until it engages.

- Screw the lamp cover back on.
- Reconnect the appliance to the mains supply.

### **... the food is not sufficiently heated or is not cooked at the end of a set time**

#### ■ Check whether:

- the cooking process has been interrupted and was not re-started,
- if cooking / reheating in microwave mode the correct time was selected for the setting chosen.  
A lower power setting normally requires a longer time.

### **... cakes or biscuits are not cooked after a recommended time**

#### ■ Check whether:

- the correct temperature was set.
- there has been a change to the recipe. The addition of more liquid or more eggs makes a moister mix which would take longer to cook.
- whether the grease filter had been left in place. A longer time would be needed if this were the case.

### **... cakes or biscuits are unevenly browned**

There will always be a degree of difference in browning.

#### ■ If browning is very uneven, check:

- whether the temperature was set too high,
- whether the glass tray had been pushed so far in that it touched the back wall,
- whether the grease filter had been left in place on the back wall,

- the colour and composition of the baking tins being used. Try using a different tin next time.

### **... food cools down too quickly after being reheated or cooked in microwave mode.**

When cooked by microwaves, food begins to cook from the outside first, the inside of the food relying on the slower conduction of heat. If food is cooked at a high power level it is possible that the heat may not have reached the centre of the food. During standing time heat is transferred to the centre of the food. Food may be warm in the middle but cool on the edge.

When reheating food with different densities, such as plated meals, it is sensible to start with a low power level and lengthen the time required.

### **... strange noises are heard when the microwave or microwave / combination mode is being used.**

#### ■ Check whether

- sparks are being created by the use of metallic crockery, (see "suitable crockery").
- the food is covered with aluminium foil. If so, remove it.

## After sales service

---

### Customer contact

In the events of any faults which you cannot easily remedy, please contact

– your Miele dealer

or

– the Miele Service Department.  
See address on the back page.

– When contacting the Service department please quote the model and serial number of your appliance, given on the data plate which is located on the front of the oven interior, visible when the door is opened.

Please note that telephone calls may be monitored and recorded to improve our service.



All electrical work should be carried out by a suitably qualified and competent service technician approved by Miele in strict accordance with national and local safety regulations.

Depending on the version, the appliance is supplied with a mains cable, or a mains cable and plug for connection to a.c. 50 Hz, 230 - 240 V single phase supply.

The voltage, rated load and fuse rating are given on the data plate situated at the front of the oven interior. Please ensure that these match the household mains supply.

Connection should be made via a fused connection unit or a fused plug and a suitable switched socket, (rated load under 3000 W), or via a suitable isolator (rated load over 3000 W), which complies with national and local safety regulations, and the on/off switch should be easily accessible after the appliance has been installed.

If the socket is not accessible after installation (depending on country) an additional means of disconnection must be provided for all poles.

When switched off there must be an all-pole gap of 3 mm in the isolator switch (including switch, fuses and relays acc. to EN 60335).

For extra safety it is advisable to install a residual current device with a trip current of 30 mA (in accordance with DIN VDE 0664, VDE 0100 Section 739).

If the cable is damaged a new cable must be fitted by a Miele approved service engineer.

In certain unfavourable circumstances microwave appliances can be a source of interference. In this event please contact your dealer or the Miele Service Dept.

If the appliance is connected via an isolator switch the plug must be cut off and rendered useless.

## Important U.K.

The wires in the mains lead of this appliance are coloured in accordance with the following code:

**Green/yellow = Earth**

**Blue = Neutral**

**Brown = Live**

As the colours of the wires in the mains lead of this appliance may not correspond with the markings identifying the terminals in your plug, proceed as follows:

The wire coloured green and yellow must be connected to the terminal in the plug which is marked with the letter E or by the earth symbol  $\perp$  or coloured green or green and yellow.

The wire coloured blue must be connected to the terminal marked with the letter "N" or coloured black. The wire coloured brown must be connected to the terminal marked with the letter "L" or coloured red (U.K.).

**WARNING**  
**THIS APPLIANCE MUST BE**  
**EARTHED**

## **Non-rewireable plugs BS 1363**

If this machine or appliance is fitted with a non-rewireable plug, the following information applies: if the socket outlets are not suitable for the plug supplied with this product, it must be cut off and an appropriate plug fitted. The fuse carrier and fuse should be removed from the plug and disposed of. The plug cut from the flexible cord should then be disposed of and on no account be inserted into any socket elsewhere in the house (electric shock hazard).

The fuse cover must be re-fitted when changing the fuse, and if the fuse cover is lost the plug must not be used until a suitable replacement is obtained. The colour of the correct replacement cover is that of the coloured insert in the base of the plug, or the colour that is embossed in words on the base of the plug, (as applicable to the design of plug fitted).

The correct rating of the replacement fuses that are ASTA approved to BS 1362 should be fitted. Replacement covers may be purchased from your local electrical supplier, electricity showroom or Miele service agent.

All electrical work should be carried out by a competent person, in accordance with national and local safety regulations.

Depending on the version, the appliance is supplied with a mains cable, or a mains cable and plug for connection to a.c. 50 Hz, 230 - 240 V.

The voltage, rated load and fuse rating are given on the **data plate** situated at the front of the oven interior. Please ensure that these match the household mains supply.

For extra safety it is advisable to install a residual current device (RCD) with a trip current of 30 mA.

Connection for the appliance should be made via a suitable isolator which complies with national and local regulations, and which is accessible after the appliance has been built in.

## Test marks

Electrical safety, C-Tick Mark

Electrically suppressed according to AS/NZS 1044

## Important

The wires in the mains lead are coloured in accordance with the following code:

Green / yellow = earth

Blue = neutral

Brown = live

As the colours of the wires in the mains lead of this appliance may not correspond with the coloured markings identifying the terminals in your plug, proceed as follows:

The wire which is coloured green and yellow must be connected to the terminal in the plug which is marked with the letter E or by the earth symbol  $\perp$  or coloured green or green and yellow.

The wire which is coloured blue must be connected to the terminal which is marked with the letter N or coloured black.

The wire which is coloured brown must be connected to the terminal which is marked with the letter A or coloured red.

**WARNING**  
**THIS APPLIANCE MUST BE**  
**EARTHED**

# Installation

## Possibilities for installation and combination

The appliance is suitable for installation:

- in a tall unit in combination with an oven,
- in a tall unit,
- in a base unit.

## Installation measurements

### Installation in a tall unit in combination with an oven

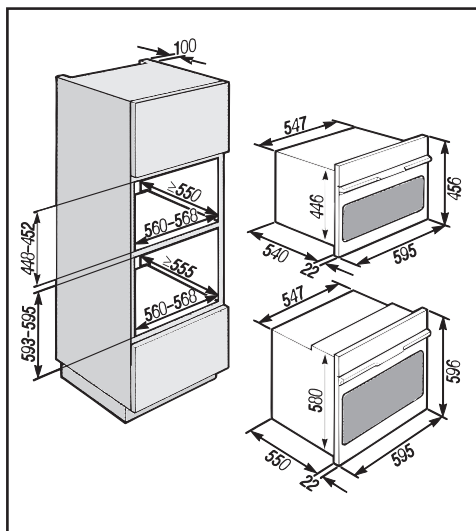

### Installation in a tall unit

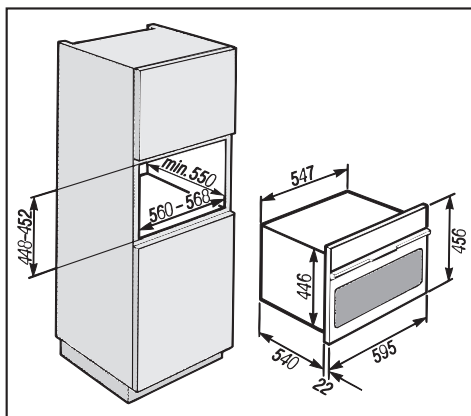

### Installation in a base unit

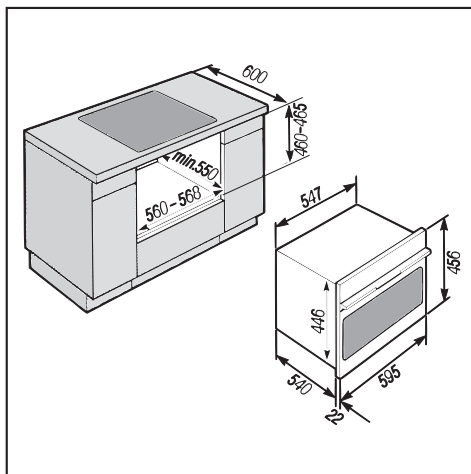

If fitted in combination with a hob, the installation instructions for the hob must also be taken into account.

## Installation instructions

- Turn off the mains electricity supply for connecting to an isolator.

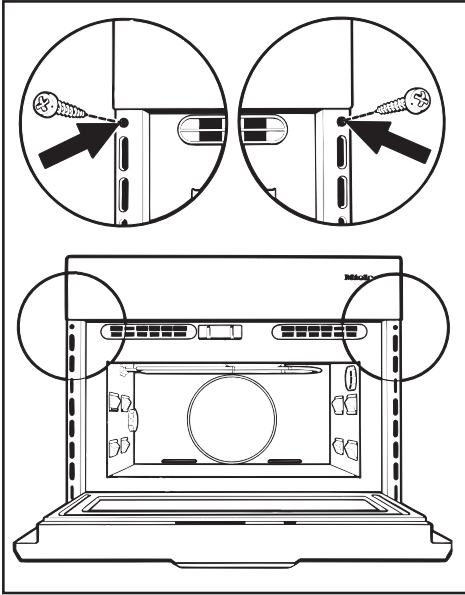

- Connect the oven to the electricity supply.
- Push the oven into the furniture unit as far as the oven trim and align.
- Open the oven door, and with two screws secure the oven to the side walls of the furniture unit through the holes in the oven trim.

The appliance must only be operated when it has been built in.





**United Kingdom:**

Miele Co. Ltd.

Fairacres, Marcham Road, Abingdon, Oxon, OX14 1TW

tel. Abingdon (01235) 554455 - fax (01235) 554477

Service Office, tel. Abingdon (01235) 554466

Internet: [www.miele.co.uk](http://www.miele.co.uk)

**Ireland:**

Miele Ireland Ltd.

Broomhill Road, Tallaght, Dublin 24

Tel: (01) 46 10 710, Fax: (01) 46 10 797

Email: [info@miele.ie](mailto:info@miele.ie)

Internet: <http://www.miele.ie>

**Australia:****Miele Australia Pty. Ltd.**

A.C.N. 005635398

- 1 Gilbert Park Drive

Knoxfield, VIC 3180

Telephone: (03) 9764 7100

Fax: (03) 9764 7129

- 3 Skyline Place

Frenchs Forest, NSW 2086

Telephone: (02) 8977 4200

Fax: (02) 8977 4219

- 25 Lavarack Avenue

Eagle Farm, QLD 4009

Telephone: (07) 3632 2400

Fax: (07) 3632 2449

- 209 Richmond Road

Richmond, SA 5033

Telephone: (08) 8351 8500

Fax: (08) 8354 1717

**Distributor Western Australia:**

G.B.I. Sales Pty. Ltd.

27-33 Cleaver Terrace

Belmont, WA 6104

Telephone: (08) 9478 0466

Fax: (08) 9478 0470

**Miele Southeast Asia**

Miele Pte. Ltd.

163 Penang Road

# 04 - 02/03 Winsland House II

Singapore 238463

Tel : +65-67351161

Fax: +65-67351191

Email: [mielesea@miele.com.sg](mailto:mielesea@miele.com.sg)

**South Africa:**

Miele (Pty.) Ltd.

304 Tungsten Road

Strydom Park 2194

P.O.Box 1654, Randburg 2125

Tel. (011) 793-7452

Telefax (011) 793-7447

E-mail: [mieleza@iafrica.com](mailto:mieleza@iafrica.com)

Internet: [www.miele.co.za](http://www.miele.co.za)

**Distributor New Zealand:**

Steelfort Engineering Company, Ltd.

- 500 Rangitikei Street

Palmerston North, Priv. Bag 11045, NZ

Telephone: (06) 350 1350

Fax: (06) 356 1507

- Unit L, 10-20 Sylvia Park Road,

Mt. Wellington, Auckland, NZ

Telephone: (09) 573 1269

Fax: (09) 573 1268