

VentA Hood® RETRO STYLE UNDER CABINET RANGEHOOD SPECIFICATIONS

CLH9 Halogen lights only.

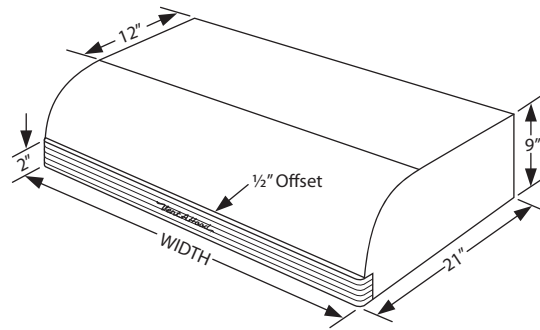

CLH9

Connection Diagram (30" - 48" Widths)

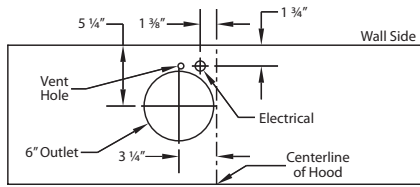

300 CFM B100 Single Blower (Top View)

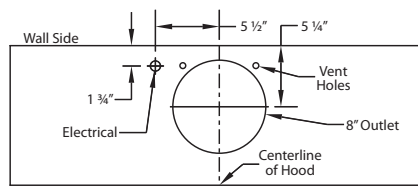

600 CFM B200 Dual Blower (Top View)

Connection Diagram (42" - 48")

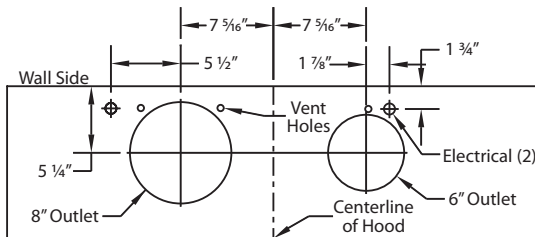

900 CFM B200 Dual & B100 Single Blower (Top View)

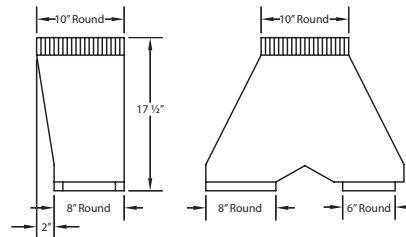

VP562 Transition (Optional) For B300 (B200 Dual Blower & B100 Single Blower)

Connection Diagram (48")

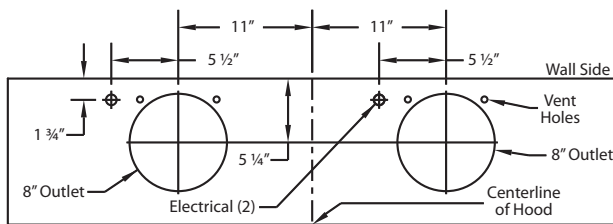

1200 CFM Double B200 Dual Blowers (Top View)

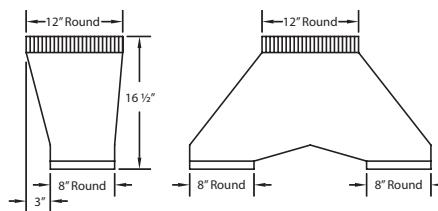

VP563 Transition (Optional) For B400 (Double B200 Dual Blowers)

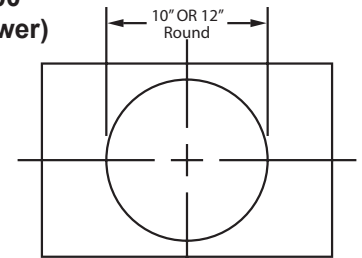

VP562/VP563 transition centers outlet over top of hood

Recommended Mounting Height*

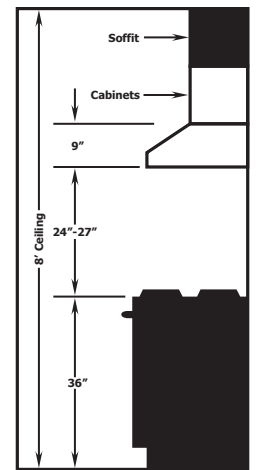

*Exceeding recommended mounting height may compromise performance.

Electrical/Mechanical Specifications For Blower Units

Model	Volts	Amps*	RPM	CFM SP@0.0"	Equivalent CFM#	CFM SP@0.1"	CFM SP@0.2"	CFM SP@0.3"	Minimum Round Duct Size	Square Inches
B100 Single	115	1.7	1550	300	450	286	270	240	6" (or equivalent)	28
B200 Dual	115	3.4	1550	600	900	572	540	480	8" (or equivalent)	50

* Note: Add 0.5 amp for each halogen light. Hood is available halogen lights (2 lights: 30" - 41", 3 lights: 42" - 48").

Because the Magic Lung® uses centrifugal filtration rather than conventional baffle or mesh filters, the Magic Lung® blower can handle cooking equipment with higher cubic feet per minute (CFM) requirements and can deliver equivalent CFM much more efficiently than other filtration systems. When comparing the Magic Lung® with other blower units made by other manufacturers, use the "Equivalent CFM".

