



Trimmer Attachment

Operator's Manual

MODEL 99944200545

FOR MODELS:

- SRM-2400SB**
- SRM-260SB/261SB**
- PAS-230/231**
- PAS-260/261**
- PAS-2601**
- PAS-265**



WARNING

Read rules for safe operation and instructions carefully. ECHO provides an Operator's Manual and a Safety Manual for Pro Attachment Series power source or Split Boom Trimmer. Those manuals and this manual must be read and understood for proper and safe operation, otherwise serious personal injury may result.

INTRODUCTION

Welcome to the ECHO family. This ECHO product was designed and manufactured to provide long life and on-the-job-dependability. Read and understand this manual and the SAFETY MANUAL you found in the same package. You will find both easy to use and full of helpful operating tips and SAFETY messages.

THE OPERATOR'S MANUAL

Read and understand this manual before operation. Keep it in a safe place for future reference. It contains specifications and information for operation and maintenance specific to the attachment.

THE SAFETY MANUAL

Explains possible hazards and what measures you should take to insure safe operation.

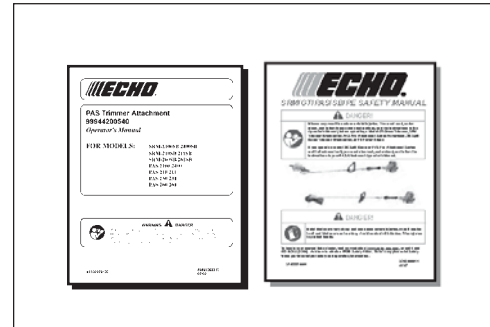

TABLE OF CONTENTS

Introduction	2	Maintenance	11
- The Operator's Manual	2	- Skill Levels	11
- The Safety manual	2	- Maintenance Intervals	11
Safety	3	- Lubrication	11
- Manual Safety Symbols & Important Information	3	- Nylon Line Replacement	12
- International Symbols	3	Storage	14
- Personal Condition and Safety Equipment	4	Specifications	14
- Equipment	6	Servicing Information	16
Description	7	- Parts/Serial Number	16
Contents	8	- Service	16
Assembly	8	- ECHO Consumer Product Support	16
- Power Head Shaft / Lower Shaft Assembly	8	- Warranty Card	16
- Plastic Shield Installation	8	- Additional or Replacement Manuals	16
- Nylon Head Installation	9		
- Remove Nylon Line Head	10		
Operation	10		
- To Advance Trimmer Line	10		

Specifications, descriptions and illustrative material in this literature are as accurate as known at the time of publication, but are subject to change without notice. Illustrations may include optional equipment and accessories, and may not include all standard equipment.

SAFETY

MANUAL SAFETY SYMBOLS AND IMPORTANT INFORMATION

Throughout this manual and on the product itself, you will find safety alerts and helpful, informational messages preceded by symbols or key words. The following is an explanation of those symbols and key words and what they mean to you.

DANGER

The safety alert symbol accompanied by the word “DANGER” calls attention to an act or condition which **WILL** lead to serious personal injury or death if not avoided.

WARNING

The safety alert symbol accompanied by the word “WARNING” calls attention to an act or condition which **CAN** lead to serious personal injury or death if not avoided.

CAUTION

The safety alert symbol accompanied by the word “CAUTION” calls attention to an act or condition which may lead to minor or moderate personal injury if not avoided.



CIRCLE AND SLASH SYMBOL

This symbol means the specific action shown is prohibited. Ignoring these prohibitions can result in serious or fatal injury.

NOTE











This enclosed message provides tips for use, care and maintenance of the unit.

IMPORTANT

The enclosed message provides information necessary for the protection of the unit.

INTERNATIONAL SYMBOLS

Symbol form/shape	Symbol description/application	Symbol form/shape	Symbol description/application
	"WARNING, SEE OPERATOR'S MANUAL"		Hot Surface
	Wear eyes, ears and head protection		Fuel and oil mixture
	Finger Severing		Emergency stop
	Wear hand and foot protection		WARNING
			Keep bystanders and helpers away 15 m (50 ft).

Symbol form/shape	Symbol description/application	Symbol form/shape	Symbol description/application
	Carburetor adjustment - High speed mixture		Primer Bulb
	Carburetor adjustment - Idle speed		Ignition ON/OFF
	Carburetor adjustment - Low speed mixture		Engine choke control.
	DO NOT USE BLADES - Line Head Only		Do not operate without guards and shields in place.
	Do not exceed 10,000 RPM.		BEWARE - Thrown, Ricochet objects

PERSONAL CONDITION AND SAFETY EQUIPMENT



WARNING

Users of this product risk injury to themselves and others if the unit is used improperly and/or safety precautions are not followed. Proper clothing and safety gear must be worn when operating unit.

Physical Condition

Your judgment and physical dexterity may not be good:

- if you are tired or sick,
- if you are taking medication,
- if you have taken alcohol or drugs.

Operate unit only if you are physically and mentally well.

Eye Protection

Wear eye protection that meets ANSI Z87.1 or CE requirements whenever you operate the unit.

Hand Protection

Wear no-slip, heavy-duty work gloves to improve your grip on the handle. Gloves also reduce the transmission of machine vibration to your hands.

Hearing Protection

ECHO recommends wearing hearing protection whenever unit is used.

Proper Clothing

Wear snug fitting, durable clothing;

- Pants should have long legs, shirts with long sleeves.
- DO NOT WEAR SHORTS,
- DO NOT WEAR TIES, SCARFS, JEWELRY.

Wear protective hair covering to contain long hair.

Wear sturdy work shoes with nonskid soles;

- DO NOT WEAR OPEN TOED SHOES,
- DO NOT OPERATE UNIT BAREFOOTED.

Keep long hair away from engine and air intake. Retain hair with cap or net.

Hot Humid Weather

Heavy protective clothing can increase operator fatigue which may lead to heat stroke. Schedule heavy work for early morning or late afternoon hours when temperatures are cooler.

Extended Operation/Extreme Conditions

It is believed that a condition called Raynaud's Phenomenon, which affects the fingers of certain individuals, may be brought about by exposure to vibration and cold. Exposure to vibration and cold may cause tingling and burning sensations, followed by loss of color and numbness in the fingers. The following precautions are strongly recommended, because the minimum exposure, which might trigger the ailment, is unknown.

- Keep your body warm, especially the head, neck, feet, ankles, hands, and wrists.
- Maintain good blood circulation by performing vigorous arm exercises during frequent work breaks, and also by not smoking.
- Limit the hours of operation. Try to fill each day with jobs where operating the unit or other hand-held power equipment is not required.
- If you experience discomfort, redness, and swelling of the fingers followed by whitening and loss of feeling, consult your physician before further exposing yourself to cold and vibration.



Repetitive Stress Injuries

It is believed that overusing the muscles and tendons of the fingers, hands, arms, and shoulders may cause soreness, swelling, numbness, weakness, and extreme pain in those areas. Certain repetitive hand activities may put you at a high risk for developing a Repetitive Stress Injury (RSI). An extreme RSI condition is Carpal Tunnel Syndrome (CTS), which could occur when your wrist swells and squeezes a vital nerve that runs through the area. Some believe that prolonged exposure to vibration may contribute to CTS. CTS can cause severe pain for months or even years.

To reduce the risk of RSI/CTS, do the following:

- Avoid using your wrist in a bent, extended, or twisted position. Instead try to maintain a straight wrist position. Also, when grasping, use your whole hand, not just the thumb and index finger.
- Take periodic breaks to minimize repetition and rest your hands.
- Reduce the speed and force with which you do the repetitive movement.
- Do exercise to strengthen the hand and arm muscles.
- Immediately stop using all power equipment and consult a doctor if you feel tingling, numbness, or pain in the fingers, hands, wrists, or arms. The sooner RSI/CTS is diagnosed, the more likely permanent nerve and muscle damage can be prevented.

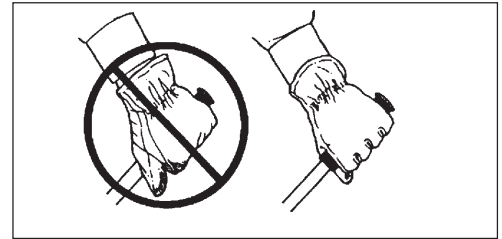

DANGER

Do not operate this product indoors or in inadequately ventilated areas. Engine exhaust contains poisonous emissions and can cause serious injury or death.

Read the Manuals

- Provide all users of this equipment with the Operator's Manual and Safety Manual for instructions on Safe Operation.

Clear the Work Area

- Spectators and fellow workers must be warned, and children and animals prevented from coming nearer than 15 m (50 ft.) while the unit is in use.

Keep a Firm Grip

- Hold the front and rear handles with both hands, with thumbs and fingers encircling the handles.

Keep a Solid Stance

- Maintain footing and balance at all times. Do not stand on slippery, uneven or unstable surfaces. Do not work in odd positions or on ladders. Do not over reach.

Avoid Hot Surfaces

- Keep exhaust area clear of flammable debris. Avoid contact during and immediately after operation.



EQUIPMENT



WARNING

Use this attachment with ECHO approved models only. Serious injury may result from the use of this attachment combined with a non approved ECHO product.

- Check unit for loose/missing nuts, bolts, and screws. Tighten and/or replace as needed.
- Inspect shield for damage and ensure that the cut-off knife is securely in place. Replace if either is damaged or missing.
- Check that the cutting attachment is firmly attached and in safe operating condition.
- Check that front loop handle and shoulder strap/ or shoulder/waist harness are adjusted for safe, comfortable operation. See Assembly Section for proper adjustment.

NOTE

ECHO, INC. will not be responsible for the failure of cutting devices, attachments or accessories which have not been tested and approved by ECHO.



WARNING

Moving parts can amputate fingers or cause severe injuries. Keep hands, clothing and loose objects away from all openings.

- **ALWAYS** stop engine, disconnect spark plug, and make sure all moving parts have come to a complete stop before removing obstructions, clearing debris, or servicing unit.
- **DO NOT** start or operate unit unless all guards and protective covers are properly assembled to unit.
- **NEVER** reach into any opening while the engine is running. Moving parts may not be visible through openings.

DESCRIPTION

Locate this safety decal on your unit. The complete unit illustration, found in the "DESCRIPTION" section, will help you locate it. Make sure the decal is legible and that you understand and follow the instructions on it. If the decal cannot be read, a new one can be ordered from your ECHO dealer. See PARTS ORDERING instructions for specific information.

Shaft Decal

P/N 89016054130

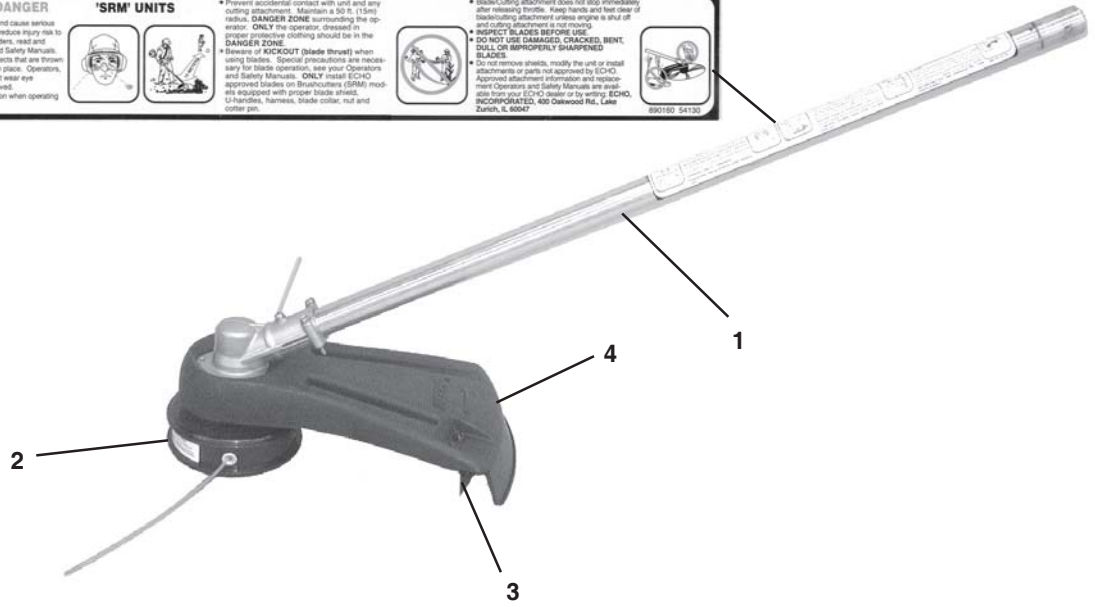

1. **DRIVE SHAFT ASSEMBLY** - Contains a specially designed liner and the flexible drive shaft.
2. **NYLON CUTTING ATTACHMENT** - Contains replaceable nylon trimming line that advances when the trimmer head is tapped against the ground while the head is turning at normal operating speed.
3. **CUT-OFF KNIFE** - Automatically trims line to the correct length: 5 in. after head is tapped on the ground. If trimmer is operated without a cut-off knife the line will become too long, the engine will overheat and engine damage may occur.
4. **PLASTIC DEBRIS SHIELD ASSEMBLY** - Shield assembly includes the Cut-Off Knife and Safety Decal. Helps protect the operator by deflecting debris produced during the trimming operation. This shield must be replaced with the steel shield for blade use.

CONTENTS

The ECHO product you purchased has been factory pre-assembled for your convenience. Due to packaging restrictions, shield installation and other assembly may be necessary.

After opening the carton, check for damage. Immediately notify your retailer or ECHO Dealer of damaged or missing parts. Use the contents list to check for missing parts.

- ___ 1 - PAS Hi Torque Trimmer Attachment
- ___ 1 - Operator's Manual
- ___ 1 - Safety Manual
- ___ 1 - Warranty Registration Card
- ___ 1 - Locking Tool
- ___ 1 - T-Wrench
- ___ 1 - Plastic Debris Shield
- ___ 1 - Nylon Trimmer Head
- ___ 1 - Safety Goggle
- ___ 1 - Shield Plate
- ___ 3 - 5mm x 16mm Screws (shield mounting)
- ___ 1 - Storage Hook Assembly

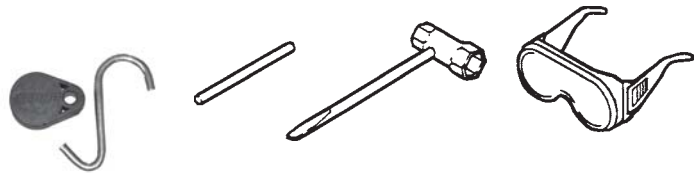
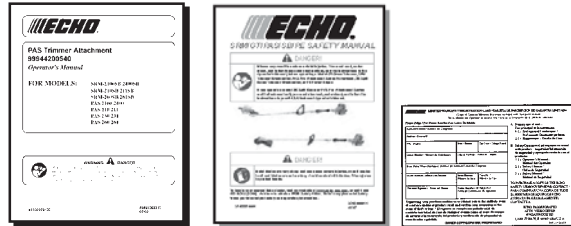

ASSEMBLY

POWER HEAD SHAFT/LOWER SHAFT ASSEMBLY

Tools Required: None

Parts Required: PAS or SRM-SB Power Head w/Shaft & Coupling.

1. Set Power Head/Shaft Assembly on a level surface.
2. Pull locator pin (A) out, and turn counter-clockwise 1/4 turn to lock-out position.
3. Remove vinyl cap from attachment drive shaft.
4. Carefully fit attachment drive shaft assembly into coupler (B) to decal assembly line (C), making sure that the inner lower drive shaft engages into the square upper drive shaft socket.

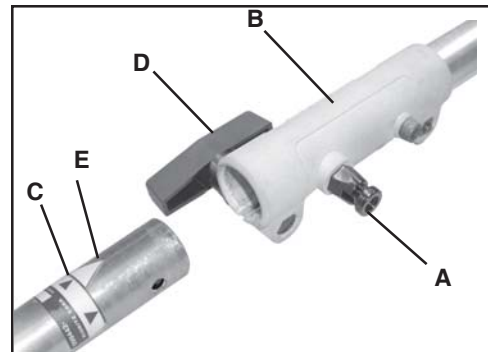

NOTE

Earlier model Power Heads may have shorter couplings. Short couplings fit flush to decal point (E). New couplings are 4-3/4 in. long, and fit flush to line (C).

NOTE

Lower bearing housing and head assembly must be in line with the engine.

5. Rotate locator pin (A) 1/4 turn clockwise to engage lower shaft hole. Insure locator pin is fully engaged by twisting lower drive shaft. Locator pin should snap flush in coupler. Full engagement will prevent further shaft rotation.
6. Secure lower shaft assembly to coupler by tightening clamping knob (D).

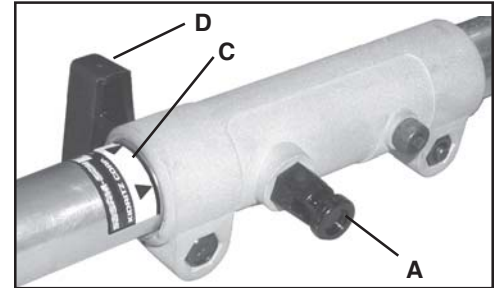

PLASTIC SHIELD INSTALLATION

(For Nylon Line Operation)

Tools Required: Screwdriver.

Parts Required: Plastic Shield, Shield Plate, three (3) 5mm x 16mm screws.

NOTE

The plastic shield is for use with the Nylon Line Head only. Install Metal Shield when using plastic or metal blades.

1. Place plastic shield on bottom of bearing housing flange.
2. Place shield plate on plastic shield, align holes. Install three (3) screws from bottom through plate and shield into gear case.



NYLON LINE HEAD INSTALLATION

(Use with Plastic Shield)

Tools Required: Head Locking Tool

Parts Required: Nylon Line Head.

1. Align locking hole in upper plate with notch in edge of gear housing and insert head locking tool (C).
2. Remove vinyl protector from PTO shaft.
3. Be sure upper adaptor plate remains on PTO shaft (B).
4. Thread line head onto shaft by turning it counter clockwise until head is tight against upper plate (D).
5. Remove head locking tool.

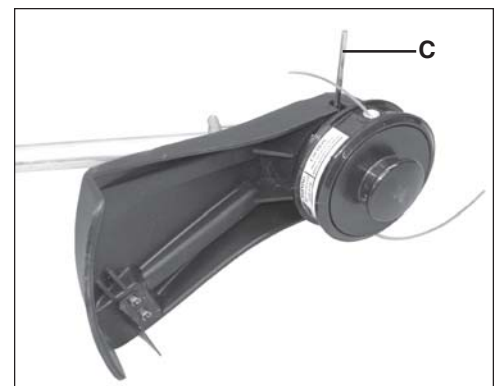
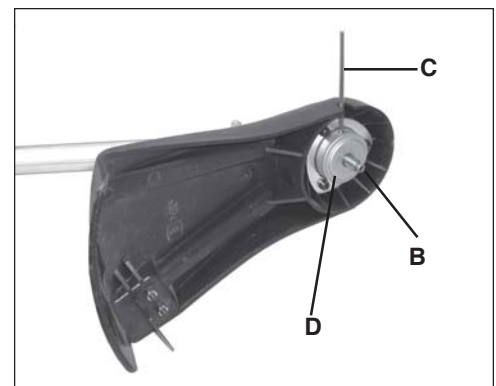

REMOVE NYLON LINE HEAD

1. Align locking hole in upper plate with notch in edge of gear housing and insert head locking tool (C).
2. Remove line head by turning it clockwise until head is completely off of shaft.
3. Remove locking tool.



OPERATION



WARNING

Moving parts can amputate fingers or cause severe injuries. Keep hands, clothing and loose objects away from all openings. Always stop engine, disconnect spark plug, and make sure all moving parts have come to a complete stop before removing obstructions, clearing debris, or servicing unit.



WARNING

The attachment will operate immediately when the engine starts and could result in loss of control and possible serious injury. Keep movable parts of the attachment off the ground and away from objects that could become entangled or thrown.

NOTE

Refer to your Pro Attachment Series Operator's Manual for correct engine fueling, starting and stopping instructions.

NOTE

Refer to the Grass Trimmer / Brush Cutter Safety Manual for proper and safe trimming techniques.



WARNING

Inspect starting area for hazards such as rocks, glass, debris etc. which could be contacted by the cutting attachment when starting. Keep helpers and bystanders at least 15 m (50 ft.) from starting area, otherwise serious personal injury may result.

TO ADVANCE TRIMMER LINE

TIP:

To advance trimmer line, tap trimmer head against the ground while the head is turning at normal operating speed.

MAINTENANCE



WARNING

Moving parts can amputate fingers or cause severe injuries. Keep hands, clothing and loose objects away from all openings. Always stop engine, disconnect spark plug, and make sure all moving parts have come to a complete stop before removing obstructions, clearing debris, or servicing unit.

Your ECHO attachment is designed to provide many hours of trouble free service. Regular scheduled maintenance will help your attachment achieve that goal. If you are unsure or are not equipped with the necessary tools, you may want to take your unit to an ECHO Service Dealer for maintenance. To help you decide whether you want to DO-IT-YOUR-SELF or have the ECHO Dealer do it, each maintenance task has been graded. If the task is not listed see your ECHO dealer for repairs.

SKILL LEVELS

Level 1 = Easy to do. Most required tools come with unit.

Level 2 = Moderate difficulty. Some specialized tools may be required.

MAINTENANCE INTERVALS

<u>Component/System</u>	<u>Maintenance Procedure</u>	<u>Skill Level</u>	<u>Frequency</u>
Drive Shaft	Grease	1	Every 25 hours of use
Gear Housing	Grease	1	Every 50 hours of use
Screws/Nuts/Bolts	Inspect/Tighten/Replace	1	Before each use

LUBRICATION

Level 1.

Tools Required: 8 & 13 mm Open End Wrench, Screwdriver, Clean Rag

Parts Required: POWER BLENDX™ 8 oz. (P/N 91016) or Lithium Base Grease.

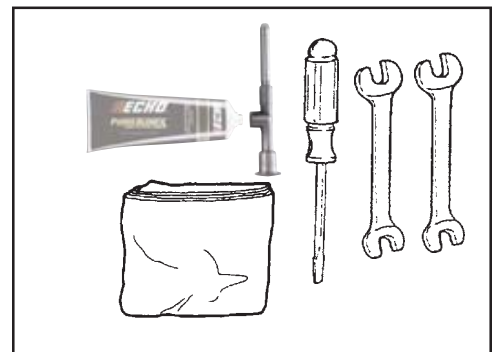

Gear Housing

1. Clean all loose debris from gear box.
2. Remove plug (A) and check level of grease. Grease should fill gear case to bottom of grease plug hole.
3. Add grease if necessary using manual grease gun or squeeze-type tube. Do not use high pressure grease gun. DO NOT over-fill.

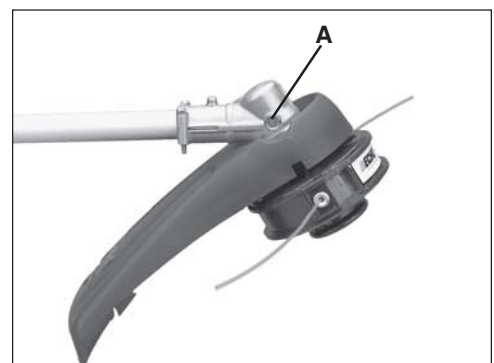

Drive Shaft (Lower)

IMPORTANT

Lower and upper drive shaft must be lubricated with high temperature automotive grease every 25 hours of operation, otherwise drive shaft assembly overheating and failure can result.

1. Loosen two (2) screws (B) and remove center locating screw (C). Pull gear box and shield from drive shaft housing.
2. Pull flexible cable from the drive shaft housing, wipe clean and re-coat with a thin coating [15 ml (1/2 oz.)] of ECHO® LUBE™.
3. Slide the flexible cable back in the drive housing. DO NOT get dirt on the flex cable.
4. Install the gear housing and shield assembly.

IMPORTANT

Flat edge of washers (D) must be against drive shaft.

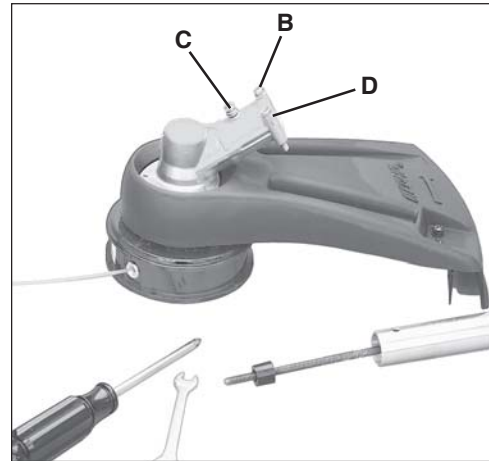

NYLON LINE REPLACEMENT

Level 1.

Parts Required: ECHO 0.095" Nylon Trimmer Line 6 m (20 ft.) long.

1. Shut engine off. Lay unit on the ground with head assembly up.
2. Hold drum (A) and firmly turn spool (B) CW (clockwise) until it disengages from the inner drive. Pull spool from drum. DO NOT push in on spool when turning.

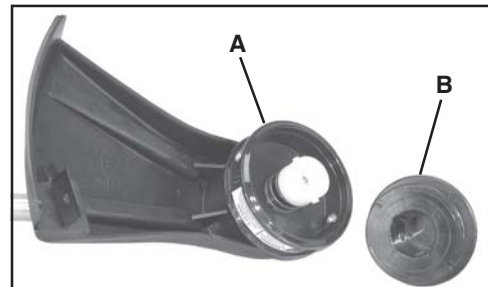
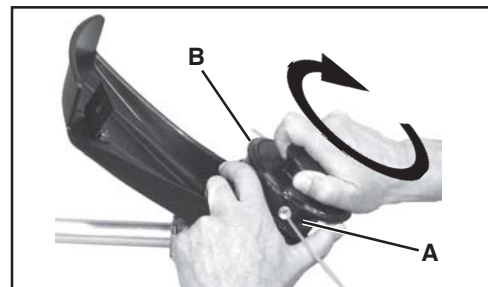

3. Use one piece of new nylon line (C) 6 m (20 ft.) long and thread through the molded loop (D) on the spool. Pull line tight and adjust so one end is 15 cm (6 in.) longer than the other.



4. Hold the spool, opening toward you. Place index finger between the two strands and wind line, tightly and evenly, in direction of arrow (E) marked "CC".

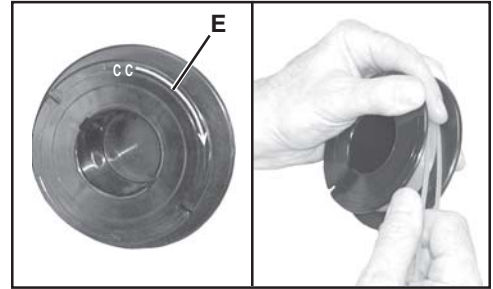

5. Stop when approximately 15-20 cm (6-8 in.) line (C) remains and place ends of line in notches (F) in spool (B).

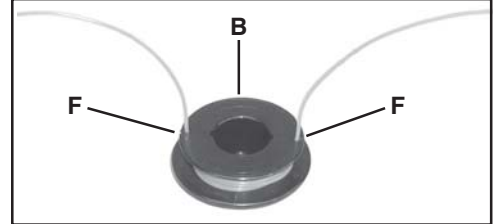

6. Feed ends of line through housing eyelets (G) and place spool (B) over drive (H). Align pegs (I) on drive with notches in spool, and push spool into drum.

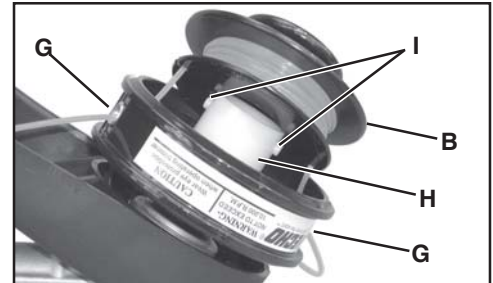

7. Pull on both lines until they come free from notches (F) in spool.

8. Hold drum (A) firmly and turn spool (B) CCW (counterclockwise) until it stops. **DO NOT** push in on spool when turning.

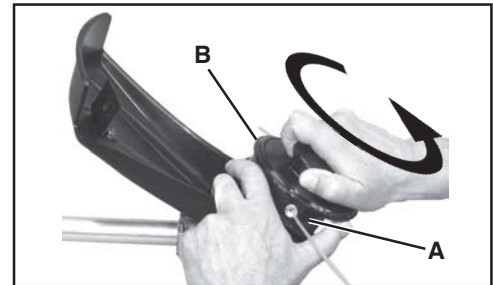

9. Pull both lines out and trim to cut-off knife length.



STORAGE

Storage Hook Installation

1. Insert small end of hook into locating hole on attachment shaft.
2. Slide plastic cap onto end of attachment shaft.

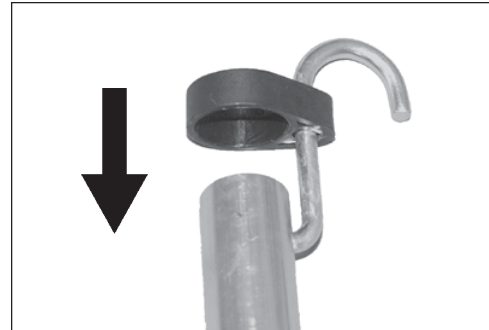

SPECIFICATIONS

MODEL	PAS Hi Torque Trimmer Attachment
Shaft Length	864 mm (34.02 in.)
Attachment Width	176 mm (6.93 in.)
Attachment Height	245 mm (9.65 in.)
Weight (dry) w/line head	1.57 kg (3.43 lb.)
Drive Shaft	6.35 mm (1/4 in.) Flex Shaft
Direction of Rotation	Counter clockwise, viewed from the top
Gear Case Ratio	2.07:1
Cutter Head	Nylon line head with .095 in. Cross Fire™ Line
Line Capacity	6 m (20ft.)

NOTES

SERVICING INFORMATION

PARTS/SERIAL NUMBER

Genuine ECHO Parts and ECHO REPOWER™ Parts and Assemblies for your ECHO products are available only from an Authorized ECHO Dealer. When you do need to buy parts **always** have the Model Number and Serial Number of the attachment with you. You can find these numbers on the driveshaft model/serial number label. For future reference, write them in the space provided below.

Model No. _____ SN. _____

SERVICE

Service of this product during the warranty period must be performed by an Authorized ECHO Service Dealer. For the name and address of the Authorized ECHO Service Dealer nearest you, ask your retailer or call: 1-800-432-ECHO (3246). When presenting your unit for Warranty service/repairs, proof of purchase is required.

ECHO CONSUMER PRODUCT SUPPORT

If you require assistance or have questions concerning the application, operation or maintenance of this product you may call the ECHO Consumer Product Support Department at 1-800-673-1558 from 8:30 am to 4:30 pm (Central Standard Time) Monday through Friday. Before calling, please know the model and serial number of your unit to help your Consumer Product Support Representative.

WARRANTY CARD

This card is our means of registering all original owners of ECHO equipment. The card plus proof of purchase provides you the assurance that authorized warranty work will be done. It also provides a direct link between you and ECHO if we find it necessary to contact you.

ADDITIONAL OR REPLACEMENT MANUALS

Safety Manuals in English/Spanish or English/French are available, free of charge, from your ECHO dealer or at www.echo-usa.com.

Operator's and Parts Manuals are available by:

- Downloading free from www.echo-usa.com
- Purchasing from your Echo Dealer.
- Manuals are available by sending a written request stating the model number and serial number of your Echo unit, part number of the manual, your name and address, and mail to the address below.

Safety Videos are available from your Echo dealer. A \$5.00 shipping charge will be required for each video.



DEALER?

Call
1-800-432-ECHO
or
www.echo-usa.com

CONSUMER PRODUCT SUPPORT

1-800-673-1558
8:30 - 4:30 Mon - Fri C.S.T.



ECHO®

ECHO, INCORPORATED
400 OAKWOOD ROAD
LAKE ZURICH, IL 60047-1564

WWW.ECHO-USA.COM

S08900001001 - S08900004610