

Cat. No. 22-1692  
**OWNER'S MANUAL**

Please read before using this equipment.

# Talking 360° Laser/Radar Detector

with VG-2 Guard

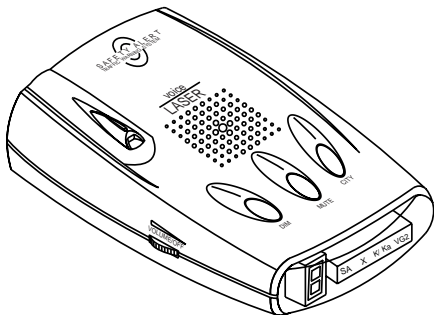

**RadioShack®**

# FEATURES

---

---

Your RadioShack Talking 360° Laser/Radar Detector can alert you to all known police traffic radar and laser systems with its distinct visual and audio alerts, including a real voice alert. It receives X-, K-, and Ka-band radar signals, and detects both the instant-on and laser systems many police departments use to measure vehicle speed. Plus, your detector can give you advance warning of potential road hazards by detecting signals from transmitters that broadcast Safety Alert System™ alerts.

**Note:** Before reading this Owner's Manual, read the supplied booklet *Questions and Answers About Vehicle Speed Detection* to familiarize yourself with the terms and uses associated with your detector.

Your detector's features include:

**Real Voice Alert** — greets you as you turn on the detector and alerts you with 18 different vocal indicators including radar and laser detection.

**360° Detection** — detects laser and radar signals from all around your vehicle.

© 2002 RadioShack Corporation. All Rights Reserved.

RadioShack is a registered trademark used by RadioShack Corporation.

Safety Alert is a trademark of Cobra Electronics.

FAST is a registered trademark used by RadioShack Corporation.

Instaclear is a registered trademark used by Ford Motor Company.

ElectriClear is a registered trademark used by Libbey, Owens, Ford and Delco-Remy.

---

---

**VG-2 Protection** — makes your detector invisible to the VG-2 radar-detector detector when it senses VG-2 operation.

**X-, K-, Ka-Band, and Laser Signal Detection** — warns you when it detects signals from traffic radar or laser devices. Different tones and display indicators let you know the type of signal received.

**Safety Alert System Detection** — alerts you to the presence of potential road hazards, approaching emergency vehicles, and busy railroad crossings broadcast by a Safety Alert System transmission.

**City/Highway Modes** — let you minimize alerts when you are in areas that have false radar sources.

**City/Highway Selector and City/Highway Indicator** — displays which mode is currently selected.

**FAST® (False Alert Suppression Technology)** — helps prevent false alarms caused by non-traffic radar sources.

**Tutorial Mode** — lets you experience how the detector alerts you with its detection display, tones, and real voice alert to all of the different signals the detector recognizes.

---

---

**Memory Retention** — retains operational settings in memory without power, so when you turn on your detector, the settings will be the same as when you turned it off.

**Instant On or Pulse Radar Protection** — alerts you to sudden high level radar and laser signals.

Your radar/laser detector includes the following items:

- coiled power cord
- windshield bracket with suction cups
- hook and loop tape
- spare fuse
- *Questions and Answers About Vehicle Speed Detection*

We recommend you record your detector's serial number here. The number is on the detector's bottom panel.

Serial Number: \_\_\_\_\_

**Important:** Some areas have laws regulating the use of radar detectors. Check with your local law enforcement agency about the laws in your area.

# CONTENTS

---

---

<b>A Quick Look .....</b>	<b>6</b>
Safety Alert System .....	7
<b>Installation .....</b>	<b>8</b>
Selecting a Mounting Location .....	8
Mounting Guidelines .....	8
Windshield Mounting .....	9
Hook-and-Loop Mounting .....	11
<b>Connecting Power .....</b>	<b>12</b>
<b>Operation .....</b>	<b>13</b>
Turning On the Detector .....	13
Adjusting the Volume .....	13
Tutorial Mode .....	14
Starting the Tutorial Mode .....	14
Selecting the Demonstration for Each Alert ...	14
Finishing the Tutorial Mode .....	15
Operation Settings .....	15
Selecting the City and Highway Modes .....	15
Selecting Display Brightness .....	16
Muting the Audio Alert .....	17
Selecting VG-2 Mode .....	17
Receiving and Identifying Radar, Laser, and Safety Alert Signals .....	18
<b>Troubleshooting .....</b>	<b>20</b>
<b>Care And Maintenance .....</b>	<b>22</b>
Replacing the Fuse .....	23
<b>FCC Statement .....</b>	<b>25</b>

# A QUICK LOOK

---

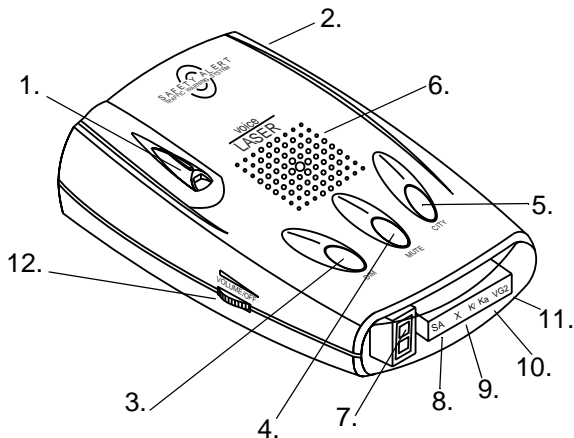

1. **360° Laser Eye** — receives incoming laser signals directed at your vehicle from all directions.
2. **DC 12V Jack** — the power cord plugs in here.
3. **DIM Button** — controls the brightness of your detector's single digit display.
4. **MUTE Button** — silences the alert tone and voice alert for about 20 seconds.
5. **CITY (City/Highway) Button** — switches between the city and highway modes.
6. **Speaker** — sounds digital voice alert.

- 
- 
7. **Single Digit Display** — indicates city/highway mode, signal strength, safety alert, and laser alert.
  8. **SA Indicator** — displays when the detector detects the safety alert signals. (See “Safety Alert System.”)
  9. **X (X-Band Radar) Indicator** — displays when the detector detects an X-band radar signal.
  10. **K/Ka (K/Ka Band Radar) Indicator** — displays when the detector detects either a K- or Ka-band radar signal.
  11. **VG-2 Indicator** — lights when a VG-2 signal is detected.
  12. **VOLUME/OFF Control** — turns the detector on and off and lets you adjust the volume.

## **SAFETY ALERT<sup>®</sup> SYSTEM**

The Safety Alert System employs low-powered transmitters used by some emergency services and road crews to alert drivers to hazardous road conditions. The system can indicate stationary, moving, or railroad hazards.

The system has the potential to dramatically decrease the occurrence of traffic accidents by increasing drivers' awareness of local road hazards. Having this safety alert compatible radar/laser detector will ensure that you are ready to benefit from this system wherever it is in use.

# INSTALLATION

---

---

## SELECTING A MOUNTING LOCATION

For the best performance, select a location for the detector where it has a direct view of the road. The detector's radar antenna is at the opposite end from the display.

**Note:** Though the detector has a 360° laser and radar detection range, the radar detection is more sensitive in the front range.

### Mounting Guidelines

Follow these guidelines when selecting a location.

- Choose a location that does not block the driver's view of the road.
- Mount the detector in a level position with a clear view to both the front and rear of your vehicle.
- The detector's view of the road must not be blocked by any metal object.
- Some vehicles have InstaClear® or ElectriClear® defogging windshields, which have metal coatings that block signals. General Motor's APV vans have a solar shield that keeps the vehicle cooler during the summer, but also blocks signals. A detector installed in a vehicle with any of these features will probably not detect a signal.



- 
- 
- Since window tinting reduces the received strength of laser signals, you should not mount the detector behind any tinted glass.
  - Do not mount the detector where the driver or a passenger might hit it in a sudden stop or accident.

**Caution:** However you choose to mount the detector, place it out of view when you leave the vehicle. This keeps the detector out of sight of thieves and prevents exposing it to extremely high temperatures, which can temporarily impair performance.

## WINDSHIELD MOUNTING

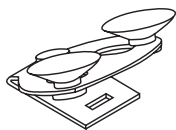

The supplied suction-cup windshield bracket lets you easily mount the detector on the windshield.

**Caution:** Do not use the bracket in a vehicle that has a plastic coating on the windshield designed to protect passengers during an accident. If you use the bracket on this type of windshield, you might permanently mar the windshield's surface. For an alternative mounting method, see "Hook-and-Loop Mounting" on Page 11.

- 
- 
1. Clean the selected windshield area, position the bracket on the windshield, and press firmly on each suction cup to secure it in place.
  2. Slide the detector onto the base plate until it snaps into place.

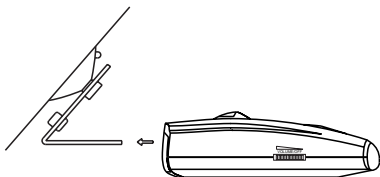

If it is necessary to adjust the mounting angle, remove the detector from the bracket, then the bracket from the windshield. Adjust the bracket by carefully bending it.

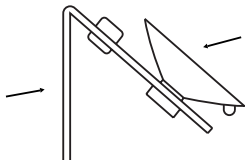

---

---

## HOOK-AND-LOOP MOUNTING

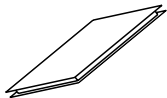

In some vehicles, the dashboard may be the best location to mount the detector. For this mounting, use the supplied hook-and-loop tape. Follow these steps to use the hook-and-loop tape.

1. Use a damp cloth to clean the bottom of the detector and the dashboard. Let both surfaces dry.

**Note:** The tape's adhesive might not stick to a surface treated with vinyl cleaner or protectant.

2. Remove the tape's backing and stick the tape to the bottom of the detector.

**Note:** Do not place the hook-and-loop tape over the detector's serial number.

On a curved dashboard, cut the supplied strip in half and use one strip on each side of the bottom of the detector.

Remove the backing from the other side of the tape and press the detector onto the dashboard.

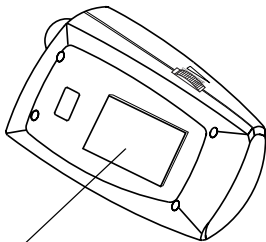

**Place the tape on the bottom of the detector**

# CONNECTING POWER

---

---

## Caution:

- Use only the supplied power cord. If your power cord is lost or damaged, you can order a replacement cord from your local RadioShack store.
- Before plugging the power cord's cigarette-lighter plug into your vehicle's cigarette-lighter socket, make sure the plug's tip is screwed firmly onto the plug. See "Replacing the Fuse" on Page 23 for more information about the cigarette-lighter plug.
- Unplug the power cord's cigarette-lighter plug from your vehicle's cigarette-lighter socket when you turn off the ignition. This prevents your vehicle's battery from being drained if you leave the detector on when you turn off the ignition.



Plug the supplied power cord's barrel plug into the detector's **DC 12V** jack. Then plug the cord's cigarette-lighter plug into your vehicle's cigarette-lighter socket.

**Note:** If the detector does not operate when you turn it on, remove the cigarette-lighter plug from your vehicle's socket and check the socket for ashes and other debris. Also, check the fuse in the cigarette-lighter plug and your vehicle's fuse block (see "Replacing the Fuse" on Page 23).

# OPERATION

---

---

## TURNING ON THE DETECTOR

To turn on the detector, rotate **VOLUME/OFF** toward **VOLUME** until it clicks. The detector will sound a tone, and will

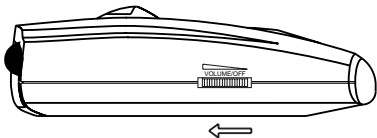

greet you with its real voice alert — “Welcome! Buckle your seat belt.” **H** appears on the single digit display to indicate the detector is in highway mode (see “Selecting the City and Highway Modes” on Page 15).

To turn off the detector, rotate **VOLUME/OFF** toward **OFF** until it clicks and all of the indicators turn off.

## ADJUSTING THE VOLUME

Rotate **VOLUME/OFF** toward **VOLUME** to increase the detector's volume, rotate it toward **OFF** to reduce the volume.

---

---

## TUTORIAL MODE

Your detector has the tutorial mode to demonstrate all of its alert indicators. In the tutorial mode, you can check the status of all the indicators and the single digit display.

### Starting the Tutorial Mode

To start the tutorial mode, turn on the detector while holding down **DIM** and **CITY**. The tutorial mode starts when the detector sounds 3 beeps and **t** appears on the single digit display.

### Selecting the Demonstration for Each Alert

To select the demonstration for each alert, press **DIM**. The detector displays each alert indicator along with its corresponding audio alert. The detector demonstrates the alerts in the order of 1 to 8 as shown below.

- |                  |                            |
|------------------|----------------------------|
| 1. X-Band Alert  | 5. Emergency Vehicle Alert |
| 2. K-Band Alert  | 6. Road Hazard Alert       |
| 3. Ka-Band Alert | 7. Rail Road Alert         |
| 4. Laser Alert   | 8. VG-2 Alert              |

When the demonstration finishes, **t** appears again on the single digit display.

---

---

## Finishing the Tutorial Mode

To finish the tutorial mode, press **CITY** at any time except when the voice alarm is operating.

## OPERATION SETTINGS

### Selecting the City and Highway Modes

Your detector has two operating modes: city and highway. In city mode, the detector requires a stronger X-, K-, or Ka-band signal before it sounds or displays an alert.

#### Notes:

- City mode helps prevent false alerts in tightly populated areas where laser/radar signals can bounce off surrounding structures.
- The city mode has no effect on laser alerts or instant-on radar.

The highway mode provides maximum sensitivity for open-road driving. The unit is pre-set to highway mode and **H** appears on the single digit display when you turn it on.

---

---

To select the city mode, press **CITY**. The voice alert says, “city mode,” and **C** appears on the single digit display.

**Note:** If you set the display brightness to dark mode, the single digit display shows only **-**. To show **C** or **H**, set the display brightness to bright or dim mode. (See “Selecting Display Brightness.”)

To return to the highway mode, press **CITY** again. The voice alert says, “highway mode,” and **H** appears on the single digit display again.

## Selecting Display Brightness

You can select from three levels of brightness for your radar detector: bright, dim, and dark.

Each time you turn on the detector, the display is pre-set to full brightness. Pressing **DIM** once reduces the display's brightness by half, and the voice alert says, “dim.” When you press **DIM** a second time, **-** appears on the single digit display and the voice alert says, “dark.” While the display is set to dark, **X**, **K/Ka**, **VG-2**, and **SA** indicators do not light during an alert. Pressing **DIM** a third time returns the display to full brightness and the voice alarm says, “bright.”



---

---

## Muting the Audio Alert

While the detector sounds a radar or safety alert signal, you can press **MUTE** to temporarily silence the detector. When you press **MUTE**, the voice alert says, “mute on.” The detector automatically resets the mute to off about 20 seconds after the radar or safety alert signal stops. Or, you can simply press **MUTE** again before it resets, and the voice alert says, “mute off.”

**Note:** Laser alert signals are not affected by pressing **MUTE**.

## Selecting VG-2 Mode

VG-2 mode is pre-set to off. To turn on VG-2, hold down **MUTE** until the voice alarm says, “VG-2 on.” To turn VG-2 off, hold down **MUTE** until the voice alarm says, “VG-2 off.”

---

---

## RECEIVING AND IDENTIFYING RADAR, LASER, AND SAFETY ALERT SIGNALS

When your detector senses a radar signal, **X** or **K/Ka** appear on the display depending on which band is detected; it sounds an alert tone for the type of band detected; and the single digit display shows the signal strength in numeric form.

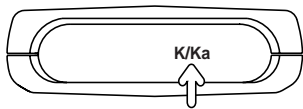
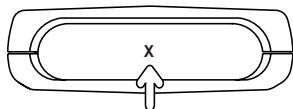

**Note:** The closer you get to the source of the radar, the higher the signal strength number increases.

When your detector senses a laser signal, **L** flashes on the single digit display and the detector sounds the laser alert tone.

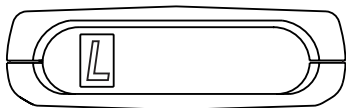

---

---

For radar signal detection, if the signal strength number goes higher than 3, the voice alert says, “X-band detected,” “K-band detected,” or “Ka-band detected,” respectively.

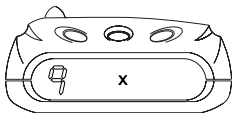

When your detector senses a safety alert signal, **SA** appears on the display; **E** (emergency band), **h** (road hazard alert), or **r** (railroad warning) flashes on the single digit display; and the corresponding voice alert says, “Caution, emergency vehicle,” “Caution, road hazard,” or “Caution, moving train” depending on the type of signal received.

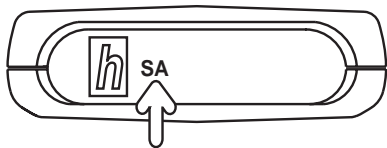
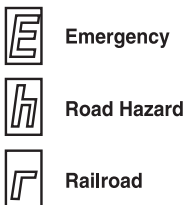

When **VG-2** is detected, **VG-2** appears on the display; the **VG-2** alert tone sounds; and the voice alert says, “VG-2 detected.”

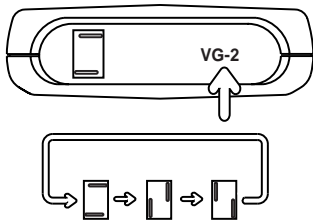

# TROUBLESHOOTING

---

---

If you have problems operating your detector, the suggestions in this section might help. If you cannot solve the problem after trying these suggestions, take your detector to your local RadioShack store for assistance.

<b>Problem</b>	<b>Suggestion</b>
The detector does not turn on.	Be sure all power connections are secure.
	The cigarette-lighter socket might be dirty. Clean it with fine emery cloth to ensure a good, clean connection.
	Check the fuse in the power cord's cigarette lighter plug. See "Replacing the Fuse" on Page 23.
	Check the fuse that controls power to your vehicle's cigarette-lighter socket. See your vehicle's owner's manual.
<b>Caution:</b> Do not place any metal object other than the cigarette lighter or cigarette-lighter plug in the cigarette-lighter socket. Doing so could blow a fuse in your vehicle or cause the metal object to become very hot.	

Problem	Suggestion
<p>The detector gives a false alert when you use vehicle accessories such as power windows, motorized mirrors, brakes, and so on.</p>	<p>Check the vehicle's electrical system for loose connections, including the main battery cable and alternator connections.</p>
	<p>Install a filter capacitor (1000 <math>\mu</math>F, 35 volts, such as RadioShack Cat. No. 272-1032) on the back of the cigarette lighter socket, across the power connections.</p>
<p>The detector performs the self-test, but does not respond to radar signals when you see a police car.</p>	<p>A police car might not be equipped with radar (see the supplied booklet, <i>Questions and Answers About Vehicle Speed Detection</i>).</p>
	<p>Police might be using VASCAR-type speed detection (see the supplied booklet, <i>Questions and Answers About Vehicle Speed Detection</i>).</p>
<p>The detector has poor laser detection range.</p>	<p>Be sure the laser detection lens is not blocked.</p>
	<p>Be sure the detector is properly mounted. See "Selecting a Mounting Location" on Page 8."</p>
	<p>Use lens-cleaning solution to clean the laser detection lens.</p>

# CARE AND MAINTENANCE

---

Your RadioShack Talking 360° Laser/Radar Detector is an example of superior design and craftsmanship. The following suggestions will help you care for your detector so you can enjoy it for years.

- Keep the detector dry. If it gets wet, wipe it dry immediately. Liquids might contain minerals that can corrode the electronic circuits.
- Keep the detector away from dust and dirt, which can cause premature wear of parts.
- Handle the detector gently and carefully. Dropping it can damage circuit boards and cases and can cause the detector to work improperly.
- Wipe the detector with a damp cloth occasionally to keep it looking new. Do not use harsh chemicals, cleaning solvents, or strong detergents to clean the detector.

Modifying or tampering with the detector's internal components can cause a malfunction and might invalidate its warranty. If your detector is not performing as it should, take it to your local RadioShack store for assistance.

---

---

## REPLACING THE FUSE

If the detector stops operating, follow these steps to check the fuse in the power cord's cigarette lighter plug and replace it with a 2-amp,  $1\frac{1}{4} \times \frac{1}{4}$ , fast-acting fuse (Cat. No. 270-1007), if necessary.

**Caution:** Using a fuse that does not meet the requirements listed above can damage your detector, the power cable, or the vehicle's electrical system.

1. Turn the knurled ring on the power cord's cigarette lighter plug counterclockwise to unscrew it.

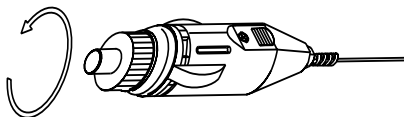

**Caution:** If you must use pliers to loosen the ring, be careful not to crush the ring or the metal tip inside the ring.

2. Remove the ring and tip from the power cord's cigarette lighter plug, then remove the old fuse.

**Note:** Take care not to lose the ring or tip, or the spring inside the plug.

3. Check the fuse. If it has blown, replace it.

- 
- 
4. Replace the metal tip inside the ring, make sure the spring is intact, then place the fuse inside the cigarette-lighter plug and screw the ring back onto the plug. Make sure the tip is visible when you reassemble the cigarette-lighter plug.

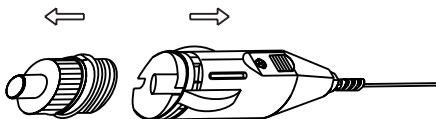

**Caution:** Never use pliers or other tools to retighten the ring on the cigarette-lighter plug.



# FCC STATEMENT

---

---

This device complies with Part 15 of the FCC Rules. Operation is subject to the following two conditions: (1) this device may not cause harmful interference, and (2) this device must accept any interference received, including interference that may cause undesired operation.

Changes or modifications not expressly approved by RadioShack may cause interference and void the user's authority to operate the equipment.

# NOTES

---

---



## Limited One-Year Warranty

This product is warranted by RadioShack against manufacturing defects in material and workmanship under normal use for one (1) year from the date of purchase from RadioShack company-owned stores and authorized RadioShack franchisees and dealers. EXCEPT AS PROVIDED HEREIN, RadioShack MAKES NO EXPRESS WARRANTIES AND ANY IMPLIED WARRANTIES, INCLUDING THOSE OF MERCHANTABILITY AND FITNESS FOR A PARTICULAR PURPOSE, ARE LIMITED IN DURATION TO THE DURATION OF THE WRITTEN LIMITED WARRANTIES CONTAINED HEREIN. EXCEPT AS PROVIDED HEREIN, RadioShack SHALL HAVE NO LIABILITY OR RESPONSIBILITY TO CUSTOMER OR ANY OTHER PERSON OR ENTITY WITH RESPECT TO ANY LIABILITY, LOSS OR DAMAGE CAUSED DIRECTLY OR INDIRECTLY BY USE OR PERFORMANCE OF THE PRODUCT OR ARISING OUT OF ANY BREACH OF THIS WARRANTY, INCLUDING, BUT NOT LIMITED TO, ANY DAMAGES RESULTING FROM INCONVENIENCE, LOSS OF TIME, DATA, PROPERTY, REVENUE, OR PROFIT OR ANY INDIRECT, SPECIAL, INCIDENTAL, OR CONSEQUENTIAL DAMAGES, EVEN IF RadioShack HAS BEEN ADVISED OF THE POSSIBILITY OF SUCH DAMAGES.

Some states do not allow limitations on how long an implied warranty lasts or the exclusion or limitation of incidental or consequential damages, so the above limitations or exclusions may not apply to you.

In the event of a product defect during the warranty period, take the product and the RadioShack sales receipt as proof of purchase date to any RadioShack store. RadioShack will, at its option, unless otherwise provided by law: (a) correct the defect by product repair without charge for parts and labor; (b) replace the product with one of the same or similar design; or (c) refund the purchase price. All replaced parts and products, and products on which a refund is made, become the property of RadioShack. New or reconditioned parts and products may be used in the performance of warranty service. Repaired or replaced parts and products are warranted for the remainder of the original warranty period. You will be charged for repair or replacement of the product made after the expiration of the warranty period.

This warranty does not cover: (a) damage or failure caused by or attributable to acts of God, abuse, accident, misuse, improper or abnormal usage, failure to follow instructions, improper installation or maintenance, alteration, lightning or other incidence of excess voltage or current; (b) any repairs other than those provided by a RadioShack Authorized Service Facility; (c) consumables such as fuses or batteries; (d) cosmetic damage; (e) transportation, shipping or insurance costs; or (f) costs of product removal, installation, set-up service adjustment or reinstallation.

This warranty gives you specific legal rights, and you may also have other rights which vary from state to state.

RadioShack Customer Relations, 200 Taylor Street, 6th Floor, Fort Worth, TX  
76102

12/99