

**INSTRUCTION MANUAL**

**ZANUSSI**

**COMBINATION OVEN**

**ZMB 32 CT**



# Contents

	<u>Page</u>
<b>Before using your combination oven</b>	4
<b>Safety Instructions</b>	
General	5
Suitable ovenware	5-6
Food safety	6-7
Safety instructions when cooking by grill	7
<b>Unpacking</b>	8
<b>Installation Instructions</b>	8
Electrical connections	9
<b>Description of the Oven Parts</b>	10
<b>Accessories</b>	11
<b>Control panel</b>	12
<b>Display window</b>	13
<b>“At a glance” operating instructions</b>	14
<b>Cooking functions</b>	15
<b>Before using the appliance</b>	
Cleaning	15
Setting the clock	15
<b>Operating instructions - Microwave only</b>	
How to program microwaves	16
Notes on microwave power levels	16
Automatic defrost	17
Automatic cooking	17
Combining automatic defrost and automatic cooking	17
<b>Convection</b>	18
<b>Thermal grilling</b>	19
<b>Grilling</b>	20
<b>Combined Microwave and Convection</b>	21
<b>Combined Microwave and Thermal grilling</b>	22
<b>Combined Microwave and Grilling</b>	23
<b>Pre-selecting cooking duration/end time</b>	24
<b>Storing a programme in the memory</b>	25
<b>Minute Timer with alarm</b>	25
<b>Microwave tables</b>	26-27
Practical tips for use	28
Tips on microwaving	28
<b>Baking Table</b>	29
<b>Thermal Grilling Table</b>	30
<b>Grilling Table</b>	31
<b>Care and Cleaning</b>	32
<b>Service and Spare Parts</b>	33
<b>Guarantee Conditions</b>	34
<b>Technical Data</b>	34

# **Congratulations on the purchase of your new combination oven**

Thank you for choosing a Zanussi product.

We are confident that you will find your new combination oven very useful and that it will be of great help to you. As with all new kitchen appliances, it will take some time to learn all the new functions and features, but with time, this oven will become indispensable to you.

## **Before using your combination oven**

Read through the instruction manual carefully.

The following instructions have been prepared to ensure you can get the best from your new Zanussi combination oven.

Please make sure you read them carefully.

It is important that this instruction book is retained with the appliance for future reference. Should the appliance be sold or transferred to another owner, or if you move house and leave the appliance, always ensure that the book is supplied with the appliance so that the new owner can be acquainted with the functioning of the appliance and the relevant warnings.

Please ensure you have read the whole instruction book before using the appliance and that you follow the recommendations given.

# Safety instructions

## General

- Install or locate this oven only in accordance with the installation instructions found in this manual.
- Use the appliance for its intended use as described in this manual. Do not use corrosive chemicals in this appliance. This type of oven is specifically designed to heat, cook and defrost food. It is for domestic use only; it is not designed for industrial, laboratory, or commercial use as this will invalidate the guarantee.
- To avoid damaging your microwave oven, **never operate it empty or without the turntable**. If food or water is not present to absorb the microwave energy, the magnetron tube can be damaged.
- The built-in safety interlock switches prevent the combination oven from operating when the door is open. Do not tamper with the safety interlock switches or attempt to operate the oven with the door open as this can result in exposure to microwave energy.
- Do not force the turntable to rotate by hand. This may cause malfunctioning.
- It is dangerous for anyone except qualified service engineers to service or make adjustments to this oven. Contact your nearest authorised Zanussi Service Force centre should service be required.
- It is particularly important that the oven door closes properly and that there is no damage to the : door (warped), hinges and latches (broken or insecure), door seals and sealing surface. Do not operate the oven if damaged until it has been repaired by qualified service personnel.
- Do not allow food spills or cleaner residue to accumulate on door sealing surfaces. See the Care and Cleaning section for cleaning instructions.
- Do not remove the outer case, door or control panel at any time. Doing so may cause exposure to extremely high voltage. Only trained personnel can carry out any repair which involves removal of these parts.
- Do not store this appliance outdoors.
- Do not use this product near water.
- Do not attempt to dry clothing or newspapers in the combination oven. These items can ignite.
- Do not use the cavity for storage purposes. Do not leave paper products, cooking utensils, or food in the cavity when not in use.
- **WARNING :**  
Do not allow children to use the microwave oven without supervision.

- Arcing in the oven during microwave operation usually occurs from use of metallic utensils. Continuous arcing, however, can damage the unit. Stop the programme and check the utensil. Ensure that any aluminium foil used is suitable for microwave cooking.
- Care should be taken not to obstruct any air vents located on the top, rear, side and bottom of the oven.

## Suitable ovenware

- Before use, **make sure that the containers are appropriate** for microwave usage. Most glass, glass ceramic and heat-resistant glassware utensils are excellent for use in the combination oven. Although microwave energy will not heat most glass and ceramic items, these utensils can become hot as heat transfers from the food to the container. Use oven gloves to remove dishes.
- Place the cookware in the microwave along with a glass half full of water. Heat on high for one minute. If the cookware feels hot, you should not use it. If it is just slightly warm, you can use it for reheating but not for cooking. If the dish is at room temperature, it is suitable for microwave cooking.
- Paper napkins, wax paper, paper towels, plates, cups, cartons, freezer wrap and cardboard are great convenience utensils. Use only food wraps recommended for microwave use. Always be sure containers are filled with food to absorb energy and thus avoid the possibility of overheating. Do not use such containers made from recycled material.
- Many plastic dishes, cups, freezer containers and plastic wraps, providing they are not made from recycled materials, may be used in the microwave oven. Follow manufacturer's instructions when using plastics in the oven. Avoid using plastic utensils with foods that have high fat or sugar content since these foods reach high temperatures and could melt some plastics. Use only food plastic wraps recommended for microwave use.
- Do not leave the oven unattended, and check from time to time when heating or cooking food in plastic, paper or other combustible containers. If smoke is observed, keep door closed, and switch the oven off until smoke stops.
- Metal utensils and utensils with metallic trim should not be used in the microwave oven, unless specifically recommended for microwave use.
- Containers with restricted openings, such as bottles, should not be used for microwave cooking.
- Take care when removing a lid or cover from a dish to avoid steam burns.

# Safety instructions

- Shallow foil containers may safely be used to reheat foods in your microwave oven providing the following rules are observed :
  1. Foil containers should not be more than 3cm (1 1/4") deep.
  2. Foil lids must not be used.
  3. The foil container must be at least two-thirds full.
  4. Foil containers should be used singly in the microwave oven and should not be allowed to touch the sides. If using the metal cooking rack, the foil container should be placed on an upturned non-metallic ovenproof plate. There should be no metal to metal contact during the microwave cooking process.
  5. Foil containers should never be re-used in the microwave oven.
  6. If the microwave oven has been in use for 15 minutes or more, allow it to cool before using it again.
  7. The container and turntable may become hot during use, take great care when removing either from the oven.
  8. Remember when using an aluminium foil container that the reheating or cooking times may be longer than you are accustomed to; always ensure that the food is piping hot before serving.

Note : please find a comprehensive list of containers which are suitable for use in convection, grill, microwave and combination functions below :

## Food safety

- The basic rules to remember when reheating foods are : cover, stir, turn where possible, and allow standing time. Always cook food until it is piping hot throughout.
- Do not heat food in a can in the microwave oven. Always place in a suitable container.
- When warming :
  - **baby bottles**, be sure to **remove the teat**, **shake the liquid** and **test the temperature** on the back of your hand **before feeding**.
  - **children's foods**, it is essential to stir and **verify the temperature** before consumption to avoid serious internal burns.
- **Do not heat or cook boiled, coddled eggs or fried eggs**. They can burst and cause serious burns or damage to your oven.
- It is necessary to cover foods in most cases, to keep in the heat and moisture. They will be tastier and your oven will stay cleaner. However, airtight containers should not be used in the oven.

## Suitable ovenware

Ovenware Material	M o d e o f o p e r a t i o n			
	Microwave	Hot air	Thermal Grilling	Combination
Ovenproof glass and ceramic (without any metal, e.g. pyrex oven to tableware)	YES	YES	YES	YES
Non ovenproof glass and porcelain ex. table crockery, without metal deco	YES	NO	NO	NO
Ovenproof earthenware	YES	YES	YES	YES
Plastic, heat resistant up to 200°C	YES	YES *	NO	YES *
Paper	YES	NO	NO	NO
Microwave cling film	YES	NO	NO	NO
Roasting bag	YES	YES *	NO	YES *
Metal cooking containers	NO	YES	YES	NO
Metal baking tins	NO	YES	NO	NO
Wire shelf	YES	YES	YES	YES
Oven-proof glass dish	YES	YES	YES	YES
Baking tray	NO	YES	NO	NO

\* Please note the maximum temperature stated by the manufacturer

# Safety instructions

- **To prevent liquids from boiling over, wait 20 seconds** before adding anything to boiling liquids, or removing them from the oven.
  - For small amounts (one sausage, a single croissant, etc.), place a glass of water alongside the food item.
  - **Time settings that are too long may dry out and burn the food.** To avoid such incidents, never use the same cooking times as for traditional ovens.
  - Do not do deep fat frying in the microwave oven. The fat temperature cannot be controlled, hazardous situations can result.
  - Popcorn may be prepared in the microwave oven, but only in special packages or utensils designed specifically for this purpose. This cooking operation should never be unattended.
  - Pierce foods with non-porous skins or membranes to prevent steam build-up and bursting. Apples, potatoes and chicken livers are examples of items that should be pierced.
  - Food items with plenty of moisture or liquid such as casseroles and soups, can be safely heated on full power, whereas vegetables, puddings, plated and prepared chilled meals are best reheated more gently, on low setting, until they are piping hot throughout.
  - Always follow the cooking advice given on the package when reheating or cooking commercially prepared foods including cook-chill dishes. However, it is essential to adjust cooking times when necessary to ensure that food is piping hot throughout before serving.
  - Take particular care when reheating food items such as mince pies, Christmas pudding and sausage meat which have a high sugar or fat content and absorb microwave energy very quickly.
  - The starting temperature of the food will affect the reheating time. Refrigerated food will take longer than food at room temperature.
  - Stir foods such as soups, drinks, sauces, casseroles, milk puddings, or wherever possible to ensure they heat evenly.
  - Large items which cannot be stirred, for example lasagne, shepherd's pie, are best reheated on a lower power setting to allow the center to become thoroughly heated without overheating the outer edges.
  - Large items such as jacket potatoes should be turned halfway through cooking to help even reheating.
  - Arrange plates of food to be reheated with thicker food to the outer edge and with delicate foods such as thin slices of meat in the center.
  - To give a more freshly cooked appearance it is often better to reheat the sauce or gravy separately.
  - Underestimate reheating times for the first time, then check that the food is heated thoroughly. You can always put it back in the oven, but once it is overheated it is spoilt.
  - Reheating does improve some foods, for example, bread freshens up beautifully in the microwave, and casseroles improve their flavour with reheating.
  - Pastry needs only brief reheating on microwave mode to prevent it becoming soggy.
- WARNING :** when heating liquids, e.g. soups, sauces and beverages in your microwave oven, overheating the liquid beyond boiling point can occur without evidence of bubbling. This could result in a sudden boilover of the hot liquid. To prevent this possibility, the following steps should be taken :
1. Avoid using straight-sided containers with narrow necks.
  2. Do not overheat.
  3. Stir the liquid before placing the container in the oven and again halfway through the heating time.
  4. After heating, allow to stand in the oven for a short time, stirring again before carefully removing the container, using an oven glove.

## Safety instructions when cooking by grill

- The glass viewing window may break if water is spilled on it during grilling.
- Containers, the turntable and metal rack get very hot in the oven. Use an oven glove when loading and unloading the oven.
- Do not touch the inner or outer viewing window with metal components when loading or unloading the oven. The inside of the door and oven get very hot so take care when attending food in the oven.
- Do not put the turntable or containers in cold water or try to cool them quickly after use.
- Note : it is quite normal for steam to be emitted around the door, or for misting to occur on the door, or even for water droplets to appear below the door during the cooking cycle. This is merely condensation from the heat of the food and does not affect the safety of your oven. The door is not intended to seal the oven cavity completely.

**It is important that this instruction book should be retained with the appliance for future reference.**

# Unpacking

When you unpack the oven, check that the product is free from damage (deformed door, etc.). Damage or any missing parts must be reported immediately to the retailer. Dispose of packing material safely and keep away from children.

## Installation Instructions

- Remove any labels from the door.
- The oven should be installed on a flat, level surface, away from any direct source of heat or steam, and at least 85 cm above ground. The surface must be strong enough to safely bear the weight of the oven and the contents. To avoid the possibility of causing vibration or noise, the oven must be in a stable position.
- Do not block air vents on the top and sides of the cabinet and do not place any articles on the top of the oven, to avoid overheating.
- Place the oven as far away from radios and TV's as possible.
- This oven can be used as a free standing oven or built-into a kitchen cabinet. Detailed below is a guide to the building in dimensions. Detailed assembly instructions are supplied with the building in kit.

- If used as a free-standing appliance, make sure that air circulates freely around the oven.

Leave sufficient space around the oven :

- 5 cm between the sides of the oven and any objects
- 20 cm above the oven
- 10 cm behind the oven.

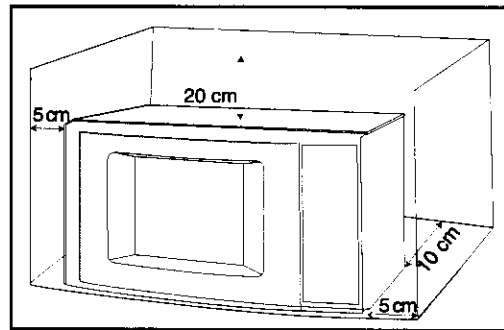

This appliance conforms to the requirements of EEC radio interference directive 87/308/EEC.

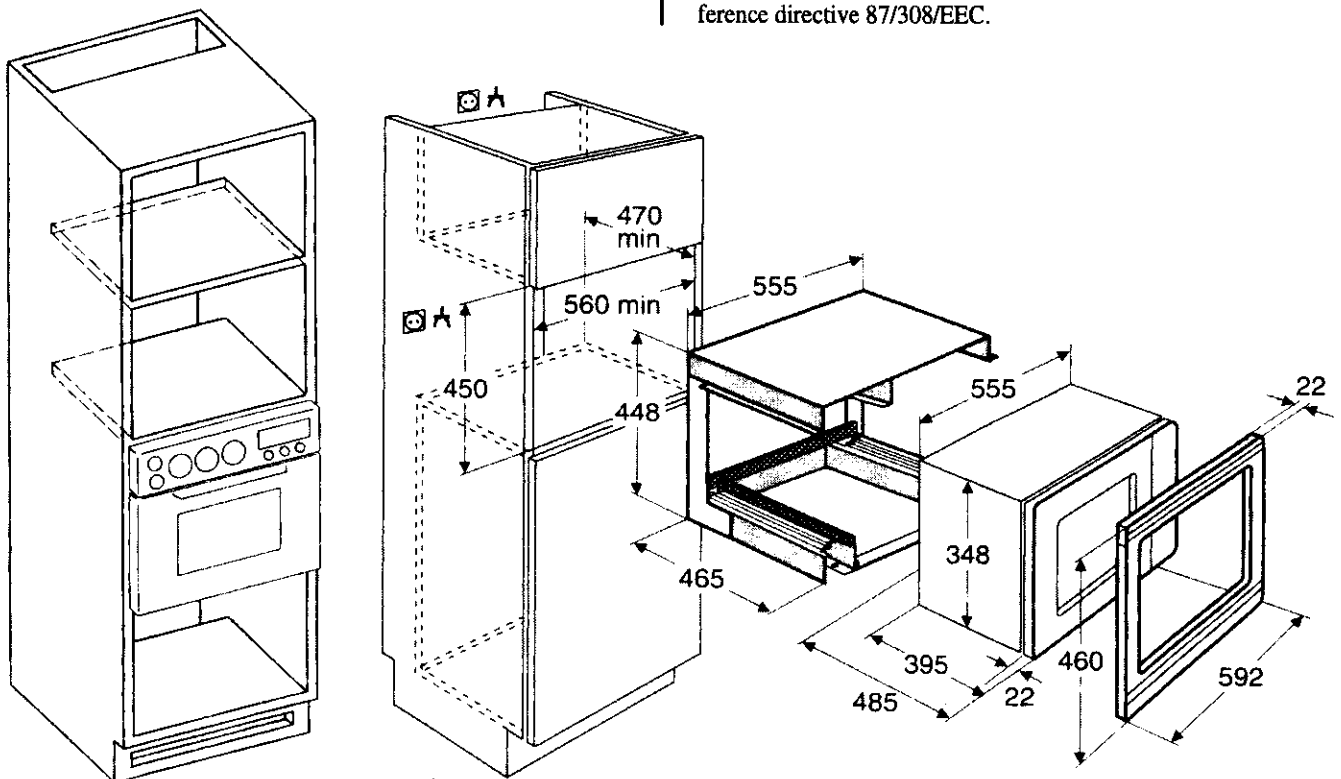



**Electrical connections - UK**

- Check the power voltage. If there is a PERMANENT under-voltage, consult your electrical installer.
- Your installation must be protected by a thermal fuse 13 Amp (UK), 10 Amp (AUS & NZ).
- In your electrical installation, provide a device that is accessible to the installer, capable of separating the appliance from the mains power and whose contact opening is at least 3 mm at all of the poles.
- Never operate the oven if the supply cord or its plug are damaged. **In this case, call in a specialized technician trained by the manufacturer.**

**WARNING ! THIS APPLIANCE MUST BE EARTHED.**

The manufacturer declines any liability should this safety measure not be observed.

If the plug that is fitted to your appliance is not suitable for your socket outlet, it must be cut off and the appropriate plug fitted.

Remove the fuse from the cut off plug. The cut off plug should then be disposed of to prevent the hazard of shocks in case it should be plugged into a 13 Amp socket in another part of your home.

**IMPORTANT**

The wires in the mains lead are coloured in accordance with the following code:

GREEN AND YELLOW	EARTH
BLUE	NEUTRAL
BROWN	LIVE

If you fit your own plug, the colours of the wires in the mains lead of your appliance may not correspond with the markings identifying the terminals in your plug; proceed as follows:

Connect the green and yellow (earth) wire to the terminal in the plug which is marked with the letter "E" or the earth symbol ( $\equiv$ ) or coloured green and yellow.

Connect the blue (neutral) wire to the terminal in the plug which is marked with the letter "N" or coloured black.

Connect the brown (live) wire to the terminal in the plug which is marked with the letter "L" or coloured red.

The plug moulded onto the lead incorporates a fuse. For replacement, use a 13 Amp BS1362 fuse. Only ASTA or BSI approved fuses should be used.

The plug must not be used if the fuse cover/carrier is lost. The cover/carrier is indicated by the coloured insert at the base of the plug. A replacement cover/carrier must be obtained from your local Zanussi Service Centre.

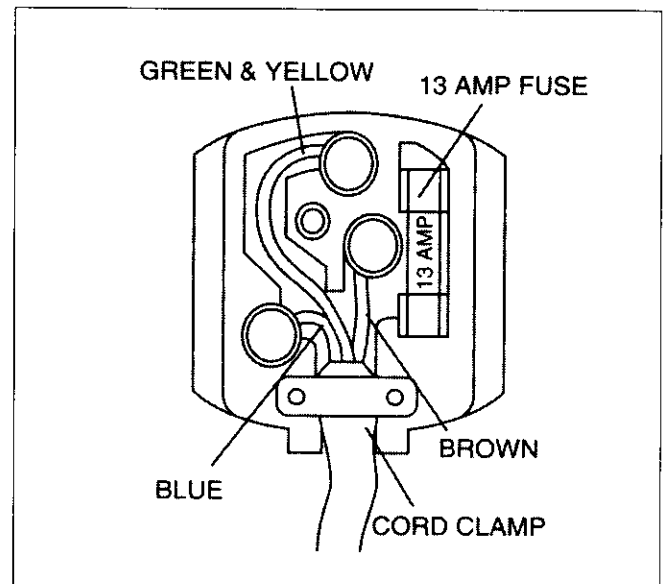

# Description of the Oven Parts

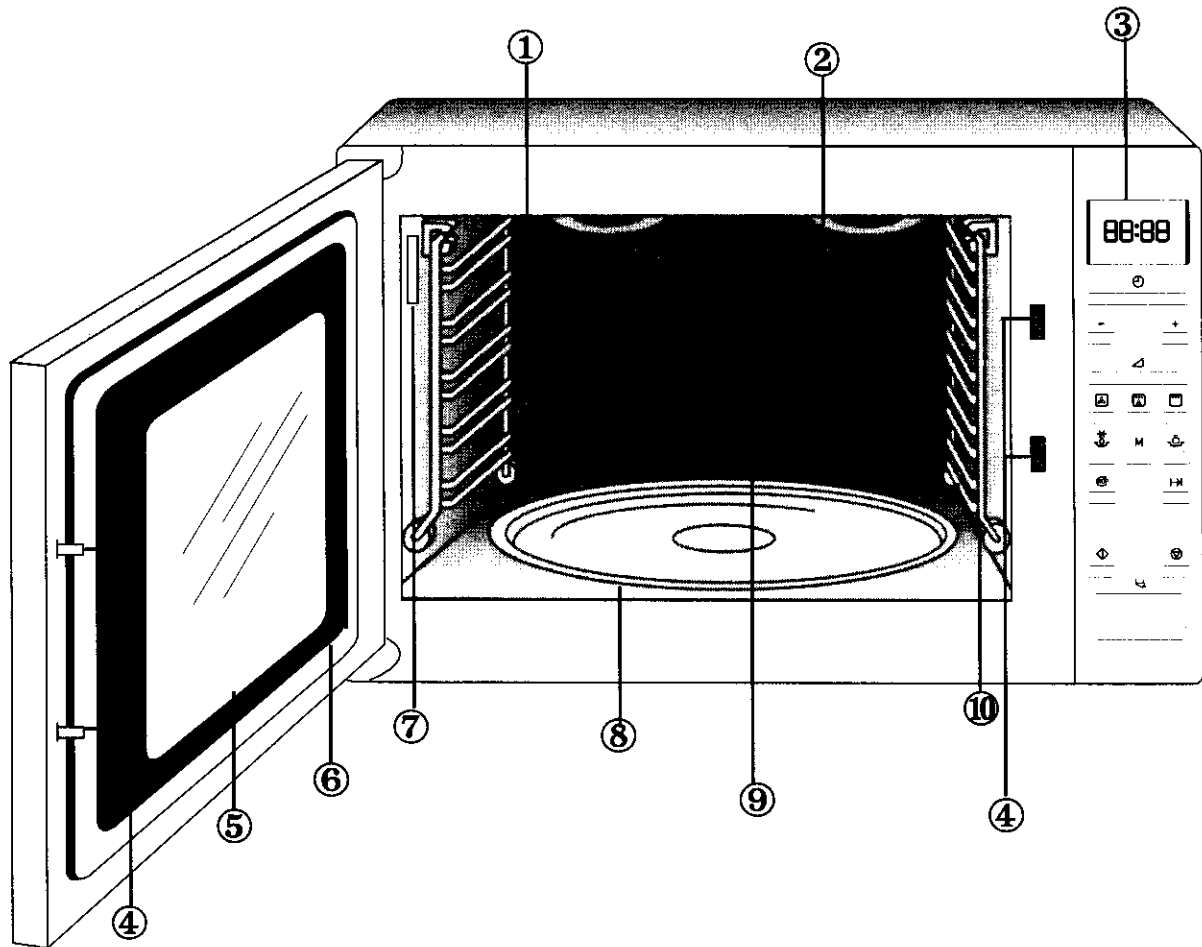

- |                               |                             |
|-------------------------------|-----------------------------|
| ① Microwave distributor cover | ⑥ Door seal                 |
| ② Grill heater                | ⑦ Oven light                |
| ③ Control Panel               | ⑧ Turntable                 |
| ④ Door locks                  | ⑨ Convection fan and heater |
| ⑤ Oven window                 | ⑩ Removable shelf rack      |

# Accessories

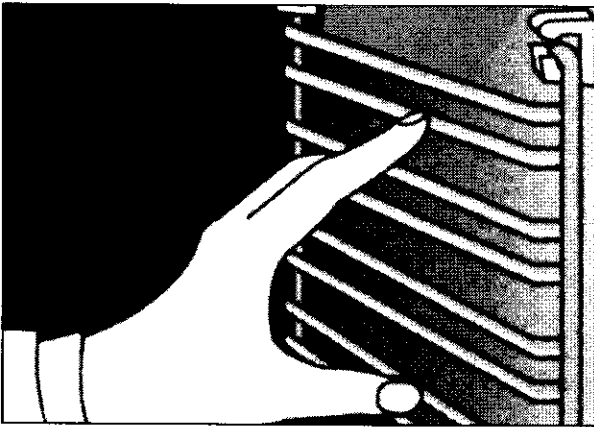

## 2 Shelf racks

Hang the rack in place at the top as shown, then clip the base into the side wall, in order to have 9 shelf levels available.

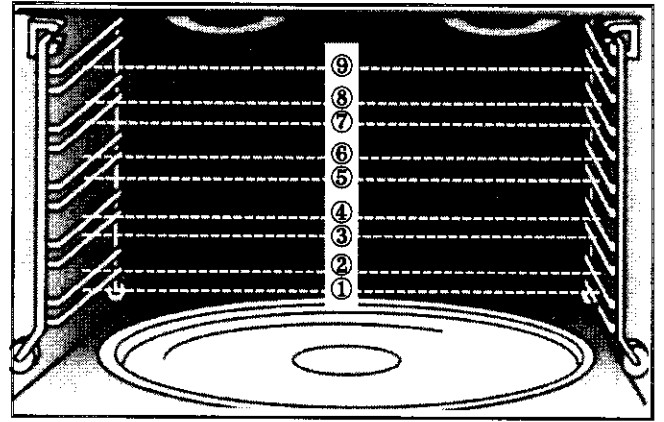

## **This appliance has 9 shelf levels.**

Depending on the mode of operation and accessories required, adjust the shelf level according to the instructions given in the tables.

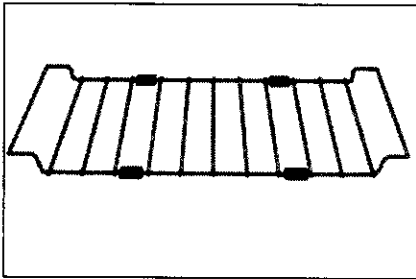

## Wire shelf

For grilling meat and poultry, for au gratin dishes or toasting.

Always place over either the oven-proof glass dish or the baking tray

**DO NOT USE BY ITSELF !**

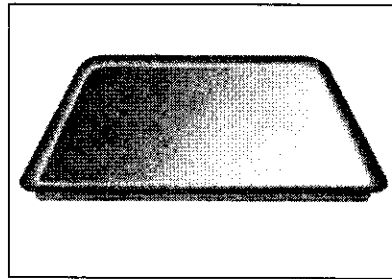

## Oven-proof glass dish

This general purpose oven-proof glass dish can be used as a fat drip-tray, for roasting any dishes with cooking juices, as well as for puddings.

9 possible levels

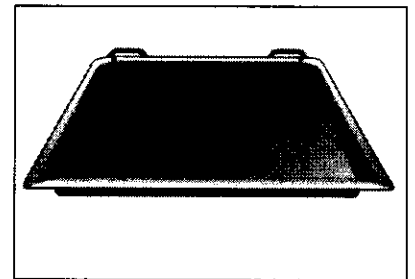

## Baking tray

For cakes, pastries and biscuits. When sliding into position, make sure that a space is kept between the tray and the rear wall.

To be used only level 1

# Control panel

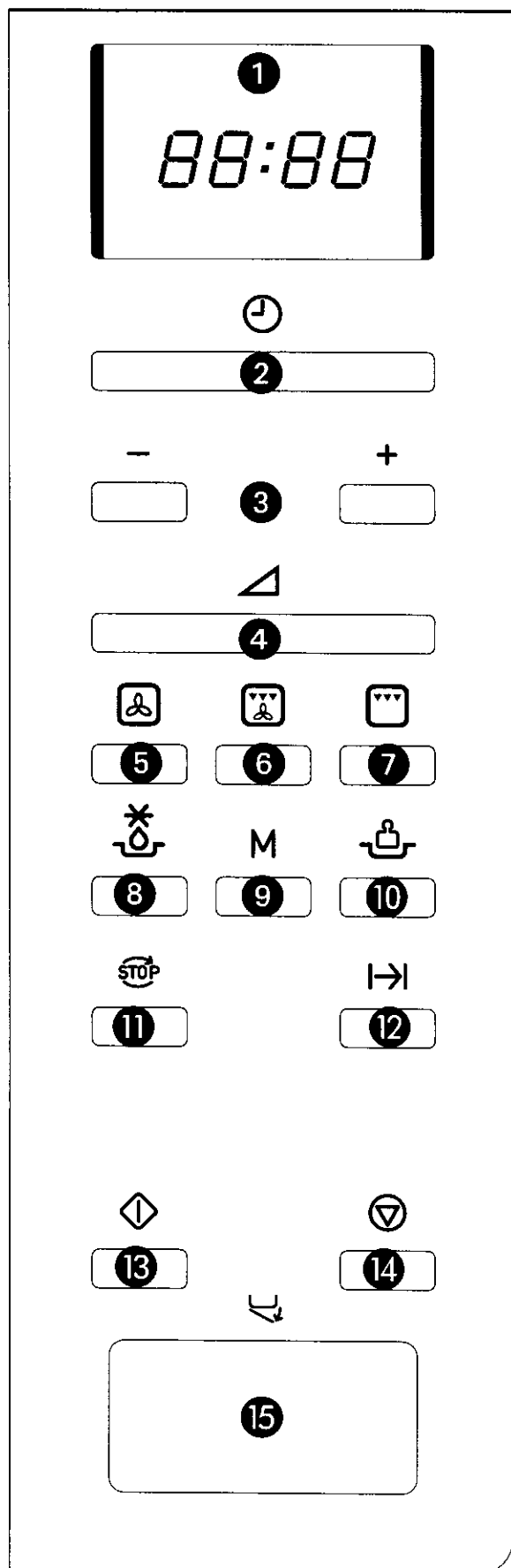

- ① **Fluorescent display :**  
indicates time of day, cooking time and other oven features
  
- ② **Keypad for setting clock**
  
- ③ **Keypads for increasing/decreasing :**  
e.g. time, temperature
  
- ④ **Keypad for selecting power level**
  
- ⑤ **Keypad for selecting convection mode**
  
- ⑥ **Keypad for selecting thermal grilling**
  
- ⑦ **Keypad for selecting grilling**
  
- ⑧ **Keypad for selecting automatic defrost**
  
- ⑨ **Keypad for storing a program in memory**
  
- ⑩ **Keypad for selecting automatic cooking**
  
- ⑪ **Keypad for switching the turntable off**
  
- ⑫ **Keypad for programming cooking duration / end time :**
  
- ⑬ **To start selected operations**
  
- ⑭ **Clear key :**  
to clear all information or interrupt an operation.
  
- ⑮ **Door opening key**

# Display window



## Symbols :

**00:00**

indicates time of day, cooking time and other oven features



Microwave only



Turntable off



Automatic defrost





Automatic cooking



Minute timer with alarm

**000°** [

Temperature display

50 - 250°C for   
50 - 200°C for  & 



Temperature control light (stays illuminated until the selected temperature has been reached)



Pre-selection of programme duration/end time

**1**

Selected Memory programme



Grill









Thermal grilling



Convection

# “At a glance” operating instructions

Action	Comments
1. Press door open key.	The door opens and the interior light switches on.
2. Place food in the cooking space.	
3. Shut the door. If the door is not shut properly the appliance will not function.	The door will click audibly when it is properly shut.
4. Select according to the instructions given in the following pages.	IMPORTANT : Always select the time duration first.
5. If required : switch off the turntable by pressing the turntable off key  ).	When the turntable has been switched off the symbol  lights up. The turntable should only be turned off when using rectangular ovenware that is larger than the turntable and is in danger of jamming.
6. Press the start key  .	The appliance starts. The light in the cooking area comes on. The display shows the selected cooking time, counting down in seconds. The symbol representing the chosen cooking function lights up.
7. End of cooking sequence <sup>2)</sup> .	The end of the cooking sequence is indicated by an audible tone. The appliance and the interior light switch off. The display area once again shows the time of day.
8. During the cooking sequence :  8.1 Open the door by pressing the door open button e.g. for stirring.  Shut the door and press the start  key.  8.2 Press the cancel key  once.  8.3 Press the  key twice.  8.4 Press key for microwave power  .	The appliance switches off. The cooking area light stays on. The display flashes with the appropriate mode of operation. The selected settings remain. The remaining time counts down automatically.  All cooking sequences (including the automatic programmes) will be momentarily interrupted.  The operating functions will be cancelled. The display will show the time of day.  The output level will briefly show on the display.

## Note :

- 1) If you want to switch off the turntable during operation, you will need to interrupt the process by pressing the clear key  twice, and then follow steps 4, 5 and 6 again.
- 2) At the end of a microwave cooking sequence, if power level “P5” or higher was selected then a keeping warm level will automatically switch on for a maximum of 15 minutes. The display will show “ H:H ”. When this keeping warm time finishes, the display will switch back to showing the time of day. The keeping warm process will be interrupted if the oven door is opened. It cannot be switched on separately.

# Cooking Functions

## The appliance features the following functions :

### Microwave only

In this mode, microwaves generate heat directly in the food. This mode is highly suitable for warming, for example, ready-cooked food and drinks, the defrosting of meat or vegetables, and for cooking food such as fish and vegetables.

### Convection

The air inside the oven is heated by the element around the fan in the back wall of the oven. The fan circulates hot air to maintain an even temperature inside the oven. The food is heated on all sides. Ideal for baking with a baking sheet, ceramic dish or baking tin.

### Thermal grilling

Both the fan and the grill heating elements operate at the same time. Larger pieces of meat and poultry can be grilled or roasted in this mode.

### Grilling

Heat is generated by a grilling element set in the roof of the oven. This is particularly suitable for toasting and grilling, e.g. steaks and sausages.

### Combination mode

The microwave mode can be used with either convection, thermal grilling or surface grilling. Dishes will be cooked more quickly, whilst being crisp and brown at the same time.

# Before using the appliance

## Cleaning



Wipe over the front of the appliance with a damp cloth.

Do not use abrasive cleaning agents (these can damage the surface).

Before you first use the appliance, remove all the accessories (including the turntable and turntable support) from the cooking area. Wash the accessories in warm water and washing up liquid. Wipe clean the cooking space with a soft, damp cloth.

## Setting the clock

**Example :** 12:15

1. Plug the appliance into the mains. The display starts to flash " 0:00 ".
2. Use the +/- key to enter the hour. Press the  key. The display shows " 12:00 ".
3. Use the +/- key to enter the minutes and then press the  key. The time of day will appear in the display. The appliance is now ready for use.

### Note :

This clock is a 24 hour clock, so from 23:59 it will go to 0:00. To correct the clock press the  key twice, then proceed as above.



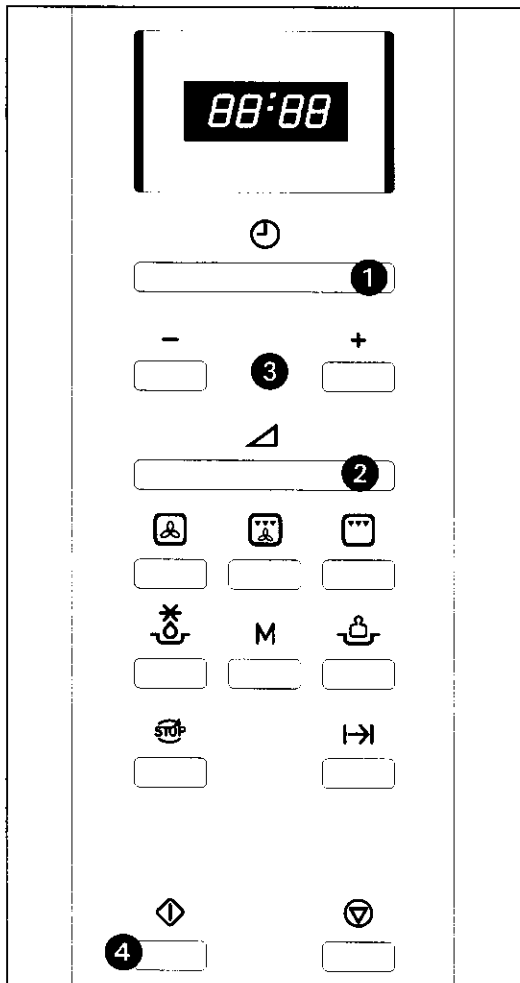

# Operating Instructions

## Microwave only

### How to program microwaves



**Example : 1 minute 15 seconds on output level "P8".**

- 1 Press the  key. The time of day disappears from the display. Set the required cooking time by pressing the "+/-" key.
- 2 Press the  key. The highest output level "P9" appears in the display. The  symbol for microwave starts flashing.
- 3 Using the "+/-" key, select the required output level.
- 4 Press the start key . The selected time starts to count down. The symbol for microwave  lights up.

#### Notes :

Times can be set as follows :

up to 30 seconds in 5 second steps

- from 30 seconds in 10 second steps
- from 1 min in 15 second steps
- from 3 min in 30 second steps
- from 6 min in 1 minute steps

Metal items must be kept at least 2 cm from the oven wall and the oven door.

### Notes on microwave power levels

The following list shows you the power settings and what they can be used for during microwave operation :

- |                      |  |
|----------------------|--|
| Setting 9 (850 Watt) | - to start a cooking sequence, to bring to the boil, start roasting, stewing, etc.           |
| Setting 8 (750 Watt) | - heating ready made meals   |
|                      | - defrosting and heating deep frozen ready made meals  |
| Setting 7 (670 Watt) | - warming delicate dishes such as : mushrooms, cheese, snails, mussels, kidney beans, butter |
| Setting 6 (580 Watt) | - heating baby food in glass jars (remove the lid)   |
|                      | - melting chocolate for coating cakes  |
| Setting 5 (500 Watt) | - simmering soups, stews, casseroles, noodles (after bringing to the boil on Setting 8/9)    |
| Setting 4 (400 Watt) |  |
| Setting 3 (300 Watt) |  |
| Setting 2 (240 Watt) | - defrosting meat, fish, fruit, bread and cakes  |
|                      | - swelling rice (after bringing to the boil on Setting 8/9)                                  |
| Setting 2 (240 Watt) | - warming cold dishes, drinks, softening butter  |
| Setting 1 (140 Watt) | - proving yeasted dough  |
|                      | - defrosting cream and butter  |
|                      | - defrosting cakes with cream or butter icing  |







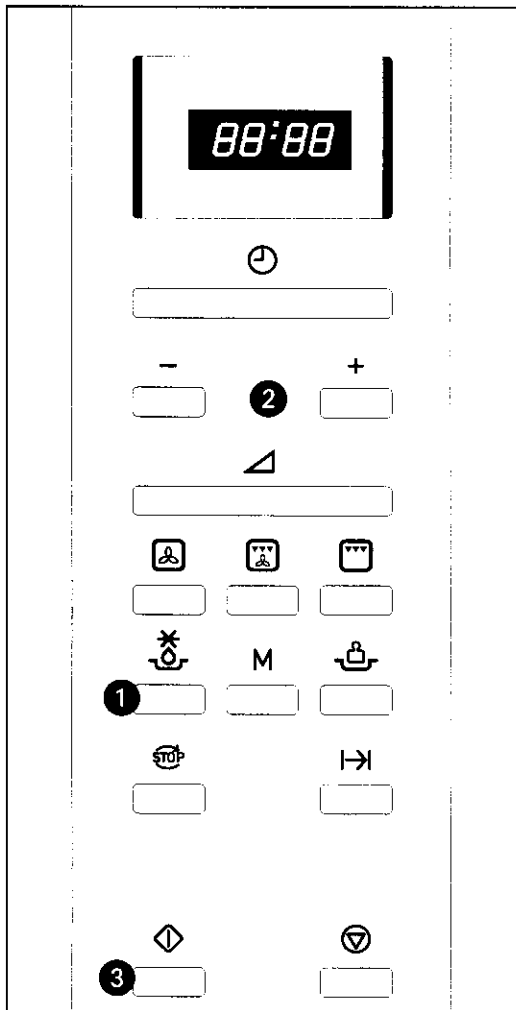

### Automatic Defrost

There are four automatic defrost programmes available. The appropriate programme is selected by pressing the  defrost key one or more times. Then the weight of the food is keyed in. The appliance will calculate the time automatically.



#### Example: 1 kg chicken

- 1 Press the  key. The time of day disappears. In the display "d1" appears and the symbol for automatic defrost  will start flashing.
- 2 Use the "+/-" key to enter the weight of the food to be defrosted.
- 3 Press the  key. The display shows the defrost time, the symbol for microwaves  and the automatic defrost symbol  will light up.

**Note :**

The following gives you examples of what food can be defrosted with which programme.

**Programme "d" Food categories**

d1	Poultry
d2	Meat
d3	Fish
d4	Delicate cakes and pastries (e.g. deep frozen cream cake)



### Automatic Cooking

There are eight automatic cooking programmes. Press the  key one or more times to select the appropriate programme, then enter the weight of the food to be cooked.

**Note :**

The following gives you examples of what food can be cooked with which programme. (For liquids see Microwave table on page 27)

<u>Programme "C"</u>	<u>Food categories</u>	<u>Max. weight in grams</u>
C 1	Chicken/potatoes	4000
C 2	Root vegetables, cabbage, peas, broad beans, etc.	3400
C 3	Beef - rare / medium	3300
C 4	Simmering of meat sauces and casseroles	1400
C 5	Lamb - rare / re-heating liquids	3400
C 6	Lamb - medium / fish fillets	4000
C 7	Lamb - well done / whole fish	3700
C 8	Pork / frozen ready meals	3000

### Combining Automatic Defrost and Automatic Cooking

You can select both automatic functions one after the other. Select the automatic defrost programme and enter the weight of the food. **Do not press the start key.** Set the automatic cooking programme (select programme and enter weight).

Now press the start key .



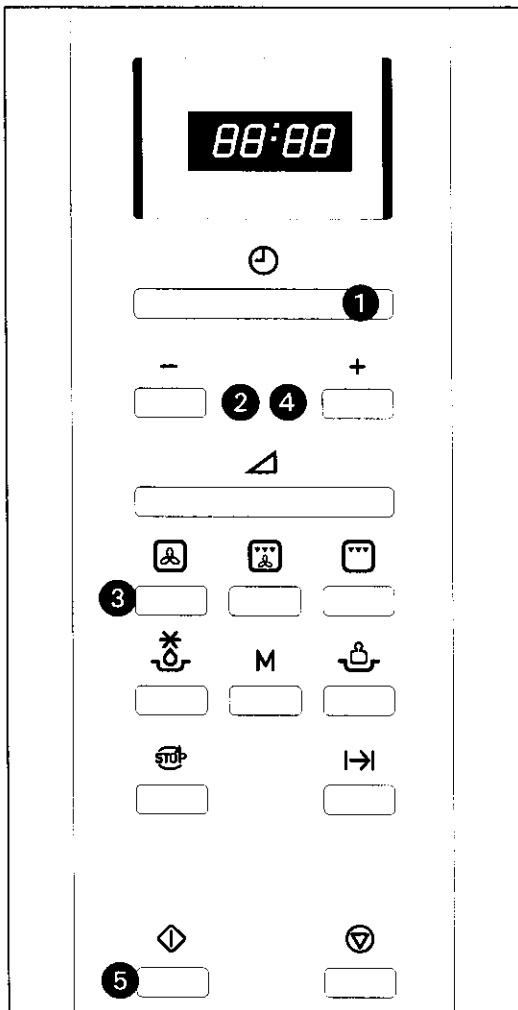

At the end of the defrosting time, the appliance will automatically switch over to the cooking programme.

# Convection

## How to program



**Example : 20 minutes at 170 °C**

- ① Press the  key. The time of day disappears.
- ② Set the required cooking time using the “+/-” key.
- ③ Press the  key. The pre-set time and the temperature “150 °C” will show in the display. The convection symbol  will start to flash.
- ④ Set the temperature to 170° using the “+/-” key.
- ⑤ Press the start key . The pre-set time will start to count down. The symbol for convection  lights up.

**Note :**

Convection mode can be used without a pre-set cooking time, e.g for pre-heating the oven; simply begin at Step 3.

# Thermal Grilling

## How to program

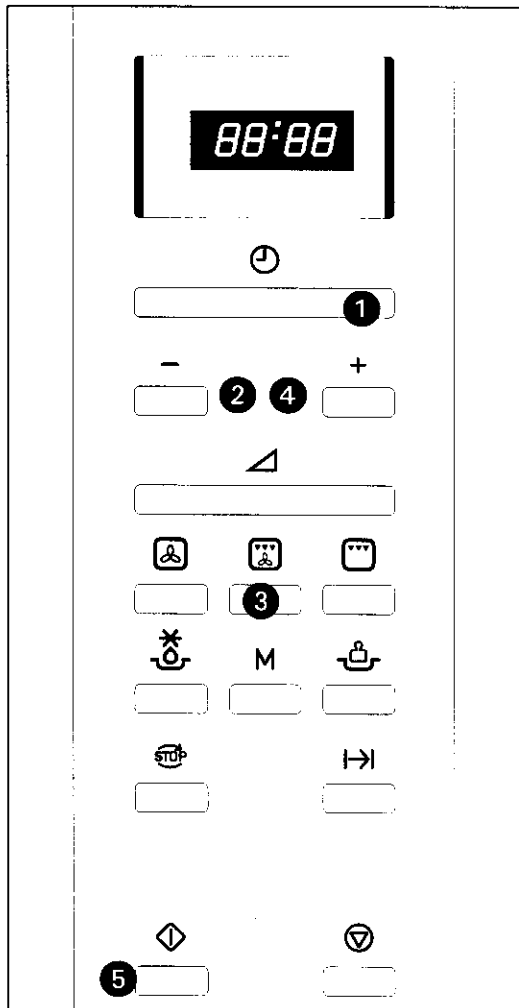

### Example : 20 minutes at 190 °C

- ① Press the ⌚ key. The time of day disappears.
- ② Set the required cooking time using the "+/-" key.
- ③ Press the 🔥 key. The pre-set time and the temperature " 180 °C " will show in the display. The thermal grilling symbol 🍷 will start to flash.
- ④ Set the required temperature using the "+/-" key.
- ⑤ Press the start key ▶ . The pre-set time will start to count down. The thermal grilling symbol 🍷 lights up.

### Hints :



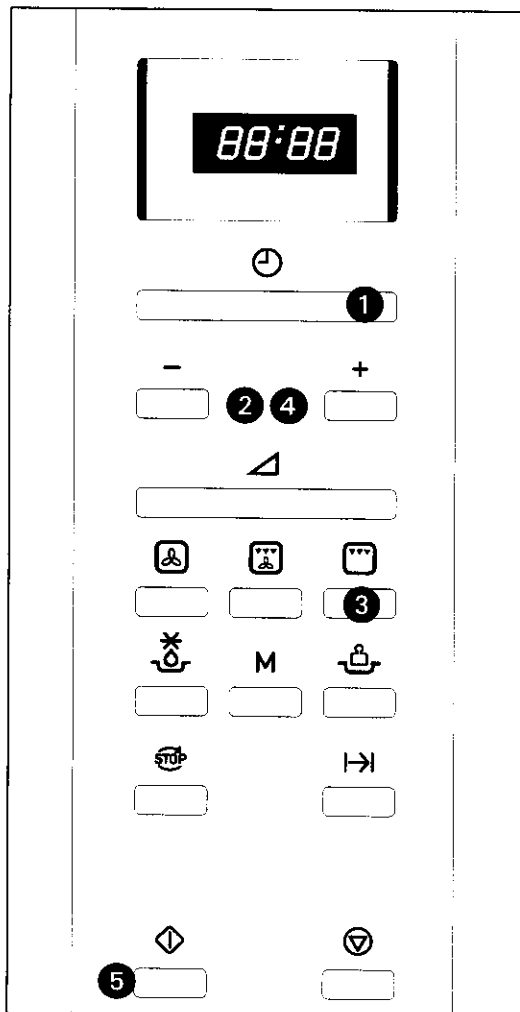

Thermal grilling can be used without a pre-set time, e.g. for pre-heating the oven; simply begin at Step 3.

# Grilling

## How to program



**Example : 4 minutes at 190 °C**

- ① Press the  key. The time of day disappears.
- ② Set the required cooking time using the “+/-” key.
- ③ Press the  key. The pre-set time and the temperature “200 °C” will show in the display. The grilling symbol  will start to flash.
- ④ Set the required temperature using the “+/-” key.
- ⑤ Press the start key . The pre-set time will start to count down. The symbol for grilling  lights up.

**Note :**

Preheating : simply begin at Step 3.

# Combined Microwave and Convection

## How to program

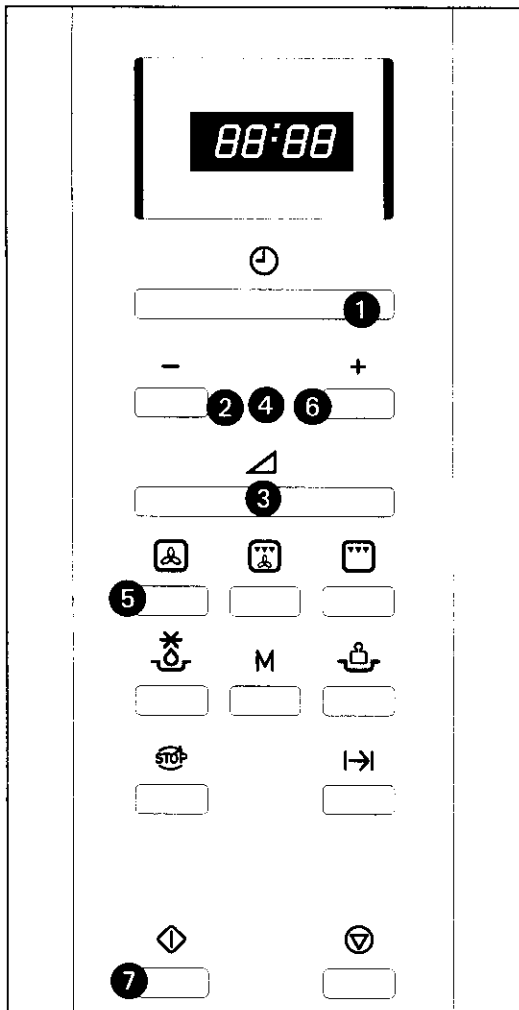

**Example : 20 minutes at 190 °C and power setting "P3"**







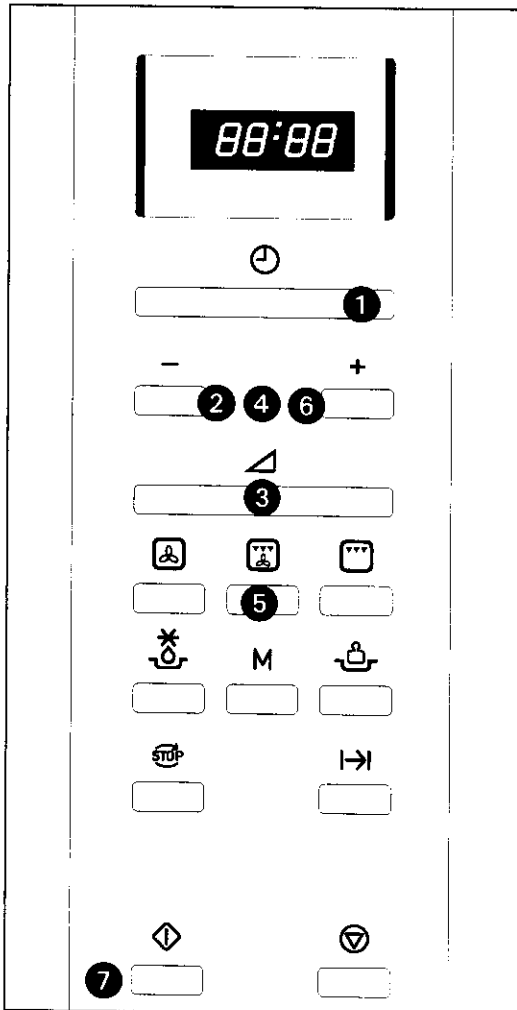

- ① Press the ⌚ key. The time of day disappears.
- ② Set the required cooking time using the "+/-" key.
- ③ Press the ▲ key. The maximum power level "P9" will appear in the display. The microwave symbol 📡 will flash.
- ④ Set the required power output using the "+/-" key.
- ⑤ Press the 🌀 key. The pre-set time and the temperature 150 °C will appear in the display. The symbol for hot-air operation 🌀 and microwaving 📡 will start to flash.
- ⑥ Set the required temperature using the "+/-" key.
- ⑦ Press the start key ▶. The pre-set time will start to count down. The symbols for convection operation 🌀 and microwaving 📡 will light up.

# Combined Microwave and Thermal Grilling

## How to program



**Example : 20 minutes at 190 °C and power setting “P3”**







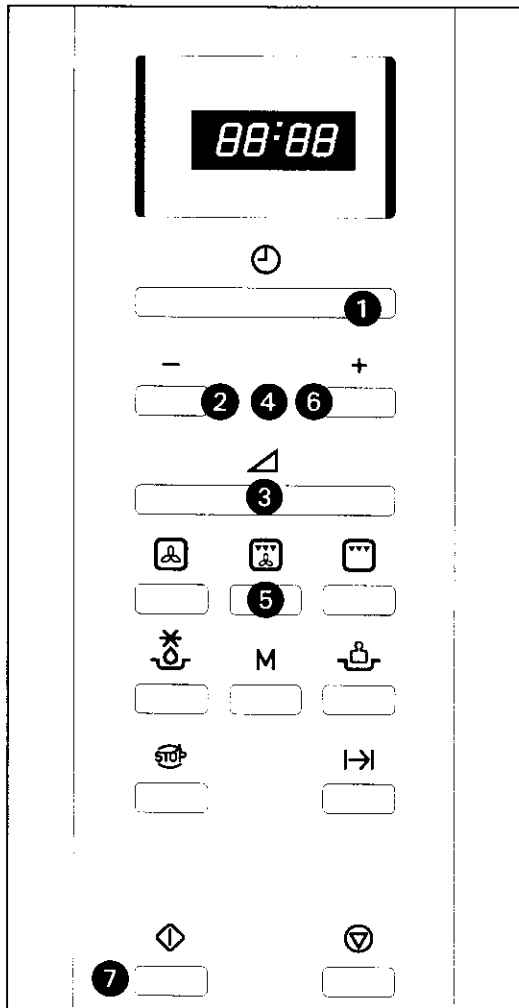

- ① Press the  key. The time of day disappears.
- ② Set the required cooking time using the “+/-” key.
- ③ Press the  key. The maximum power level “P9” will appear in the display. The microwave symbol  will flash.
- ④ Set the required power output using the “+/-” key.
- ⑤ Press the  key. The pre-set time and the temperature 180 °C will appear in the display. The symbols for microwave  and Thermal grilling  will start to flash.
- ⑥ Set the required temperature using the “+/-” key.
- ⑦ Press the start key . The pre-set time will start to count down. The symbols for microwave  and Thermal grilling  will light up.

# Combined Microwave and Grilling

## How to program



**Example : 20 minutes at 170 °C and Power setting "P6"**

- 1 Press the  key. The time of day disappears.
- 2 Set the required cooking time using the "+/-" key.
- 3 Press the  key. The maximum power level "P9" will appear in the display. The microwave symbol  will flash.
- 4 Set the required power output using the "+/-" key.
- 5 Press the  key. The pre-set time and the maximum grilling temperature 200 °C will appear in the display. The symbols for microwave  and grilling  will start to flash.
- 6 Set the required temperature using the "+/-" key.
- 7 Press the start key . The pre-set time will start to count down. The symbols for microwave  and grilling  will light up.

# Pre-selecting cooking duration / end time



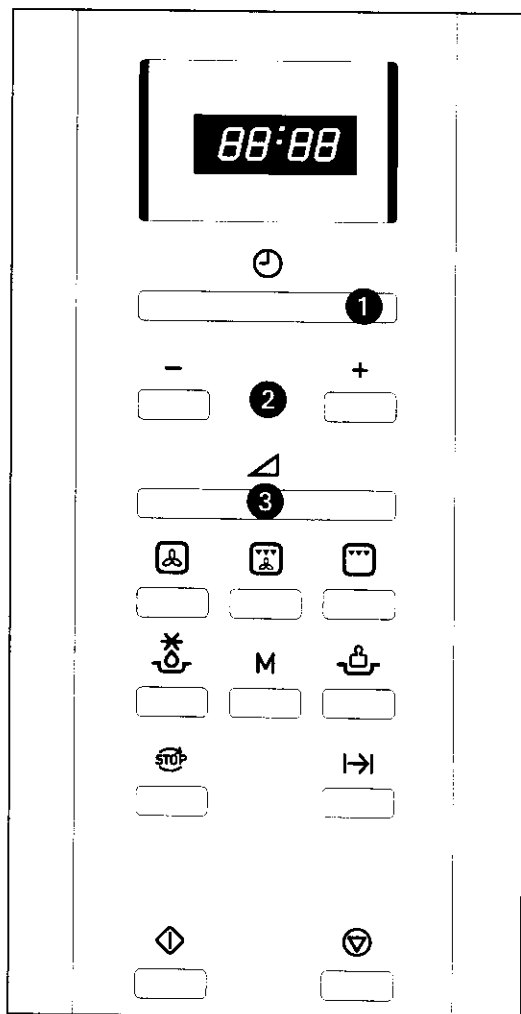

## How to program



First enter whichever cooking operation you wish to programme to turn on and off.

**Example : the appliance should switch off at 12:15 hrs**

Place the food in the appliance and - as described on the previous pages - select the chosen cooking function.

- ❶ Do **not** press the start key , but press the  key instead. The symbol  will start to flash in the display and the clock will flash "0:00".
- ❷ Now use the "+/-" key to enter the time at which the sequence is to finish.
- ❸ Press the  key. The actual time of day and the symbol for pre-selecting duration/end time  will light up.

The appliance will switch on automatically, and off again at the point in time you have determined.

### Note :

Ensure that food is inside the oven. This is particularly important when using microwave cooking only.



# Storing a programme in the memory

## How to set

You can store a programme of your own in the memory by using memory button **M**. This is ideal for storing a programme which is frequently used in the household e.g boiling one cup of water. Start by following the steps required to set any one of the modes of operation described on the previous pages.

- 1 Do not press the start key, but instead press the memory key **M**. The symbol for the memory programme **1** lights up in the display.
- 2 Then press key  once in order to confirm the programme you have just entered. The time of day will then reappear in the display.

## Calling up

- 1 Press the memory button **M**. The display shows the setting programmed for the mode of operation. The symbol for the relevant mode of operation starts to flash and the selected programme lights up in the display.
- 2 Press the  key. The symbols for the mode of operation light up and the time starts to count down in seconds.

### Note :

If you store a new programme, you will wipe out the old programme completely.



The programmes you have entered will also be deleted if there is a power failure. It is therefore advisable to make a note of it, so that it is not lost completely.



# Minute Timer with Alarm

## To program

The minute timer with alarm can also be used as a useful reminder for other things. For example, you could use it to set the time it takes to boil the egg that you are cooking on the hob.

The timer works without switching on the appliance, as long as no other functions have been selected.

- 1 Press the  key. The time of day disappears. Use the '+/-' key to select the length of time required.
- 2 Press the  key. The highest power setting "P9" appears in the display. The symbol for microwave  flashes.

- 3 By holding down the "-" key select "PO". The symbol for microwave  disappears and the  symbol for the timer will flash.
- 4 Press the  key. An audible signal will sound when the timer has finished counting down.

# Microwave Tables

<b>Defrosting</b>					
<u>Description</u>	<u>Weight</u> grams	<u>Power</u> △	<u>Duration</u> min	<u>Standing</u> time min	<u>Remarks / Hints</u>
<b>Meat</b>					
Small joint of meat	500	2 - 3	10 - 12	10 - 15	Turn once. Cover fatty parts with aluminium foil after 1st half of defrosting time.
Steak	200	2 - 3	3 - 4 1/2	5 - 10	Turn once during defrosting in oven.
Mixed chopped meat	500	2 - 3	10 - 15	5 - 10	Remove defrosted chopped meat after 10 min.
Goulash	500	2 - 3	10 - 12	8 - 13	“ “
<b>Poultry</b>					
Chicken	1000	2 - 3	20 - 25	10 - 20	During defrosting time in oven turn once. Cover legs with aluminium foil after 1st half of defrosting time.
Duck	1500 - 2000	2 - 3	25 - 35	20 - 30	As for chicken.
<b>Fish</b>					
Whole fish	500	1 - 2	8 - 12	15 - 20	Turn once during defrosting time in oven. Cover fins with aluminium foil if desired.
Shrimp s/ Crab	250	1 - 2	4 - 6	15 - 20	Stir thoroughly after half defrosting time.
<b>Dairy Produce</b>					
Cottage cheese	500	1 - 2	18 - 25	15 - 20	Divide and stir frozen cottage cheese pieces from time to time.
Butter	250	1	3 - 5	15 - 20	First remove any aluminium foil wrapping.
Cheese	250	1	3 - 5	20 - 30	“ “
Cream	200ml	1	4 - 7	15 - 20	Stir from time to time.
<b>Fruit</b>					
Strawberries, red currants, cherries, damsons, apricots	500	1 - 2	8 - 10	10 - 15	Defrost in a covered container. During defrost time in oven, stir once.
Raspberries	250	1 - 2	4 - 6	10 - 15	Defrost in a covered container.
<b>Bread</b>					
Rolls	4	1	3 - 4	5 - 10	Turn once whilst defrosting in oven.
Wholemeal, mixed, rye	1 slice	1	1/2 - 1 1/2	5 - 7	Defrost individual slices in a covered container.
Loaf	60 - 80 g 500	1 - 2	6 - 8	10 - 20	Cover cutting surface.
<b>Cakes</b>					
Dry cakes e.g. cakes with short crust pastry	300	1 - 2	3 - 4	5 - 10	Defrost cakes uncovered on a serviette or plate.
Fruit flans on baking sheet	400 - 450	1 - 2	3 - 4	5 - 10	As for dry cakes.
1 slice cheese cake	400	1 - 2	9 - 12	10 - 15	“ “
1 slice covered apple tart	400	1 - 2	8 - 10	10 - 15	“ “
Cream and butter cream layer cakes	300 - 400	1	5 - 6	30 - 60	Only start defrosting of cakes in the appliance.
<b>Melting food</b>					
Chocolate / toppings	100	5 - 6	2 - 4	2 - 3	Stir from time to time.
Butter	50	6 - 7	1/2 - 1	1 - 2	To warm set time for 1 minute longer.

# Microwave Tables

<b>Heating of refrigerated food and drink</b>						
<u>Description</u>	<u>Weight</u> grams	<u>Power</u> △	<u>Duration</u> min	<u>Standing</u> time min	<u>Remarks / Hints</u>	
1 jar baby food	125 - 250	5 - 6	1/2 - 2	2 - 3	Heat jar without lid. Stir after warming.	
1 ready meal on a plate	350 - 400	8 - 9	2 - 3	2 - 3	Heat in covered container. Place gravy alongside in a cup.	
1 portion meat	150 - 175	8 - 9	1 - 2	2 - 3	All meat, except breaded, should be heated in a covered container.	
1 portion vegetables / potatoes / rice	200	8 - 9	1 1/2 - 2 1/2	2 - 3	Heat in covered container.	
Soup					Heat clear soup uncovered, cover thick soups.	
<b>Drinks</b>						
Milk or baby food	200 ml	7 - 8	1/2 - 1	1 - 2	Remove any lids, stir after warming.. Check the temperature before serving !	
Boil 1 cup of water	180 ml	9	1 1/2 - 2 1/2	1 - 1 1/2	Stir instant coffee or tea after approx. 1/2 minute, when the water has stopped boiling vigorously.	
1 cup milk	200 ml	9	1/2 - 2 1/2	1 - 1 1/2	Heat milk till it is just hot enough to drink.	
1 cup coffee (reheat)	150 ml	9	1/2 - 2 1/2	1 - 1 1/2		
<b>Defrosting &amp; reheating of frozen convenience foods</b>						
1 portion meat with gravy	150 - 175	8 - 9	3 - 5	3 - 5	Turn or stir now and again.	
1 portion meat with vegetables, garnish	300 - 450	8 - 9	8 - 15	3 - 5	Stir once before serving.	
<b>Cooking fish</b>						
Fish fillets	500	8 - 9	7 - 9	2 - 3	Cook covered.	
Whole fish	1000	1. 8 - 9 2. 5 - 6	4 - 5 8 - 10	2 - 3	Cover during cooking, cover flat parts with aluminium foil.	
<b>Cooking vegetables</b>						
<u>Description</u>	<u>Weight</u> grams	<u>Liquid</u> <u>added</u>	<u>Power</u> △	<u>Duration</u> min	<u>Standing</u> time min	<u>Remarks / Hints</u> <i>Cook all vegetables covered</i>
Cauliflower	500	1/8 l	8 - 9	6 - 9	2 - 3	Top with butter.
Frozen broccoli	300	1/8 l	8 - 9	6 - 9	3 - 4	Stalks facing outwards.
Mushrooms	250	--	8 - 9	4 - 5	2 - 3	Cut into slices.
Frozen peas & carrots	300	1/2 cup	8 - 9	7 - 9	2 - 3	
Carrots	250	1/2 cup	8 - 9	8 - 10	2 - 3	Cut into cubes or slices.
Potatoes	250	2 - 3 tsp.	8 - 9	4 - 5	2 - 3	Peel and quarter.
Kohlrabi	250	1/2 cup	8 - 9	7 - 8	2 - 3	Cut into spikes or slices.
Red / green peppers	250	--	8 - 9	5 - 6	2 - 3	Cut into strips or pieces.
Leeks	250	1/2 cup	8 - 9	4 - 6	2 - 3	Cut into rings or pieces.
Frozen Brussels sprouts	300	1/2 cup	8 - 9	7 - 9	2 - 3	
Sauerkraut	250	1/2 cup	8 - 9	8 - 12	2 - 3	

# Microwave Tables

## Notes on the microwave tables :

*The times given are for guidance only, and are dependent on the nature and type of food being cooked.*

### Practical tips for use

#### General

- After switching off your appliance, allow food to stand inside for a few minutes (**standing time**).
- Remove any aluminium foil or metal containing packaging before preparing the food.
- Metal objects must be placed at least 2 cm away from the oven walls and door. Otherwise arcing can occur, resulting in damage to the appliance.

#### Cooking

- Whenever possible cook in covered containers. Only when a crust is desired or is to be kept, should you cook food in uncovered containers.
- Refrigerated or frozen food requires a longer cooking time.
- Foods containing sauces should be stirred from time to time.
- Cook vegetables with firm consistency such as carrots, peas and cauliflower with a little water.
- Cook vegetables with soft consistency, such as mushrooms, peppers and tomatoes without liquid.
- Increase cooking time by approximately 50% for larger pieces.
- Where possible, cut vegetables into equal-sized pieces.

#### Defrosting of meat, poultry and fish

- Place frozen, unpacked meat on an inverted plate in a glass or porcelain container, or use a plastic sieve, so that the meat juices can drain.
- Halfway through defrosting, turn the food, dividing it where possible and removing the pieces that have defrosted.

#### Defrosting of butter, pieces of layer cake and cottage cheese

- Do not fully defrost in the appliance, but leave to adjust outside. This will give a more even result.
- Remove any metal or aluminium foil packaging and/or accessories before defrosting.

#### Defrosting of fruit and vegetables

- Fruit and vegetables that are to be used raw later should not be fully defrosted in the appliance, but left to adjust outside.
- Fruit and vegetables that are to be cooked straight away can be cooked straight from frozen using a higher power level.

#### Ready made meals

- Ready meals in metal packages or plastic containers with metal lids should be heated or defrosted in your microwave oven only if they are explicitly marked as being suitable for microwave use.
- Please follow the operating instructions printed on the pack-

### Tips on microwaving

You can't find cooking details for a specific quantity of food



Take guidance from a similar type of food.  
Lengthen or shorten the cooking time accordingly :  
Double Quantity = almost Double Time  
Half quantity = Half Time

The food is too dry



Set a shorter cooking time or reduce the microwave power output.

If food is not yet defrosted, heated through or cooked on completion of cooking time















Select a longer cooking time or a higher microwave power setting. Note that larger foods will require longer cooktime.

The food is overcooked on the outside and undercooked in the middle on completion of cooking time









Next time try a lower power setting for a longer time. Stir liquids, such as soup, periodically.

# Baking Table









Description	Accessories	Shelf level from base	Microwave power 	Mode	Temperature °C	Total time min
<b>Cakes in tin</b>						
Cake mix	Baking tray	1	-		160 - 170 <i>residual heat</i>	60 - 65 5
Sponge cake	Baking tray	1	-		160 - 170	35 - 45
Cheese cake	Baking tray	1	-		160 - 170 <i>residual heat</i>	60 - 70 10
Quiche Lorraine	Baking tray	1	-		150 - 160	40 - 50
<b>Pastries on baking tray</b>						
Swiss roll <sup>1)</sup>	Baking tray	1	-		170 - 180	12 - 17
Fruit flan or tart	Baking tray	1	-		160 - 170 <i>residual heat</i>	45 - 55 5
Cakes baked in a loaf tin	Baking tray	1	-		165 - 175 <i>residual heat</i>	20 - 25 5
Pizza <sup>1)</sup>	Baking tray	1	-		240 - 250	13 - 17
Deep frozen pizza <sup>2)</sup>	Wire shelf & glass dish	2	9		200 <i>residual heat</i>	18 - 20 3 - 5
Deep frozen baguettes <sup>2)</sup>	Oven-proof glass dish	2	9		200 <i>residual heat</i>	15 - 20 3 - 5
<b>Small pastries made of puff pastry<sup>1)</sup></b>	Baking tray	1	-		170 - 180	15 - 25
Drop scones	Baking tray	1	-		150 - 170	18 - 25
1) Preheat the oven to the selected temperature 2) Refer to manufacturers instructions						

## Notes on the Baking Table :

- The range of baking temperatures and times given are for guidance only, as they are dependent upon the composition of the dough, the quantity and the baking tin size and material.
- We recommend that you start by using the lower temperature setting. Only select a higher temperature if, for example, you want to brown food more, or if the baking is taking too long.
- If you cannot find specific instructions for one of your recipes, follow the instructions for one which is similar.
- Unless otherwise stated, the settings given in the table are for use in a cold oven.
- "Residual heat" refers to leaving the cooked dish to stand for a short time in the switched off appliance.

- How can you be certain that the cake is baked through?  Insert a wooden skewer into the most risen part of the cake. If no mixture sticks to the skewer, you can switch off the oven and leave the cake in the "residual heat".
- If the cake collapses (or is soggy, spongy or watery).  Check the recipe. Use less liquid next time. Note mixing times by hand, or in particular if you have used a mixer.
- If the base of the cake is too light in colour.  Choose a darker colour baking tin next time.
- If cheesecakes/cakes with a moist filling have not cooked all the way through.  Next time choose a longer temperature and lengthen the baking time.
- If biscuits can't be removed from the tray.  Put the baking tray back in the appliance for a short time and then remove the biscuits immediately. Use baking parchment next time.
- The cake does not come out of the tin when turned upside down.  Loosen the cake from the side of the tin carefully with a knife. Turn the cake upside down again and cover the tin with a moist, cold cloth several times. Next time, grease the cake tin well and also sprinkle bread crumbs on the bottom.

# Thermal Grilling Table

<u>Description</u>	<u>Weight grams</u>	<u>Accessories</u>	<u>Shelf level from base</u>	<u>Microwave power </u>	<u>Mode</u>	<u>Temperature °C</u>	<u>Total time min</u>
<b>Meat / fish</b>							
Beef	1000	Wire shelf & glass dish	1	-		180 - 200	40 - 45
Pork	1000	Wire shelf & glass dish	2	3		150 <i>residual heat</i>	65 - 75 5 - 10
Meatloaf	750 - 1000	Wire shelf & glass dish	2	9		185 <i>residual heat</i>	20 - 25 5
Chicken	1000	Wire shelf & glass dish	2	9		200 <i>residual heat</i>	30 - 35 5 - 10
<b>Au gratin</b>							
Potatoes au gratin	1000	Wire shelf & glass dish	on turn- table	9		180 <i>residual heat</i>	50 - 55 5
Lasagne	1000	Wire shelf & glass dish	1	9		190 <i>residual heat</i>	25 - 30 5
Stuffed aubergine	1000	Ovenproof glass dish	1	9		200 <i>residual heat</i>	35 - 40 5

## Notes on the Roasting and Grilling Table :

- The range of temperatures and times given are for guidance only, as they are dependent upon the composition and size of the item being cooked, as well as the desired consistency at the end.
- Unless otherwise stated, the settings given in the table are for use in a cold oven.
- Turn the food, if possible, halfway through cooktime, so that both sides are cooked and browned evenly.
- Always place the wire shelf in the oven-proof glass dish when using the combined mode with microwave.

# Grilling Table

<u>Description</u>	<u>Weight grams</u>	<u>Accessories</u>	<u>Shelf level from base</u>	<u>Mode</u>	<u>Temperature ° C</u>	<u>Grilling time (min)</u>	
						<u>Side 1</u>	<u>Side 2</u>
<b>Meat / poultry</b>							
Sausages <sup>1)</sup>	4	Wire shelf Baking tray	4	▼▼	190 - 200	4 - 6	4 - 6
Steaks (2 - 3 cm thick)	200 each	Wire shelf Baking tray	4	▼▼	190 - 200	10 - 12	9 - 11
2 chicken legs	200 each	Wire shelf Baking tray	3	▼▼	180 - 190	12 - 15	10 - 12
<b>Fish</b>							
4 Trout	170 each	Wire shelf & glass dish	3	▼▼	190 - 200	6 - 9	5 - 8
4 Herring	200 each	Wire shelf & glass dish	3	▼▼	190 - 200	9 - 100	7 - 9
<b>Others</b>							
Toast <sup>2)</sup>	6 slices	Wire shelf & glass dish	4	▼▼	190 - 200	2 - 3	2 - 3
Toasted snacks <sup>2)</sup>	4 slices	Wire shelf & glass dish	4	▼▼	190 - 200	4 - 6	
1) First heat the oven for 2 minutes							
2) First heat the oven for 5 minutes							

## Notes on the grilling table :

- The grill temperatures and times given are for guidance only, as they are dependent upon the type and quality of the meat.
- Grilling is ideal for flat pieces of meat and fish.
- Unless otherwise stated, the settings given in the table are for use in a cold oven.
- Flat foods should be turned only once. Larger, rounder pieces should be turned more times.
- Fish are best placed head to tail on the wire shelf.
- Always place the wire shelf in either the oven-proof glass dish or the baking tray.

# Care and cleaning

The oven must always be clean. Residues of food spillage or splatters will attract microwave energy causing it to burn on. This could reduce the efficiency of the oven and may cause bad odours.

Do not attempt to tamper with or make any adjustments or repairs to any part of the oven. Repairs should only be done by a qualified service technician.

## Cleaning the interior

Be sure the oven is switched off or the unit is unplugged before cleaning.

Always keep the inside of the oven clean. Wipe up spillages and splatters immediately. Soilage that is allowed to remain on the oven walls, door seal and door surface will absorb microwave energy, reduce the efficiency of the oven, and possibly damage the oven interior.

Use mild, liquid detergent water and a soft, clean cloth to remove soilage. **NEVER USE ABRASIVE CLEANERS, COMMERCIAL OVEN CLEANERS OR STEEL WOOL PADS ON ANY PART OF THE OVEN.**

To loosen difficult soilage, boil a cup of water in the microwave oven for 2 or 3 minutes. **NEVER USE A KNIFE OR ANY OTHER SHARP UTENSIL TO REMOVE SOILAGE FROM OVEN SURFACES.** To remove odours from the oven interior, boil a cup of water plus 2 tablespoons of lemon juice for 5 minutes.

## Turntable and Turntable support

The glass turntable tray can be removed for cleaning by pressing down on the edge of one side so that the other side tilts up. Clean the turntable using washing-up liquid, or put it in the dishwasher. Clean the turntable support with washing-up liquid.

## Other accessories

The wire racks, shelves, baking tray and oven-proof glass dish should be removed immediately after use and soaked in washing-up liquid and water. Food remains can then be removed quite easily using a brush and normal washing-up liquid. The glass trays are heavy and can break if dropped. Use caution when handling them.

## Cleaning the exterior

Open the oven door when cleaning the control panel. This will prevent the oven from being turned on accidentally. You should clean outside surfaces of the oven with mild washing-up liquid and water followed by a wiping with clear water to remove any excess detergent. Dry with a soft cloth.

Spray-on window cleaners or all purpose spray-on kitchen cleaners can also be used. Never use abrasive cleaners, scouring pads or harsh chemicals on the outside surfaces of your oven. To prevent damage to the working parts, do not allow water to seep into ventilation openings.



# Service and spare parts

## ...the microwave oven is not working properly?

Check that

- the appliance is connected correctly
- the fuses in the fuse cupboard are working
- there has not been a power cut.

If the fuses continue to blow, please contact a qualified electrician.

## ...the microwave mode is not working?

Check that

- the door is properly closed,
- no food debris or anything else is jammed in the door,
- the door seals and their surfaces are clean,
- controls are set correctly, the start key has been pressed.

## ...you cannot enter any settings?

Check that the time of day has been set.

## ...the letter "E" shows on the display?

There has been an error. Press  key to cancel and re-enter the settings.

## ...the display is showing "E 15"?

The appliance is still hot from recent use. Leave the appliance to cool for a while, then try again.

## ...the turntable is not turning?

Check that

- the turntable support is correctly attached to the drive,
- the turntable is switched on,
- the ovenware is not overlapping the turntable,
- food is not sticking over the edge of the turntable preventing it from rotating.

## ...the food is taking longer to heat through and cook than before?

- set a longer cooking time (double quantity = nearly double time) or
- if the food is colder than usual, rotate or turn from time to time or
- set a higher power setting.

## ...the microwave will not switch off?

Isolate the appliance from the fuse box.

Contact ZANUSSI Service Force, or your local dealer.

## ...the interior light is not working?

Call ZANUSSI Service Force. The interior light bulb can be exchanged only by trained ZANUSSI engineers.

If after all these checks, the oven still does not work, contact your local ZANUSSI Service Force Centre quoting the model number and serial number. This information can be found on the rating plate located on a foil label on the back of the appliance.

We suggest you make a note below so that you have the details readily available :

Model : ZMB 32 CT

Serial number : \_\_\_\_\_

Date of purchase : \_\_\_\_\_

**In-guarantee customers should ensure the above checks have been made as the engineer will charge if the fault is not a mechanical or electrical breakdown.**

**Please note that proof of purchase will be required for any in-guarantee service calls.**

To contact your local Zanussi Service Force Centre telephone :

**0990 929929**

Your call will be automatically routed to the Service Centre covering your post code area. Further information can be found in the accompanying Customer Care booklet and also in your local telephone directory under "Z".

Spare parts can be purchased from Zanussi Service Centres.

### UK CUSTOMER CARE

For general enquiries regarding your Zanussi appliance, or for further information on Zanussi products, you are invited to contact our Consumer Care Department by letter or telephone as follows:

Customer Care Department  
Zanussi Ltd.  
Zanussi House  
Hambridge Road  
Newbury  
Berkshire  
RG14 5EP  
Tel: (01635) 521313

# Guarantee Conditions

## STANDARD GUARANTEE CONDITIONS

We, Zanussi Limited, undertake that if within 24 months of the date of the purchase this Zanussi appliance or any part thereof is proved to be defective by reason only of faulty workmanship or materials, we will, at our option, repair or replace the same **FREE OF CHARGE** for labour, materials or carriage on condition that:

- The appliance has been correctly installed and used only on the electricity supply stated on the rating plate
- The appliance has been used for normal domestic purposes only, and in accordance with the manufacturer's instructions
- The appliance has not been serviced, maintained, repaired, taken apart or tampered with by any person not authorised by us
- All service work under this guarantee must be undertaken by a Zanussi Service Force Centre
- Any appliance or defective part replaced shall become the Company's property
- This guarantee is in addition to your statutory and other legal rights

Home visits are made between **8:30 am and 5:30 pm** Monday to Friday. Visits may be available outside these hours in which case a **premium** will be charged.

## EXCLUSIONS

This guarantee does not cover:

- Damage or calls resulting from transportation, improper use or neglect, the replacement of any light bulbs or removable parts of glass or plastic

- Costs incurred for calls to put right an appliance which is improperly installed or calls to appliances outside the United Kingdom
- Appliances found to be in use within a commercial environment, plus those which are subject to rental agreements
- Products of Zanussi manufacture which are not marketed by Zanussi Limited

## EUROPEAN GUARANTEE

If you should move to another country within Europe then your guarantee moves with you to your new home subject to the following qualifications:

- The guarantee starts from the date you first purchased your product
- The guarantee is for the same period and to the same extent for labour and parts as exists in the new country of use for this brand or range of products
- This guarantee relates to you and cannot be transferred to another user
- Your new home is within the European Community (EC) or European Free Trade Area
- The product is installed and used in accordance with our instructions and is only used domestically, i.e. a normal household
- The product is installed taking into account regulations in your new country

Before you move please contact your nearest Customer Care centre, listed below, to give them details of your new home. They will then ensure that the local Service Organisation is aware of your move and able to look after you and your appliances.

France	Senlis	+33 (0) 3 44 62 29 99
Germany	Nurnberg	+49 (0) 911 323 2600
Italy	Pordenone	+39 (0) 1678 47053
Sweden	Stockholm	+46 (0) 8 738 79 50
UK	Newbury	+44 (0) 1635 521313

# Technical data

## Overall dimension (mm) :

Width	360
Depth	360
Height	247

## Cavity dimension (mm) :

Width	555
Depth	429
Height	348

## Volume :

32 litre

## Weight :

28 kg

**Build-In Kit : BF 450**

	<u>UK</u>	<u>AUS</u>	<u>NZ</u>
<b>Power source :</b>	240 V	240	230
	50 Hz	50 Hz	50 Hz
Circuit	13 A	10 A	10 A
<b>Power consumption (W) :</b>			
Microwave	1650	1650	1650
Grill	1550	1550	1400
Convection	1600	1600	1450
<b>Power output (W) :</b>			
Microwave	850	850	850
Grill	1500	1500	1500
Convection	1500	1500	1500