

RMD-1150 series

1U Rackmount display

Industrial PC chassis

User's manual

Copyright notice

This document is copyrighted, 2000, by Advantech Co., Ltd. All rights are reserved. Advantech Co., Ltd. reserves the right to make improvements to the products described in this manual at any time without notice.

No part of this manual may be reproduced, copied, translated or transmitted in any form or by any means without the prior written permission of Advantech Co., Ltd. Information provided in this manual is intended to be accurate and reliable. However, Advantech Co., Ltd. assumes no responsibility for its use, nor for any infringements upon the rights of third parties which may result from its use.

Acknowledgements

- AWARD is a trademark of AWARD Software, Inc.
- IBM and PC are trademarks of International Business Machines Corporation.
- Intel® and Pentium® III are trademarks of Intel Corporation.
- MS-DOS is a trademark of Microsoft Corporation.
- SMC is a trademark of Standard Microsystems Corporation.
- WinBond is a trademark of Winbond Corporation.
- Adaptec is a registered trademark of Adaptec, Inc.

All other product names or trademarks are the properties of their respective owners.

Part No. 2002000120
Printed in Taiwan

1st Edition
Mar.2001

A Message to the Customer

Advantech customer services

Each and every Advantech product is built to the most exacting specifications to ensure reliable performance in the harsh and demanding conditions typical of industrial environments. Whether your new Advantech equipment is destined for the laboratory or the factory floor, you can be assured that your product will provide the reliability and ease of operation for which the name Advantech has come to be known.

Your satisfaction is our primary concern. Here is a guide to Advantech's customer services. To ensure you get the full benefit of our services, please follow the instructions below carefully.

Technical support

We want you to get the maximum performance from your products. So if you run into technical difficulties, we are here to help. For the most frequently asked questions, you can easily find answers in your product documentation. These answers are normally a lot more detailed than the ones we can give over the phone.

So please consult this manual first. If you still cannot find the answer, gather all the information or questions that apply to your problem, and with the product close at hand, call your dealer. Our dealers are well trained and ready to give you the support you need to get the most from your Advantech products. In fact, most problems reported are minor and are able to be easily solved over the phone.

In addition, free technical support is available from Advantech engineers every business day. We are always ready to give advice on application requirements or specific information on the installation and operation of any of our products.

1.1 Safety Instructions, disclaimer, and warranty

Note: Read these instructions. Save these instructions for later use.

1. Follow all warnings and instructions marked on the product.
2. Unplug this product from the wall outlet before cleaning. Do not use liquid cleaners or aerosols cleaners. Use a damp cloth for cleaning.
3. Do not use this product near water.
4. Do not place this product on an unstable cart, stand, or table. The product may fall, causing serious damage to the product.
5. Slots and openings in the cabinet and the back or bottom are provided for ventilation; to ensure reliable operation of the product and to protect it from overheating, these openings must not be blocked or covered. The openings should never be placed near or over a radiator or heat register, or in a built-in installation unless proper ventilation is provided.
6. This product should be operated from the type of power indicated on the marking label. If you are unsure of the power available, consult your dealer or local power company.
7. This product is equipped with a 3-wire grounding type plug, a plug having a third (grounding) pin. This plug will only fit into a grounding-type power outlet. This is a safety feature. If you are unable to insert the plug into the outlet, contact your electrician to replace your obsolete outlet. Do not destroy the grounding-type plug.
8. Do not allow anything to rest on the power cord. Do not locate this product where persons will walk on the cord.
9. If an extension cord is used with this product, ensure that the total of the ampere ratings on the products plugged into the extension cord does not exceed the extension cord ampere

- rating. Also ensure that the total of all products plugged into the wall outlet does not exceed 15 amperes.
10. Never push objects of any kind into this product through cabinet slots as they may touch dangerous voltage points or short out parts that could result in a risk of fire or electric shock. Never spill liquid of any kind on the product.
 11. Do not attempt to service this product by yourself, as opening or removing covers may expose you to dangerous voltage points or other risks. Refer all servicing to service personnel.
 13. Unplug this product from the wall outlet and refer servicing to qualified service personnel under the following conditions:
 - a. When the power cord or plug is damaged or frayed.
 - b. If liquid has been spilled into the product.
 - c. If the product has been exposed to rain or water.
 - d. If the product does not operate normally when the operating instructions are followed. Adjust only those controls that are covered by the operating instructions since improper adjustment of other controls may result in damage and will often require extensive work by a qualified technician to restore the product to normal operation.
 - e. If the product has been dropped or the cabinet has been damaged.
 - f. If the product exhibits a distinct change in performance, indicating a need for service.
 14. If rack-mount equipment is used with this product, make sure to address the following :
 - (1) Elevated Operating Ambient Temperature--- If installed in a closed or multi-unit rack assembly ,the operating ambient temperature of the rack environment may be greater than room ambient. Therefore,consideration should be given to installing the equipment in an environment compatible with the manufacturer’s maximum rated ambient temperature

(2) Reduced Air Flow--- Installation of the equipment in a rack should be such that the amount of air flow required for safe operation of the equipment is not compromised.

(3) Mechanical Loading--- Mounting of the equipment in the rack should be such that a hazardous condition is not achieved due to uneven mechanical loading.

(4) Circuit overloading--- Consideration should be given to the connection of the equipment to the supply circuit and the effect that overloading of circuits might have on overcurrent protection and supply wiring. Appropriate consideration of equipment nameplate ratings should be used when addressing this concern.

(5) Reliable Grounding--- Reliable grounding of rack-mounted equipment should be maintained. Particular attention should be given to supply connections other than direct connections to the branch circuit.

1.2 Introduction

RMD switch family specifications:

Specifications	RMD-1150F-8	RMD-1150KM
User port number	2	1
Computer port number	8	1
Cascade control PC number	Up to 64	N/A
On-screen display (OSD)	Yes	Yes
Front panel button control	8	N/A
Hot plug-and-play	Yes	Yes
Hot-key control	Yes	N/A
Rack-mount kit	RMK08	N/A
Automatic scan interval	3, 8, 15, 30 seconds	N/A
Programmable scan pattern	Yes	N/A
Cable length (Max)	30 m (100ft) at CONSOLE. 30 m (100ft) at PC ports	
VGA	1600 x 1200, DDC2B	
KeyboardComputer mouse connectorMonitor	PS/2PS/2, serial (with adapter)HD-DB-15 male	
KeyboardConsole mouse connectorMonitor	PS/2PS/2HD-DB-15 female	
VGA Cable	4 cables 1.8 m 4 cables 1.0 m	1 cable 1.8 m
H x W x D (mm)(inch)size	44 x 436 x 180 mm (1.7 x 17.2 x 7.0 inches), 1 U height	44 x 436 x 180 mm (1.7 x 17.2 x 7.0 inches), 1 U height
Power supply (min)	12 V DC, 4 A	

Two-Console 15.0" TFT LCD display Switch

The advanced multi-access RMD switch and RMD-1150F-8 enables you to control multiple computers from one or two locations respectively. There is no interface card or software to configure. Installation is as easy as connecting cables between the RMD switch and your computers. Operation is as simple as entering a hot-key command and navigating through the user-friendly on-screen menu. RMD-1150F-8 switches 8 IBM-compatible computers and up to 64 IBM-compatible computers that are cascaded. The RMD switch is independent of the computer operating system.

On-Screen Display (OSD) Menu

The RMD switch with built-in OSD control, you can name your computers, switch to a computer from a list, configure settings with easy-to-use menus, view the name of the selected computer on-screen with a programmable time interval. The OSD displays the system status throughout this operation.

Automatic Mouse Conversion

The RMD switch allows you to connect computers with PS/2 or serial mouse ports (using adapters) and control the computers from internal mouse pad or one PS/2 mouse. The RMD switch automatically identifies the mouse and switches to proper mouse protocol.

High Video Quality

RMD-1150F-8 offers two consoles to display and control the computer that you connected. External console support provides VGA resolution up to 1600 x 1200 @ 85 Hz without any degradation and built-in console support 15.0" LCD display at 1024 x 768 @ 75Hz. Advanced VGA circuit design guarantees smooth, flicker-free switching from one computer to the other at distances up to 100 ft (30 m)* at both Console and PC sides.

* Tested with high-quality UL2919-rated, low-loss and shielded cables

1.2.1 Features

- Supports both PS/2 and serial mouse
- Cascade configuration expands system capability
- Auto-scan automatically selects computers sequentially
- Supports Microsoft IntelliMouse (Pro)
- Hot-key functions allow easy computer access
- Keyboard states automatically saved and restored when switching computers
- Operating system independent, transparent to all applications
- Plug and play system configuration
- Keyboard and mouse can be hot plugged at any time
- High VGA resolution 1600 x 1200 for external console
- DDC2B compatible
- Standard 19" rack mount design

1.2.2 Extra Features for On screen display for KVM switch

- Assign computers with unique and meaningful names
- Identify and select computers by the names
- Programmable scan filters unused computers
- Store system settings and name entries to non-volatile memory
- Password security locks computer from unauthorized access
- Gain complete control with easy-to-use OSD interface

1.2.3 More features for multi-access

- Manage multiple computers from two locations (RMD-1150F-8 only)
- Different console access, one by internal touch-pad, or external, may have different types of mouse i.e. generic PS/2 mouse and scroll mouse.
- Selectable User Timeout

1.3 Configurations

RMD-1150F-8 supports 8 computers. For applications with a large number of computers, RMD-1150F-8 can be cascaded to another model of RMD-1150F-8's family in a Master/slave configuration to support up to 64 computers.

Single RMD Switch Configuration

In case you need to use multi-access to manage your computer systems, connect a PS/2 keyboard, a PS/2 mouse and a VGA multi-sync monitor directly to the RMD-1150F-8's external CONSOLE port. Then, connect multiple sets of keyboard, mouse and monitor cables to the "PC x" ports of the RMD-1150F-8, as shown in figure 1.

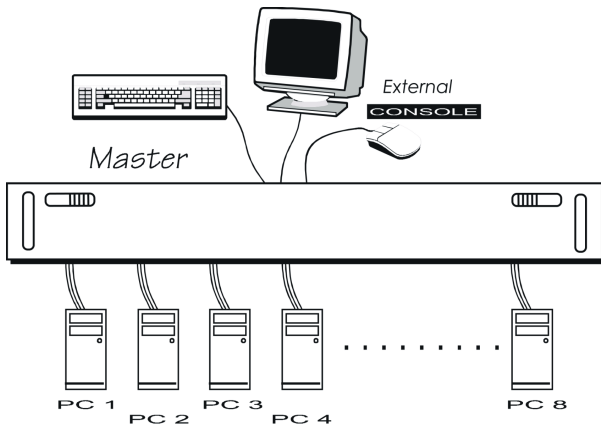

Figure 1-1: Single RMD-1150F-8 configuration

Note: Throughout this manual, RMD-1150F-8 is the Master that has a physical keyboard, mouse and monitor connected to its CONSOLE port. Slave is a RMD-1150F-8 KVM switch family that has its CONSOLE port connected to a RMD-1150F-8's "PC x" port. Slave only exists in cascade configuration.

1.4 Installation

External Device Connection

The monitor connected to the HD-DB-15 VGA port of a RMD switch CONSOLE must be capable of synchronizing with the computer's video signal. If you are uncertain about the monitor type, please consult the monitor user's manual. Connect a PS/2 mouse and a keyboard to the CONSOLE port marked with a mouse and a keyboard respectively as shown in figure 2.

NOTE: Only a PS/2 mouse can be connected to the CONSOLE mouse port. The RMD-1150F-8's automatic mouse conversion system allows you to connect computers using serial mouse and control the computers from one PS/2 mouse.

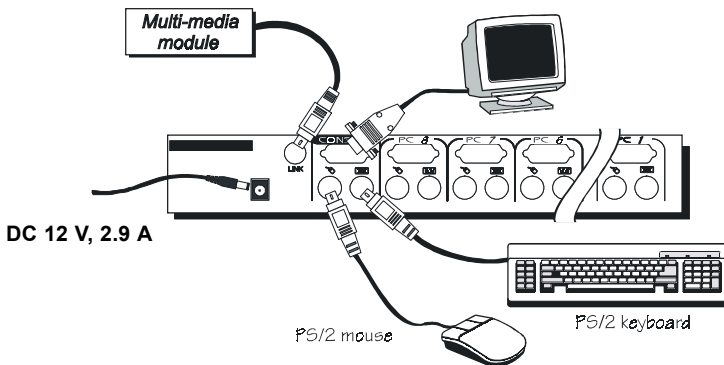

Figure1- 2: RMD-1150F-8 console connection

Determine the channel address of each computer. For computers using a PS/2 mouse, connect the computer's mouse and keyboard cables to the RMD-1150F8's connectors marked with a mouse and keyboard respectively, as shown in figure 3.

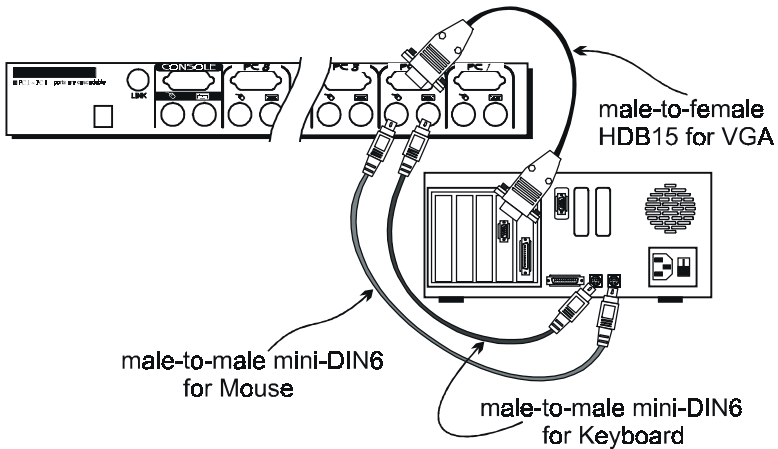

Figure 1- 3: RMD-1150F-8 computer connection

For computers using a serial mouse, connect the DB-9 to mini-DIN-6 adapter to the computer mouse port, then use PS/2 cables to connect the mouse to the RMD switch, see figure 4. Connect the computer's monitor cable to the HD-DB-15 VGA connector. Repeat above steps for all remaining computers to be connected to the RMD switch.

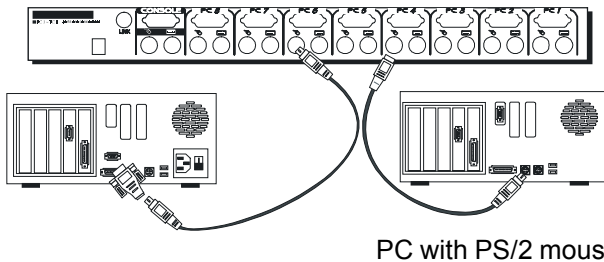

Figure 1-4: Adapter and serial mouse connection

Initial Power-Up

Make sure all computers and RMD switch are powered down during installation. You must power up the RMD switch before turning on any other devices.

- For single RMD switch:
 1. Apply a power adapter to the RMD switch.
 2. Turn on computers.
- For cascade:
 1. Apply a power adapter to the switch.
 2. Apply power adapters to all Slaves.
 3. Turn on computers.

Note: You may hot plug additional powered-down computer and Slave without turning existing RMD-1150F-8 or computer off after initial power up.

- Replace RMD-1150 External Console Devices

You can replace a faulty external keyboard or mouse of the RMD-1150 switch CONSOLE port at any time without powering down the RMD switch, as long as your computers are booted with proper device driver for the new device.

1.5 Operation (OSD (On-Screen-Display) Operation For KVM Switch)

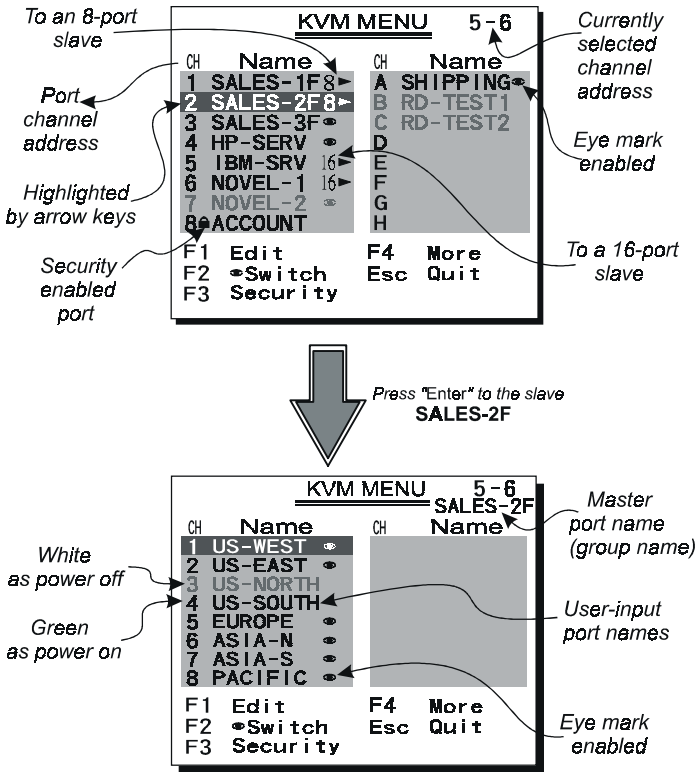

Figure 1-5: KVM portion OSD screen illustration

1.5.1 Introduction

By hitting the left <CTRL> key twice within two seconds, you may see the 'Hotkey Menu' if it is enabled (an OSD option). Or, by hitting the left <CTRL> key three times within two seconds, you

will see a 'KVM MENU' screen showing a list of the computers with corresponding channel addresses, names and status, see figure 5.

The channel address of the currently selected computer is displayed in red to the right of the OSD title 'KVM MENU'. The color of a device name is green if it has power and is ready for selection, or the color is white as it has no power. OSD menu updates the color when it is activated. Use the <UP> and <DOWN> arrow keys to highlight a computer and the <ENTER> key to select it. Or, you may press <ESCAPE> to exit OSD and remove the OSD menu from the display; the status window returns to the display and indicates the currently selected computer or operating status.

A triangle mark ► to the right of a name indicates the port is cascaded to a Slave; the number at the left of the triangle mark shows the number of ports the Slave has, i.e. 8► for KNV108. <ENTER> key brings you one level down and another screen pops up listing the names of the computers on that Slave. The name of the Slave will be shown at the upper right corner of the OSD menu. It is useful to group computers and still be able to see the group name.



An eye mark 👁 to the right of a name indicates the computer is selected to be monitored in Scan mode. In OSD, this mark can be switched on or off by function key <F2>.

Press <ESCAPE> key to exit OSD and to return to the selected computer; the computer name is also shown on the screen.

1.5.2 Function key <F1>

To edit name entry of a computer or a Slave. First, use the <UP> and <DOWN> arrow keys to highlight a channel then press <F1> followed by name entry. Valid characters are 'A'~'Z', '0'~'9' and the dash character. Lowercase letters are converted to uppercase ones. Press <BACKSPACE> to delete a letter one at a time. Non-volatile memory stores all name entries until you change, even if the unit is powered down.

1.5.3 Function key <F2>

To switch the eye mark  of a computer on or off. First, use the <UP> and <DOWN> arrow keys to highlight it, then press <F2> to switch its eye mark on or off. If Scan Type is 'Ready PC +' , only the power-on and eye mark selected computers will be displayed sequentially in Scan mode.

1.5.4 Function key <F3>

To lock a device (a computer or a Slave) from unauthorized access, use Security. Security is effective for only one device (a computer or a Slave). To lock a device, use the <UP> and <DOWN> arrow keys to highlight it, then press <F3>. Now, enter up to 4 characters ('A'~'Z', '0'~'9', '-') followed by <ENTER> as new password. A Security-enabled device is marked with a “lock symbol” following its channel number. To permanently disable the security function from a locked device, highlight it, press <F3> then enter the password.

If you want to access the locked device temporarily, simply highlight it and press <ENTER>, the OSD will ask you for the password. After entering correct password, you are allowed to use the device. This device is automatically re-locked once you switch to another one. During Scan mode, OSD skips the security-enabled device.

Note: Only one device (a computer or a Slave) can be locked by this function at a time.

Note!: If you forget the password, the only way to permanently disable the security function is to remove all possible power sources from the RMD-1150F-8. You will need to turn off all computers and unplug the RMD switch power adapters, then restart everything.

1.5.5 Function key <F4>

More functions are available by hitting <F4>. A new screen pops up displaying more functions as described below. Most of them are marked with a triangle (▶) indicating there are options to choose from. Using the <UP> and <DOWN> arrow keys, select the functions and press <ENTER>. Available options will be shown in the middle of the screen. Again, using the <UP> and <DOWN> arrow keys to view options then press <ENTER> to select it. You can press <ESCAPE> to exit at any time.

• **Auto Scan**

In this mode, the RMD-1150F-8 automatically switches from one power-on computer to the next sequentially in a fixed interval. During Auto Scan mode, the OSD displays the name of the selected computer. When Auto Scan detects any keyboard or mouse activity, it suspends the scanning till activity stops; it then resumes with the next computer in sequence. To abort the Auto Scan mode, press the left <CTRL> twice. Scan Type and Scan Rate set the scan pattern. Scan Type (<F4>:More\Scan Type) determines if scanned computers must also be eye mark selected. Scan Rate (<F4>:More\Scan Rate) sets the display interval when a computer is selected before selecting the next one.

• **Manual Scan**

Scan through power-on computers one by one by keyboard control. Scan Type (<F4>:More\Scan Type) determines if scanned computers must also be eye mark selected. Press the up arrow key (↑) to select the previous computer and the down arrow key (↓) to select the next computer. Press any other key to abort the Manual Scan mode.

• **Audio Stick**

An optional multimedia module can be linked to the back of each RMD switch for selecting microphone and stereo speaker signals. There are two options for Audio Stick: ON and Off. When set to 'On', audio selection follows computer selection. When set to 'Off', audio selection stops following computer selection.

It is useful if you want to listen to a particular computer's audio signal while operating other computers. The non-volatile memory stores the Audio Stick setting.

- **Scan Type**

Ready PC + : In Scan mode, scan through power-on and eye mark selected computers.

Ready PC: In Scan mode, scan through power-on computers. The non-volatile memory stores the Scan Type setting.

- **Scan Rate**

Sets the duration of a computer displayed in Auto Scan mode. The options are 3 seconds, 8 seconds, 15 seconds and 30 seconds. The non-volatile memory stores the Scan Rate setting.

- **Keyboard Speed**

RMD switch offers a keyboard typematic setting that overrides the similar settings in BIOS and in Windows. Available speed options are Low, Middle, Fast and Faster as 10, 15, 20 and 30 characters/sec respectively. The non-volatile memory stores the Keyboard Speed setting.

- **Hotkey Menu**

When you hit the left <CTRL> key twice within two seconds, the "Hotkey Menu" appears displaying a list of hot-key commands if the option is On. The 'Hotkey Menu' can be turned Off if you prefer not to see it when the left <CTRL> key is hit twice. The non-volatile memory stores the Hotkey Menu setting.

- **CH Display**

Auto Off: After you select a computer, the channel address and name of the computer will appear on the screen for 3 seconds then disappear automatically.

Always On: The channel address and name of a selected computer and/or OSD status displayed on the screen all the time. The non-volatile memory stores the CH Display setting.

• Position

The position of the selected computer name and/or OSD status displayed on screen during operation. The actual display position shifts due to different VGA resolution, the higher the resolution the higher the display position. The non-volatile memory stores the Position setting. UL as Upper Left, UR as Upper Right, LL as Lower Left, LR as Lower Right. MI as Middle.

1.5.6 ESC

To exit the OSD, press the <ESCAPE> key.

1.5.7 Hot-key commands

The Hot-key command is a short keyboard sequence to select a computer, to activate computer scan, etc. The RMD switch interprets keystrokes for hot-keys all the time. A hot-key sequence starts with two left <CTRL> keystrokes followed by one or two more keystrokes. A built-in buzzer generates a high-pitch beep for correct hot-key command; otherwise, one low-pitch beep for error and the bad key sequence will not be forwarded to the selected computer.

The short form hot-key menu can be turned on as an OSD function (<F4>:more\Hotkey Menu) every time the left <CTRL> key is pressed twice.

L-CTRL: is the <CTRL> key located at the left side of the keyboard.

1~8: are the number keys '1' ~ '8' at the upper row of the keyboard.

Note: Do not use the keypad at the right of the keyboard.

- To select a computer by hot-key command, you must know its channel address, which is determined by the RMD switch connection. For a computer connected to the RMD switch, its address is represented by the PC port label (1~8). For a computer connected to a Slave, two characters represent its address. The first character is the channel address of the RMD switch unit (1~8)

and the second one is the channel address of the Slave (1~8).

Left Ctrl + left Ctrl + 7

Selects a computer connected to port 7 of the RMD switch.

Left Ctrl + left Ctrl + 6 + C

Selects a computer connected to port C of a Slave connected to port 6 of the RMD switch.

- To start Auto Scan, automatically scan power-on computers one by one at a fixed interval:

left Ctrl + left Ctrl + F 1

When Auto Scan detects any keyboard or mouse activity, it suspends the scanning till activity stops; it then resumes with the next computer in sequence. The length of the Auto Scan interval (Scan Rate) is adjustable, see below. To abort the Auto Scan mode, press the left Ctrl key twice.

Note: Scan Type determines whether eye mark is necessary during Auto Scan.

- Manual Scan enables you to manually switch back and forth between power-on computers.

left Ctrl + left Ctrl + F2

Press ↑ or ↓ to select the previous or the next computer in sequence. And, press any other key to abort the Manual Scan.

Note: Scan Type determines whether eye mark is necessary during Manual Scan.

- To adjust Scan Rate which sets the duration before switching to the next computer in

Auto Scan:

left Ctrl + left Ctrl + F3

The RMD switch sends one to four beeps indicating scan intervals of 3, 8, 15 and 30 seconds respectively.

- To adjust keyboard typematic rate (characters/sec), this setting over-rides that of BIOS and any operating system:

left Ctrl + left Ctrl + F4

The RMD switch generates 1 to 4 beeps corresponding to 10, 15, 20 and 30 characters/sec respectively.

- Audio Stick

An optional multimedia module can be LINKed to the back of each RMD-1150F-8 for selecting microphone and stereo speaker signals. There are two options for Audio Stick:

ON and Off. When set to 'On', audio selection follows computer selection. When set to 'Off', audio selection stops following computer selection. It is useful if you want to listen to a particular computer's audio signal while operating other computers.

left Ctrl + left Ctrl + F5

The RMD-1150F-8 generates 1 or 2 beeps corresponding to On and Off respectively.

1.6 OSD (On-Screen-Display) Operation For LCD Monitor

The monitor control functions are located on the bottom side of the panel. They are shown in the figure below and described in the following paragraphs.

Key Definition

1. MENU:
Use the key to select the desired adjustment item .
2. ADJUST +/- SWITCH:
Use the key to change the value for optimal viewing.
3. POWER SWITCH:
Use the power switch to turn ON or OFF power. We recommend turning your system power on first, then the LCD monitor.

4. POWER STAND-BY MODE LED:

Show LCD system in the power stand-by model.

5. Power on LED:

Show LCD system in the power on model.

The Control Key Description

- 1. **MENU:** Press any key to MENU
- 2. **DOWN:** Move to the next item
- 3. **UP:** Move to the previous item
- 4. **+**: Increment control
- 5. **-**: Decrement control
- 6. **LCD POWER:** Power Switch
- 7. **-/+ SIMULTANEOUSLY:** Hot Key for Auto Adjusting

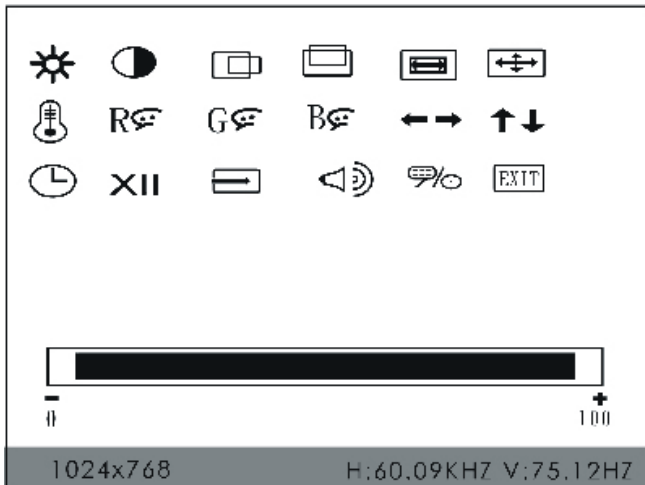

Figure 1-6: LCD monitor portion OSD screen illustration

**BRIGHTNESS:**

Adjust the backlight bulb intensity showing on the screen by pressing "+" or "-"

**CONTRAST:**

The operation is the same as the brightness by way of adjusting "+" or "-" to change the brightness value

**HORIZONTAL POSITION:**

Push to move the screen to the left or right

**VERTICAL POSITION:**

Push to move the screen up or down

**H-SCALING:**

Push to increase or decrease the Horizontal screen size (not available)

**AUTO ADJUSTMENT:**

Press "+" or "-" to move the AUTO adjustment, find the optimal.

**COLOR TEMPERATURE:**

Adjust "+" or "-" to get the best color optimization

- 9300K: Push to set monitor for the CIE coordinate 9300 color temperature
- 6500K: Push to set monitor for the CIE coordinate 6500 color temperature
- USER: Self defined color temperature(default)

**RED GAIN:**

Push to adjust "+" or "-" the screen red gain

**GREEN GAIN:**

Push to adjust "+" or "-" the screen green gain

**BLUE GAIN:**

Push to adjust "+" or "-" the screen blue gain

**OSD H POSITION:**

Press "+" or "-" to move the OSD location to left or right hand side.

**OSD V POSITION:**

Press "+" or "-" to move the OSD location to up or down.

**OSD TIMER:**

Press "+" or "-" to adjust the OSD Showing time.

XII**GAMMA ON/OFF:**

Press "+" or "-" to ON/OFF

**RECALL:**

Push adjust "+" or "-" to RECALL the default

**SPEAKER:**

Audio Volume(optional)

**CHANNEL SELECTION:**

Press to "+" or "-" select the VGA, S-Video and Video mode

EXIT**OSD EXIT: (for maintenance use)**

Press "+" or "-" to execute

1.7 Cascaded Configuration

1.7.1 General

Note: Before connecting a device (a computer or a Slave) to the RMD-1150F-8, you must turn off the device. The RMD-1150F-8 must also have equal or more 'PC x' ports than that of the Slave.

The ports labeled "PC 1"~"PC 8" can be connected to either a computer or a Slave's CONSOLE port, as shown in figure 8. A power adapter with DC 12V/3.5A output rating must be connected to the RMD-1150F-8, it supply either LCD display and switch to work.

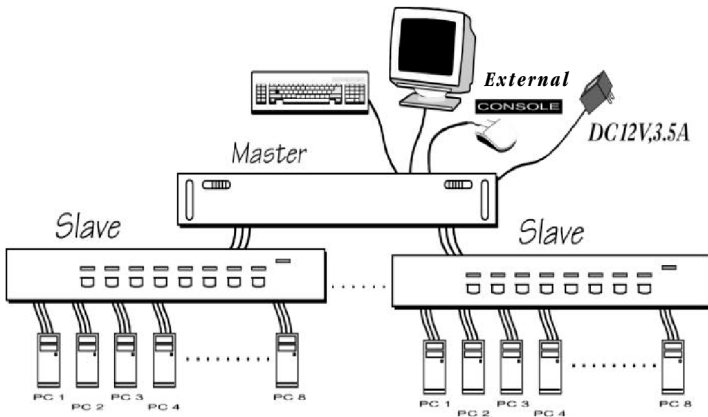

Figure 1-7: Cascaded 8-port RMD-1150F-8

- **For system check by OSD**

After connection completes, you should re-activate the KVM portion OSD menu to check if the RMD-1150F-8 recognizes the Slaves. A triangle mark (▶) is placed to the right of the channel name indicating the port is connected to a Slave not a computer. A number to the left of the triangle mark indicates the Slave model, i.e. 8▶ for KNV108 or KNV108D.

- **Change Configuration while Running**

Devices at any 'PC x' port can be changed at any time after initial power-up. If you change any one of the "PC 1" to "PC 8" ports connection from a computer to a Slave or vice versa, or replace the devices of a port; the OSD will update this change the next time it is activated.

Note: Any new device, a computer or a Slave, must be turned off before it is connected to the RMD-1150F-8.

1.7.2 Operation

On power up, the RMD-1150F-8 is in Idle mode broadcasting VGA signal from the selected computer and detecting for keyboard and mouse activity. No matter internal or external keyboard or mouse activity is detected, the RMD-1150F-8 immediately disables the other CONSOLE from accessing the computer. In the mean time, keyboard LEDs (Num/Caps/Scroll Lock) of the other CONSOLE start to flash as its access is denied and the monitor is blocked from VGA signal for security reason. After the user has finished his operation for a period of time (i.e., User Timeout), the multi-access RMD Switch returns to Idle mode. User Timeout has four options, 5 sec, 30 sec, 60 sec and HOLD. Select HOLD when you plan to access the RMD-1150F-8 for a long time. Pressing the <Scroll Lock> twice forces the RMD-1150F-8 return to Idle mode immediately regardless of the User Timeout setting.

The User Timeout is available in the OSD menu by pressing the Function key <F4>, under the sub-menu More.

Note: Keyboard Speed option is not available for multi-access models.

The LCD Products listed on this document are not suitable for use of aerospace equipment, submarine cables, nuclear reactor control system and life support systems. If customers intend to use these LCD products for above application or not listed in "Standard" as follows, please contact our sales people in advance.

Standard: Computer, Office equipment, Communication equipment, Test and Measurement equipment, Machine tool, Industrial robot, Audio and Visual equipment, Other consumer products.

Cleaning the Monitor

1. Make sure the monitor is turned off.
2. Never spray or pour any liquid directly onto the screen or case.
3. Wipe the screen with a clean, soft, lint-free cloth. This removes dust and other particles.
4. The display area is highly prone to scratching. Do not use ketene type material (ex. Acetone), Ethyl alcohol, toluene, ethyl acid or Methyl chloride to clear the panel. It might permanently damage the panel.
5. If still not clean, apply a small amount of non-ammonia, non-alcohol based glass cleaner onto a clean, soft, lint-free cloth, and wipe the screen
6. Don't let water or oil penetrate the monitor. If the droplets are kept for a long time, Staining and discoloration may occur.

Disclaimer

Advantech does not recommend the use of any ammonia or alcohol-based cleaners on the monitor screen or case. Some chemical cleaners have been reported to damage the screen and/or case of the monitor. Advantech will not be liable for damage resulting from use of any ammonia or alcohol-based cleaner.

1.8 Troubleshooting

Note: Ensure that all cables are well seated. Check that keyboard/mouse cables are not swapped. Label and bundle the cables for each computer to avoid confusion when connected to RMD-1150 switch.

Symtoms	Possible causes	Solutions
No OSD screen	-No power to RMD switch. -Loose monitor connection -Monitor not multi-sync	-Establish power by turning on computers, wait, press left CTRL keys several times. -Reconnect monitor. -Use multi-sync monitor
Horizontal blinking lines appears in LCD	-Incorrect resolution. -Incorrect V-Frequency	-Adjust to 1024x 768 resolution. -Adjust to different V-Frequency (Hz)
Keyboard error on boot	-Loose keyboard connection	.Make sure keyboard cables are Well seated
RMD switch slave does not work	.Improper installation procedures	-Make sure slave's CONSOLE is connected to RMD switch PC 1~ PC 8 port. -Remove any possible power supply to the slave (unplug all cables), before connecting it to the RMD-1150F-8
Keyboard strokes shifted	-The computer was in shifted state when last switched	-Press both SHIFT keys
The?and ? keys do not work in Manual Scan	-All PCs are off or only one PC is turned on. -Scan mode works for power-on computers only.Scan type is eye mark selected but no PC is eye mark selected in OSD.	-Turn computers on. -Press any other key to abort Manual Scan mode. -Set proper Scan type in OSD and determine which PCs are eye mark selected, do it in OSD.
Auto Scan does not switch PC and RMD switch beeps from time to time	-All PCs are off or only one PC is turned on. -Scan mode works for power-on computers only. -Scan type is eye mark selected but no power-up PC is eye mark selected in OSD.	-Turn on computer -Set proper Scan Type in OSD and determine which PCs are eye mark selected, do it in OSD. -Press left CTRL key twice to abort Auto Scan mode.

Symtoms	Possible causes	Solutions
Double OSD images at cascade configuration	.Improper slave connection procedure.	-Remove any possible power supply to the Slave (unplug all cables), before connecting it to the RMD switch.
OSD menu is not at the proper position	.OSD menu has fixed resolution and its size varies due to computer VGA resolution changes.	-Use <F4>.More\Position to select UL or UR. OSD menu may appear near the middle of the screen when LL or LR is selected.
Computer can not use serial mouse	.Loose mouse adapter.Incorrect mouse adapter	.Secure the mouse adapter to computer's COM port.Use only the mouse adapter comes with the unit
Can not select a computer connected to a slave	.Improper RMD switch unit connection.Improper slave unit connection.Too many levels of slaves	.Only RMD switch ports PC1~PC8 can be connected to slaves..Connect slave CONSOLE port to PC1~PC8 ports of the RMD switch..Only one level of slave units is allowed. Pop up OSD again to check if RMD-1150F-8 recognizes the slave connection. Look for triangle mark and the number before it.
The RMD switch fails to function occasionally.	.Computers do not supply enough power.	.Make sure a power adapter with minimum of 12 V 4 A output rating is firmly connected to the power jack.

Condition	Checkpoint
Picture doesn't appear.	<ul style="list-style-type: none"> -Check to make sure the signal cable is firmly seated in the socket -Check to see if the computer system Power is ON -Check that the brightness control is at the appropriate position, not at the minimum. -Turn off your monitor. Hold down + and - Simultaneously while turning on your monitor. This will reset your monitor and " all mode reset" Will appear.
Screen isn't synchronized.	<ul style="list-style-type: none"> -Check to make sure the signal cable is firmly seated in the socket. -Check that the output level matches the input level of your computer. -Make sure the signal timings of the computer system are within the specification of the monitor. -If your computer were working with a CRT monitor, you should check the current signal timing and shut down your computer before you connect the VGA Cable to this monitor.
Screen isn't centered.	Adjust the H-position, and V-position, or perform the Auto adjustment.
Screen is too bright (too dark).	Check if the brightness or contrast control is at the appropriate position, not at the Maximum (Minimum)
Screen shakes or waves.	<ul style="list-style-type: none"> -Moving all of objects which emit a magnetic field such as motor or transformer, away from the monitor. -Check if the specific voltage is applied. -Check if the signal timing of the computer system is within the specification of monitor.
If you can't troubleshoot using this chart, stop using your monitor and contact Advantech technical support.	

Compatible modes:

The display has been designed to be compatible with a variety of computers. The Table below describes the display timing of the compatible modes.

Input mode	Resolution	Zoom to 1024X768
XGA	1024X768	1:1
SVGA	800X600	HQ scale up
VGA	640X480	HQ scale up
DOS(TEXT)	640X400	Scale up
DOS(EGA)	640X350	Scale up
TEXT	720X400	Scale up
MAC	832X624	HQ scale up

Resolution Modes:

Mode	Resolution	H-Freq.(KHz)	V-Freq.(Hz)
Model 1	640x350	31.47	70
Model 2	640x400	24.82	56
Model 3	640x400	31.47	70
Model 4	640x480	31.47	60
Model 5	640x480	35	67
Model 6	640x480	37.86	72
Model 7	640x480	37.5	75
Model 8	640x480	43.27	85
Model 9	720x400	31.47	70
Model 10	720x400	37.92	85
Model 11	800x600	35.15	56
Model 12	800x600	37.87	60
Model 13	800x600	48.07	72
Model 14	800x600	46.87	75
Model 15	800x600	53.67	85
Model 16	832x624	49.71	74
Model 17	1024x768	35.52	43
Model 18	1024x768	48.36	60
Model 19	1024x768	56.47	70
Model 20	1024x768	57.52	72
Model 21	1024x768	60.02	65
Model 22	1024x768	68.67	85
Model 23	1024x768(MAC)	60.24	75

**You might not be able to run all of the modes due to the different brand of Panel. **

Limited Warranty

IN NO EVENT SHALL THE DIRECT VENDOR'S LIABILITY FOR DIRECT OR INDIRECT, SPECIAL, INCIDENTAL OR CONSEQUENTIAL DAMAGES, LOSS OF PROFIT, LOSS OF BUSINESS, OR FINANCIAL LOSS WHICH MAY BE CAUSED BY THE USE OF THE PRODUCT EXCEEDS THE PRICE PAID FOR THE PDOCUMENT.,

The direct vendor makes no warranty or representation, expressed or implied with respect to the contents or use of this documentation, and especially disclaims its quality, performance, merchantability, or fitness for any particular purpose.

The direct vendor also reserves the right to revise or update the product or documentation without obligation to notify any user of such revisions or updates. For further information, please contact your direct vendor.

All the brand names and registered trademarks are the property of their respective owners.

- TechNote -

Subject: Automatic serial mouse and PS/2 mouse conversion

Symptom: PS/2 mouse does not work at all.

Cause: As per IMB PC spec, there are two pins (# 2 and # 6) in PS/2 mouse connector left unconnected. These two pins are used for serial mouse identification and communication. However, very few motherboard designers ignore the spec and ground these pins. Therefore, when that computer boots up, the NovaView mistakenly identifies the mouse to be serial mouse.

Solution:

1. If you are using the 3-in-1 cables, just swap the keyboard cable with mouse cable. Why? There are 4 wires in the keyboard cable and 6 wires in the mouse cable. By swapping the cables, the two unused pins become not connected.
2. If you are not using the 3-in-1 cables, just use a 4-wire PS/2 cable to connect from the PC to the KVM switch. You may check if the cable has only 4 wires with a multimeter.
3. If that cable has 6 wires in it, you need some violence to solve this problem by pulling out those two EXTRA pins from the PS/2 mouse connector from that computer. Please refer to the diagram below, it is seen into the connector on the cable. You shall find 6 pins in it.

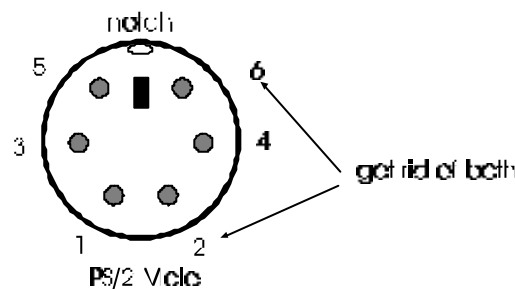

Note: I prefer solving such problem with some violence than any kind of design change. Much like kicking your car to get the engine starts.