

Technika

EXCLUSIVELY FROM TESCO

MC-109

Owner's Handbook

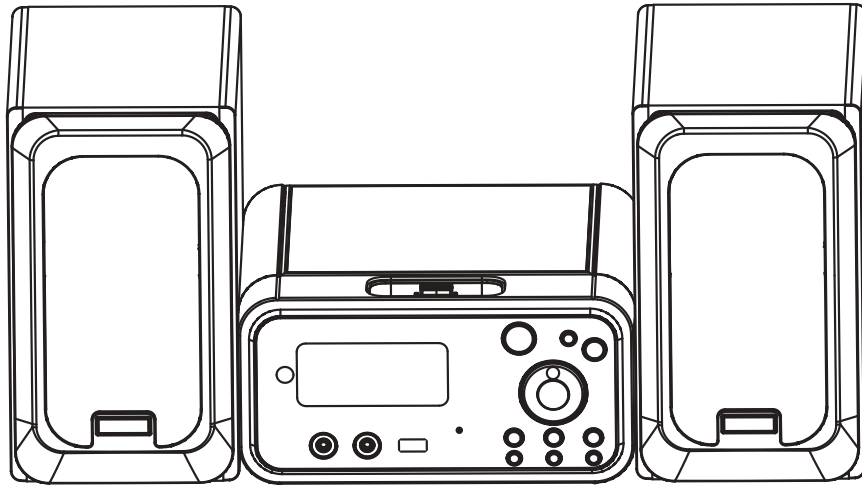

Mini DAB audio system with iPod dock



IMPORTANT SAFETY INFORMATION



This symbol indicates that there are important operating and maintenance instructions in the literature accompanying this unit.



This symbol indicates that dangerous voltage constituting a risk of electric shock is present within this unit.

Read these instructions.

Keep these instructions.

Heed all warnings.

Follow all instructions.

Do not use this apparatus near water.

Clean only with a slightly damp cloth.

Do not block any ventilation openings.

Install in accordance with the manufacturer's instructions.

Do not install or operate near any heat sources such as radiators, stoves, or other apparatus that produce heat.

Unplug this apparatus during lightning storms or when unused for long periods of time.

Refer all servicing to qualified service personnel. Servicing is required when the apparatus has been damaged in any way, such as the power-supply cord or plug is damaged, liquid has been spilled or objects have fallen into the apparatus, the

apparatus has been exposed to rain or moisture, does not operate normally, or has been dropped.

Warning: To reduce the risk of fire or electrical shock, do not expose this product to rain or moisture. The product must not be exposed to dripping and splashing and no object filled with liquids such as a vase of flowers should be placed on the product.

No naked flame sources such as candles should be placed on the product.

Caution: Changes or modifications not expressly approved by the manufacturer could void the user's authority to operate this device.

Caution: Usage of controls or adjustments or performance of procedures other than those specified herein may result in hazardous exposure.

IMPORTANT

This equipment generates, uses and can radiate radio frequency energy and, if not installed and used in accordance with the instructions, may cause harmful interference to radio communication. However, this is no guarantee that interference will not occur in a particular installation. If this equipment does cause harmful interference to radio or television reception, which can be determined by turning the equipment off and on, the user is encouraged to try to correct the interference by one of the following measures:

- Reorient or relocate the receiving antenna.
- Increase the separation between the equipment and receiver.
- Connect the equipment into an outlet on a circuit different from that to which the receiver is connected.
- Consult the dealer or an experienced radio/TV technician for help.

WARNING: DANGER OF RADIATION



These labels tell you that the unit contains a laser component. Opening the CD compartment lid and defeating the safety interlocks will expose the user to radiation from the laser beam. Do not stare into the laser while it is operating.

ELECTRICAL INFORMATION

Mains Supply: The mains operating voltage of this unit is marked on a rating plate on the underside of the unit.

The means of disconnecting this appliance from the mains supply is the mains plug. This should be unobstructed and readily operable at all times.

INDEX

INDEX

Introduction	2
Unpacking	2
Placement	3
Connecting speakers.....	3
Controls & connections	4
Connections.....	5
Remote control	6
Getting started	7
Setting the clock.....	7
Standby control, Volume.....	7
Listening to DAB radio	8
Listening to FM radio.....	8
DAB & FM Display modes.....	9
DAB Scanning, Advanced DAB operation	10
Listening to a CD.....	11
Listening to a MP3/WMA disc.....	12
Program play	13
iPod adaptors	14
Playing an iPod.....	15
Playing a personal audio player.....	15
Timer & Sleep functions.....	16
EQ & Bass boost	16
Headphones	17
System reset	17
Care & maintenance	17
Specifications	17

INTRODUCTION

Introduction

DAB (Digital Audio Broadcasting) technology allows many more radio stations compared to FM. DAB transmissions do away with problems of hiss and fade that plague AM and FM broadcasts and are less likely to be affected by adverse weather conditions or other sources of interference. In addition to speech and music DAB transmissions carry high levels of data - far greater than the limited RDS information available on FM stations.

Unlike FM, DAB is broadcast on many frequencies. Many countries in Europe, including the UK use Band III (174-230 MHz); others, France for example, use the L-Band (1452-1492 MHz). Germany uses both bands.

Your radio can tune Band III. Countries in Europe that use Band III include: Belgium, Denmark, Holland, Italy, Norway, Portugal, Spain, Sweden, Switzerland. Your radio will tune stations in all these countries.

Your radio cannot receive French or German stations broadcasting in the L-Band though FM services are available all over Europe.

Being digital, DAB transmissions can have a wider frequency range and greater dynamics than that available with FM technology.

FM reception is available on your system for use in those locations where there is no usable DAB service.

A headphone output is provided for personal listening.

PRELIMINARIES

UNPACKING

Carefully unpack the unit. If it is damaged, please return it to your nearest Tesco store for replacement. Remember to take your purchase receipt with you.

Retain the User Handbook. If you pass the unit on to a third party make sure you pass on the handbook.

We suggest you retain the packaging. If you dispose of it, do so having regard to any recycling regulations in your area.

CONTENTS

The carton should contain:

- The MC-109 audio system
- 2 x Loudspeakers
- Remote control with 2 x AAA batteries
- 8 x iPod dock adaptors
- Operating Manual

If any items are missing or damaged, contact your nearest TESCO store for a replacement. Have your receipt ready when you call. Retain the packaging. If you dispose of it, do so having regard to any recycling regulations in your area.

PREPARATION FOR USE

PLACEMENT

Place the unit on a sturdy table or shelf where it cannot get knocked over and where there is a clear line of sight to the remote handset.

Make sure that there is a clearance of 10cm (4 inches) around the unit for ventilation.

LOUDSPEAKERS

Placing the speakers

Unwrap the speaker wires from the ties securing them to the back of each speaker.

Place a speaker on either side of the main unit, preferably at the same height, and with at least 150mm between each speaker and the main unit.

Connecting the speakers

1. Locate the block of 4 speaker terminals on the back of the unit,
2. Lift the latches on the left channel speaker terminals as shown in the drawing.

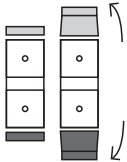

3. Feed the wires from the left speaker into the two terminals, observing the colour code with the black-striped wire connecting to the bottom black terminal.

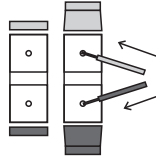

4. Press the latches down to lock the wires in place.

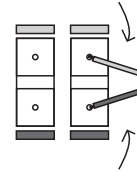

5. Repeat to connect the right speaker to the right channel speaker terminals.
6. Check that the bare ends of the wires are not exposed and cannot touch together.

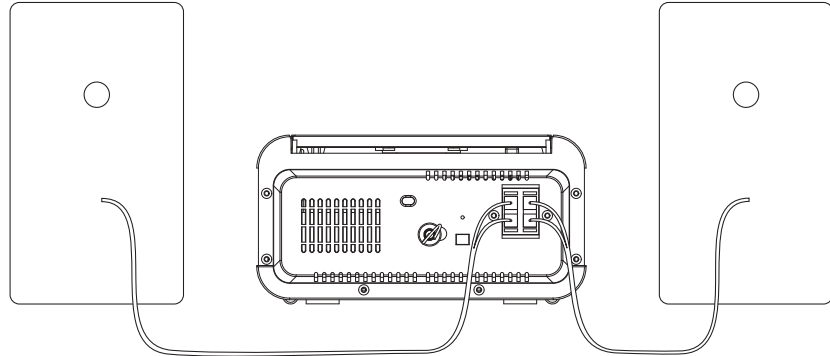

CONTROLS & CONNECTIONS

FRONT & TOP VIEW

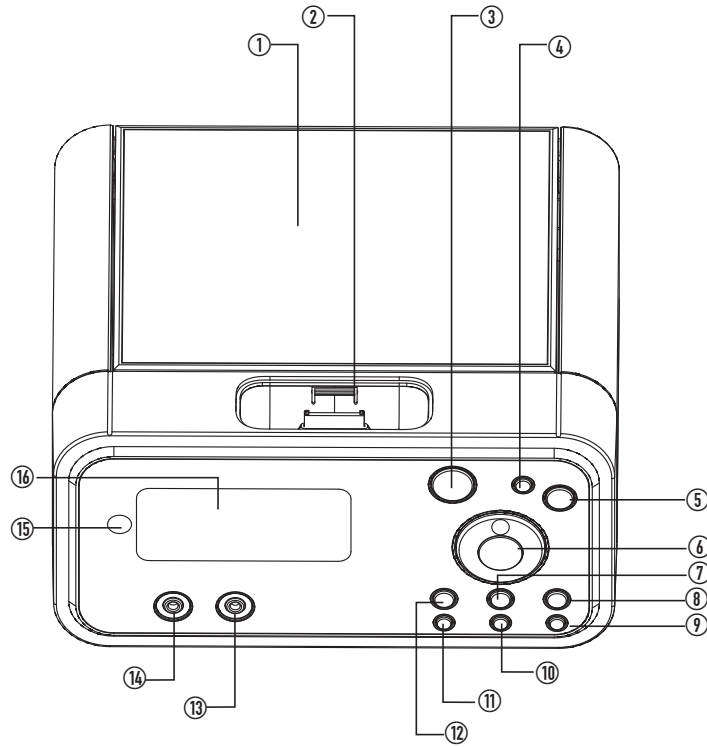

- ① CD compartment lid
- ② iPod dock
- ③ Standby button
- ④ Function button
- ⑤ Enter button
- ⑥ Volume control knob
- ⑦ Play/Pause Scan button
- ⑧ Info button
- ⑨ Memory/Clock button
- ⑩ Stop button
- ⑪ Previous button
- ⑫ Next button
- ⑬ Aux jack
- ⑭ Headphone jack
- ⑮ Remote sensor
- ⑯ Display window

CONNECTIONS

BACK VIEW

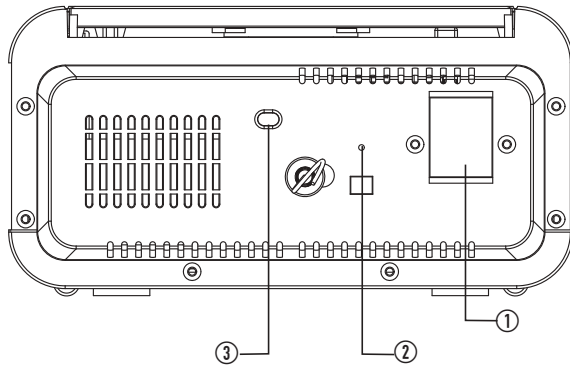

- ① Speaker terminals
- ② DAB/FM aerial
- ③ Power cord

DISPLAY FEATURES

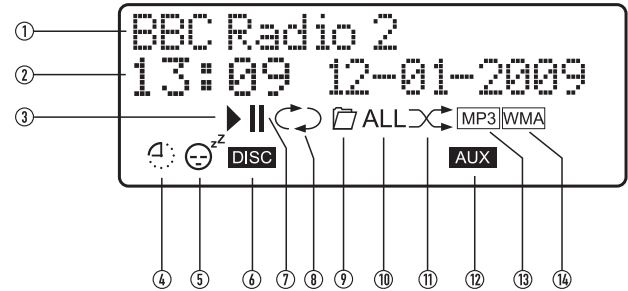

- ① Text display for tracks/stations
- ② Text display for information
- ③ Play symbol
- ④ Timer set symbol
- ⑤ Sleep symbol
- ⑥ Disc loaded symbol
- ⑦ Pause symbol
- ⑧ Repeat mode symbol
- ⑨ Repeat folder symbol
- ⑩ Repeat All symbol
- ⑪ Shuffle symbol
- ⑫ Aux mode symbol
- ⑬ MP3 disc symbol
- ⑭ WMA disc symbol

REMOTE CONTROL

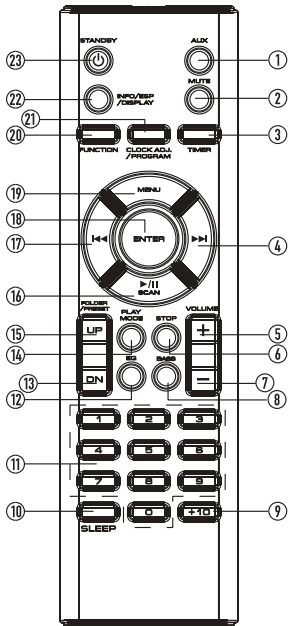

- ① AUX mode select button
- ② Mute button
- ③ Timer button
- ④ Next button
- ⑤ Volume up button
- ⑥ Stop button
- ⑦ Volume down button
- ⑧ Bass button
- ⑨ +10 button
- ⑩ Sleep button
- ⑪ Numeric keypad
- ⑫ EQ button
- ⑬ Folder scroll down button
- ⑭ Play mode button
- ⑮ Folder scroll up button
- ⑯ Play/Pause/Scan button
- ⑰ Previous button
- ⑱ Enter button
- ⑲ Menu button
- ⑳ Function button
- ㉑ Clock set/Program button
- ㉒ Info/ESP/Display button
- ㉓ Standby button

REMOTE CONTROL BATTERIES

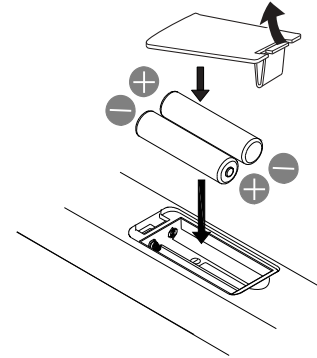

FITTING OR REPLACING THE REMOTE CONTROL BATTERIES

When replacing the batteries in the remote control, refer to the diagram above.

1. Press the catch on the battery door across.
2. While holding the catch, open the battery door.
3. Fit two AAA batteries observing polarity as shown. When replacing the batteries, use only the same AAA type specified.
4. Re-fit the battery door and clip it in place.

DISPOSAL OF BATTERIES

Dispose of used batteries with regard to the recycling regulations in your area. Do NOT short circuit batteries or throw them into water, the general rubbish or in a fire.

Weak batteries can leak and damage the remote control. Replace them in good time!

GETTING STARTED

REMOVING THE PACKING FROM THE CD PLAYER

Before connecting power to your audio system, the protective packing should be removed from the CD compartment.

To remove the protective packing:

- Open the CD compartment by pressing down on the **OPEN/CLOSE** area marked at the front corner of the CD lid.

The lid will open.

- Remove the cardboard protective packing from the CD compartment.
- Close the CD lid.

DAB/FM RADIO AERIAL

Before using your radio for DAB or FM reception, unwrap and fully extend the aerial wire. You may need to adjust the position of the aerial wire for maximum signal strength.

CONNECTING POWER

- Check that the mains voltage marked on the rating plate under the unit is the same as the voltage in your area.
- Plug the AC power cord into the AC inlet
- Plug the mains plug into the wall socket and switch the mains power on.

SETTING THE CLOCK

Automatic clock setting:

The clock time will set automatically when a DAB station is first tuned.

In areas where DAB reception is not available, manual clock setting will be necessary.

To set the clock manually:

- With the system set to Standby, press and hold the **MEMORY/CLOCK** button.

The display will show the legend '24 HOUR' with the digits 24 flashing.

NOTE: The display will not light during clock setting.

- Press the **◀◀** or **▶▶** buttons to select 24 hour or 12 hour mode for the clock.
- Press the **MEMORY/CLOCK** button.

The display will show the time currently set with the hours digits flashing.

- Press the **◀◀** or **▶▶** buttons to set the hours digits to the correct time.
- Press the **MEMORY/CLOCK** button.

The display will show the time currently set with the minutes digits flashing.

- Press the **◀◀** or **▶▶** buttons to set the minutes digits to the correct time.
- Press the **MEMORY/CLOCK** button.

The clock settings will be stored.

STANDBY CONTROL

STANDBY CONTROL

To turn the system on:

- Press the **STANDBY**  button on the front panel or remote control.

The display will light and the system will set to play the last function used. If this was radio, the last station played will be selected.

To turn the system off:

- Press the **STANDBY**  button.

The system and display light will switch off. The clock will continue to run whilst mains power is connected.

ADJUSTING THE VOLUME

VOLUME CONTROL

To increase the volume:

- Turn the **VOLUME** knob clockwise or press the **VOLUME +** button on the remote control.

To decrease the volume:

- Turn the **VOLUME** knob anti-clockwise or press the **VOLUME -** button on the remote control.

MUTE

You can use the Mute function to instantly set the volume to minimum.

To mute the volume:

- Press the **MUTE** button on the remote control to set mute at any time.
- Press the **MUTE** button again to restore the volume to its previous setting.

LISTENING TO DAB RADIO

SELECTING DAB RADIO OPERATION

To select DAB radio operation:

- Press the **FUNCTION** button repeatedly until 'DAB' is displayed.

After a few seconds, the radio will tune to the last-used station.

INITIAL DAB RADIO SCAN

When DAB radio is used for the first time:

The system scans all usable stations (full scan) and stores them alphanumerically -1 Radio, 2 Radio, AA Radio, AB Radio...

The initial scan will take a few minutes and a progress bar will be displayed with the number of services found.



Number of services found

After the scan, the clock will be set, the radio will display the first station in the sequence and begin playing at the default system volume of 13.

Note: If no stations are found after the scan, it may be that the signal in your current location is too weak. If this happens, switch the radio off and move it to a location with a stronger signal. Repeat the scan process in the new location.

The stations found will be stored in an alphanumeric list.

TO SELECT ANOTHER STATION

- Press the **◀◀** or **▶▶** button to browse the list of stations on the display.
- When you find the station name you want to listen to, press the **ENTER** button.

SIGNAL STRENGTH DISPLAY

You can display the signal strength of a DAB multiplex at any time whilst playing.

To switch the signal strength display on and off:

- Press the **ENTER** button.

The signal strength will be displayed as a bargraph. The signal strength display may be used when setting up the aerial position for maximum signal strength.

LISTENING TO FM RADIO

To change to the FM band

- Press the **FUNCTION** button on the front panel or remote control repeatedly until 'FM' is displayed.

To manually tune to FM stations

- Press the **◀◀** or **▶▶** button repeatedly to tune down or up the band one frequency step at a time.

To auto-tune to FM stations

- Press the **▶▶/SCAN** button to tune to the next station in the band.
- To change the sweep direction, press the **◀◀** button (to tune down) or **▶▶** button (to tune up) before pressing the **▶▶/SCAN** button.

Tuning will stop automatically when the station is reached.

STATION PRESETS

DAB and FM presets

Your radio can store up to 10 of your favourite stations as presets on both the DAB and FM bands for quick recall.

To store a preset

- Tune to the station you want to store as a preset.
- From the remote control, press and **hold** the **NUMBER (1-10+)** button for the preset location you want to store.

The display will confirm that the station has been stored in this preset number.

To recall a preset

- Press the **NUMBER (1-10+)** button briefly to recall a station stored in this preset number.

The radio will re-tune to the preset station number that you selected.

DAB & FM DISPLAY MODES

DAB DISPLAY MODES

When playing a DAB station you can change the information on the display by changing the display mode.

To change the display mode:

Press the **INFO** button repeatedly to cycle through the options listed in the chart below.

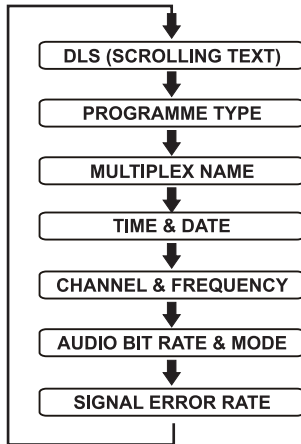

DLS (SCROLLING TEXT): This is a scrolling message giving real-time information - song titles, news headlines, etc.

PROGRAMME TYPE: This describes (when available) the style of the programme being broadcast.

MULTIPLEX NAME (GROUP NAME): is the name of the DAB Multiplex that is currently tuned.

TIME & DATE: Shows the current time and date. Time and date are updated by broadcasted information.

CHANNEL AND FREQUENCY: The Channel and Frequency display shows the multiplex channel number and the multiplex frequency for the station currently tuned.

BIT RATE: DAB allows broadcasters to vary the BIT RATE (or the amount by which an audio signal can be compressed) depending on the type of broadcast. This enables the amount of stations on a multiplex to be maximised. Speech and News are often broadcast at a lower Bit Rate; music needs a higher Bit Rate for good fidelity.

SIGNAL ERROR RATE: This Signal Error Rate is a measure of the signal quality. The lower the figure, the better the signal quality. The Signal Error Rate display is helpful when setting up the aerial wire. Move the wire to minimise the reading on your favourite stations.

FM DISPLAY MODES

Some FM stations broadcast additional 'RDS' station information. When RDS data is present on an FM transmission, 'RDS' will be displayed as shown below.

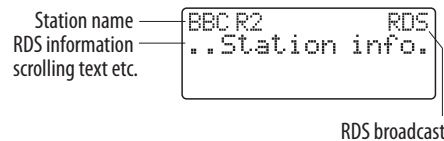

When playing an FM station you can change the information on the display by changing the display mode.

To change the display mode:

Press the **INFO** button repeatedly to cycle through the options listed in the chart below.

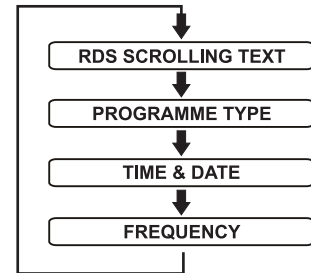

RDS (SCROLLING TEXT): This is a scrolling message giving real-time information - song titles, news headlines, etc.

PROGRAMME TYPE: This describes (when available) the style of the programme being broadcast.

TIME & DATE: Shows the current time and date. Time and date are updated by broadcasted information.

FREQUENCY: The Channel and Frequency display shows the multiplex channel number and the multiplex frequency for the station currently tuned.

DAB SCANNING

When first used, your audio system scanned the DAB band for available stations. The station services found were then stored in your system's memory.

You can re-scan the band at any time if you move to a different area or just to refresh the stored list of available stations.

Two types of scan are available, a Quick Scan that scans UK DAB bands for available services and a Full Scan, that scans all bands.

TO START A QUICK SCAN

- Select the DAB band.
- Press the **▶/SCAN** button **briefly** to start a quick scan or **hold** the button to start a full scan.

The unit will now display the legend 'SCANNING' and a bargraph to show scan progress. The number of services found during the scan will be shown at the right side of the display.

After running a Quick or Full scan the radio will re-tune to the last tuned station, or if this is not available, the first station found in alphabetical sequence.

DAB ADVANCED OPERATION

The DAB radio of your audio system includes several advanced features.

To select the advanced features:

- Press the **MENU** button on the remote control to open the advanced operation menu.
- To scroll through the menu options below, press the **◀◀** or **▶▶** button.

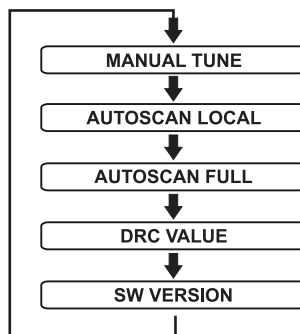

- To select a menu option, press the **ENTER** button.

MANUAL TUNE

Manual tuning may be used to tune the band by frequency or multiplex. A station multiplex may then be selected and displayed with a signal strength bargraph to assist with aligning the aerial for best signal.

To tune manually:

- Select Manual Tune from the menu.
- Press the **◀◀** or **▶▶** buttons to scroll through the multiplex numbers and frequencies.
- To select a multiplex, press the **ENTER** button.

The selected multiplex number will be displayed with (if present) the multiplex name and signal strength.

- Press the **◀◀** or **▶▶** button to re-tune to another multiplex.

AUTOSCAN LOCAL, AUTOSCAN FULL

You can start a local or full scan by selecting these menu options. This is an alternative method of starting a scan to that described in the SCANNING section on this page.

DRC VALUE

DRC is Dynamic Range Compression. Enabling DRC may improve the sound of DAB radio when listening in a noisy room. You can set the DRC value with this menu option.

- Select DRC from the menu.
- Press the **◀◀** or **▶▶** button to select the DRC value you prefer from the options of 0, 1/2 and 1.
- Press the **ENTER** button to confirm your selection.

SW VERSION

If you choose this option, the radio's software version is displayed. This is purely an aid for technicians should your radio ever need service.

LISTENING TO A CD

LOADING DISCS

To select CD/MP3/WMA disc operation:

- Press the **FUNCTION** button repeatedly until 'CD' is displayed.

Loading a disc:

- Press the **OPEN/CLOSE** area at the front corner of the disc lid on top of the unit.

The lid will open slowly.

- Gently place a disc on the centre spindle with the label side upward.
- Close the lid and press the **OPEN/CLOSE** area until it latches shut.

After a few seconds the disc will read and the disc data will be displayed.

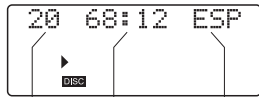

Total number
of tracks on
the CD

Total play
time

ESP Enabled

Unloading a disc:

- If the disc is playing, press the **STOP** button and wait a few seconds for the disc to stop.
- Press the **OPEN/CLOSE** area at the front corner of the CD lid.

The lid will open slowly.

Grip the disc at the sides and lift it out of the disc compartment.

CD PLAYBACK, PAUSE:

- Load the CD.
- Press the **▶||/SCAN** button to start the CD playing.
- When a CD is playing, pressing the **▶||/SCAN** button at any time will pause playback.

Selecting tracks:

- Press the **◀◀** or **▶▶** button **briefly** to select the previous or next track from the disc.

NOTE: The first press of the **◀◀** button will replay the current track.

Direct access track selection:

- Press a number button to select a track number.
- Press the **▶||/SCAN** button to skip to your chosen track.

Fast search:

- To fast search through a track, press and hold the **◀◀** or **▶▶** button.

The player will fast search through the track at high speed in the chosen direction until the button is released.

You can set repeat mode for CD or iPod listening.

REPEAT AND SHUFFLE FUNCTIONS

You can repeat a single track, the whole disc or select shuffle to play the tracks in a random sequence.

To set a repeat or shuffle mode:

- Press the **PLAY MODE** button on the remote control to cycle through the options of 'Repeat 1' (repeat current track), 'Repeat All' (Repeat the disc) or Shuffle (play tracks in a random sequence).

The Repeat, Repeat All or Shuffle symbol will be displayed.

ESP SYSTEM

The ESP system is an anti-shock feature for CD playback.

To toggle ESP on or off:

- Press the **INFO/ESP/DISPLAY** button when playing a CD.

The ESP legend will be displayed when ESP is switched on.

LISTENING TO A MP3/WMA DISC

MP3/WMA DISC PLAYBACK:

Your system can also play MP3 or WMA music compilations recorded onto a CD-R. The files may all be stored in the 'root' directory of the disc or organised in a set of sub-folders.

LOADING DISCS

To select CD/MP3/WMA disc operation:

- Press the **FUNCTION** button repeatedly until 'CD' is displayed.

Loading a disc:

- Press the **OPEN/CLOSE** area at the front corner of the disc lid on top of the unit.

The lid will open slowly.

- Gently place a disc on the centre spindle with the label side upward.
- Close the lid and press the **OPEN/CLOSE** area until it latches shut.

After a few seconds the disc will read and the disc data will be displayed.

Unloading a disc:

- If the disc is playing, press the **STOP/■** button and wait a few seconds for the disc to stop.
- Press the **OPEN/CLOSE** area at the front corner of the CD lid.

The lid will open slowly.

Grip the disc at the sides and lift it out of the disc compartment.

MP3/WMA DISC PLAYBACK, PAUSE:

- Load the MP3/WMA disc.

The number of tracks on the disc (and folders if applicable) will be displayed.

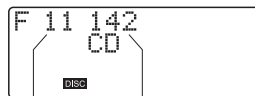

- Press the **▶||/SCAN** button to start the disc playing.
- When a disc is playing, pressing the **▶||/SCAN** button at any time will pause the CD.

Selecting tracks:

- Press the **◀◀** or **▶▶** button **briefly** to select the previous or next track from the disc.

NOTE: The first press of the **◀◀** button will replay the current track.

Fast search:

- To fast search through a track, press and hold the **◀◀** or **▶▶** button.

The player will fast search through the track at high speed in the chosen direction until the button is released.

If the music files on the disc are organised into folders you can change between folders.

To change folders (if there are more than 1):

- Press the **FOLDER/PRESET UP** or **DN** button on the remote control to scroll through the folders on the disc.

- You can then change search for tracks within the folder using the **◀◀** or **▶▶** button.

Direct access track and folder selection:

- Press a number button to select a track number.
- Press the **▶||/SCAN** button to skip to your chosen track.

REPEAT AND SHUFFLE FUNCTIONS

You can repeat a single track, the current folder, the whole disc or select shuffle to play the tracks in a random sequence.

To set a repeat or shuffle mode:

- Press the **PLAY MODE** button on the remote control to cycle through the options of 'Repeat 1' (repeat current track), 'Repeat Folder' (Repeat all tracks in the current folder), 'Repeat All' (Repeat the disc) or Shuffle (play tracks in a random sequence).

The Repeat, Repeat Folder, Repeat All or Shuffle symbol will be displayed.

PROGRAM PLAY FROM A CD OR MP3/WMA DISC

CD & MP3/WMA DISC PROGRAMMING

When playing a CD or MP3/WMA compilation disc, you can store a random sequence of up to 64 tracks to play in your preferred order.

STORING A CD PROGRAM

To store a CD program:

- Load the disc you want to play, wait for the disc to read.
- Press the **MEMORY/CLOCK** button on the front panel or the **CLOCK ADJ./PROGRAM** button on the remote control.

The Program Entry display will appear, prompting for the first track number to program (P-01).

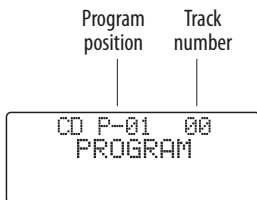

- Press the **◀◀** or **▶▶** button to select the track number for the first track you want to program.
- Press the **MEMORY/CLOCK** button on the front panel or the **CLOCK ADJ./PROGRAM** button on the remote control to store this track into the program memory.

The track will be stored and the program counter will increase to P-02.

- Repeat the above two steps to store the next and subsequent tracks in your program sequence.

Playing the program

- When you have finished entering all tracks in your program, press the **▶||/SCAN** button to start the program playing.

Navigating the programmed tracks:

When the program is playing, the play and pause buttons work as normal and you can skip between tracks in the program by pressing the **◀◀** or **▶▶** buttons.

STORING A MP3/WMA PROGRAM

Some MP3/WMA compilation discs will be arranged with all tracks in the 'root' folder of the disc, others will be arranged within a set of folders. The same sequence is used for both types of disc.

To store a MP3/WMA program:

- Load the disc you want to play, and wait for the disc to read.
- Press the **MEMORY/CLOCK** button on the front panel or the **CLOCK ADJ./PROGRAM** button on the remote control.

The Program Entry display will appear, prompting for the first folder and track number to program (P-01).

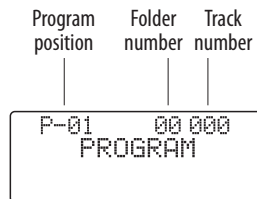

- Press the **◀◀** or **▶▶** button to select the folder number for the first track you want to program.

NOTE: If all tracks are arranged in the 'root' directory of the disc, only 'Folder 1' (F 01) will be selectable at this stage.

- Press the **MEMORY/CLOCK** button on the front panel or the **CLOCK ADJ./PROGRAM** button on the remote control to select this folder.
- Press the **◀◀** or **▶▶** button to select the track number within this folder for the first track you want to program.
- Press the **MEMORY/CLOCK** button on the front panel or the **CLOCK ADJ./PROGRAM** button on the remote control to store this track into the program memory.

The track will be stored and the program counter will increase to P-02.

- Repeat the previous four steps to store the next and subsequent tracks in your program sequence.

Playing the program

- When you have finished entering all tracks in your program, press the **▶||/SCAN** button to start the program playing.

Navigating the programmed tracks:

When the program is playing, the play and pause buttons work as normal and you can skip between tracks in the program by pressing the **◀◀** or **▶▶** buttons.

iPod ADAPTORS

Before docking your iPod you must first check if your iPod has a docking connector. Early iPod models do not have one and cannot be docked to your unit. The docking connector is located on the base of the iPod as shown below.

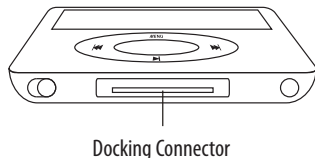

Before docking your iPod, you must fit the correct iPod adaptor to the docking bay. Each iPod adaptor matches the shape of a particular iPod and is necessary to ensure that your iPod is securely held when docked.

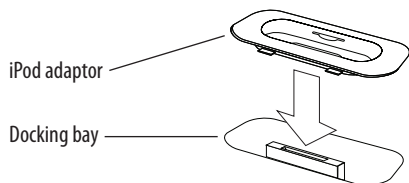

FINDING THE CORRECT iPod ADAPTOR

Your iPod docking system is supplied with a selection of docking adaptors that are compatible with several models in the iPod range. Each adaptor is marked with compatible model(s).

Refer to the table of iPod models in the next column which lists the supplied adaptors, and instructions for obtaining an adaptor for unlisted models.

NOTE: Do not dock an iPod without fitting the correct adaptor, you may damage the iPod and your unit.

SELECTING AN ADAPTOR

LIST OF SUPPLIED ADAPTORS

- iPod nano (first or second generation)
- iPod mini (4GB or 6GB)
- iPod photo, with a colour display (40GB or 60GB)
- iPod video (30GB, 60GB or 80GB)
- iPod Classic (80GB or 160GB)
- iPod photo, with a colour display (20GB or 30GB)
- iPod, with a B&W display and clickwheel with legends on wheel (20GB)
- iPod, with a B&W display and clickwheel with legends on wheel (40GB)

Other iPod models with dock connectors

Your iPod may have been supplied, packed with a standard dock adaptor. If so, this can be used as the docking bay on your unit is compatible with adaptors supplied by Apple.

If you don't have a dock adaptor

If your iPod was not supplied with a standard dock adaptor, you can buy one from Apple on-line. To determine the exact model of your iPod, refer to this web-link - <http://support.apple.com/kb/HT1353>. You can then browse the iPod accessories page on the Apple website to find an adaptor for your iPod model that can be purchased on-line.

Once you have located the correct adaptor for your iPod, press it gently into the iPod Docking Bay before attempting to dock your iPod.

CONNECTING OTHER iPod MODELS (INC SHUFFLE)

To connect your iPod via the AUX jack:

- Using a 3.5mm stereo jack cable (not supplied), connect one end of the cable to the headphone socket of the iPod, and the other end to the AUX jack on the front panel.

Headphone jack

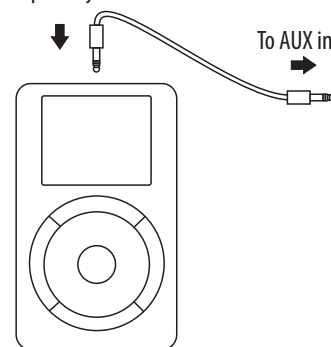

- To listen to your iPod, follow the instructions on page 15 for playing equipment connected to the AUX jack.

NOTE:- The volume control of the iPod must be turned up when playing through the AUX jack.

NOTE:- An iPod connected to the AUX jack cannot be operated from the remote control.

DOCKING AN iPod

DOCKING YOUR iPod

To dock your iPod:

- Check that the correct iPod adaptor is fitted to the docking bay.
- Locate the iPod on the Docking Connector and press it gently home.

To remove your iPod from the dock:

- Grip the iPod at the sides.
- Lift the iPod gently from the dock.

CHARGING AN iPod

When an iPod is docked and the unit is switched on, the iPod will begin to charge automatically.

NOTE:- The iPod will stop charging if the unit is set to Standby.

PLAYING FROM AN iPod

To play music from your iPod

- Press the **FUNCTION** button repeatedly until 'iPod' is displayed.

You can now operate your iPod functions from the controls on the remote control.

Playback functions:

- Press the **▶/SCAN** button to toggle the iPod between Play and Pause mode at any time.
- Press the **◀◀** or **▶▶** button on the front panel or remote control to select the previous or next track, photo or video.

iPod menu functions:

You can press the **MENU, OK** and **FOLDER/PRESET UP** or **DN** buttons on the remote control to navigate the iPod menus.

- To move up through the iPod menus, press **MENU**.
- To scroll up and down menu items, press the **FOLDER/PRESET UP** or **DN** buttons.
- To select menu items, press the **OK** button.

From the iPod menu you can select from Music, Photo or Video playback, then select from tracks, playlists, pictures and movies that are stored on your iPod.

iPod repeat modes:

Press the **PLAY MODE** button on the remote control repeatedly to cycle through 'Repeat 1', 'Repeat All' or 'Repeat Off' modes on the iPod (the mode set will display on the iPod screen).

PLAYING VIA THE AUX JACK

To play music from an iPod or Personal Audio player connected to the AUX jack -

- Press the **FUNCTION** button repeatedly until 'AUX' is displayed.
- Set the iPod or Personal Audio player to play.
- Turn the volume level on your Personal Audio player up to about half level.
- Set the volume on your audio system to the level you require. If the volume will not set high enough you may need to increase the volume setting on the player.

NOTE:- It is not possible to navigate the menu system of an iPod or other personal audio player with the remote control of the audio system if it is connected via the AUX jack.

SETTING THE TIMER

Your system includes a timer that enables you to set times for the system to switch on and switch off automatically.

To set the timer:

- Press the **TIMER** button on the remote control to step through each stage in timer setting, shown in the sequence below.
- To make changes to a setting, press the **◀◀** or **▶▶** button.
- Press the **TIMER** button to confirm each setting and move on to set the next.

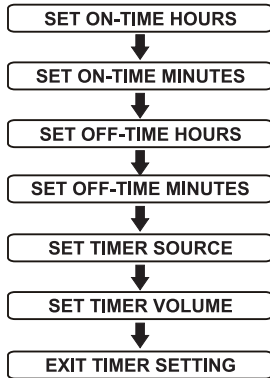

When timer setting is complete, the timer can be switched on or off by pressing the **TIMER** button.

The Timer symbol shows on the display when the timer is activated.

SLEEP MODE

THE SLEEP FUNCTION

The Sleep function allows you to program your system to switch itself off after a set period in 10 minute steps from 90 minutes down to 10 minutes.

To activate the Sleep function:

- Press the **SLEEP** button.
- The display will show Sleep 90.*
- Now press the **SLEEP** button repeatedly until your required sleep time appears on the display.

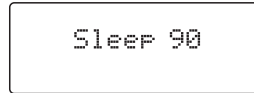

When sleep mode is set, the sleep symbol will appear on the display to confirm that sleep mode is set.

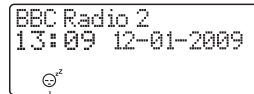

Sleep symbol

Your system will continue to play, then will set to Standby when the sleep time expires.

To check the Sleep time remaining:

- Press the **SLEEP** button during Sleep mode.
- The Sleep time remaining will be shown on the display.

EQ & BASS BOOST

You can change the equalisation of the sound or boost the level of bass to suit your taste.

To select an EQ response:

- Press the **EQ** button on the remote control repeatedly to cycle through the EQ options optimised as shown below.

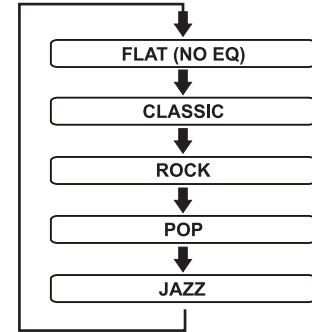

As each setting is selected, the sound EQ will change.

To select bass boost:

- Press the **BASS** button on the remote control to toggle bass boost on or off.

HEADPHONES

There is a headphone output socket on the front panel of the unit. If headphones are connected to this socket for private listening, the speakers will cut out automatically.

SYSTEM RESET

DAB is a terrestrial system and frequencies in different areas vary. If you move the radio to another part of the country performing a Full Scan may not be enough to re program the radio you may need to reset the radio.

To restore the factory settings:

- Set the system to DAB mode.
- Press and **hold** the **MEMORY/CLOCK** button on the front panel until the display flashes 'Factory Reset'.
- Press the **▶/SCAN** button to confirm factory reset.

The unit will now scan for DAB broadcast stations in your area.

After reset the settings are returned to the factory defaults and all the presets are erased.

CARE AND MAINTENANCE

AFTER USING YOUR SYSTEM

- Set to Standby.
- Switch the unit off at the mains and unplug it if you are leaving it unattended for a long period (holidays etc).

CARE AND CLEANING

All care and cleaning operations should be carried out with the unit unplugged from the mains power.

Occasionally wipe the cabinet with a lint free duster. Never clean the unit with liquids or solvents.

Loudspeaker grilles can be cleaned carefully with a soft brush.

SPECIFICATIONS

SPECIFICATIONS

Supply Voltage :230 V~, 50Hz

Power Consumption25 W

Net Weight:4.36 kg



Class II construction double insulated.

This product must not be connected to earth.

WARRANTY

Your Tesco appliance is covered by a warranty for 12 months from the date of purchase. If a fault develops during this period, please contact the TESCO electrical help line on 0845 456 6767. Please have your original purchase receipt with you when you call. This warranty in no way affects your consumer rights.



UK: Waste electrical products /batteries should not be disposed of with household waste. Separate disposal facilities exist, for your nearest facilities. See www.recycle-more.co.uk or in-store for details.

ROI: Produced after 13th August 2005. Waste electrical products/batteries should not be disposed of with household waste. Please recycle where facilities exist. Check with your Local Authority or retailer for recycling advice.

Technika

Tesco Stores Ltd,
Delamare Road, Cheshunt, Herts, EN8 9SL

▲ **Technika Helpline: 0845 456 6767** (Calls cost up to 4p per minute from a BT landline, other providers may vary)

MC-109 V0.2