



# Power Pruner™ Attachment

## *Operator's Manual*

**MODEL            99944200530**

**FOR MODELS    SRM-2100SB/2400SB  
                     SRM-210SB/211SB  
                     SRM-260SB/261SB  
                     PAS 2100/2400  
                     PAS 210/211  
                     PAS 230/231  
                     PAS 260/261**

**ENGLISH**

**ESPAÑOL**

**FRANCAIS**



### **WARNING**

Read rules for safe operation and instructions carefully. ECHO provides an Operator's Manual and a Safety Manual for Pro Attachment Series power source or Split Boom Trimmer. Those manuals and this manual must be read and understood for proper and safe operation, otherwise serious personal injury may result.

## INTRODUCTION

Welcome to the ECHO family. This ECHO product was designed and manufactured to provide long life and on-the-job-dependability. Read and understand this manual and the SAFETY MANUAL you found in the same package. You will find both easy to use and full of helpful operating tips and SAFETY messages.

## THE OPERATOR'S MANUAL

Read and understand this manual before operation. Keep it in a safe place for future reference. It contains specifications and information for operation, starting, stopping, maintenance, storage and assembly specific to this product.

## THE ATTACHMENT OPERATOR'S MANUAL

Read and understand this manual before operation. Keep it in a safe place for future reference. It contains specifications and information for operation and maintenance specific to the attachment.

## THE SAFETY MANUAL

*(If available for attachment)*

Explains possible hazards and what measures you should take to insure safe operation.

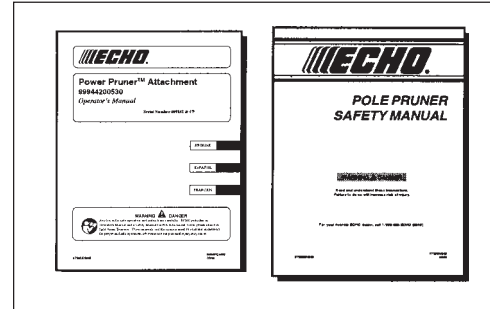

## TABLE OF CONTENTS

Introduction .....	2	Maintenance .....	12
- The Operator's Manual .....	2	- Skill Levels .....	12
- The Safety Manual .....	2	- Maintenance Intervals .....	12
Safety .....	3	- Lubrication .....	12
- Manual Safety Symbols and Important Information .....	3	- Guide Bar and Saw Chain Replacement .....	13
- International Symbols .....	3	- Filing Saw Chain .....	15
- Personal Condition and Safety Equipment .....	4	Storage .....	17
- Kickback .....	6	Specifications .....	17
- Equipment .....	7	Servicing Information .....	20
Description .....	7	- Parts/Serial Number .....	20
Contents .....	8	- Service .....	20
Assembly .....	8	- ECHO Consumer Product Support .....	20
- Power Head Shaft/Lower Shaft Assembly .....	8	- Warranty Card .....	20
- Front Handle Removal .....	9	- Manual Ordering Instructions .....	20
- Saw Chain Tension Adjustment .....	9		
Operation .....	10		
- Lubricating the Guide Bar and Saw Chain .....	10		
- Adjusting Automative Oiler .....	10		
- Pruning Techniques .....	11		

Specifications, descriptions and illustrative material in this literature are as accurate as known at the time of publication, but are subject to change without notice. Illustrations may include optional equipment and accessories, and may not include all standard equipment.

## SAFETY

### MANUAL SAFETY SYMBOLS AND IMPORTANT INFORMATION

Throughout this manual and on the product itself, you will find safety alerts and helpful, informational messages preceded by symbols or key words. The following is an explanation of those symbols and key words and what they mean to you.

 **DANGER**  
The safety alert symbol accompanied by the word “DANGER” calls attention to an act or condition which **WILL** lead to serious personal injury or death if not avoided.

 **WARNING**  
The safety alert symbol accompanied by the word “WARNING” calls attention to an act or condition which **CAN** lead to serious personal injury or death if not avoided.













 **CAUTION**  
The safety alert symbol accompanied by the word “CAUTION” calls attention to an act or condition which may lead to minor or moderate personal injury if not avoided.











 **CIRCLE AND SLASH SYMBOL**  
This symbol means the specific action shown is prohibited. Ignoring these prohibitions can result in serious or fatal injury.

**NOTE**  
This enclosed message provides tips for use, care and maintenance of the unit.

**IMPORTANT**  
The enclosed message provides information necessary for the protection of the unit.

### INTERNATIONAL SYMBOLS

Symbol form/shape	Symbol description/application	Symbol form/shape	Symbol description/application
	Read and understand Operator's Manual.		Fuel and oil mixture
	Wear eyes, ears and head protection		Finger Severing
	Hot Surface		Wear hand protection. Use two handed.
	Safety/Alert		DO NOT smoke near fuel.
	Avoid all power lines. This unit is not insulated against electrical current.		Do not operate closer than 15 M (50 ft.) from electrical hazards.
	Keep bystanders at least 15 meters (50 feet) away.		Plan retreat path from falling objects.

Symbol form/shape	Symbol description/application	Symbol form/shape	Symbol description/application
	DO NOT allow flames or sparks near fuel.		Wear slip resistant foot wear.
	Engine choke control.		Ignition ON/OFF
	Emergency stop		Primer bulb
	Chain lubrication		Carburetor adjustment - High speed mixture
	Carburetor adjustment - Low speed mixture		Carburetor adjustment - Idle speed

## PERSONAL CONDITION AND SAFETY EQUIPMENT



### WARNING

Power Pruner™ Attachment users risk injury to themselves and others if the Power Pruner™ Attachment is used improperly and or safety precautions are not followed. Proper clothing and safety gear must be worn when operating a Power Pruner™.

### *Physical Condition*

Your judgment and physical dexterity may not be good:

- if you are tired or sick,
- if you are taking medication,
- if you have taken alcohol or drugs.

Operate unit only if you are physically and mentally well.

### *Eye Protection*

Wear eye protection that meets ANSI Z87.1 or CE requirements whenever you operate the unit

### *Face and Head Protection*

When trimming overhead, always wear head protection meeting ANSI Z89.1 or CE requirements with a full face shield. Head protection with full face shield will help protect you from falling branches and debris.

### *Hand Protection*

Wear no-slip, heavy duty work gloves to improve your grip on the unit handles. Gloves also reduce the transmission of machine vibration to your hands.

### *Vibration and Cold --*

It is believed that a condition called Raynaud's Phenomenon, which affects the fingers of certain individuals may be brought about by exposure to vibration and cold. Exposure to vibration and cold may cause tingling and burning sensations followed by loss of color and numbness in the fingers. The following precautions are strongly recommended because the minimum exposure which might trigger the ailment is unknown.

- Keep your body warm, especially the head, neck, feet, ankles, hands and wrists.
- Maintain good blood circulation by performing vigorous arm exercises during frequent work breaks and also by not smoking.
- Limit the hours of operation. Try to fill each day with jobs where operating the trimmer or other hand-held power equipment is not required.
- If you experience discomfort, redness and swelling of the fingers followed by whitening and loss of feeling, consult your physician before further exposing yourself to cold and vibration.

### *Hearing Protection*

ECHO recommends wearing hearing protection whenever unit is used.

### *Proper Clothing*

Wear snug fitting, durable protective clothing; chain saw safety pants or chaps are recommended.

- Pants should have long legs, shirts with long sleeves.
- DONOT WEAR SHORTS,
- DONOT WEAR TIES, SCARVES, JEWELRY.

Wear sturdy protective safety shoes or boots with non-skid soles;

- DONOT WEAR OPENTOED SHOES,
- DONOT OPERATE UNIT BAREFOOTED.

### *Hot Humid Weather*

Heavy protective clothing can increase operator fatigue, which may lead to heat stroke. Schedule heavy work for early morning or late afternoon hours when temperatures are cooler.



**Repetitive Stress Injuries --**

It is believed that overusing the muscles and tendons of the fingers, hands, arms and shoulders may cause soreness, swelling, numbness, weakness and extreme pain in those areas. Certain repetitive hand activities may put you at a high risk for developing a Repetitive Stress Injury (RSI). An extreme RSI condition is Carpal Tunnel Syndrome (CTS), which could occur when your wrist swells and squeezes a vital nerve that runs through the area. Some believe that prolonged exposure to vibration may contribute to CTS. CTS can cause severe pain for months or even years.

To reduce the risk of RSI/CTS, do the following:

- Avoid using your wrist in a bent, extended or twisted position. Instead try to maintain a straight wrist position. Also, when grasping, use your whole hand, not just the thumb and index finger.
- Take periodic breaks to minimize repetition and rest your hands.
- Reduce the speed and force with which you do the repetitive movement.
- Do exercises to strengthen the hand and arm muscles.
- Immediately stop using all power equipment and consult a doctor if you feel tingling, numbness or pain in the fingers, hands, wrists or arms. The sooner RSI/CTS is diagnosed, the more likely permanent nerve and muscle damage can be prevented.

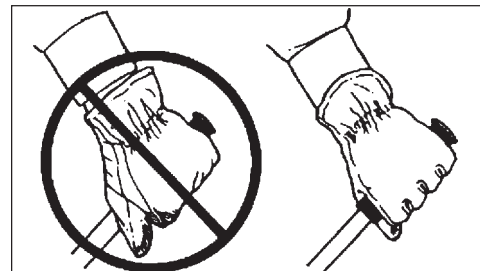

**Guide Bar and Saw Chain**



**DANGER**

- Serious injury may result from the use of non approved guide bar and saw chain combinations. Read and comply with all safety instructions listed in this manual.
- ECHO, INC. will not be responsible for the failure of cutting devices or accessories which have not been tested and approved by ECHO for use with this unit.

- Never adjust the guide bar or saw chain when the engine is operating.
- Check that the cutting attachment, guide bar and saw chain is firmly attached and in safe operating condition.
- Only use ECHO approved guide bar and saw chain.
- Do not hit rocks, stones, tree stumps and other foreign objects with the saw chain.
- Do not cut into the ground with the saw chain.
- If saw chain strikes an obstruction, stop engine immediately and inspect saw chain for damage.
- Do not operate with a dull, broken or discolored saw chain.
- Remove all foreign objects from work area.
- Always cover the guide bar and saw chain with guide bar cover during transportation and in storage.



**DANGER**

All over head electrical conductors and communications wires can have electricity flow with high voltages. Never touch wires directly or indirectly when pruning, otherwise serious injury or death may result.

## Read the Manuals

- Provide all operators of this equipment with the Operator's Manual, and instructions for safe operation.

## Clear the Work Area

- Spectators and fellow workers must be warned, and children and animals prevented from coming nearer than 15 m (50 ft.) while the unit is in use.

## Use Proper Clothing & Equipment

- Always wear head protection with full face shield to help protect against falling branches and debris.

## Keep A Firm Grip

- Hold the front and rear handles with both hands with thumbs and fingers encircling the handles

## Keep A Solid Stance

- Maintain footing and balance at all times. Do not stand on slippery, uneven or unstable surfaces. Do not work in odd positions or on ladders. Do not overreach.
- Operate the Power Pruner™ only from the ground or out of an approved bucket lift.
- Always evaluate the branches to be pruned for hazards such as loose dead branches which may fall and strike the operator or helpers. Remove hazards before pruning.
- Plan retreat path from falling objects.
- Cut branches bounce when striking ground.
- Turn the Power Pruner™ off when moving from tree to tree.
- Avoid any contact with saw chain.

## Avoid Hot Surfaces

- Keep exhaust area clear of flammable debris. Avoid contact during and immediately after operation.

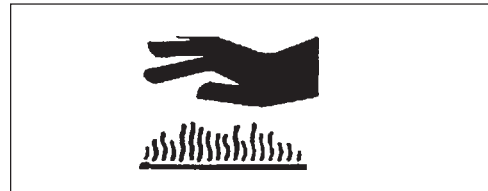

## KICKBACK



### DANGER

Kickback can lead to dangerous loss of control of the Power Pruner™ and result in serious injury to the operator or any one standing close by. Hold the Power Pruner™ firmly with both hands with thumbs and fingers encircling the front and rear handles. Be aware of the down and outward path the pruner will take after the cut is made.

Kickback may occur when the moving saw chain at the nose or tip of the guide bar touches an object, or when the wood closes in and pinches the saw chain in the cut. In some cases this may cause a lightning-fast reverse action, kicking the guide bar and saw chain up and back or down and back towards the operator. Either of these reactions may cause the operator to lose control of the Power Pruner™ which could result in serious personal injury.

With a basic understanding of kickback, you can reduce or eliminate the element of surprise which contributes to accidents.

Avoid contact of the guide bar tip with any object while the saw chain is moving.

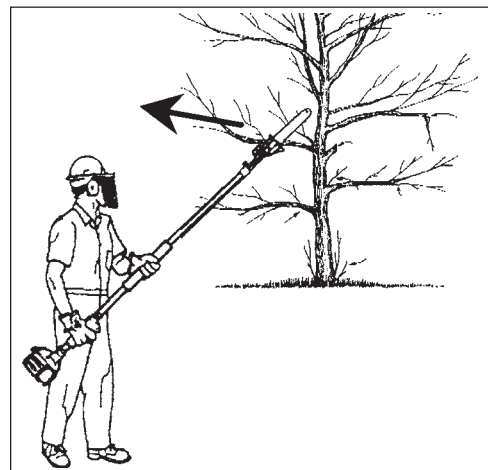

Cut only wood. Avoid striking concrete, metal, wire, or other obstructions which could cause kickback or damage to the saw chain.

If the saw chain does strike a foreign object, immediately stop the engine, inspect and repair the Power Pruner™ if necessary.

## EQUIPMENT

Before operation a complete check of the unit must be performed;

- Check unit for loose/missing nuts, bolts and screws. Tighten and/or replace as needed.

## DESCRIPTION

Locate this safety decal on your attachment. Make sure the decal is legible and that you understand and follow the instructions on it. If it cannot be read, a new one can be ordered from your ECHO dealer. See PARTS ORDERING instructions for specific information.

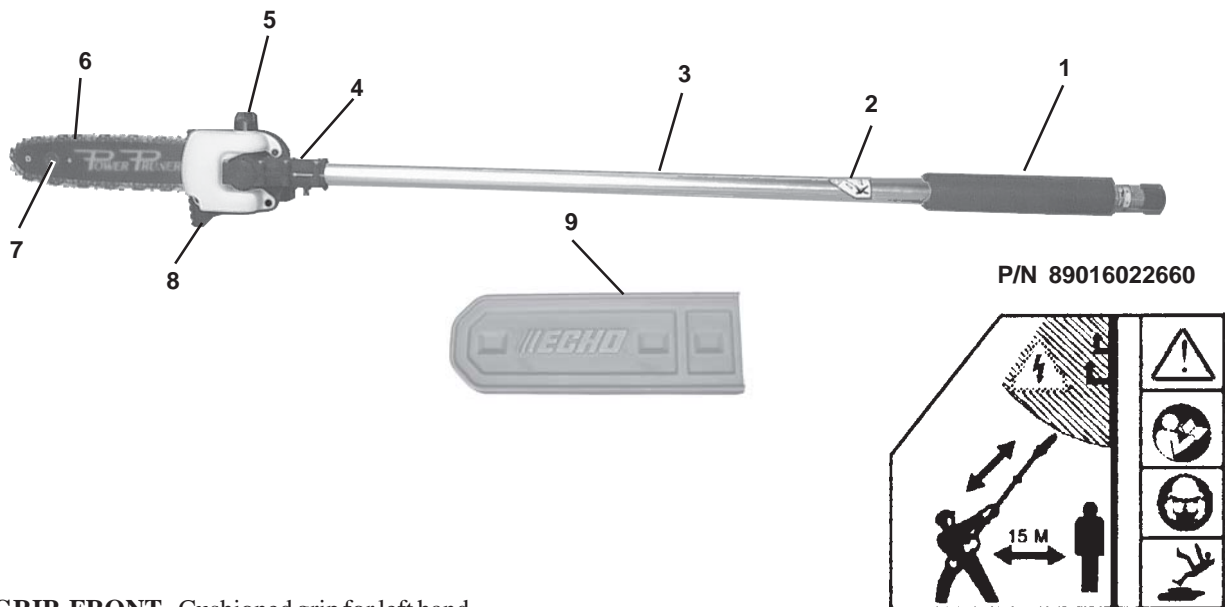

1. **GRIP, FRONT** - Cushioned grip for left hand.
2. **SHAFT DECAL** - Contain important safety information that must be followed.
3. **LOWER DRIVE SHAFT ASSEMBLY** - Contains a specially designed liner and the flexible drive shaft.
4. **CUTTING ATTACHMENT** - Sealed, gear ratio is 1.5:1 reduction.
5. **AUTOMATIC OILER ASSEMBLY** - Self oiling. Use high quality, low viscosity, non detergent bar and chain oil.
6. **SAW CHAIN** - 91 VX 9.53mm (3/8 inch) low profile Oregon® saw chain. Runs approximately 609.6 m/min. (2000 ft/min) at full throttle.
7. **GUIDE BAR** - 254 mm (10 inch) Bar
8. **CUTTING SHOE** - Used to capture and stabilize branch while cutting. Place cutting shoe against branch, accelerate and lower saw chain into branch.
9. **GUIDE BAR COVER** - Used to cover guide bar and saw chain during transport and storage. Remove guide bar cover before using unit.

## CONTENTS

The ECHO product you purchased has been factory pre-assembled for your convenience. After opening the carton, check for damage. Immediately notify your retailer or ECHO Dealer of damaged or missing parts. Use the contents list to check for missing parts.

- 1 - Power Pruner™ Attachment
- Plastic Bag (co-pack)
- Operator's Manual
- Safety Manual
- Warranty Registration Card
- Guide Bar Cover
- Safety Glasses
- Storage Hook Assembly

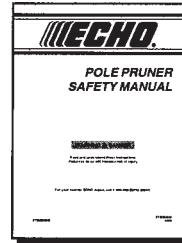
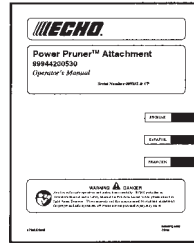

## ASSEMBLY

### POWER HEAD SHAFT/LOWER SHAFT ASSEMBLY

*Tools Required:* None

*Parts Required:* PAS or SRM-SB Power Head w/Shaft & Coupling.

1. Set Power Head/Shaft Assembly on a level surface.
2. Pull locator pin (A) out, and turn counter-clockwise 1/4 turn to lock-out position.
3. Remove vinyl cap from attachment drive shaft.
4. Carefully fit attachment drive shaft assembly into coupler (B) to decal assembly line (C), making sure that the inner lower drive shaft engages into the square upper drive shaft socket.

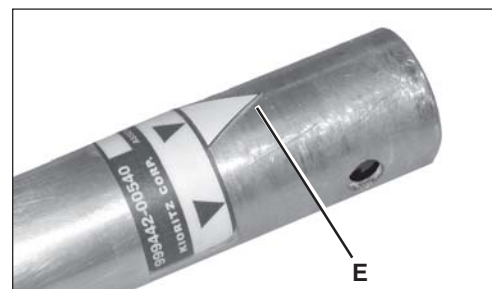
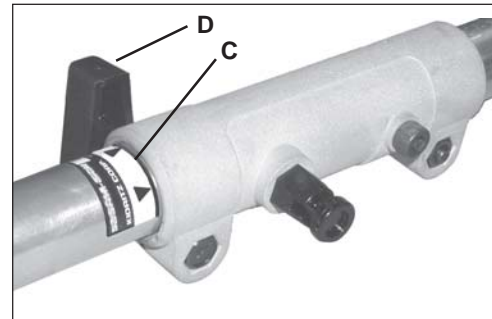
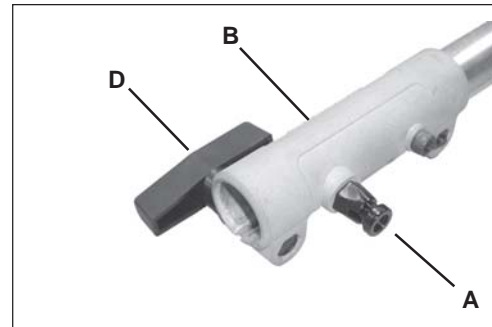

**NOTE**

Earlier model Power Heads may have shorter couplings. Short couplings fit flush to decal point (E). New couplings are 4-3/4 in. long, and fit flush to line (C).

**NOTE**

Lower bearing housing and head assembly must be in line with the engine.



5. Rotate locator pin (A) 1/4 turn clockwise to engage lower shaft hole. Insure locator pin is fully engaged by twisting lower drive shaft. Locator pin should snap flush in coupler. Full engagement will prevent further shaft rotation.
6. Secure lower shaft assembly to coupler by tightening clamping knob (D).

## FRONT LOOP HANDLE REMOVAL

*Tools Required:* Screwdriver.

*Parts Required:* None

### NOTE

Front loop handles/loop handles with barrier bars are not recommended for use with Power Pruner attachment.

1. Remove front handle assembly, barrier bar (if installed), and mounting hardware from PAS or SRM-SB power head.
2. Retain parts for future use.



## SAW CHAIN TENSION ADJUSTMENT

*Tools Required:* 10 mm (13/32 in.) Wrench, Screwdriver



### WARNING

Always wear gloves when handling saw chain, otherwise serious personal injury may result.

### *To Adjust Saw Chain Tension.*

1. Loosen two (2) 6 mm guide bar nuts (A) located on cutting attachment.
2. Turn the adjuster slot (B) clockwise until saw chain touches the bottom of guide bar. Turning adjuster slot (B) counter clockwise will loosen saw chain on guide bar.
3. Tighten guide bar nuts firmly. Move saw chain backwards on guide bar by hand. Saw chain should move freely on guide bar if it is in proper mesh with sprocket. If saw chain is difficult to rotate or binds on guide bar, it is too tight.

Keep the saw chain lubricated and properly adjusted and the guide bar nuts tightened firmly at all times.

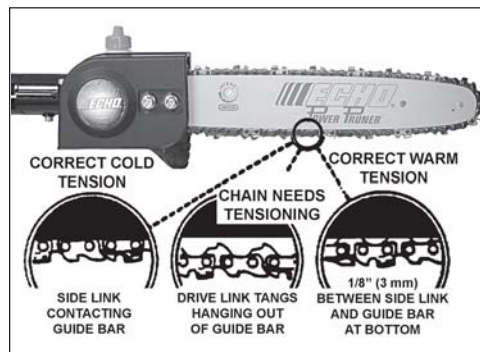
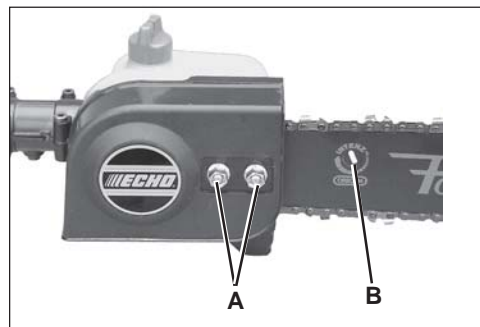

## OPERATION

### NOTE

Refer to your Pro Attachment Series power source or Split Boom Operator's Manual for correct engine fueling, starting and stopping instructions.

### IMPORTANT

Guide bar cover is for travel/storage only. Remove cover before using unit.

## LUBRICATING THE GUIDE BAR AND SAW CHAIN

### CHAIN

#### *Automatic Oiling System*

1. Wipe debris from around oil fill cap.
2. Remove oil fill cap and fill reservoir with a quality, low viscosity guide bar and saw chain oil.

### NOTE

The discharge volume of the automatic oiler is preset to deliver 3 to 4 cc/min. at normal operating RPM. During heavy or dry cutting conditions the oil discharge volume may be adjusted to assure adequate lubrication. Refill the oil reservoir with each tank of fuel.

### IMPORTANT

To prevent plastic deterioration, do not use synthetic or silicone based oil.



## ADJUSTING AUTOMATIC OILER

*Tools required:* 10 mm (13/32 in.) Wrench, Screwdriver

1. Remove two (2) 10 mm guide bar retaining nuts and sprocket cover.
2. From bottom of gear case, turn adjustment screw (A) clockwise to decrease oil volume - counter clockwise to increase oil volume.

### NOTE

Very little visible oil on the saw chain will provide sufficient lubrication.

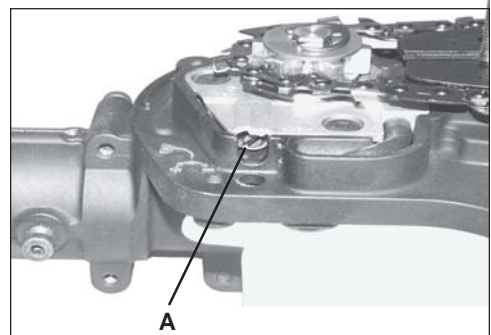

## PRUNING TECHNIQUES

The Power Pruner™ Attachment is designed for light to medium trimming of limbs and branches up to 203 mm (8 in.) in diameter. Follow these tips for successful operation.

- Plan cut carefully. Check direction branch will fall.
- Long branches should be removed in several pieces.
- Do not stand directly beneath branch being cut.
- When ready to cut:  
Hold "cutting shoe" against branch. This will prevent whipping of the branch. DO NOT use back and forth sawing action.
- Look out for branches immediately behind the branch being cut. If saw chain hits rear branch, damage to the saw chain may occur.
- Accelerate to full throttle.
- Apply cutting pressure.
- Ease cutting pressure when nearing end of cut to maintain control.
- When pruning a limb 102 mm (4 in.) diameter or larger cut as follows:
  1. Under cut 1/4 limb diameter near tree trunk.
  2. Finish top cut slightly farther out on limb.
  3. Flush cut stub at trunk.
- DO NOT use for felling or bucking.

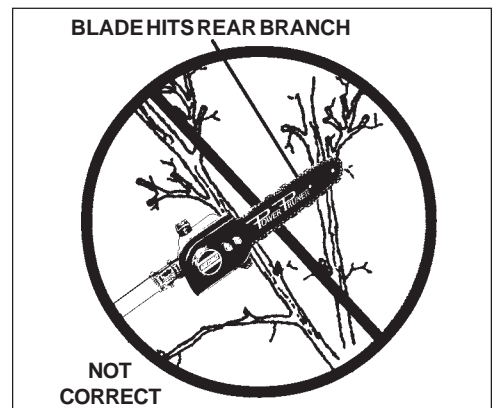
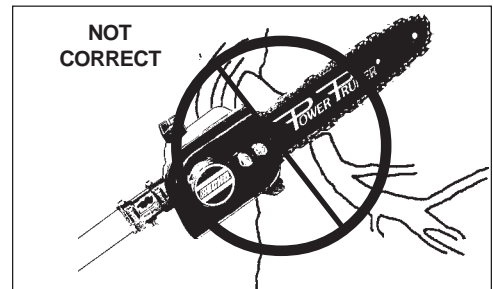
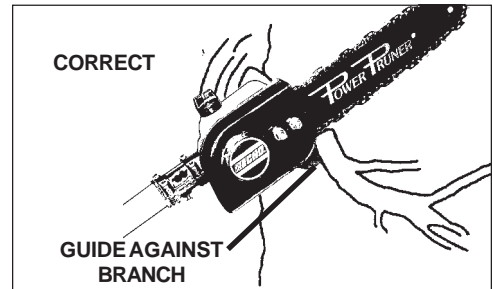

## MAINTENANCE

Your ECHO Pruner attachment is designed to provide many hours of trouble free service. Regular scheduled maintenance will help your Pruner attachment achieve that goal. If you are unsure or are not equipped with the necessary tools, you may want to take your unit to an ECHO Service Dealer for maintenance. To help you decide whether you want to DO-IT-YOURSELF or have the ECHO Dealer do it, each maintenance task has been graded. If the task is not listed, see your ECHO Dealer for repairs.

## SKILL LEVELS

- Level 1** = Easy to do. Most required tools come with unit.
- Level 2** = Moderate difficulty. Some specialized tools may be required.
- Level 3** = Experience required. Specialized tools are required. ECHO recommends the unit be returned to your ECHO Dealer for service.

## MAINTENANCE INTERVALS

<u>Component/System</u>	<u>Maintenance Procedure</u>	<u>Skill Level</u>	<u>Frequency</u>
Drive Shaft	Grease	1	Every 25 hours of use
Guide Bar	Inspect/Replace/Lubricate	2	Before each use
Saw Chain	Inspect/Sharpen/Replace/Lubricate	2	Before each use
Screws/Nuts/Bolts	Inspect/Tighten/Replace	1	Before each use

## LUBRICATION

### *Drive Shaft (Lower)*

#### Level 1

*Tools Required:* 4 mm L-Wrench

*Parts Required:* ECHO<sup>®</sup> LUBE™ 8 oz. (P/N 91014) or Lithium Base Grease.



#### **IMPORTANT**

Lower and upper drive shaft must be lubricated with high temperature automotive grease every 25 hours of operation, otherwise drive shaft assembly overheating and failure can result.

1. Remove the cutting attachment from the Power Pruner™ shaft housing by removing the location bolt (B), loosening the (4) four bolts (A) clamping the cutting attachment to the shaft housing, and slide the cutting attachment off.
2. Remove lower flex cable, wipe clean, and apply a thin coat 15ml (1/2 oz.) of high temperature automotive grease.

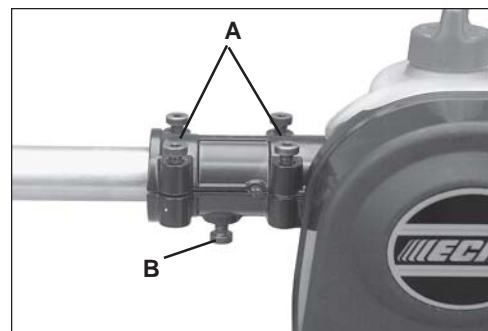

3. Slide the cutting attachment onto the shaft housing until the hole in the neck of the cutting attachment is aligned with the hole (C) in the housing (It may be necessary to rotate the saw chain slightly to align the internal pinion and drive shaft.)
4. Insert location bolt (B) into hole (C) and tighten to snug.
5. Tighten bolts (A), clamping the cutting attachment onto the housing.

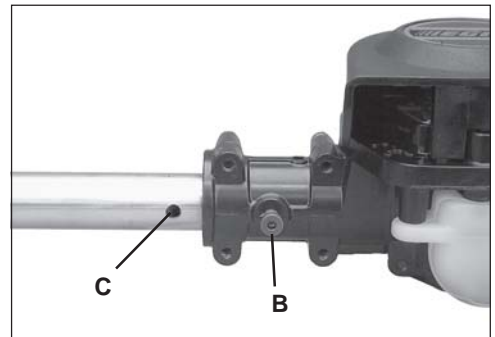

## GUIDE BAR AND SAW CHAIN REPLACEMENT



### WARNING

Never try to replace or adjust guide bar and saw chain with engine running. Always disconnect spark plug wire before servicing guide bar and saw chain. This saw chain is VERY sharp, wear heavy gloves to protect your hands when handling it. Wear eye protection meeting CE or ANSI specification Z87.1.

### *Guide Bar Replacement / Installation*

#### Level 2

*Tools Required:* 10x19 mm (13/32x3/4 in.) T-wrench

1. Remove two (2) 6 mm guide bar nuts (A), and turn saw chain tension adjustment slot (B) counterclockwise to release tension.
2. Remove sprocket cover (C).
3. Remove guide bar and saw chain from gear case and sprocket.
4. Remove chain from guide bar and check guide bar for damage and excessive or uneven wear. Replace guide bar if necessary.

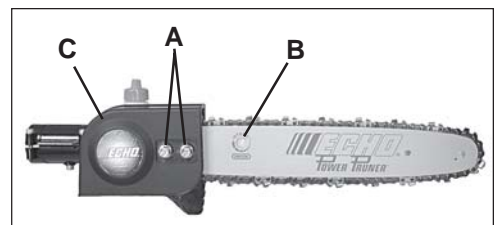

5. Turn saw chain tension adjuster slot (B) counterclockwise until it stops.
6. Install chain on guide bar with cutters on top of bar facing toward bar tip.
7. Install guide bar and chain on gear case, engaging chain with drive sprocket (D).
8. Turn tension adjustment slot clockwise to take up slack in saw chain.
9. Install sprocket guard (C), and tighten guide bar nuts finger tight.
10. Adjust chain tension.

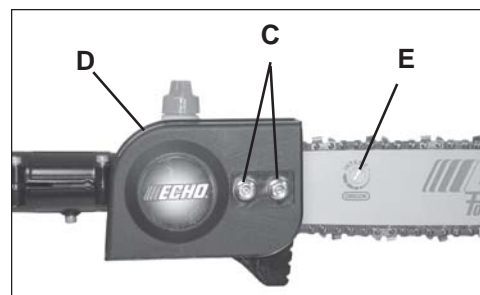
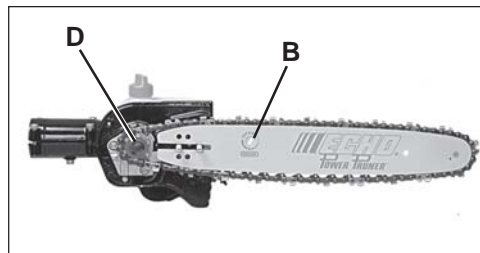

### ***To Adjust Saw Chain Tension.***

1. Loosen two guide bar nuts (A), if necessary.
2. Turn saw chain adjuster slot (B) clockwise to tighten saw chain on guide bar. Turning slot counter clockwise will loosen saw chain on guide bar.
3. Tighten guide bar nuts (A) firmly. Pull the saw chain around the guide bar by hand. Saw chain should move freely on guide bar. If saw chain is difficult to rotate or binds on guide bar, it is too tight.
4. Keep the saw chain lubricated and properly adjusted and the guide bar nuts tightened firmly at all times.

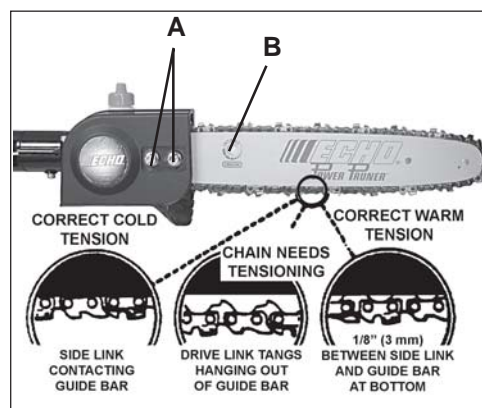

## FILING SAW CHAIN

Level 3.

Tools Required: 4 mm (5/32 in.) round File  
Flat File  
Depth Gauge

### IMPORTANT

Dull or damaged cutters will result in poor cutting performance, increased vibration and premature chain failure.



### WARNING

Always stop engine and wear gloves when filing saw chain, otherwise serious personal injury may result.

1. Set round file (A) in cutter at 30° angle. One fifth (1/5) of the file should be exposed above top cutter edge.
2. Keep file horizontal in cutter and file in one direction.
3. File until cutter top and side bevel edges are sharp without nicks.
4. Place depth gauge tool (B) firmly on top of cutter with .025" slot and end against front cutter raker. File cutter raker with flat file until flush with top of depth gauge.
5. Finish cutter sharpening by rounding front raker edge (C) with flat file.
6. Properly filed cutter is as shown.
7. Apply clean oil and rotate saw chain slowly to wash away filings.
8. If saw chain is coated or clogged with resin, clean in kerosene then soak in oil.

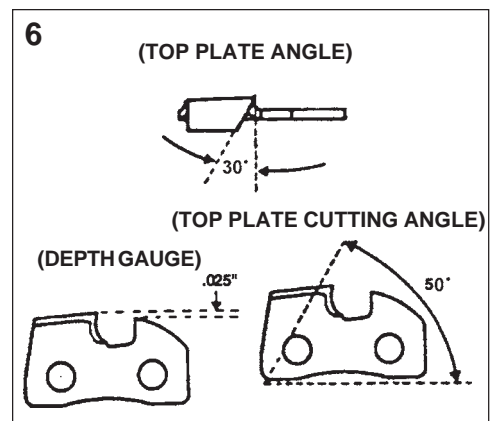
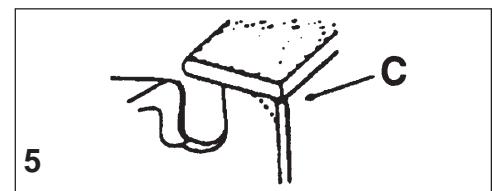
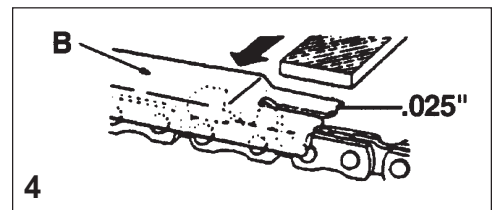
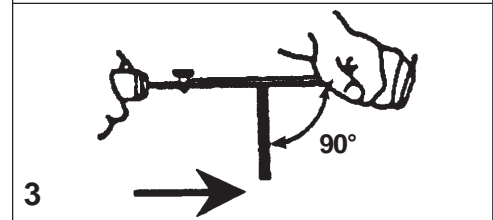
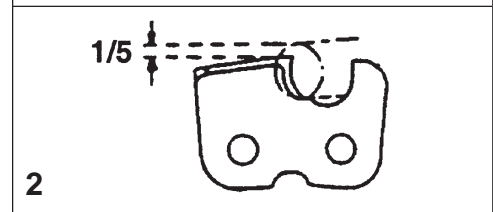
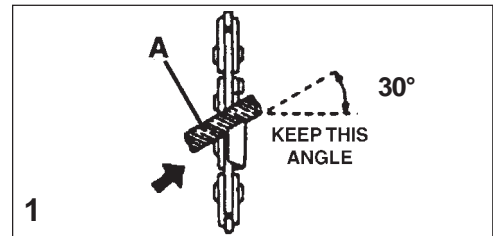

## Standard Bar and Chain Combinations

	Bar P/N	Chain P/N	chain type	links	pitch	gauge
PPF-210 PPT-230 99944200530	10" Intenz™ bar 1102373901	1917039	91	39	3/8"	0.050
PPT-260	12" Intenz™ bar 1122374401	1917044	91	44	3/8"	0.050

## Optional Bar and Chain Combinations

	Bar P/N	Chain P/N	chain type	links	pitch	gauge
PPF-210 99944200530	8" regular bar 1080373301	1917033	91	33	3/8"	0.050
	10" regular bar 1101373901	1917039	91	39	3/8"	0.050
	10" narrow bar 1100373901	1907039	90	39	3/8"	0.043
PPT-230 PPT-260	10" regular bar 1101373901	1917039	91	39	3/8"	0.050
	10" narrow bar 1100373901	1907039	91	39	3/8"	0.050
	12" regular bar 1121374401	1917044	91	44	3/8"	0.050
	12" narrow bar 1120374401	1907044	90	44	3/8"	0.043

When converting from Intenz™ guide bar to regular or narrow kerf guide bar, see your Echo dealer for additional parts needed.

### **IMPORTANT**

Chain and guide bar gauge size must be identical. Use Bar/Chain combinations shown in table above.



## STORAGE

### *Storage Hook Installation*

1. Insert small end of hook into locating hole on attachment shaft.
2. Slide plastic cap onto end of attachment shaft.

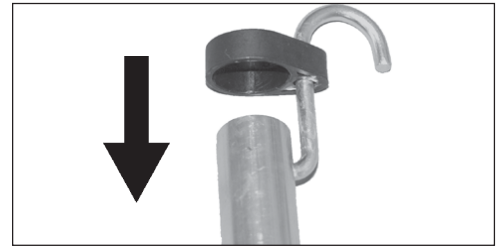

## SPECIFICATIONS

MODEL .....	99944200530 POWERPRUNER™ ATTACHMENT
Length .....	1448 mm (57.0 in.)
Width .....	102 mm (4.0 in.)
Height .....	140 mm (5.5 in.)
Weight .....	2.19 kg (4.84 lbs.)
Sprocket Type .....	6 tooth spur, 9.53 (3/8 in.) pitch
Drive Shaft .....	1/4 in. Flex Cable
Gear Reduction Ratio .....	1.5:1
Oiling System .....	Automatic
Handle .....	Left foam grip
Guide Bar and Saw Chain .....	254 mm (10 in.), 9.53 mm (3/8 in.) pitch, .050 in. gauge, 91 VX chain.

NOTES

**NOTES**



## SERVICING INFORMATION

### PARTS/SERIAL NUMBER

Genuine ECHO Parts and ECHO REPOWER™ Parts and Assemblies for your ECHO products are available only from an Authorized ECHO Dealer. When you do need to buy parts **always** have the Model Number and Serial Number of the attachment with you. You can find these numbers on the driveshaft model/serial number label. For future reference, write them in the space provided below.

Model No. \_\_\_\_\_ SN. \_\_\_\_\_

### SERVICE

Service of this product during the warranty period must be performed by an Authorized ECHO Service Dealer. For the name and address of the Authorized ECHO Service Dealer nearest you, ask your retailer or call: 1-800-432-ECHO (3246). When presenting your unit for Warranty service/repairs, proof of purchase is required.

### ECHO CONSUMER PRODUCT SUPPORT

If you require assistance or have questions concerning the application, operation or maintenance of this product you may call the ECHO Consumer Product Support Department at 1-800-673-1558 from 8:30 am to 4:30 pm (Central Standard Time) Monday through Friday. Before calling, please know the model and serial number of your unit to help your Consumer Product Support Representative.

### WARRANTY REGISTRATION

To ensure trouble free warranty coverage it is important that you register your ECHO equipment on-line at [www.echo-usa.com](http://www.echo-usa.com). Other registration options are by automated phone at 1-800-432-3246 or by filling out the warranty registration card supplied with your unit. Registering your product confirms your warranty coverage and provides a direct link between you and ECHO if we find it necessary to contact you.

### ADDITIONAL OR REPLACEMENT MANUALS

**Safety Manuals** in English/Spanish or English/French are available, free of charge, from your ECHO dealer or at [www.echo-usa.com](http://www.echo-usa.com).

**Operator's and Parts Manuals** are available by:

- Downloading free from [www.echo-usa.com](http://www.echo-usa.com)
- Purchasing from your Echo Dealer.
- Manuals are available by sending a written request stating the model number and serial number of your Echo unit, part number of the manual, your name and address, and mail to the address below.

**Safety Videos** are available from your Echo dealer. A \$5.00 shipping charge will be required for each video.



### DEALER?

Call

**1-800-432-ECHO**

or

**[www.echo-usa.com](http://www.echo-usa.com)**

### CONSUMER PRODUCT SUPPORT

**1-800-673-1558**

**8:30 - 4:30 Mon - Fri C.S.T.**

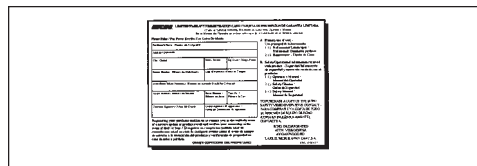

# ECHO®

ECHO, INCORPORATED

400 OAKWOOD ROAD

LAKE ZURICH, IL 60047-1564

[WWW.ECHO-USA.COM](http://WWW.ECHO-USA.COM)

008666/999999