



Propane Cooker  
Cocotte à propane  
Cocinador a Propano

### 9935 Series

INSTASTART™ Electronic Ignition  
INSTASTART™ Allumage électronique  
INSTASTART™ Encendido electrónico

Instructions for use  
Notice d'emploi  
Instrucciones de uso

© 2005 The Coleman Company, Inc.  
www.coleman.com

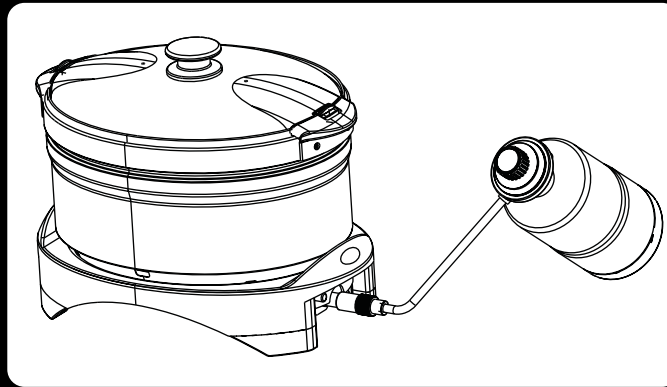

Patents Pending  
Brevets en instance  
Patentes Pendientes



ANSI Z21.72b - CSA 11.2b (2002)  
Camp Stove  
Poêle de camping  
Estufa de campamento

#### IMPORTANT

Read this manual carefully before setting up, using or servicing this cooker. Keep this manual for future reference. If you have questions about set-up, operation, servicing or repair of this cooker, please call Coleman at 1-800-835-3278 or TDD: 316-832-8707. In Canada call 1-800-387-6161.

#### IMPORTANT

Lisez attentivement ce manuel avant de mettre la cocotte en place, de l'utiliser ou de l'entretenir et gardez-le pour référence ultérieure. Pour toute question relative à la mise en place, au fonctionnement, à l'entretien ou à la réparation, appelez Coleman au 1 800 835-3278 ou ATS 316-832-8707 aux États-Unis et au 1 800 387-6161 au Canada.

#### IMPORTANTE

Lea este manual cuidadosamente antes de ensamblar, usar o reparar este cocinador. Guarde este manual para uso de referencia en el futuro. Si tiene alguna pregunta acerca del ensamblaje, uso, compostura o reparaciones a este cocinador, por favor llame a Coleman al 1-800-835-3278 o TDD: 316-832-8707. En Canadá llame al 1-800-387-6161.

## FOR YOUR SAFETY

If you smell gas:

1. Do not attempt to light appliance.
2. Extinguish any open flame.
3. Disconnect from fuel supply.

## FOR YOUR SAFETY

Do not store or use gasoline or other liquids with flammable vapors in the vicinity of this or any other appliance.

## ⚠ DANGER



### CARBON MONOXIDE HAZARD

- This appliance can produce carbon monoxide which has no odor.
- Using it in an enclosed space can kill you.
- Never use this appliance in an enclosed space such as a camper, tent, car or home.

This manual contains important information about the assembly, operation and maintenance of this outdoor propane appliance. General safety information is presented on this page and is also located throughout these instructions. Particular attention should be paid to information accompanied by the safety alert symbol "⚠ DANGER", "⚠ WARNING", "⚠ CAUTION".

Keep this manual for future reference and to educate new users of this product. This manual should be read in conjunction with the labeling on the product.

Safety precautions are essential when any mechanical or propane fueled equipment is involved. These precautions are necessary when using, storing, and servicing. Using this equipment with the respect and caution demanded will reduce the possibilities of personal injury or property damage.

The following symbols shown below are used extensively throughout these instructions. Always heed these precautions, as they are essential when using any mechanical or propane fueled equipment.

## ⚠ DANGER

DANGER indicates an imminently hazardous situation which, if not avoided, will result in death or serious injury.

## ⚠ WARNING

WARNING indicates a potentially hazardous situation which, if not avoided, could result in death or serious injury.

## ⚠ CAUTION

CAUTION indicates a potentially hazardous situation which, if not avoided, may result in minor or moderate personal injury, or property damage.

## ⚠ DANGER

Failure to comply with the precautions and instructions provided with this cooker can result in death, serious bodily injury and property loss or damage from hazards of fire, explosion, burn, asphyxiation, and/or carbon monoxide poisoning.

Only persons who can understand and follow the instructions should use or service this cooker.

If you need assistance or information such as an instruction manual or labels, contact The Coleman Company, Inc.

### CALIFORNIA PROPOSITION 65:

**WARNING:** This fuel, and byproducts of combustion of this fuel, contain chemicals known to the state of California to cause cancer, birth defects, or other reproductive harm.

## WARNING

- This product is fueled by propane gas. Propane gas is invisible, odorless, and flammable. An odorant is normally added to help detect leaks and can be described as a "rotten egg" smell. The odorant can fade over time so leaking gas is not always detectable by smell alone.
- Propane gas is heavier than air and leaking propane will sink to the lowest level possible. It can ignite by ignition sources including matches, lighters, sparks or open flames of any kind many feet away from the original leak. Use only propane gas set up for vapor withdrawal.
- Propane gas should be stored or used in compliance with local ordinances and codes or with ANSI/NFPA 58. Turn off propane when not in use.

## DANGER



### • EXPLOSION - FIRE HAZARD

- Never store propane near high heat, open flames, pilot lights, direct sunlight, other ignition sources or where temperatures exceed 120 degrees F (49°C).
- Propane is heavier than air and can accumulate in low places. If you smell gas, leave the area immediately.
- Never install or remove propane tank while outdoor cooker is lighted, near flame, pilot lights, other ignition sources or while outdoor cooker is hot to touch.
- During lighting and operation, this product can be a source of ignition. Never use the cooker in spaces that contain or may contain volatile or airborne combustibles, or products such as gasoline, solvents, paint thinner, dust particles or unknown chemicals. Minimum clearances from combustible materials: 12 inches from the sides and 48 inches from the top.
- Provide adequate clearances around air openings into the combustion chamber.

## WARNING

Not for home or recreational vehicle use.

We cannot foresee every use which may be made of our products.

**Check with your local fire safety authority if you have questions about use.**

Other standards govern the use of fuel gases and heat producing products for specific uses. Your local authorities can advise you about these.

- Never refill disposable cylinders.
- Use the preset regulator that came with the cooker. Do not attempt to adjust.
- Use only Coleman® accessories or parts. During cooker set-up, check all fittings for leaks using soapy water. Never use a flame.

## WARNING



### • BURN HAZARD

- Never leave cooker unattended when hot or in use.
- Do not use as a deep fat fryer.
- Keep out of reach of children.

## DANGER



### • CARBON MONOXIDE HAZARD

- This cooker is a combustion appliance. All combustion appliances produce carbon monoxide (CO) during the combustion process. This product is designed to produce extremely minute, non-hazardous amounts of CO if used and maintained in accordance with all warnings and instructions. Do not block air flow into or out of the cooker.
- Carbon Monoxide (CO) poisoning produces flu-like symptoms, watery eyes, headaches, dizziness, fatigue and possibly death. You can't see it and you can't smell it. It's an invisible killer. If these symptoms are present during operation of this product **get fresh air immediately!**
- **For outdoor use only.**
- **Never use inside house, camper, tent, vehicle or other unventilated or enclosed areas. This cooker consumes air (oxygen). Do not use in unventilated or enclosed areas to avoid endangering your life.**

## CAUTION

### • SERVICE SAFETY

- Keep all connections and fittings clean. Inspect propane cylinder and cooker propane connections for damage before attaching.
- During set up, check all connections and fittings for leaks using soapy water. Never use a flame. Bubbles indicate a leak. Check that the connection is not cross-threaded and that it is tight. Perform another leak check. If there is still a leak, remove the cylinder and contact Coleman for service or repairs.
- Use as a cooking appliance only. Never alter in any way or use with any device or part not expressly approved by Coleman.

## Technical Characteristics

Input: 4,000 BTU/HR  
Category: Pressure regulated propane  
Fuel: 16.4 oz. disposable propane cylinders  
Regulator: 9935

## To Set Up

### ⚠ DANGER



#### • CARBON MONOXIDE HAZARD

- For outdoor use only.
- Never use inside house, camper, tent, vehicle or other unventilated or enclosed areas. This cooker consumes air (oxygen). Do not use in unventilated or enclosed areas to avoid endangering your life.

### ⚠ CAUTION

- When cooking, the appliance must be on a level, stable surface in an area clear of combustible material. An asphalt surface (blacktop) may not be acceptable for this purpose.
- Do not place empty cooking vessel in the appliance while in operation. Use caution when placing anything in cooking vessel while the appliance is in operation.
- Do not move the appliance when in use. Allow the cooking vessel to cool before moving or storing.
- This appliance is not intended for and should never be used as a heater.

NOTE: Use Coleman® 16.4 oz. disposable propane cylinders. The LP-gas cylinder(s) used with cookers must be constructed and marked in accordance with the specifications for LP-gas cylinders of the U.S. Department of Transportation or Transport Canada, CAN/CSA B339.

- Remove components from carton. (Fig. 1)

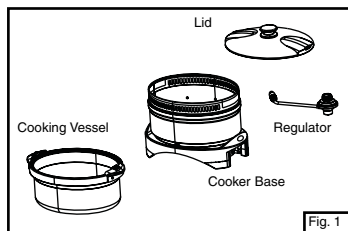

#### Note:

- Wash the cooking vessel and lid before first use.
- Prepare the food and place in the cooking vessel. Cover with the lid. Release the lid latch before installing or removing the lid. (Fig. 2)
- Do not place the cooking vessel into the cooker until after lighting the burner.

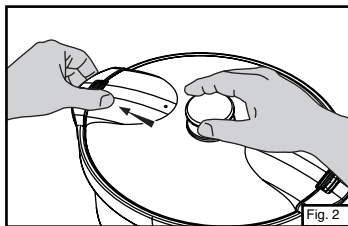

### ⚠ CAUTION

#### • SERVICE SAFETY

- Keep all connections and fittings clean. Inspect propane cylinder and cooker propane connections for damage before attaching.
- During set up, check all connections and fittings for leaks using soapy water. Bubbles indicate a leak. Never use a flame.

- Turn off regulator valve. (Fig. 3)

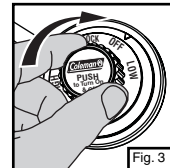

- Push in and screw regulator into cooker hand tight. (Fig. 4)

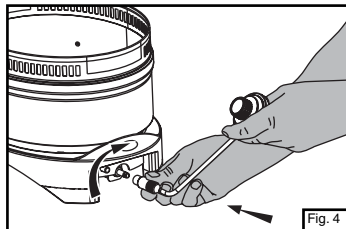

- Remove protective cap from top of propane cylinder. Save cap for use in storing. (Fig. 5)
- Screw propane bottle into regulator hand tight. (Fig. 6)

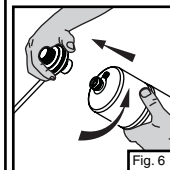

- Propane cylinder correctly installed. (Fig. 7)
- Never operate cooker with propane cylinder in an inverted position. (Fig. 8)

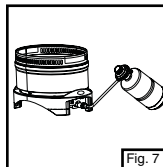

## Leak Check

### ⚠ WARNING

- Perform leak test outdoors.
- Extinguish all open flames.
- NEVER leak test when smoking.
- Do not use the outdoor cooker until connection has been leak tested and does not leak.

## To Light

### **⚠ DANGER**



#### • EXPLOSION - FIRE HAZARD

- Propane is heavier than air and can accumulate in low places. If you smell gas, leave the area immediately.
- Always attach or detach propane source outdoors; never while cooker is lighted, near flame, pilot lights, other ignition sources or while cooker is hot to touch.
- This cooker is very hot during use and can ignite flammables too close to the burners. Keep flammables at least 12 inches from the sides and 48 inches from the top of the cooker. Keep gasoline and other flammable liquids and vapors well away from cooker.
- The cooker must not be exposed to flammable vapors or liquids during lighting.

### **⚠ WARNING**



#### • BURN HAZARD

- Never leave cooker unattended when hot or in use.
- Keep out of reach of children.

## INSTASTART™

### Electronic Ignition Cooker

- Remove cooking vessel from cooker base before lighting.
  - Set on sturdy, flat surface. **For outdoor use only.**
  - Open regulator valve and push igniter button repeatedly until burner lights. (Fig. 9 and 10)
- Note: If igniter fails to light cooker, use match to light burner. If the cooker is wet the igniter may not spark.

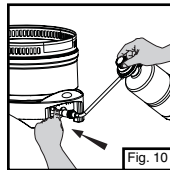
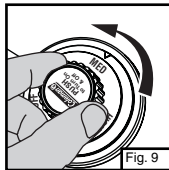

- Carefully view the burner flame through the observation hole. The burner is located inside at the bottom of the cooker base. (Fig. 11)
- A good flame should be blue with minimal yellow tip. Some yellow tips on flames are acceptable as long as no carbon or soot deposits appear.

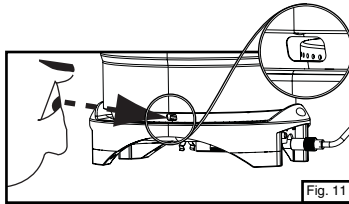

- Adjust flame with regulator valve. (Fig. 12)

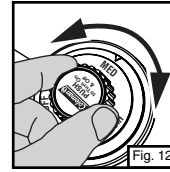

## Match Lighting

### **⚠ CAUTION**

Use a LONG wooden match or a match extension.

- Remove cooking vessel from cooker base before lighting.
- Set on sturdy, flat surface. **For outdoor use only.**
- Insert long lighted match through observation hole. Place flame near burner and open regulator valve. (Fig. 13)

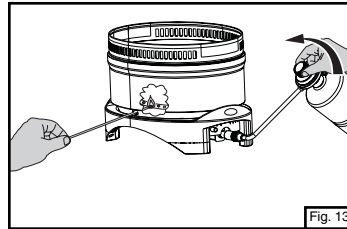

- Carefully view the burner flame through the observation hole. The burner is located inside at the bottom of the cooker base. (Fig. 11)
- Flame should be blue with a hint of yellow on tips.

- Adjust flame with regulator valve. (Fig. 14)

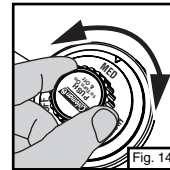

## Install Cooking Vessel

- Carefully place the cooking vessel with food into the cooker base. (Fig. 15)



## To Cook

- The cooking temperature is not automatically regulated.
- Manually adjust the temperature with the regulator valve.
- Continuously monitor the cooking process while using the cooker. Adjust the temperature and/or stir the food as necessary.
- Follow the recommended food preparation instructions on the food packages.
- Cooking times may vary depending on weather conditions and altitude.

## To Turn Off

- Turn off regulator valve. (Fig. 16)

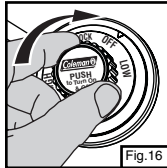

## To Clean

- Make sure cooker is cool.
- Remove cooking vessel from cooker base.
- Move cooker away from flame (including pilot lights) and other ignition sources.
- Remove propane cylinder from regulator and replace protective cap on cylinder. (Fig. 17)

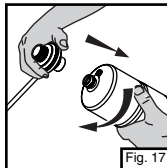

- Remove regulator from cooker. (Fig. 18)

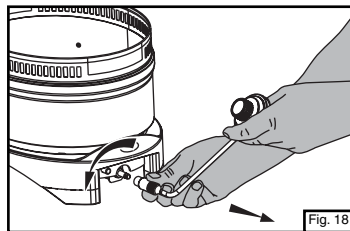

### • MAINTENANCE

- Keep cooker area clear and free from combustible materials, gasoline and other flammable vapors and liquids.
- Do not obstruct the flow of combustion and ventilation air.
- A good flame should be blue with minimal yellow tip. Some yellow tips on flames are acceptable as long as no carbon or soot deposits appear.
- Wipe clean with soft cloth and mild dish detergent. Do not use oven cleaners or abrasives.

## To Store

### ⚠ DANGER



#### • EXPLOSION - FIRE HAZARD

- Never store propane near high heat, open flames, pilot lights, direct sunlight, other ignition sources or where temperatures exceed 120 degrees F (49°C).
- The cylinder must be disconnected when the cooker is in storage.
- Never store a propane cylinder inside the cooker. (Fig. 19)

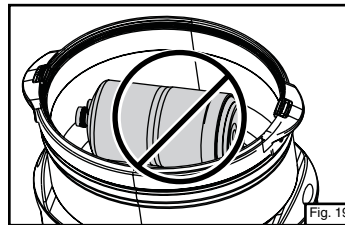

- For storage or transport, place the regulator in the clips below the cooker. (Fig. 20)

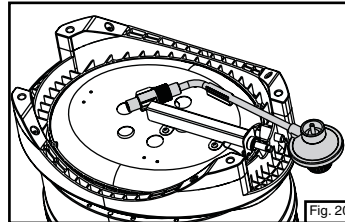

## To Carry

- Make sure cooker is cool.
- To carry the cooker, firmly grasp the cooker by the base. (Fig. 21)



## Parts List

No.	Part Number	Description
1	9935-5211	Lid Assembly
2	9935-5221	Cooking Vessel Assembly w/ Handles
3	9935A1631	Handle Assembly (1 pk)
4	9935-5911	Electrode & Ignitor
5	9935-5251	Regulator Asm

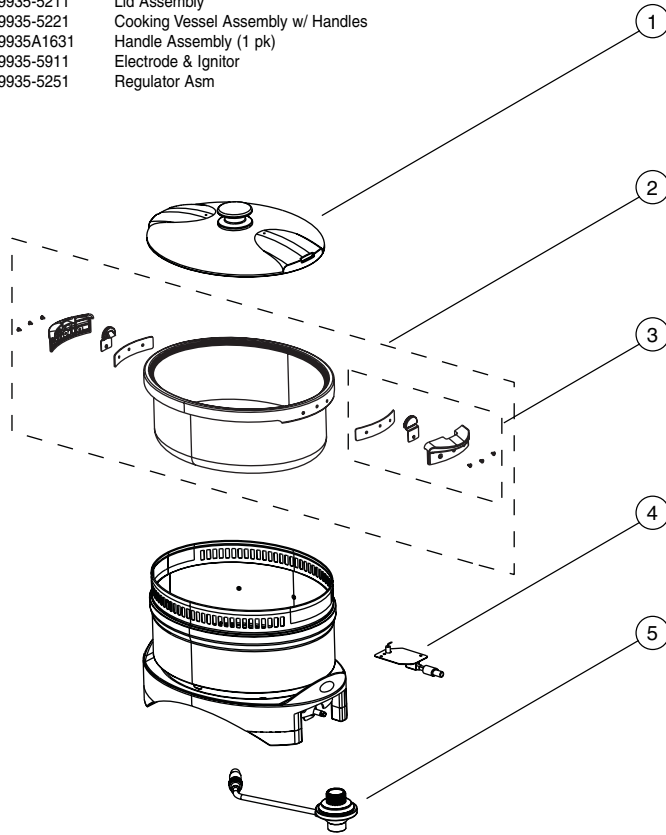

## Accessories (sold separately)

No.	Part Number	Description
6	R9935-100C	Carry Bag

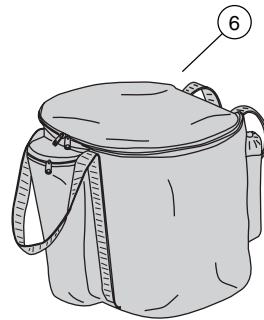

## Things You Should Know

1. It is unsafe and illegal in some places to store or use propane cylinders of greater than 1.14 kg (2.5 lbs) water capacity (approximately 1 lb. propane) in occupied enclosures.
2. The usual storage areas for camping and picnic equipment are the basement, attic, or garage. To avoid the accumulation of dust, cobwebs, etc., that is common in these areas, place your appliance in the accessory carry bag (sold separately). Otherwise, you may place your appliance in a plastic bag and seal it with a rubber band.
3. Do not freeze cooking vessel and/or lid.
4. For repair service call one of the numbers on the front cover for location of your nearest Coleman Service Center. If a service center is not conveniently located, attach to the product a tag that includes your name, address, daytime telephone number and description of the problem. Carefully package the product and send either by **courier** or **insured mail** with shipping and **insurance** prepaid to:

### For products purchased in the United States:

The Coleman Company, Inc.  
3600 North Hydraulic  
Wichita, KS 67219

### For products purchased in Canada:

Sunbeam Corporation (Canada) Limited  
5975 Falbourne Street  
Mississauga, Ontario  
Canada L5R 3V8

5. If not completely satisfied with the performance of this product, please call 1-800-835-3278 or TDD 316-832-8707 in the US or 1 800 387-6161 in Canada.

[www.coleman.com](http://www.coleman.com)

## Warranty

### Limited Five Year Warranty

The Coleman Company, Inc. ("Coleman") warrants that for a period of five years from the date of original retail purchase, this product will be free from defects in material and workmanship. Coleman, at its option, will repair or replace this product or any component of the product found to be defective during the warranty period. Replacement will be made with a new or remanufactured product or component. If the product is no longer available, replacement may be made with a similar product of equal or greater value. This is your exclusive warranty.

This warranty is valid for the original retail purchaser from the date of initial retail purchase and is not transferable. Keep the original sales receipt. Proof of purchase is required to obtain warranty performance. Coleman dealers, service centers, or retail stores selling Coleman® products do not have the right to alter, modify or in any way change the terms and conditions of this warranty.

### What This Warranty Does Not Cover

This warranty does not cover normal wear of parts, parts that are not genuine Coleman® parts, or damage resulting from any of the following: negligent use or misuse of the product; use on improper voltage or current; commercial use of the product; use contrary to the operating instructions; disassembly, repair or alteration by anyone other than Coleman or an authorized service center. Further, the warranty does not cover Acts of God, such as fire, flood, hurricanes and tornadoes. Warranty void if damage to product results from the use of a part other than a genuine Coleman® part.

**COLEMAN SHALL NOT BE LIABLE FOR DEFECTS THAT ARE CAUSED BY THE USE OF UNAUTHORIZED PARTS OR SERVICE. COLEMAN SHALL NOT BE LIABLE FOR ANY INCIDENTAL OR CONSEQUENTIAL DAMAGES CAUSED BY THE BREACH OF ANY EXPRESS OR IMPLIED WARRANTY OR CONDITIONS. EXCEPT TO THE EXTENT PROHIBITED BY APPLICABLE LAW, ANY IMPLIED WARRANTY OF MERCHANTABILITY OR FITNESS FOR A PARTICULAR PURPOSE IS LIMITED IN DURATION TO THE DURATION OF THE ABOVE WARRANTY OR CONDITIONS. SOME STATES, PROVINCES, OR JURISDICTIONS DO NOT ALLOW THE EXCLUSION OR LIMITATION OF INCIDENTAL OR CONSEQUENTIAL DAMAGES OR LIMITATIONS ON HOW LONG AN IMPLIED WARRANTY LASTS, SO THE ABOVE LIMITATIONS OR EXCLUSION MAY NOT APPLY TO YOU. THIS WARRANTY GIVES YOU SPECIFIC LEGAL RIGHTS, AND YOU MAY ALSO HAVE OTHER RIGHTS THAT VARY FROM STATE TO STATE OR PROVINCE TO PROVINCE.**

### How to Obtain Warranty Service

Take the product to an authorized Coleman service center. You can find the nearest authorized Coleman service center by visiting [www.coleman.com](http://www.coleman.com) or calling 1-800-835-3278 or TDD 316-832-8707 in the United States or 1 800 387-6161 in Canada. If a service center is not conveniently located, attach to the product a tag that includes your name, address, daytime telephone number and description of the problem. Include a copy of the original sales receipt. Carefully package the product and send either by **courier** or **insured mail** with shipping and **insurance** prepaid to:

### For products purchased in the United States:

The Coleman Company, Inc.  
3600 North Hydraulic  
Wichita, KS 67219

### For products purchased in Canada:

Sunbeam Corporation (Canada) Limited  
5975 Falbourne Street  
Mississauga, Ontario  
Canada L5R 3V8

The costs of transporting the product to Coleman or an authorized service center for warranty service is the responsibility of the purchaser.

Do not mail products with fuel in tanks, or with disposable propane cylinders. Remove glass globes from lanterns and wrap separately.

**DO NOT RETURN THIS PRODUCT TO THE PLACE OF PURCHASE.**

If you have any questions regarding this warranty please call 1-800-835-3278 or TDD 316-832-8707 in the United States or 1 800 387-6161 in Canada.