



GHF SERIES HEAVY DUTY RANGE MATCHING GAS FRYERS & FRYMATES

MODELS

GHF91G

ML-135503

GHF90G

ML-135504

- NOTICE -

This manual is prepared for the use of trained Vulcan Service Technicians and should not be used by those not properly qualified. If you have attended a Vulcan Service School for this product, you may be qualified to perform all the procedures described in this manual.

This manual is not intended to be all encompassing. If you have not attended a Vulcan Service School for this product, you should read, in it's entirety, the repair procedure you wish to perform to determine if you have the necessary tools, instruments and skills required to perform the procedure. Procedures for which you do not have the necessary tools, instruments and skills should be performed by a trained Vulcan Service Technician.

Reproduction or other use of this Manual, without the express written consent of Vulcan, is prohibited.

For additional information on Vulcan-Hart or to locate an authorized parts and service provider in your area, visit our website at www.vulcanhart.com

TABLE OF CONTENTS

GENERAL	3
Introduction	3
Installation	3
Oil Filtering	3
Operation	3
Cleaning	3
Lighting Pilot	3
Specifications	3
Gas Data	3
Tools	3
Standard	3
REMOVAL AND REPLACEMENT OF PARTS	4
Covers and Panels	4
Door	4
Front Panel	4
Burners	4
Thermostat	5
High Limit	6
Thermopile	6
Pilot Orifice	7
Combination Valve	7
Fry Tank	8
SERVICE PROCEDURES AND ADJUSTMENTS	9
Millivolt Controls Test	9
Thermostat Calibration	9
Calibration Steps	9
Pilot Adjustment	10
Burners, Nozzles and Orifices	10
Burners	10
Nozzles and Orifices	10
Combination Valve Regulator Adjustment	11
ELECTRICAL OPERATION	12
Control System Description	12
System Condition Quick Check Procedures	12
Schematic	13
Component Function	13
TROUBLESHOOTING	14

GENERAL

INTRODUCTION

Models

This service manual was written for:

GHF91G Gas Fryers and GHF90G Gas Frymates.

INSTALLATION

Generally, installations are made by the dealer or contracted by the dealer or owner. Detailed installation instructions are included in the Installation and Operation Manual, which is sent with each fryer.

OIL FILTERING

Filtering instructions are included in the Installation and Operation Manual.

OPERATION

Detailed operation instructions are included with each fryer in the Installation and Operation Manual.

CLEANING

Detailed cleaning procedures are included in the Installation and Operation Manual.

LIGHTING PILOT

1. Turn thermostat OFF.
2. Push combination valve knob in and turn to OFF.
3. Wait 5 minutes for unburned gas to vent.
4. Push combination valve knob in and turn to PILOT.
5. While holding the combination valve knob in, light the pilot with a lit taper. Hold the combination valve knob in for approximately 30 seconds before releasing.

NOTE: If pilot does not remain lit, repeat steps 2 through 5, but allow a longer period of time before releasing the combination valve knob. Adjust pilot flame, if necessary, as outlined under Pilot Adjustment in Service Procedures and Adjustments.

6. Turn combination valve knob to ON.

SPECIFICATIONS

Gas Data

MODEL	No. Tubes	BTU/HR
GHF91G	4	120,000
GHF90G	0	0

TOOLS

Standard

- Hand tools (standard set)
- VOM with AC current tester (any quality VOM with a sensitivity of at least 20,000 ohms per volt can be used)
- Gas test kit
- Temperature tester (thermocouple type)
- Manometer

REMOVAL AND REPLACEMENT OF PARTS

COVERS AND PANELS

WARNING: SHUT OFF THE GAS BEFORE SERVICING.

Door

1. Open door and using a $\frac{5}{16}$ " wrench or ratchet, remove (2) screws securing the top door mounting bracket to the left body side channel.

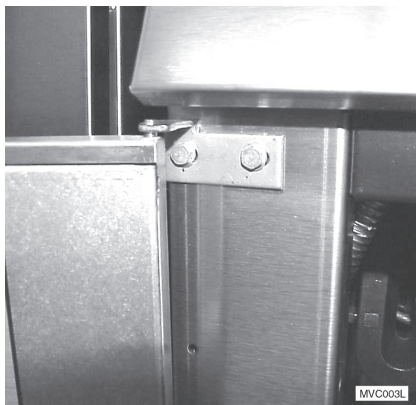

2. Hold door in one hand and lift the door panel assembly off of the bottom hinge.
3. Reverse this procedure to reinstall the door panel.

Front Panel

1. Using a flat head screwdriver, remove (2) screws holding the front panel in place.
2. Remove the panel from the unit.

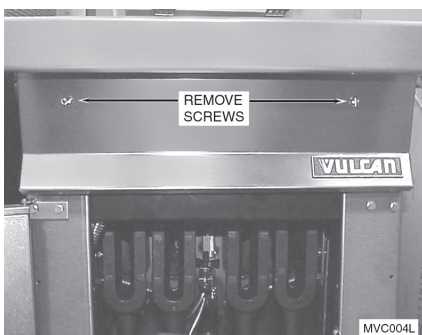

3. Remove heat shield.

BURNERS

WARNING: SHUT OFF THE GAS BEFORE SERVICING.

1. Open door panel.
2. Loosen (Do not remove) the two mounting bolts at the top of each burner.

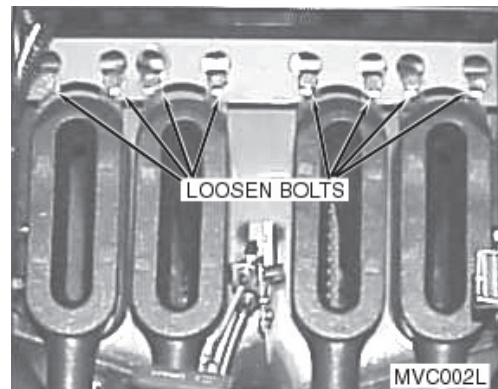

3. Push burner up while pulling the bottom of the burner forward to clear the burner nozzle.

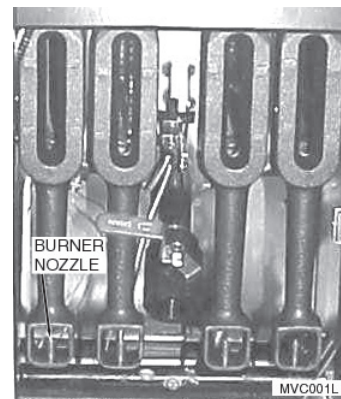

4. Reverse the procedure to install.

THERMOSTAT

WARNING: SHUT OFF THE GAS BEFORE SERVICING.

1. Drain shortening from fry tank.
2. Remove left burner as outlined under Burners.
3. Remove thermostat knob by pulling knob off thermostat shaft.
4. Remove thermostat mounting screws and remove thermostat from mounting bracket.

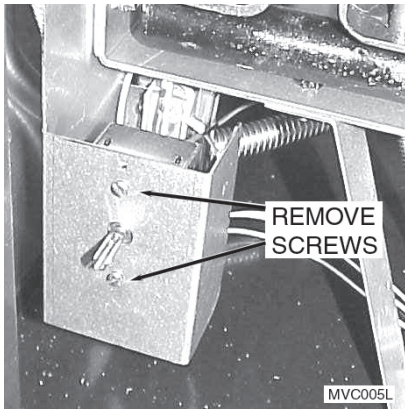

5. Remove wire leads from the rear of the thermostat, noting all connections for reassembly.

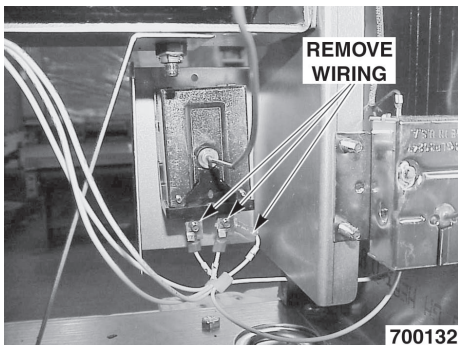

6. Loosen the packing nut and holding nut.

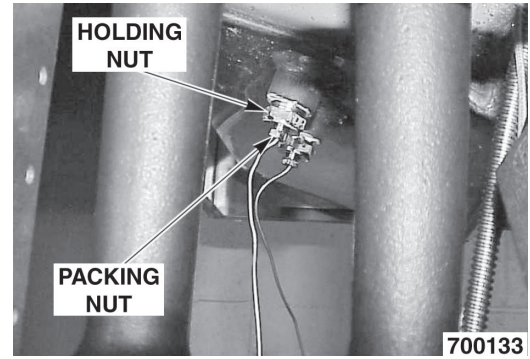

7. Remove the thermostat bulb from the clamp.

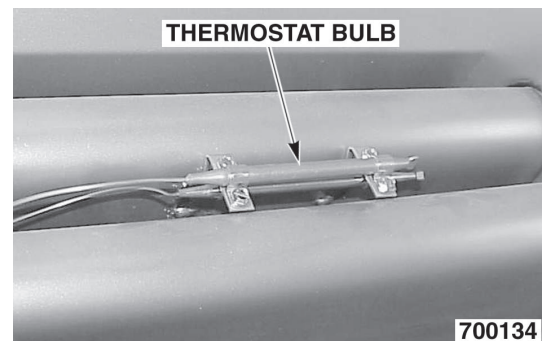

8. Pull the thermostat bulb through the underside of the fry tank and remove the thermostat assembly.
9. Reverse the procedure to install. When installing the new thermostat assembly, do not kink the thermostat capillary. Wrap threads of packing nut with Teflon tape to prevent leakage.

HIGH LIMIT

WARNING: SHUT OFF THE GAS BEFORE SERVICING.

1. Drain shortening from fry tank.
2. Remove wire leads from high limit, noting all connections for reassembly.

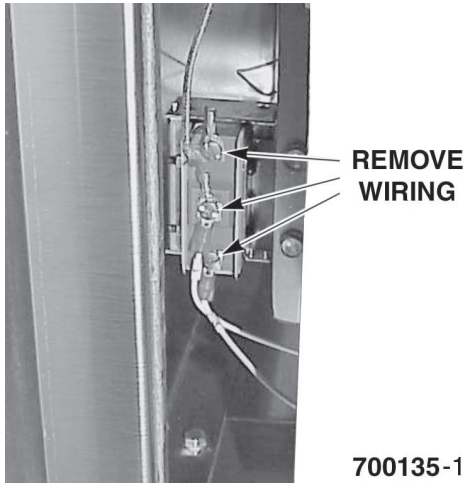

3. Remove high limit from mounting bracket.
4. Remove left burner as outlined under Burners.
5. Loosen the packing nut and the holding nut.

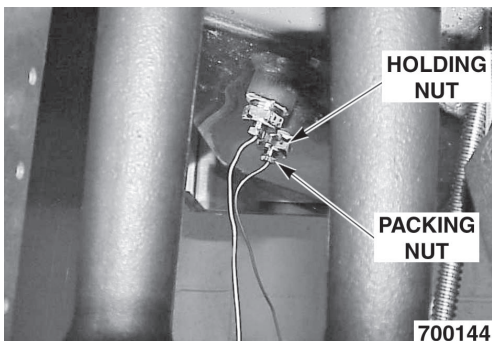

6. Remove the high limit bulb from the clamp.

7. Pull the high limit bulb through the underside of the fry tank and remove the high limit assembly.

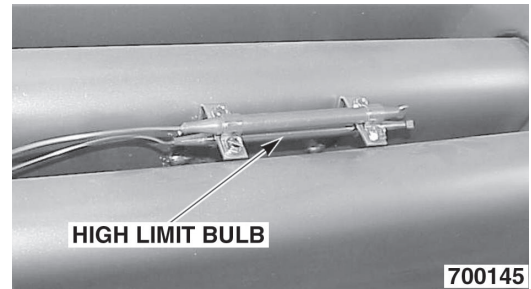

8. Reverse the procedure to install. When installing the new high limit assembly, do not kink the high limit capillary. Wrap threads of packing nut with Teflon tape to prevent leakage.

THERMOPILE

WARNING: SHUT OFF THE GAS BEFORE SERVICING.

WARNING: ALL GAS JOINTS DISTURBED DURING SERVICING MUST BE CHECKED FOR LEAKS. CHECK WITH SOAP AND WATER SOLUTION (BUBBLES). DO NOT USE AN OPEN FLAME.

1. Disconnect thermopile lead wires as outlined under High Limit.
2. Remove (1) 10-24 screw and pull the pilot assembly away from the tank body.
3. Remove (2) side screws to detach the pilot from the holding bracket.

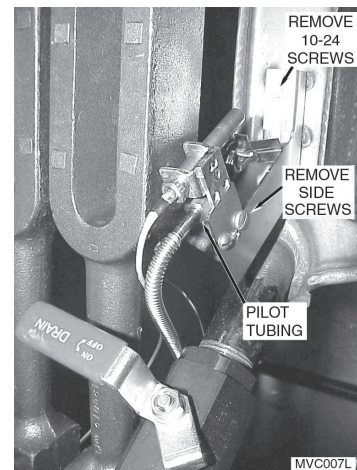

4. Remove pilot tubing from pilot.
5. Remove screws holding pilot bracket.

- Remove thermopile from pilot bracket.

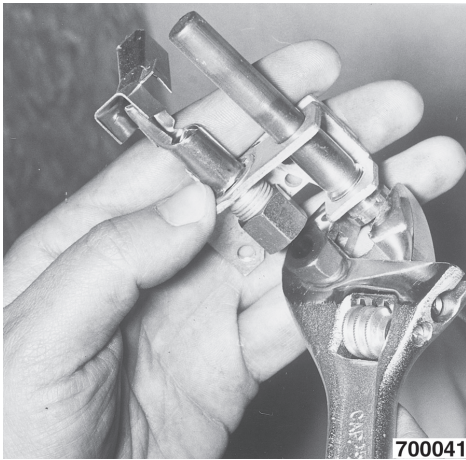

- Reverse procedure to install.

PILOT ORIFICE

WARNING: SHUT OFF THE GAS BEFORE SERVICING.

WARNING: ALL GAS JOINTS DISTURBED DURING SERVICING MUST BE CHECKED FOR LEAKS. CHECK WITH SOAP AND WATER SOLUTION (BUBBLES). DO NOT USE AN OPEN FLAME.

- Remove pilot assembly from fryer as outlined under thermopile.
- Remove hex nut on the bottom of the pilot to expose the orifice.
- Replace orifice and reverse procedure to assemble.

COMBINATION VALVE

WARNING: SHUT OFF THE GAS BEFORE SERVICING.

WARNING: ALL GAS JOINTS DISTURBED DURING SERVICING MUST BE CHECKED FOR LEAKS. CHECK WITH SOAP AND WATER SOLUTION (BUBBLES). DO NOT USE AN OPEN FLAME.

- Disconnect fryer from main gas supply.

- Remove the right hand burners as outlined under Burners (optional).
- Disconnect lead wires from combination valve and mark for reconnecting.
- Disconnect pilot tubing from combination valve.

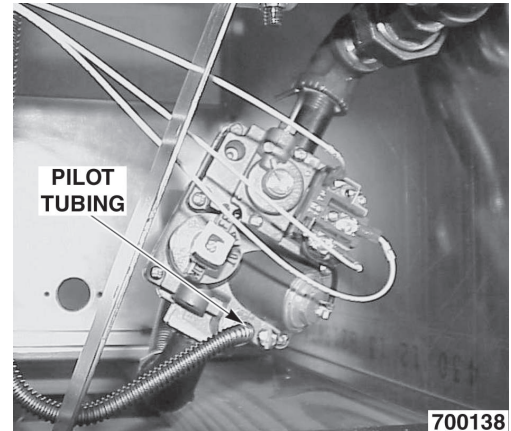

- Disconnect combination valve union (Fig.1) and pressure fitting (Fig. 2).

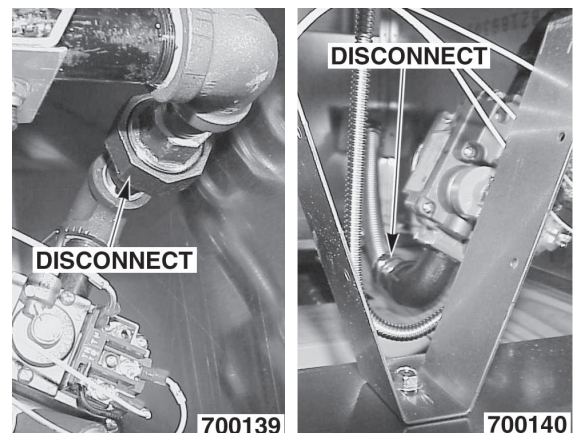

Fig.1

Fig. 2

- Remove the combination valve from the fryer.
- Reverse procedure to install.

FRY TANK

WARNING: SHUT OFF THE GAS BEFORE SERVICING.

WARNING: ALL GAS JOINTS DISTURBED DURING SERVICING MUST BE CHECKED FOR LEAKS. CHECK WITH SOAP AND WATER SOLUTION (BUBBLES). DO NOT USE AN OPEN FLAME.

1. Disconnect fryer from main gas supply.
2. Drain oil from tank.
3. Remove baskets, fryer basket hanger and crumb screen.

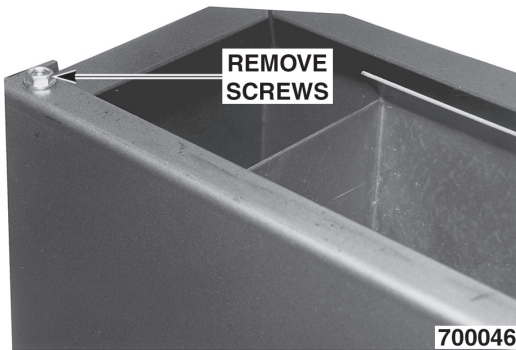

4. Remove screws holding fry tank.
5. Remove burners as outlined under Burners.
6. Remove the manifold bracket from the tank assembly.

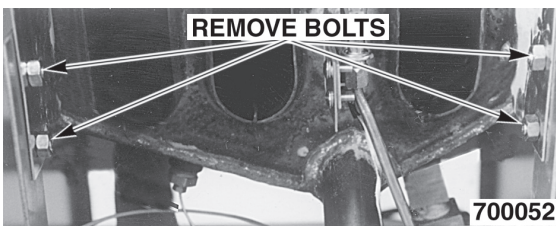

7. Remove thermostat and high limit as outlined under Thermostat and High Limit.

8. Remove screws holding pilot assembly to bracket and remove pilot assembly.

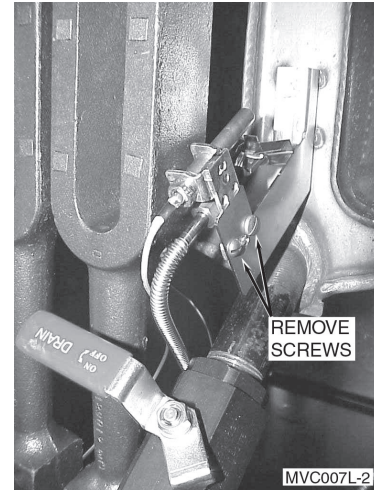

9. Lift the fry tank up and out of cabinet. Carefully place the tank assembly on the floor (this procedure requires two people).
10. Remove the tank ball drain valve.
11. Reverse the procedure to install new tank.

SERVICE PROCEDURES AND ADJUSTMENTS

MILLIVOLT CONTROLS TEST

1. Verify proper gas (natural or propane) is present.
2. Check for correct wiring and secure connections.
3. Verify the pilot flame is adjusted properly as outlined in Pilot Adjustment.
4. If the pilot is not lit, light pilot as outlined under Lighting Pilot. Allow the pilot to burn for 3 to 4 minutes to stabilize.
 - A. If the pilot remains lit, proceed to step 6.
 - B. If the pilot will not remain lit, proceed to step 5.
5. Connect DC voltmeter to terminals TH TP and TP of combination valve. Relight the pilot, hold the combination valve knob in and allow the pilot to burn for 3 to 4 minutes to stabilize.
 - A. If the voltage measures 450 millivolts or greater and the pilot will not stay lit, replace the combination valve.
 - B. If the voltage is less than 450 millivolts, measure the voltage at terminals NO and C of high limit.
 - 1) If the voltage is 500 millivolts or more, replace the high limit.
 - 2) If the voltage is less than 500 millivolts, disconnect the lead wire from terminal TH TP of the combination valve and remeasure voltage at the high limit.
 - a. If the voltage is less than 500 millivolts, replace the thermopile.
 - b. If the voltage is 500 millivolts or more, replace the combination valve.
6. Connect DC voltmeter to terminals TP and TH of combination valve.

7. Turn combination valve to ON. Turn thermostat to a setting higher than the shortening temperature.
 - A. If the voltage measures 150 millivolts or more but the burners do not ignite, replace the combination valve.
 - B. If the voltage is less than 150 millivolts, measure the voltage between terminals NO of the high limit and TP of the combination valve.
 - 1) If the voltage is 200 millivolts or greater, replace the thermostat.
 - 2) If the voltage is less than 200 millivolts, replace the combination valve.

THERMOSTAT CALIBRATION

1. Place temperature tester in the fry tank near the thermostat bulb.
2. Set the thermostat to 300°F and allow the temperature to stabilize.
3. Check the temperature tester reading against the thermostat dial reading. If there is a variance of more than $\pm 20^{\circ}\text{F}$ (280°F to 320°F), calibration is required.

Calibration Steps

1. Remove thermostat knob from shaft.
2. Using a small screwdriver, rotate the setscrew inside the hollow shaft counterclockwise to increase the temperature or clockwise to decrease the temperature ($1/4$ turn equals approximately 18°F).
3. Allow temperature to stabilize and recheck temperature. Repeat until the temperature falls within the limits as stated in step 3 under Thermostat Calibration.
4. Install thermostat knob and set dial to 350°F.

5. Allow temperature to stabilize at new setting and compare temperature tester to dial setting. Recalibrate if the temperature does not fall within the range of 330°F to 370°F.
6. If the temperature does not fall within the limits at both settings, replace the thermostat.

PILOT ADJUSTMENT

1. Light pilot as outlined under Lighting Pilot on page 3.
2. If the flame does not extend beyond the outer edges of the pilot shield $\frac{1}{2}$ ", or extends more than $\frac{1}{2}$ ", an adjustment is necessary.

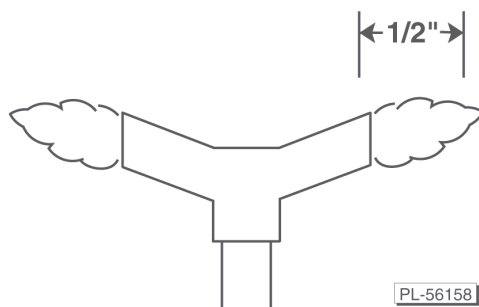

3. Remove the cap covering pilot adjustment screw. Turn the recessed pilot adjustment screw counterclockwise to increase the size of the flame or clockwise to decrease the size of the flame.

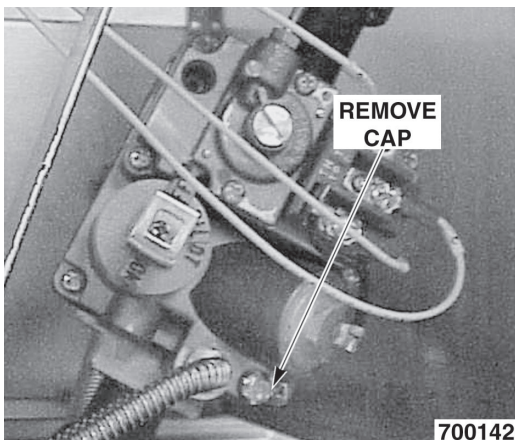

BURNERS, NOZZLES AND ORIFICES

WARNING: SHUT OFF THE GAS BEFORE SERVICING.

Burners

If the burner ports become clogged, the fryer will not operate properly. If the burner is cracked, it must be replaced.

1. Remove burner(s) as outlined under Burners.
2. Check burner(s) for cracks and clogged ports.
3. If the ports are clogged, wash burner(s) in warm, soapy water. If this does not remove obstructions, a #37 drill bit can be used (do not use in an electric drill; hand-turn only).

Nozzles and Orifices

1. Remove the burners as outlined under Burners.
2. Hold the burner nozzle with channel locks and remove the orifice. Check the orifice for obstructions or damage.
3. If the orifice is clogged, wash the orifice in warm, soapy water. If this does not remove obstructions, a #37 drill bit can be used (do not use in an electric drill; hand-turn only).



4. With channel locks, remove the burner nozzle.
5. Reverse procedure to install new burner nozzle and orifice.

COMBINATION VALVE REGULATOR ADJUSTMENT

WARNING: SHUT OFF THE GAS BEFORE SERVICING.

Accurate gas pressure adjustments can only be made with the gas on and the burner lit. If the incoming line pressure to the valve is less than the minimum stated, then the pressure cannot be set correctly.

The combination valve is preadjusted for natural or propane gas as specified on the rating plate. The natural gas rating is 4" W.C., and the propane rating is 10" W.C.

1. Turn the combination valve knob to OFF.

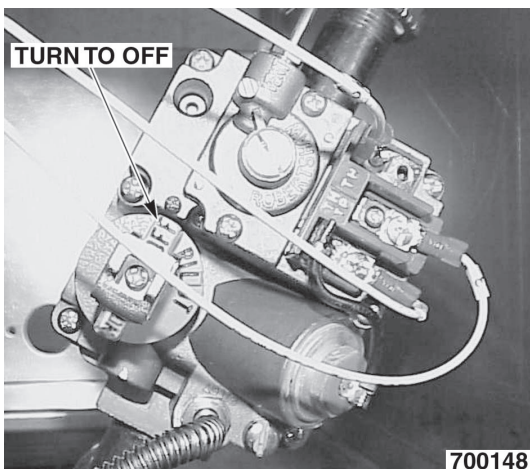

2. Remove the plug from the submanifold and install pressure gauge at this point.

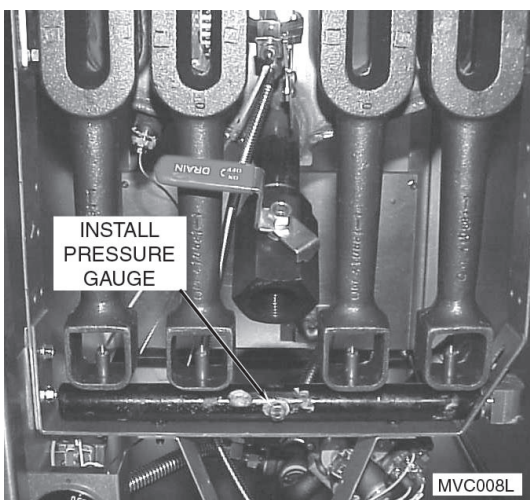

3. Turn on the gas and light the pilot as outlined under Lighting Pilot in General.
4. Turn the combination valve to ON.
5. Set the thermostat so the burners will come on.
6. Read the pressure gauge. The manifold pressure reading should match the pressure rating on the data plate.
 - A. To adjust, remove the cap covering the manifold pressure adjustment screw. Turn the recessed manifold pressure adjustment screw counterclockwise to decrease pressure or clockwise to increase pressure.

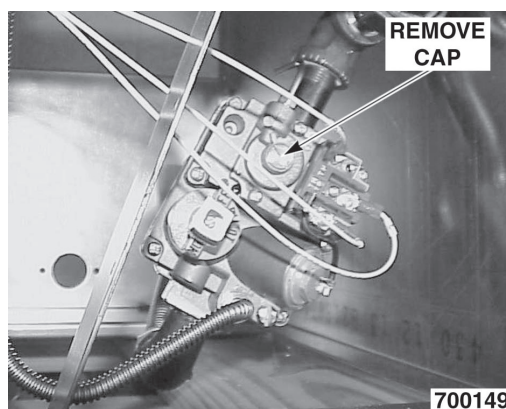

7. Install the cap and check for proper operation.

ELECTRICAL OPERATION

CONTROL SYSTEM DESCRIPTION

1. The thermopile (TP) provides the total control voltage for this system.
 - A. One side of the thermopile is connected to the common (C) of the high limit (HL).
 - B. The other side of the thermopile is connected to the normally open (NO) contacts of the high limit.
 - C. The common of the high limit (below the high limit trip temp.) is connected through the normally closed (NC) contacts of the high limit, through wire 3 to the combination valve pilot connection common.
 - D. The other side of the pilot valve is connected through wire 4 to wire 1 to the high limit normally open contacts which hold the pilot valve open.
 - 1) If the high limit trips, connection is made from the common to the normally open contacts, turning off pilot valve voltage. The gas valve closes.
2. Thermostat Control.
 - A. One side of the millivolt supply is connected through the high limit system, as described above, to the thermostat common (wire 3) of the combination valve.
 - B. The other side of the thermopile is connected from the normally open contacts of the high limit to the thermostat through wire 1.
 - C. When the thermostat calls for heat (closed circuit) power from the thermopile is then connected to the other combination valve thermostat connection through wire 2.
 - D. If the high limit trips, the thermopile is connected across zero ohms, the output voltage of the thermopile drops to 0.0 millivolts, and the thermostat coil of the combination valve drops out, shutting the thermostat valve.

3. Total Shutdown.
 - A. When the high limit trips, 0.0 millivolts will read across both coils of the combination valve, causing both valves to close.
 - B. Pilot relight cannot be accomplished until oil cools sufficiently to allow high limit to close.
 - C. If any wire in the system is cut or broken, the system will shut down.

SYSTEM CONDITION QUICK CHECK PROCEDURES

1. Use the Pilot Lighting procedure and check millivolts (mV) at wires 3 and 4.
 - A. If the pilot lights, then pilot combination and high limit are good.
 - B. If the pilot will not stay lit, check high limit and open the thermopile circuit. It should read 300 mV; if there are \emptyset volts, check high limit. If the high limit is good, replace combination valve.
 - C. Check for voltage at disconnected thermopile. It should read 300 mV; if there are \emptyset volts, replace thermopile. Check high limit. If the high limit is good, replace combination valve.
2. Turn on thermostat; burners should light.
 - A. If the burner does not light, check the following:
 - 1) Voltage at combination valve at wires 2 and 4.
 - 2) If correct voltage is present, then check combination valve.
 - 3) If there are \emptyset volts, check voltage between wire 3 of combination valve and wire 1 of thermostat. If correct voltage is present, then check resistance of thermostat and wire 32. If there is no voltage, check resistance of wire 1 to normally open contacts of high limit.

SCHEMATIC

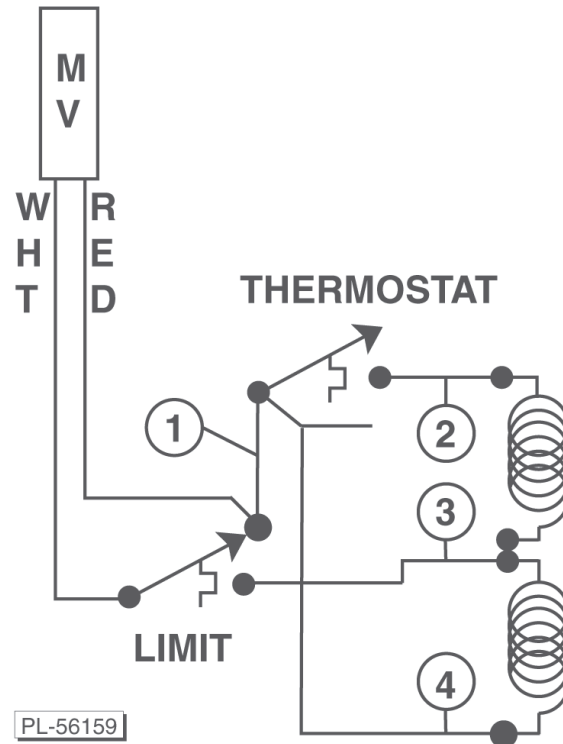

COMPONENT FUNCTION

Thermostat - Millivolt type with capillary bulb, single-throw break on temperature rise. Temperature range of 200°F to 400°F.

Thermopile - Millivolt control with 24" capillary. Rated to generate 500 millivolts.

Combination Valve - Regulates gas flow to burner and pilot. Provides pilot safety.

Hi-Limit - Prevents overheating of fryer in the event of thermostat failure. Opens at 450°F and automatically resets at 415°F.

TROUBLESHOOTING

SYMPTOM

POSSIBLE CAUSE

-
- | | |
|---|---|
| 1. The temperature of the shortening drops, or excessive recovery time is required. | A. Insufficient gas supply to unit.
B. Ventilating system pulling heat out of heat exchanger and flue box.
C. Overloading fryer capacity. |
| 2. Pilot won't stay lit. Fryer shut off. | A. Malfunctioning thermopile or loose/dirty connection in thermopile.
B. Malfunctioning shutoff valve.
C. Pilot burner orifice and air openings need cleaning. |
| 3. Rapid shortening breakdown, crumbs and specks in frying compound. | A. Excessive temperature settings (over 375°F).
B. Shortening not being filtered regularly.
C. Incorrect preparation of breaded food. <ul style="list-style-type: none">• Do not use salt.• Allow breading time to adhere to food.• Do not allow loose flour to fall into shortening from hands. D. Do not add strainings or drippings from meat fats to shortening.
E. Use correct shortening and follow temperature recommendations.
F. Take out 10% to 15% of the shortening.
G. Check thermostat settings with thermometer periodically. |

TROUBLESHOOTING

SYMPTOM

POSSIBLE CAUSE

4. Leaking tank.

- A. Foam-over by depleted shortening permits oil to drip from the tank surface, giving the appearance of leaking.
- B. Careless draining procedures. Gas valve should be in the PILOT or OFF position before draining oil. Burners heating an empty tank will damage tank joints.
- C. Carbon buildup causes rapid attack on tank by promoting acid formulation.

5. Pilot burner flames adjusted properly, but fluctuate to very low and blow out easily.

- A. Check gas pressure at submanifold fitting on fryer when fryer is in operation. Check all other equipment on the same gas line in operation.
- B. Pressure at submanifold (pipe on which burners are mounted) should not be less than 4.0" W.C. (natural and mixed gas) or 10" W.C. for propane gas.

NOTES