

# ***Thermador***<sup>®</sup>

## **Care and Use Manual**



**Model PGR304**



**Model PGR364GL**  
Low Back Model LB36R



**Model PGR484GG**  
Low Back Model LB48R

### **Thermador Professional<sup>®</sup> Range**

FOR RESIDENTIAL USE ONLY

All Gas Models PGR30, PGR36, PGR48

**LE MANUEL DE SOIN ET D'UTILISATION  
EN ANGLAIS AVEC ADVERTISSEMENTS EN FRANÇAIS**

## ***A SPECIAL MESSAGE TO OUR CUSTOMERS***

Thank you for selecting the Thermador PROFESSIONAL® Range. We recommend that you take time to read this entire booklet before using your new appliance for the first time.

The booklet contains suggestions we believe will be helpful as well as directions for using all the features of this range. Keep it in a handy place, as it has the answers to questions that may occur when you start to cook.

Let us know if we can help you. When you write, please include the model and serial number of your range.

Sincerely,

**Thermador Test Kitchen Consumer Scientists**



### **WARNING:**

If the information in this manual is not followed exactly, a fire or explosion may result causing property damage, personal injury or death.

### **FOR YOUR SAFETY**

- ✓ **Do not store or use gasoline or other flammable vapors and liquids in the vicinity of this or any other appliance.**

### **AVERTISSEMENT**

- ✓ **Ne pas entreposer ni utiliser de l'essence ni d'autres vapeurs ou liquides inflammables dans le voisinage de l'appareil, ni de tout autre appareil.**

### **WHAT TO DO IF YOU SMELL GAS**

- Do not try to light any appliance.
- Do not touch any electrical switch; do not use any phone in your building.
- Immediately call your gas supplier from a neighbor's phone.
- Follow the gas supplier's instruction.
- If you cannot reach your gas supplier, call the fire department.
- Installation and service must be performed by a qualified installer, service agency or the gas supplier.

### **CE QUI FAIRE SI VOUS SENTEZ LE GAZ**

- Ne pas essayer d'allumer aucun appareil.
- Ne pas toucher aucun interrupteur électrique; ne pas utiliser aucun téléphone dans votre bâtiment.
- Appeler immédiatement votre fournisseur de gaz du téléphone d'un voisin. Suivre l'instruction du fournisseur de gaz.
- Si vous ne pouvez pas contacter votre fournisseur, téléphone le service des incendies.
- L'installation et le service doivent être exécutés par un installateur qualifié, une agence de service ou le fournisseur de gaz.

# INTRODUCTION

## TABLE OF CONTENTS

Introduction .....	1
Gas Type Verification .....	1
Care and Use Manual Conventions.....	2
<b>Section One: General Safety Instructions</b>	
Safety .....	3 – 4
Precautions.....	5 – 6
<b>Section Two: Before You Begin</b>	
Before Using Your Range for the First Time.....	7
<b>Section Three: Description</b>	
Model & Parts Identification – PGR484GG .....	8
Model & Parts Identification – PGR366 .....	9
Model & Parts Identification – PGR304 .....	10
Guide to Knob Identification and Location .....	11
<b>Section Four: Using the Cooktop</b>	
Using the Cooktop.....	12 – 13
Flame Setting Guidelines.....	14
Proper Cookware .....	15 – 16
Surface Burner Cooking Chart .....	17 – 18
Using the Grill .....	19 – 21
Grill Cooking Chart.....	22 – 23
About the Griddle.....	24
Griddle Cooking Chart .....	24
<b>Section Five: Using the Oven</b>	
Bake .....	25
Convection•Bake .....	26
Setting Bake/Convection•Bake .....	27
Other Uses of Bake .....	28
Baking Chart .....	29
Broil .....	30
Setting Broil and Convection Broil .....	31
Broiling and Roasting Chart .....	32
<b>Section Six: Care and Maintenance</b>	
Self-Cleaning the Oven.....	33 – 34
Range Cleaning Chart.....	35 – 40
<b>Section Seven: Before Calling For Service</b>	
Do-It-Yourself Maintenance.....	41
Before Calling For Service.....	42
Data Rating Plate .....	42
Warranty .....	43

## INTRODUCTION

The Thermador Professional® Ranges are free-standing units available in a number of configurations. All models feature a gas cooking surface with a professional size, Gas convection, self-cleaning oven with broil capability.

## GAS TYPE VERIFICATION

Verify the type of gas supplied to the location. Ensure that the appliance is connected to the type of gas for which it is certified. Models come from the factory certified for use with natural gas or with propane (LP) gas. Make certain your range and gas type are the same. Refer to the product rating label which can be located as indicated on Page 42.



### CAUTION:

When connecting the unit to propane gas, make certain the propane gas tank is equipped with its own high-pressure regulator in addition to the pressure regulator supplied with the range. **The maximum gas pressure to this appliance must not exceed 14.0 inches water column (34.9 millibars) from the propane gas tank to the pressure regulator.**

### IMPORTANT

All ranges must be installed with a backguard. The PGR 304 comes with a low back. For all other models, one of three available backguards must be ordered separately and installed at the back of the range. The three backguard choices include a Low Back, High Back Shelf, or Island Trim. Before using the range, insure that it is equipped with a proper backguard. Refer to the Installation Instructions accompanying this appliance for more information.

# Introduction

This manual contains important Care and Use information for all Thermador Professional® Ranges. When using this manual, it is critical that you know the model number of your range, as some information will be unique to each Range. The model number may be found on the rating plate located on the range as identified on Page 42 of this manual. The charts on the following pages summarize the various range models and identify the features of each range.

## **PGR Ranges, featuring a Gas Cooking Surface with Self-Cleaning Gas Ovens with Gas Broiler.**

- All Gas PGR304** .....All Gas, 30" wide Range with Four Gas Cooktop Burners and self-cleaning Gas Oven
- All Gas PGR364GD** .....All Gas, 36" wide Range with Four Gas Cooktop Burners, Griddle and self-cleaning Gas Oven
- All Gas PGR364GL** .....All Gas, 36" wide Range with Four Gas Cooktop Burners, Grill and self-cleaning Gas Oven
- All Gas PGR366** .....All Gas, 36" wide Range with Six Gas Cooktop Burners and self-cleaning Gas Oven
- All Gas PGR486GD** .....All Gas, 48" wide Range with Six Gas Cooktop Burners, Griddle, large self-cleaning Gas Oven and one auxiliary oven.
- All Gas PGR486GL** .....All Gas, 48" wide Range with Six Gas Cooktop Burners, Grill, large self-cleaning Gas Oven and one auxiliary oven.
- All Gas PGR484GG** .....All Gas, 48" wide Range with Four Gas Cooktop Burners, Grill, Griddle, large self-cleaning Gas Oven and one auxiliary oven.

## SECTION ONE: GENERAL SAFETY INSTRUCTIONS

# SAFETY

## GAS AND ELECTRICAL REQUIREMENTS AND GROUNDING INSTRUCTIONS

### PLEASE READ CAREFULLY

#### Gas Models:

PGR304  
120 volts, 60 Hz.,  
10 Amp electrical circuit required.

#### Gas Models:

PGR364GD, PGR364GL,  
PGR366  
120 volts, 60 Hz.,  
10 Amp electrical circuit required.

#### Gas Models:

PGR486GD, PGR486GL,  
PGR484GG  
120 volts, 60 Hz.,  
10 Amp electrical circuit required.

**FOR PERSONAL SAFETY,  
THIS APPLIANCE MUST  
BE CONNECTED TO A  
PROPERLY GROUNDED  
AND POLARIZED ELEC-  
TRICAL POWER SUPPLY.**

### CAUTION

Accessible parts may become hot when the grill is in use. Young children must be kept away.

See Installation Instructions for electrical requirements and grounding instructions.

It is the personal responsibility and obligation of you, the user, to have this appliance connected to the electrical power supply in accordance with the National Electrical Code and/or applicable local codes and ordinances by a qualified electrician.



### CAUTION - ALL MODELS

#### IN CASE OF AN ELECTRICAL FAILURE

If for any reason a gas control knob is turned ON and there is no electrical power to operate the electronic igniters on the cooktop burners, **turn OFF the gas control knob and wait 5 minutes** for the gas to dissipate before lighting the cooktop burner manually.

To light the cooktop burners manually, carefully hold a lighted match to the burner ports and turn the gas control knob to HI. During a power failure you can use the cooktop burners, but each must be lit with a match.

**DO NOT** attempt to light the two left burners manually. These burners are equipped with the ExtraLow® feature and cannot be lit manually.

ALWAYS DISCONNECT THE ELECTRICAL PLUG FROM THE WALL RECEPTACLE BEFORE SERVICING THIS UNIT.

It is recommended that a dedicated circuit servicing this appliance be provided.

The use of gas cooking appliances results in the production of heat and moisture.

#### TESTED IN ACCORDANCE WITH:

- ANSI Z21.1-2000 for Household Gas Appliances
- UL858 14th Edition for Household Gas Ranges
- CAN/CSA-22.2 No. 61-M89 for Household Cooking Ranges
- CAN/CGA 1.1-M81 Domestic Gas Ranges

Check your local building codes for the proper method of installation. In the absence of local codes, this unit should be installed in accordance with the National Fuel Gas Code No. Z223.1 Current Issue and the National Electrical Code ANSI/NFPA No. 70 Current Issue or the Can - B149 Installation Codes for Gas Burning Appliances and C22.1 Canadian Electrical Code Part I.

## SAVE THESE INSTRUCTIONS

## PRECAUTIONS

# SAFETY PRACTICES TO AVOID PERSONAL INJURY

When properly cared for, your new Thermador PROFESSIONAL® Range has been designed to be a safe, reliable appliance. However, use extreme care when using this restaurant caliber range as this type of appliance provides intense heat and can increase the accident potential. When using kitchen appliances, basic safety precautions must be followed, including the following:

**Read this Care and Use Manual carefully before using your new range** to reduce the risk of fire, electrical shock, or injury to persons.

**Insure proper installation and servicing.** Follow the installation instructions provided with this product. Have the range installed and grounded by a qualified technician.

**Have the installer show you where the gas supply shut-off valve is located** so that you know how and where to turn off the gas to the range.

**If you smell gas**, your installer has not done a proper job of checking for leaks. If the connections are not perfectly tight, you can have a small leak and therefore a faint gas smell. Finding a gas leak is not a “do-it-yourself” procedure. Some leaks can only be found with the burner control in the ON position and this must be done by a qualified service technician. See Inside Front Cover regarding gas leaks.

In the event a burner goes out and **gas escapes**, open a window or a door. Do not attempt to use the cooktop until the gas has had time to dissipate. **Wait at least 5 minutes before using the range.**

**Do not repair or replace any part of the appliance** unless specifically recommended in this manual. All other servicing should be referred to a qualified technician.

**Children should not be left alone or unattended in an area where appliances are in use.** They should never be allowed to sit or stand on any part of the appliance.

**CAUTION: Do not store items of interest to children above the range or at the back of it.** If children should climb onto the appliance to reach these items, they could be seriously injured.

**Never use any part of the cooktop or oven for storage. Flammable materials can catch fire and plastic items may melt or ignite.**

**Do not hang articles from any part of the appliance or place anything against the oven.** Some fabrics are quite flammable and may catch on fire.

If the range is near a window, **be certain the curtains do not blow over or near the cooktop burners;** they could catch on fire.

**DO NOT USE WATER ON GREASE FIRES.** Turn appliance off and smother fire with baking soda or use a dry chemical or foam-type extinguisher.

**Never let clothing, potholders, or other flammable materials come in contact with or too close to any element, burner or burner grate** until it has cooled. Fabric may ignite and result in personal injury.

**Use only dry potholders:** moist or damp potholders on hot surfaces may cause burns from steam. Do not use a towel or other bulky cloth in place of potholders. Do not let potholders touch hot elements, hot burners, or burner grates.

**For personal safety, wear proper apparel.** Loose fitting garments or hanging sleeves should never be worn while using this appliance. Some synthetic fabrics are highly flammable and should not be worn while cooking.

**Do not use aluminum foil to line any part of the oven or cooktop.** Use of a foil liner could result in a shock or fire hazard, or the obstruction of the flow of combustion and ventilation air. Foil is an excellent heat insulator and heat will be trapped beneath it. This will upset the cooking performance and can damage the finish of the oven or the cooktop.



### WARNING



**TO REDUCE THE RISK OF TIPPING OF THE APPLIANCE, IT MUST BE SECURED BY A PROPERLY INSTALLED ANTI-TIP DEVICE. VERIFY THAT THE ANTI-TIP DEVICE IS ENGAGED PER INSTALLATION INSTRUCTIONS. (NOTE: ANTI-TIP DEVICE IS REQUIRED ON ALL 30" AND 36" RANGES)**

## PRECAUTIONS

**Warning: The appliance is for cooking.** Based on safety considerations, never use the oven or cooktop to warm or heat a room. Also, such use can damage the cooktop or oven parts.

When using the cooktop: **DO NOT TOUCH THE BURNER GRATES OR THE IMMEDIATE SURROUNDING AREA.** Areas adjacent to the burners may become hot enough to cause burns.

**Never leave the cooktop unattended** when using high flame settings. Boil overs cause smoking and greasy spillovers that may ignite. More importantly, if the burner flames are smothered, unburned gas will escape into the room. See Inside Front Cover regarding gas leaks.

**Only certain types of glass, heat-proof glass-ceramic, ceramic, earthenware, or other glazed utensils are suitable for cooktop use.** This type of utensil may break with sudden temperature changes. Use only on low or medium heat settings according to the utensil manufacturer's directions.

**Do not heat unopened food containers;** a buildup of pressure may cause the container to burst.

During cooking, **set the burner control so that the flame heats only the bottom of the pan and does not extend beyond the bottom of the pan.**

Avoid using high flame setting with a **pan larger than the grate** or with one that spans more than one burner, such as a griddle, for prolonged periods of time. This can result in poor combustion that generates harmful by-products.

**Use caution to insure that drafts like those from forced air vents or fans do not blow flammable material toward the flames or push the flames so that they extend beyond the edges of the pot.**

**Always use utensils that have flat bottoms, large enough to cover the burner.** The use of undersized utensils could expose a portion of the flame and may result in ignition of clothing.

To minimize burns, ignition of flammable materials and unintentional spillovers, **position handles of utensils inward** so they do not extend over adjacent work areas, cooking areas, or the edge of the cooktop.

**Hold the handle of the pan** to prevent movement of the utensil when stirring or turning food.

DO NOT use pots or pans on the grill section.

**Do not use the grill for cooking excessively fatty meats or products which promote flare-ups.**

The optional **cutting board accessory must be removed** before operating the griddle beneath or burners adjacent to it.

**GREASE IS FLAMMABLE.** Let hot grease cool before attempting to handle it. Avoid letting grease deposits collect. Clean after each use.

For proper lighting and performance of the burners, **keep the igniter ports clean.** It is necessary to clean these when there is a boil over or when the burner does not light even though the electronic igniters click. See Page 38.



### WARNING

After a spill or boil over, turn off the burner and clean around the burner and burner port. After cleaning, check for proper operation.

### Clean the cooktop with caution.

Avoid steam burns; do not use a wet sponge or cloth to clean the cooktop while it is hot. Some cleaners produce noxious fumes if applied to a hot surface. Follow directions provided by the cleaner manufacturer.

Be sure all cooktop controls are turned off and the cooktop is cool before using any type of aerosol cleaner on or around the cooktop. The chemical that produces the spraying action could, in the presence of heat, ignite or cause metal parts to corrode.

When using the oven: **DO NOT TOUCH THE INFRARED BURNERS, THE INTERIOR SURFACES OF THE OVEN OR THE EXTERIOR AREA IMMEDIATELY SURROUNDING THE DOOR.**

Interior oven surfaces become hot enough to cause burns. The heat deflector, which deflects heat away from the cooktop and the trim on the top and sides of the oven door, will also be hot when the oven is in use.

**Place oven racks in desired position while oven is cool.** If a rack must be moved while the oven is hot, do not let the potholders contact the infrared burner.

**Use care when opening the oven door;** let hot air or steam escape before removing or replacing foods.

**Before self-cleaning the oven,** remove the broiler pan, oven racks and any other utensils, and excess spillage.

## SECTION ONE: GENERAL SAFETY INSTRUCTIONS

# PRECAUTIONS

**Do not clean, rub, damage, move or remove the door gasket.** It is essential for a good seal during baking and while self-cleaning the oven.

**Protect the self-cleaning feature.** Clean only those parts indicated in this booklet. Do not use commercial oven cleaners or oven liner protective coatings of any kind in or around the large self-cleaning oven.

**DO NOT obstruct the flow of combustion or ventilation air.**

For safety reasons and to avoid equipment damage, never sit, stand, or lean on the oven door.

**Service should only be done by**

**authorized Technicians.** Technicians must disconnect the power supply before servicing this unit.

**Listen to be sure the cooling blower runs** whenever the oven controls are set to broil or self-clean. If the fan does not operate, do not use the oven. Call an authorized service center for service.

**Clean the ventilator hood and filters above the range frequently** so grease from cooking vapors does not accumulate on them.

• **In case of fire or when intentionally “flaming” liquor or other spirits on the cooktop, follow hood manufacturer’s instructions.**

**California Proposition 65 - Warning:** The burning of gas cooking fuel and the elimination of soil during self-cleaning generate some by-products which are on the list of substances which are known by the State of California to cause cancer or reproductive harm. California law requires businesses to warn customers of potential exposure to such substances. To minimize exposure to these substances, always operate this unit according to the instructions contained in this booklet and provide good ventilation to the room when cooking with gas, during and immediately after self-cleaning the oven.

**BEFORE USING YOUR RANGE FOR THE FIRST TIME, CHECK THAT YOU HAVE THESE ITEMS:**

DESCRIPTION	PGR 304	PGR 364 GD	PGR 364 GL	PGR 366	PGR 484 GG	PGR 486 GD	PGR 486 GL
Oven Racks Large Oven	3	3	3	3	3	3	3
Oven Racks 12-inch Oven					2	2	2
Two-Piece Broil Pan	1	1	1	1	2‡	2‡	2‡
Star Burner Caps	4	4	4	6	4	6	6
Burner Grates	2	2	2	3	2	3	3
Control Knobs	5	6	6	7	8	9	9
Cast Iron Grill Grate			1		1		1
Stainless Steel Radiant			1		1		1
Coated Titanium-Surface Griddle		1			1	1	
Product Registration Card	1	1	1	1	1	1	1
Backguard	1	*	*	*	*	*	*
Installation Instructions	1	1	1	1	1	1	1
Use and Care Manual	1	1	1	1	1	1	1

\*Backguard must be ordered and shipped separately. It is not included with the range shipment. ‡The aluminum broil pan is for the Secondary Oven; the porcelain & chrome broil pan is for the Main Oven.



# Before Using Your Range for the First Time

**Remove all packaging materials and temporary labels from oven and cooktop.**

1. Check that you have the items listed on Page 6.
2. **Record the Model and Serial number on Page 42. See "Data Rating Plate."** These may be used for any future contacts with your servicer or the factory. Enter this information on the Product Registration Card included with this product then mail it to the indicated address.
3. **Optional Accessories.** Grill Cover, Chopping Board, Griddle Cover and other accessories are available from your Thermador Dealer. Contact the Thermador Parts Department toll-free at 800/735-4327 for more information.
4. **Position the racks correctly in the oven.**

The correct rack position depends on the recipe and the cooking mode. **The rack positions are numbered from the bottom of the oven, like an elevator.** Rack position 3 is the most frequently used position. Place rack(s) in the proper position before turning on the oven.

**Insert** the racks as follows:

- a. Hold the rack with the back rail in the up position towards the rear of the oven. Slip it into the oven so the rack slides are between the rack and the rack guides.
- b. Tip the front of the rack up slightly as it slides into the oven so that the safety stops clear the rack slides. The safety stops on the back of the rack will keep it from sliding out of the oven when it is pulled forward.

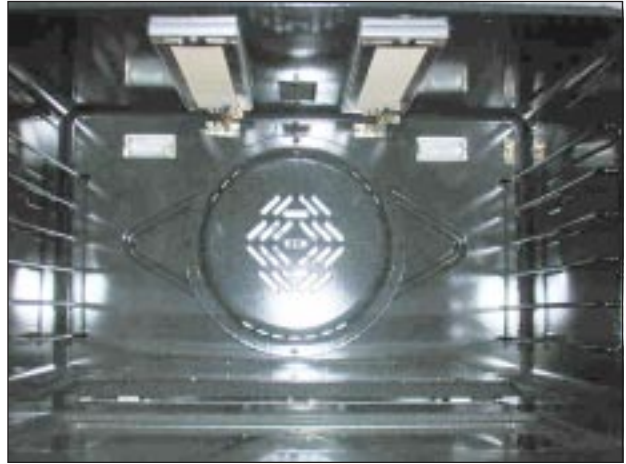

## **CAUTION**

**Aluminum foil should never be used to cover the oven racks or to line the oven. It may cause damage to the oven. Do not remove the infrared burner in the gas oven.**

**BEFORE BAKING OR BROILING**, the oven and broiler should be turned on to burn off the manufacturing oils. Turn the oven on to 450°F (230°C) for 20 to 30 minutes; then turn the broiler to "Broil" for same length of time. You may wish to turn on the ventilator above your range during this time.

Please read Page 40 in Section 6: Care and Maintenance **before** cleaning the oven racks.

# Model and Parts Identification

Gas Model PGR484GG - Shown Has a grill, a griddle and four burners, two ExtraLow® and two standard.  
 Model PGR486GD – Has a griddle and six burners, two ExtraLow® and four standard.  
 Model PGR486GL – Has a grill and six burners, two ExtraLow® and four standard.

## Key for PGR48 Models

1. 22" High Shelf Backguard, 12" Low Back, or Island Trim (Backguard ordered separately)
2. Burner Grates & Burners
3. Grill
4. Griddle
5. Control Knobs, ExtraLow® Burners (2)
6. Control Knobs, Standard Burners (4)
7. Oven Controls
8. Oven Light Switch
9. Oven Door
10. Viewing Window
11. Auxiliary Oven (2 racks included)
12. Kick Panel (Product Rating Label Located Behind Kick Panel)
13. Range Feet (4)

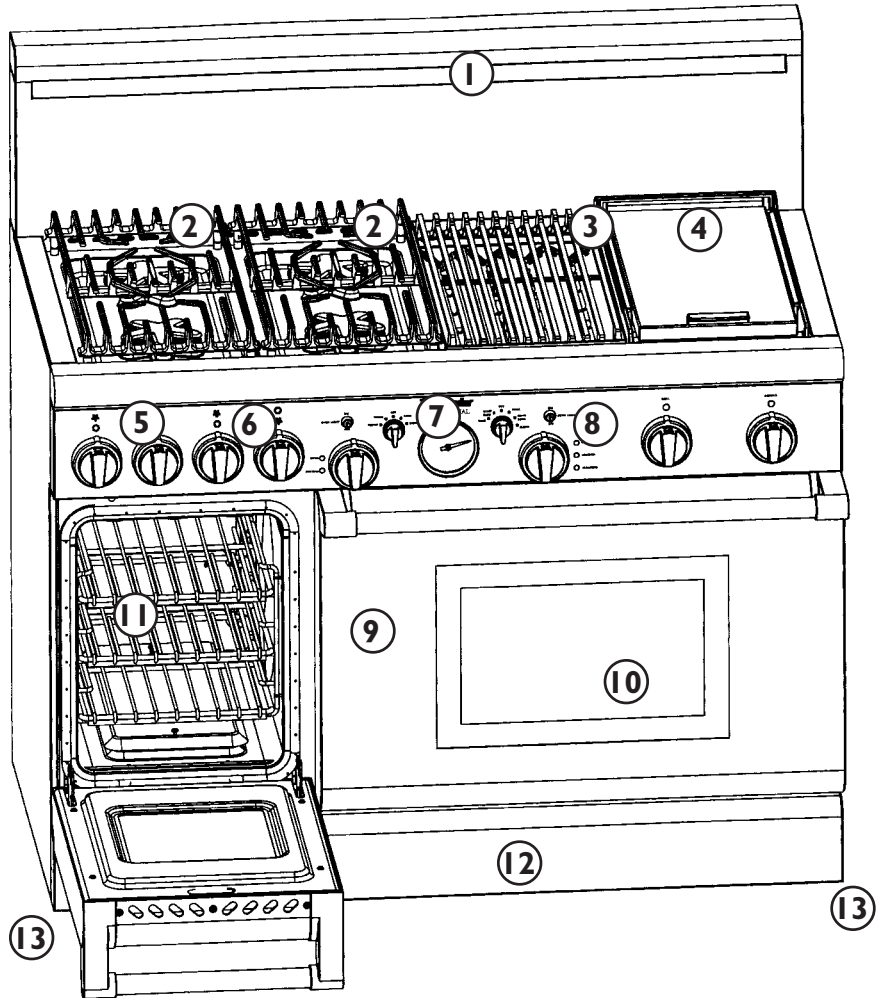

**⚠ WARNING:**  
 To provide proper ventilation, do NOT remove range feet.

## Gas Oven Interior

14. Oven Interior Lights
15. Broil Element
16. Oven Thermostat
17. Rack Guides
18. Oven Rack (3 included, not shown)
19. Bake Element (hidden)
20. Convection Fan Cover

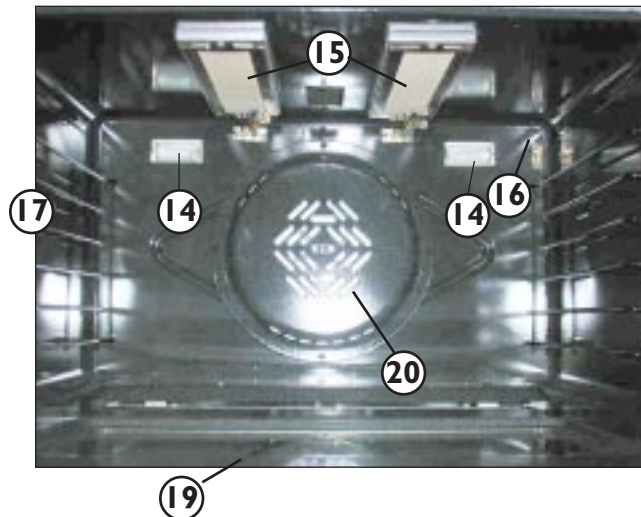

## SECTION THREE: DESCRIPTION

Gas Model PGR366 - Shown

Model PGR364GD – Has a center griddle and four burners, two ExtraLow® and two standard.

Model PGR364GL – Has a center grill and four burners, two ExtraLow® and two standard.

### Key for PGR Models

1. 22" High Shelf Backguard, 12" Low Back, or Island Trim (Backguard ordered separately)
2. Burner Grates & Burners
3. Control Knobs, ExtraLow® Burners (2)
4. Control Knobs, Standard Burners (4)
5. Oven Controls
6. Oven Light Switch
7. Oven Door
8. Viewing Window
9. Kick Panel (Product Rating Label Located Behind Kick Panel)
10. Range Feet (4)

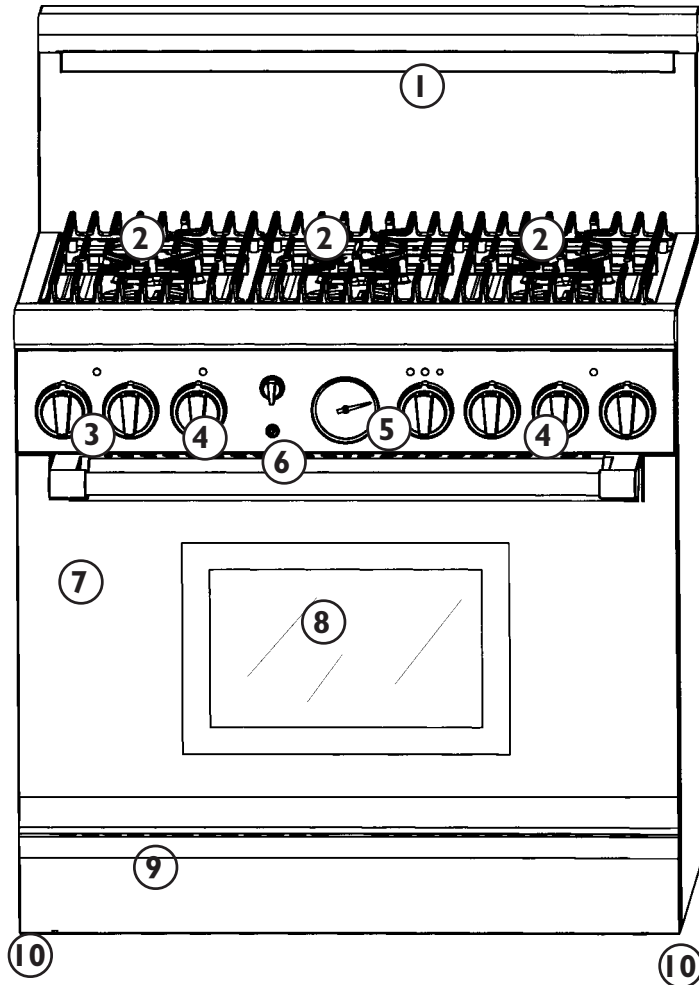

### **WARNING:**

To provide proper ventilation, do NOT remove range feet.

**Gas Oven Interior,**  
*Please see Page 8*

# Model and Parts Identification

Gas Model PGR304 - Shown

## Key for PGR304 Models

1. 9" Low Back or Island Trim  
(Island Trim ordered separately)
2. Burner Grates & Burners
3. Control Knobs, ExtraLow® Burners (2)
4. Control Knobs, Standard Burners (2)
5. Oven Controls
6. Oven Light Switch
7. Oven Door
8. Viewing Window
9. Kick Panel (Product Rating Label  
Located Behind Kick Panel)
10. Range Feet (4)

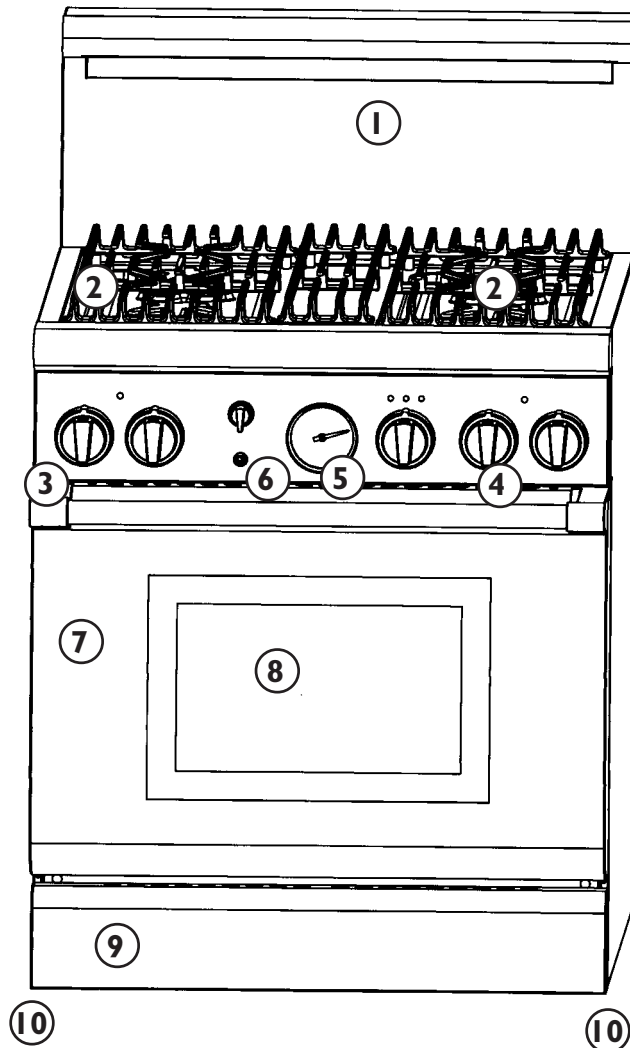

### **WARNING:**

To provide proper ventilation,  
do NOT remove range feet.

**Gas Oven Interior,**  
*Please see Page 8*

# Guide to Knob Identification and Location

Locate each knob type by the corresponding number on the diagrams. Actual knobs are not numbered.

1. **Simmer Knob**  
OFF HI-LO-XLO
2. **Standard Knob**  
OFF HI LO
3. **Grill Knob**  
OFF-LITE-HI-LO
4. **Griddle Knob**  
OFF 150 200 250 300  
350 400 450 500
5. **Auxiliary Oven Knob**  
OFF 150 200 250 300  
350 400 450 500  
Broil
6. **Main Oven Knob**  
OFF 150 200 250 300  
350 400 450 500  
Broil Clean

## PGR304ZS PGR30 MODEL

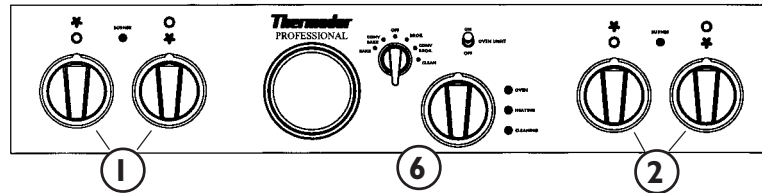

## PGR366ZS PGR36 MODELS

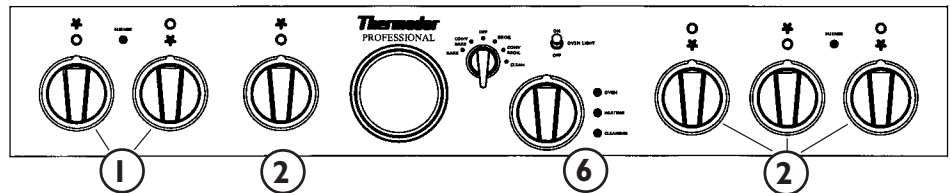

## PGR364GDZS

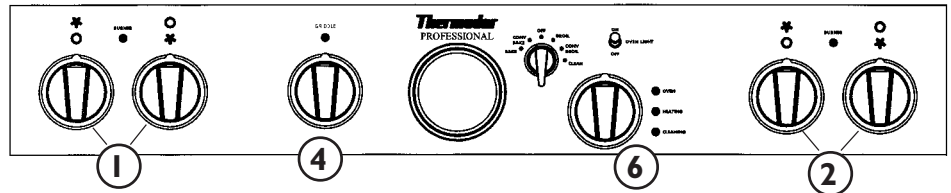

## PGR364GLZS

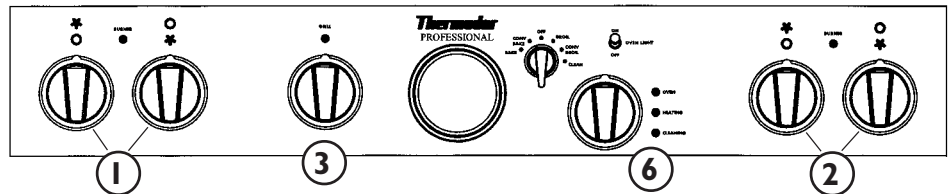

## PGR48 MODELS

### PGR484GGZS

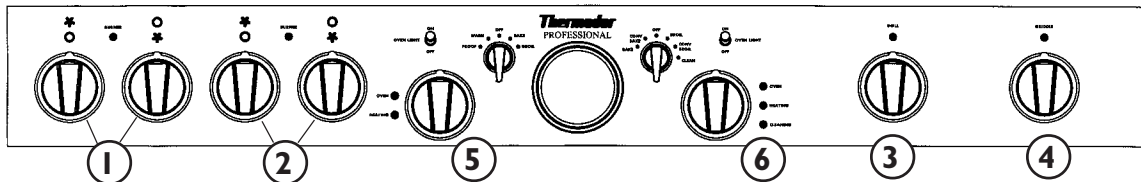

### PGR484GDZS

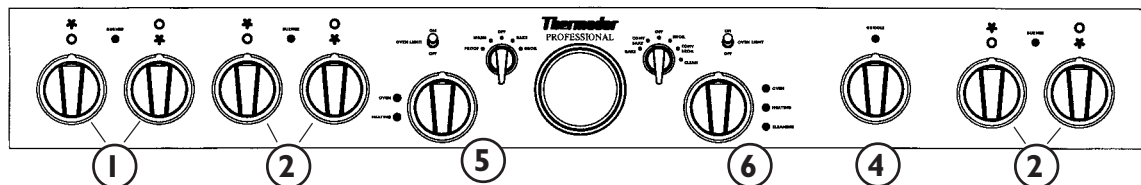

### PGR484GLZS

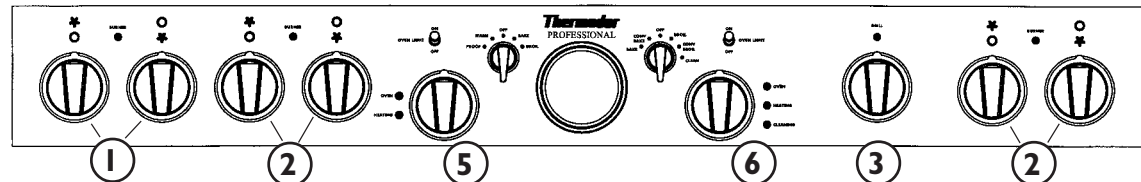

## USING THE COOKTOP

### SEALED BURNERS



The cooktop features four or six gas surface burners; each rated at 15,000 BTU/HR. The burners are sealed to the stainless steel top frame to prevent liquid spills from accumulating below the top surface, making it easier to clean.

On all models, the two left burners have the exclusive ExtraLow<sup>®</sup> feature; the remaining burners are standard. Each burner has its own control knob.

### CONTROL KNOBS

The control knobs for two sealed gas burners, one in front and one in the rear, are located directly in front of and below the pair of burners on the control panel.

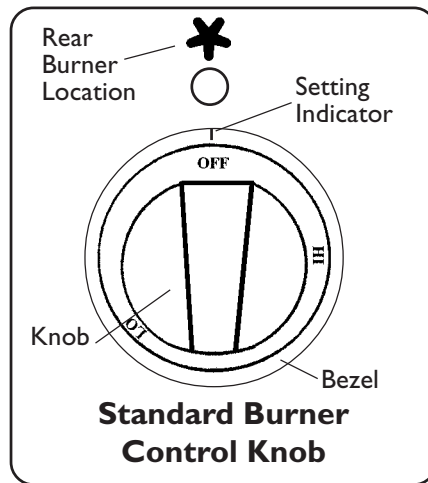

The icon above each control shows whether the burner position is in the front or in the rear. A solid star indicates the location of the burner controlled by that particular knob. The drawing above shows the knob controlling the rear burner.

### OPERATION OF THE BURNERS

- Press in on the knob and turn it counter-clockwise to the HI setting.
- The igniter for the selected sealed burner clicks and sparks.
- After flame ignition, the igniters stop clicking.
- Rotate the knob to any flame setting between HI and LO.
- The Blue Burner Signal Light, between the burners, will light when adjacent burners are lit. They will remain on until the burner is turned off.

### **BTU Output for Standard Burners**

- HI is equivalent to 15,000 BTU/HR.
- LO is equivalent to 2,100 BTU/HR.

### **BTU Output for ExtraLow<sup>®</sup> Burners**

- HI is equivalent to 15,000 BTU/HR.
- LO is equivalent to 3,000 BTU/HR.
- XLO is equivalent to 370 BTU/HR.

### **ExtraLow<sup>®</sup> Burners**

The controls for the two left burners, front and rear, have flame settings even lower than the standard LO settings.

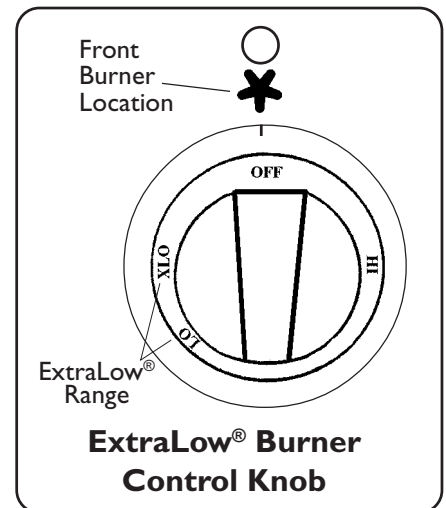

The drawing shows that the control knob has an additional range between the LO and XLO settings. When the knob is set within this range, the flame pulses off and on. By varying the length of time the flame is off and on, the heat is reduced even further to cook delicate foods. For example, these very low settings are suitable for simmering and poaching, melting chocolate and butter, holding cooked foods at temperatures without scorching or burning, etc.

## SECTION FOUR: USING THE COOKTOP

### Operation of the ExtraLow Burners

- XLO, the very lowest setting, is achieved by cycling the flame ON for approximately 8 seconds and OFF for 52 seconds of each minute.
- When the knob is set just below the LO setting, the flame will cycle ON for approximately 52 seconds and OFF for 8 seconds of each minute.
- To vary the amount of low heat to suit the food and quantity, the control can be set anywhere within the LO and XLO range marked on the knob.

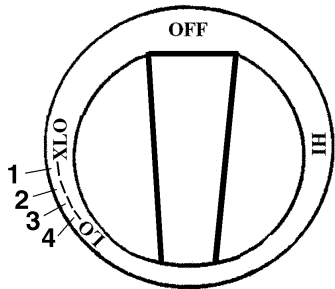

### ExtraLow Settings

- The number and dash designations, shown in the drawing, are for reference only. **They do not actually appear on the knob.** The number indicates the position of the flame setting as represented on the cooking chart, pages 17 and 18, with #4 being hotter than #1.

### ExtraLow Techniques

- The type and quantity of food affects which setting to use.
- The pan selected affects the setting. Its size, type, material, and whether a lid is used, all affect the consistency of the cooking temperature.

- To maintain a low or simmer heat, bring food to a rolling boil. Stir well, then cover the pan and lower the heat to a setting just below LO.
- Check periodically to see if the control knob should be turned to another setting.
- If an over-size pan is used, the simmer action may occur mainly in the center of the pan. To equalize the temperature throughout the food, stir the food around the outer edges of the pan into the food in the center.
- It is normal to stir food occasionally while simmering. This is especially important when simmering for several hours, such as for a homemade spaghetti sauce or beans.
- When lowering the flame setting, adjust it in small steps.
- If the setting is too low to hold a simmer, bring the food back to a boil before re-setting to a higher heat.
- It is normal not to see simmer bubbles immediately after the food has been stirred.
- There may be bubbling when the flame cycles ON and no bubbles when the flame is OFF. Even when the flame is OFF, there will be steam and a slight quiver on the liquid's surface.

### ELECTRONIC SINGLE POINT IGNITION

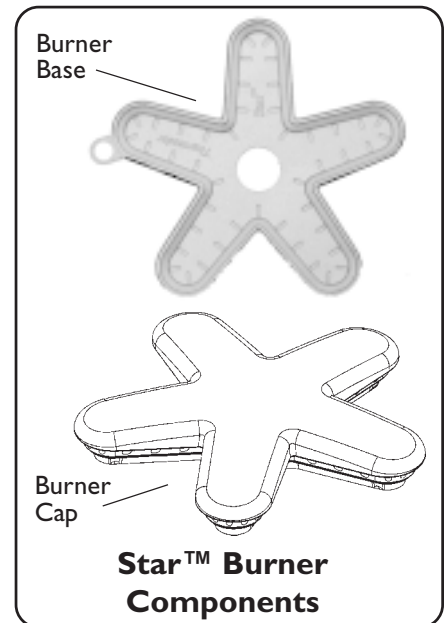

Each burner has its own electronic igniter that sparks when the burner is turned on. Each burner should light in 4 seconds or less. If a burner does not light, check to see that the cap is positioned correctly on the base. **Do not touch the burners when the igniters are sparking.** If a burner fails to ignite, refer to the section on Page 43, "Before Calling for Service."

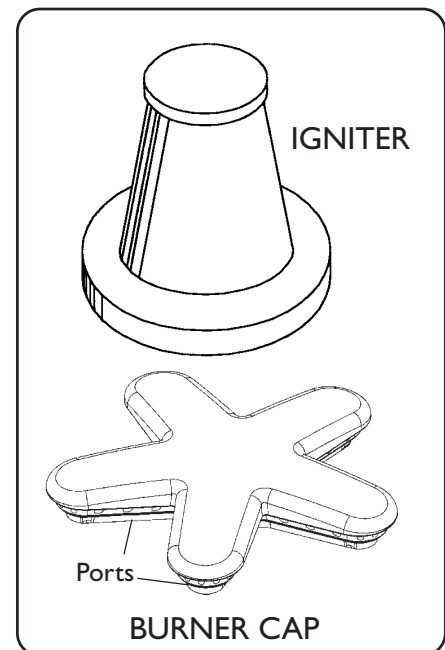

## SECTION FOUR: USING THE COOKTOP

### **AUTOMATIC RE-IGNITION**

If any one or more burners or grill blow out, the electronic igniter automatically sparks to re-light the flame. **Do not touch the burners when the igniters are sparking.**

### **IMPORTANT:**

- For proper combustion do not use the cooktop without the burner grates in place.
- There is a slight sound associated with gas combustion and ignition. This is a normal condition.
- On cooktops using propane gas (LP), a slight “pop” sound may be heard at the burner ports a few seconds after the burner has been turned off.

### **POWER FAILURE**

- In the event of a power failure, **only the standard burners and grill can be manually lit.** It is necessary to light each one individually.
- If the cooktop is being used when the power failure occurs, turn **all** knobs to the OFF position.
- The standard burners and grill can be lighted by holding a match at the ports and turning the control knob to the HI position. Wait until the flame is burning all around the burner cap or U-shaped burner before adjusting the flame to the desired height.
- Neither ExtraLow burner can be used during a power failure. **Be sure to turn them off.**
- If either ExtraLow burner is on when a power failure occurs, they cannot be turned back on until both knobs are first turned off.
- The griddle cannot be used during a power failure.
- If you smell gas, refer to safety precautions listed inside the front cover.



### **WARNING**

In the event of a power failure, all knobs are to be turned to the OFF Position. Only the standard burners and the grill can be lit manually.

### **FLAME HEIGHT**

- The correct flame height depends on 1) size and material of pan being used; 2) food being cooked; and 3) amount of liquid in the pan.
- Never extend the flame beyond the base of the pan.
- Use a low or medium flame for pan materials that conduct the heat slowly, such as porcelain coated steel or glass-ceramic.

### **FLAME DESCRIPTION**

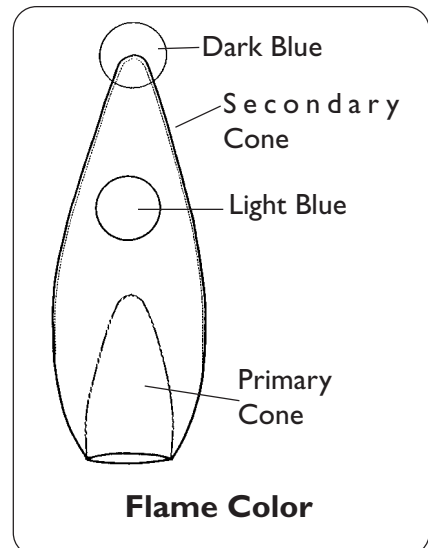

- The burner flame color should be blue with no yellow on the tips. It is not uncommon to see orange in the flame color; this indicates the burning of airborne impurities in the gas and will disappear with use.
- With propane (LP) gas, slight yellow tips on the primary cone are normal.
- The flame should burn completely around the burner cap. If it doesn't, check that the cap is positioned correctly on the base and that the ports are not blocked.
- The flame should be stable with no excessive noise or fluttering.



## COOKWARE RECOMMENDATIONS

### SAFETY PRECAUTIONS:

- ▶ Food packaged in aluminum foil should not be placed directly on the burner grate. Aluminum foil can melt during cooking.
- ▶ Do not let plastic, paper or cloth come in contact with a hot burner grate. They may melt or catch fire.
- ▶ Never let a pan boil dry. This can damage your pan and the cooking surface.

- For best cooking results, use professional quality pans with metal handles. (Plastic handles can melt or blister, if the flame extends up the side of the pan.) Professional quality pans are found at restaurant supply stores and gourmet specialty shops. All cookware should have these characteristics: good heat conductivity, good balance, correctly sized base diameter; a heavy, flat base, and a proper fitting lid.
- Aluminum and copper are pan materials that conduct the heat quickly and evenly. These metals are sometimes attached to the base or in the core between stainless steel.



**BALANCED PAN**

- Balance is important for stability and even cooking. The handle must not be heavier than the pan and tilt it unevenly. A pan must sit level on the grate without rocking or wobbling.

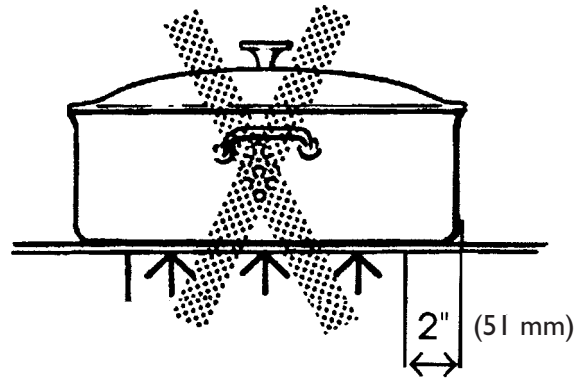

### BASE DIAMETER

- Select the base diameter to match the diameter of the flame. The diameter of the flame should be the same size as the pan base or slightly smaller. Oversize or under size pans sacrifice cooking performance. A 5-1/2" (140 mm) base size is generally the smallest recommended.

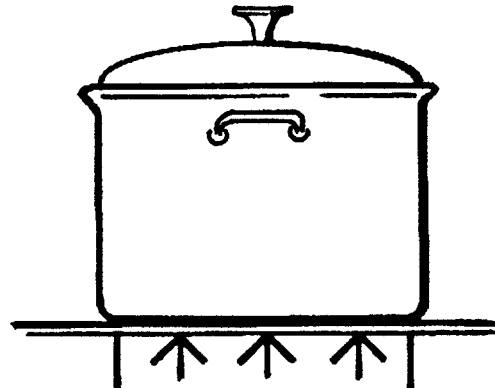

### FLAT BASE PAN

- A heavy, flat base is more apt to remain flat when heated. Pan bases that are warped, dented, ridged or too lightweight will heat unevenly. Heat and cool pans gradually to avoid sudden temperature changes which tend to distort cookware. Do not add cold water to a hot pan.

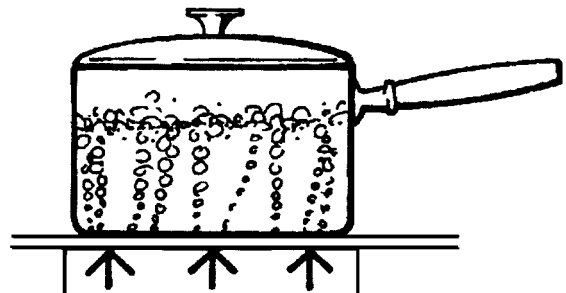

### COVERED PAN

- A properly fitting lid will shorten cooking time and make it possible to use lower heat settings.

## SPECIALTY COOKWARE

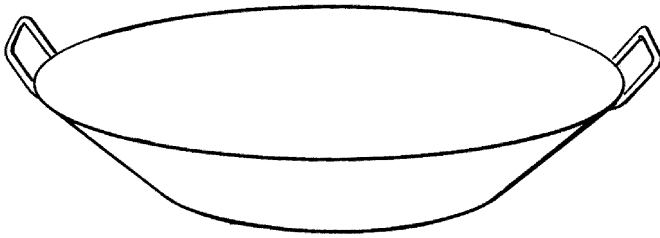

**FLAT-BOTTOM WOK PAN**

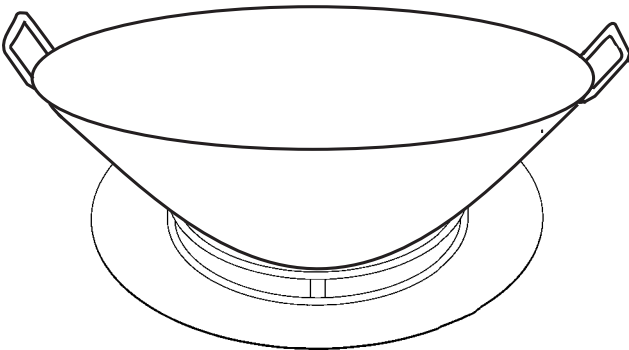

**ROUND-BOTTOM WOK  
IN SUPPORT RING**

- **Woks** – Either flat based or round bottom woks with the accessory ring can be used on models without a built-in wok burner. Round bottom woks must be used with a support ring. Place the “F” on the accessory ring facing to the front.
- **Canners and Stock Pots** – Select one with a base diameter that extends no more than 2 inches (51 mm) beyond the grate.

### **Standard Size Water Bath Canner**

21 to 22 quarts (19.95 to 20.9 liters), with an 11 to 12 inch base (279 to 305 mm) and a 9 to 11 inch depth (229 to 279 mm).

### **Standard Size Pressure Canner**

8 to 22 quarts (7.6 to 20.9 liters), with an 8 to 11 inch base (203 to 279 mm) and a 6-1/2" to 12 inch depth (165 - 305 mm).

### **CANNING TIPS:**

- A flat base pan is preferred to one with a concave, convex or rippled base.
- When using two canners at the same time, use staggered burners. Do not block air to the burners. A flame needs the right amount of air for complete combustion.
- Use a cover on a canner when bringing the contents to a boil.
- Once the contents have reached a boil on HI, use the lowest flame possible to maintain the boil or pressure.
- Canning produces a large amount of steam. Take precautions to prevent burns.

---

## COOKING CHART

### **SUGGESTIONS FOR USING THE CHART**

Use the chart on Pages 17 and 18 as a guide. The settings you use will vary depending on the pans selected and the starting temperature of the food.

On the chart, the “Finish Setting” has been separated for the standard and ExtraLow burners. There may or may not be a change between the two burner settings.

The ExtraLow setting can be either a cooking or a holding setting.

Raise or lower the flame setting gradually. Allow time for the pan and the food to adjust to the new setting.

**SECTION FOUR: USING THE COOKTOP**

## SURFACE BURNER COOKING CHART

Food	Start Setting	Finish Setting Standard Burners	Finish Setting ExtraLow® Burners
<b>BEVERAGES</b> Cocoa	<b>Med.</b> – heat milk, cover	<b>LO</b> – finish heating	<b>XLO</b> – keep warm, cover*
<b>BREADS</b> French Toast, Pancakes, Grilled Sandwiches	<b>Med.</b> – preheat skillet	<b>Med. Lo to Med.</b> – cook	Same as Standard
<b>BUTTER</b> Melting		<b>XLO</b> – to hold	<b>4 to 3</b> – allow 5 to 10 minutes to melt
<b>CEREALS</b> Cornmeal, Grits, Oatmeal	<b>HI</b> – cover, bring water to a boil, add cereal	<b>Med. Lo to Med.</b> – finish cooking according to package directions	<b>XLO</b> – to hold, cover*
<b>CHOCOLATE</b> Melting		<b>Use XLO</b>	<b>2 to XLO</b> – allow 10 to 15 minutes to melt <b>XLO</b> – to hold*
<b>DESSERTS</b> Candy	<b>Med. Lo to Med.</b> – cook following recipe	<b>Med. Lo to Med.</b>	Same as Standard
Pudding and Pie Filling Mix	<b>Lo to Med.</b> cook according to package directions	<b>Lo</b>	Same as Standard
Pudding	<b>Med. Lo</b> – Bring milk to a boil	<b>Use XLO</b>	<b>3 to 2</b> – to cook
<b>EGGS</b> Cooked in Shell	<b>HI</b> – cover, bring water to a boil, add eggs, cover	<b>Use XLO</b>	<b>XLO</b> – cook 3 to 4 minutes for soft cooked; or 15 to 20 minutes for hard cooked
Fried, Scrambled	<b>Med. to Med. HI</b> – melt butter, add eggs	<b>Lo to Med. Lo</b> finish cooking	<b>XLO</b> – to hold for a short period*
Poached	<b>HI</b> – bring water to the steaming point, add eggs	<b>4 to 3</b> - finish cooking	Same as Standard
<b>MEAT, FISH, POULTRY</b> Bacon, Sausage Patties	<b>HI</b> – until meat starts to sizzle	<b>Med. Lo to Med.</b> finish cooking	Same as Standard
<b>Braising:</b> Swiss Steak, Pot Roast, Stew Meat	<b>HI</b> – melt fat, then brown on <b>Med. HI</b> to <b>HI</b> , add liquid, cover,	<b>Use XLO</b>	<b>3 to 2</b> – simmer until tender
<b>Quick Frying:</b> Breakfast Steaks	<b>Med. HI</b> to <b>HI</b> – preheat skillet	<b>Med. HI</b> to <b>HI</b> – fry quickly	Same as Standard
<b>Frying:</b> Chicken	<b>HI</b> – heat oil, then brown on <b>Med.</b>	<b>LO</b> cover, finish cooking	Same as Standard
<b>Deep Frying:</b> Shrimp	<b>HI</b> – heat oil	<b>Med. HI</b> to <b>HI</b> – to maintain temperature	Same as Standard
<b>Pan Frying:</b> Lamb Chops, Thin Steaks, Hamburgers, Link Sausage	<b>HI</b> – preheat skillet	<b>Med. to Med. HI</b> – brown meat	<b>4 to 3</b> – to hold, covered <b>3 to 2</b> – to hold, uncovered
<b>Poaching:</b> Chicken, whole or pieces, Fish	<b>HI</b> – Cover, bring liquids to a boil	<b>Use XLO</b>	<b>2 to 1</b> – to finish cooking

**SECTION FOUR: USING THE COOKTOP**

**SURFACE BURNER COOKING CHART**

Food	Start Setting	Finish Setting Standard Burners	Finish Setting ExtraLow® Burner
<b>Simmering:</b> Stewed Chicken, Corned Beef, Tongue, etc.	<b>HI</b> – cover, bring liquid to a boil		<b>4 to 1</b> – simmer slowly
<b>PASTAS</b> Macaroni, Noodles, Spaghetti	<b>HI</b> – bring water to a boil, add pasta	<b>Med. Hi to HI</b> – to maintain a rolling boil	Same as for Standard Burners
<b>POPCORN</b> (use a heavy, flat bottom pan)	<b>HI</b> – cover, heat until kernels start to pop	<b>Med. to Med. Hi</b> – finish popping	Same as for Standard Burners
<b>PRESSURE COOKER</b> Meat Vegetables	<b>Med. Hi to HI</b> – build up pressure  <b>HI</b> – build up pressure	<b>Med. Lo to Med.</b> – maintain pressure  <b>Med. Lo to Med.</b> – maintain pressure	Same as for Standard Burners  Same as for Standard Burners
<b>RICE</b>	<b>HI</b> – cover, bring water to a boil, add rice, cover		<b>4 to 2</b> – cook according to package directions <b>XLO</b> – to hold, cover
<b>SAUCES</b> Tomato Base	<b>Med. Hi to HI</b> – cook meat/vegetables, follow recipe		<b>2 to XLO</b> – simmer (2 to 3 to thicken sauce, uncovered).
White, Cream, Bernaise,	<b>Med. Lo</b> – melt fat, follow recipe	<b>LO to Med. Lo</b> – finish cooking	<b>XLO</b> – to hold, cover*
Hollandaise	<b>Lo to Med. Lo</b>	<b>XLO</b>	<b>XLO</b> – Lowest setting
<b>SOUPS, STOCK</b>	<b>HI</b> – cover, bring liquid to a boil		<b>3 to 2</b> – simmer <b>XLO</b> – to hold, cover*
<b>VEGETABLES</b> Fresh	<b>HI</b> – cover, bring water and vegetables to a boil	<b>Med. Lo to Med.</b> – cook 10 to 30 minutes, or until tender	<b>XLO</b> – to hold, cover
Frozen	<b>HI</b> – cover, bring water and vegetables to a boil	<b>Med. Lo to Med.</b> – cook according to package directions	Same as for Standard Burners
Deep Frying	<b>HI</b> – heat oil	<b>Med. to Med. Hi</b> – maintain frying temperature	Same as for Standard Burners
In Pouch	<b>HI</b> – cover, bring water and vegetables to a boil	<b>LO to Med. Lo</b> – cook according to package directions	Same as for Standard Burners
Saute	<b>HI</b> – heat oil or melt butter, add vegetables	<b>Med. Lo to Med.</b> – cook to desired doneness	Same as for Standard Burners
Stir Fry	<b>HI</b> – heat oil, add vegetables	<b>Med. Hi to HI</b> – finish cooking	Same as for Standard Burners

\*We recommend that these foods be stirred occasionally.

## Using the Grill

**A VENTILATING HOOD** of adequate cubic-feet-per-minute capacity vented to the outside of the house is recommended for installation **ABOVE THE RANGE AND GRILL**. For most kitchens with a wall mounted hood, a certified hood is recommended. The hood must be installed according to installation instructions furnished with the hood and local building code requirements.

### THE GRILL

(Available on some models)

When cooking food on the grill you will achieve the same flavor as meat cooked on an outdoor barbecue.

This flavor is actually created by the fats and juices that are brought to the surface of the food and caramelized by the intense heat from the stainless steel radiant.

Most types of foods, steaks, chops, patties, poultry pieces, etc., cook somewhat faster on the gas grill with its constant regulated heat than on an ordinary charcoal grill.

Your new Thermador Professional® grill is equipped with an aluminized steel U-shaped tube burner typical of those used in restaurants. Automatic ignition is used to eliminate the continuous pilots found on restaurant grills. The grill burner is rated at 18,000 BTU/HR.

**NOTE:** When used with propane gas, a slight pop or flash may occur at the burner ports a few seconds after the burner has been turned off. This usually occurs after the burner has been on awhile. This is normal.

### AUTOMATIC REIGNITION

The electronic igniter automatically sparks the burner to light. **DO NOT TOUCH** any burner while the igniters are sparking.

### BURNER EFFICIENCY AND FLAME CHARACTERISTICS

The burner flame should be blue in color and stable with no yellow tips, excessive noise or lifting. It should burn completely along both sides of the burner tube.

An improper gas-air mixture may cause either a yellow tipped flame or burner flutter. Have the flame adjusted by a technician. Foreign particles in the gas line may cause an orange flame during initial use. This will disappear with use.

If the flame is uneven, flutters, makes excessive noise or lifts, check to see if the BURNER ports are clogged. If the ports are clogged, use a wire, a straightened paper clip or needle to clear the ports. If the condition persists, contact a service agency for adjustment.

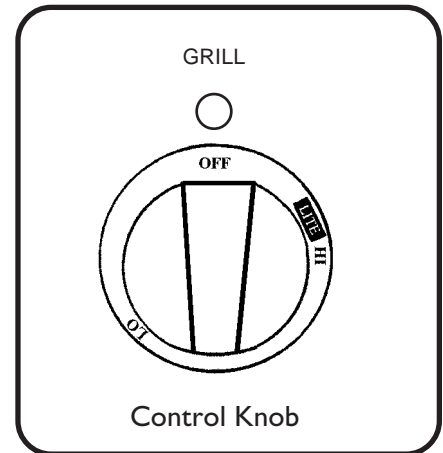

### CONTROL KNOB

The burner control has an infinite number of heat settings, and there are no fixed positions on the control knob between HI and LO. To turn the burner on, press the control knob and rotate it counterclockwise to the LITE position.

Adjust the knob to the desired heat setting.

## Disassembly/Assembly of the Grill



### CAUTION:

- Use extreme care when placing the grill components into the grill compartment. Avoid contacting the ceramic igniter which could break preventing operation of the grill.
- The grill must be assembled as shown. The drip tray heat shields must be in place, and the burner must be properly positioned relative to the gas supply. Incorrect assembly of the grill may result in unsafe or hazardous conditions during operation.
- Do not leave the grill unattended while in use.
- Do not use charcoal briquettes or coals of any kind.

Follow the steps below to disassemble the components in the grill box.

- A. Remove the grill grate, stainless steel radiant and burner from the grill box.
- B. Remove the rectangular drip pan inside the grill box as shown below.
- C. Install the heat deflector into slots of front panel of grill box.
- D. Insert the end of the burner into the slots at the back of the grill box. Insert the tab on front of the burner into slot in the heat deflector.
- E. The stainless steel radiant lies on two (2) studs on each end of the grill can.
- F. Place the grill grate, with raised food containment rail oriented towards the grill box rear.
- G. To reassemble the grill, follow these instructions in reverse order.

### Exploded Views and Side View of Grill

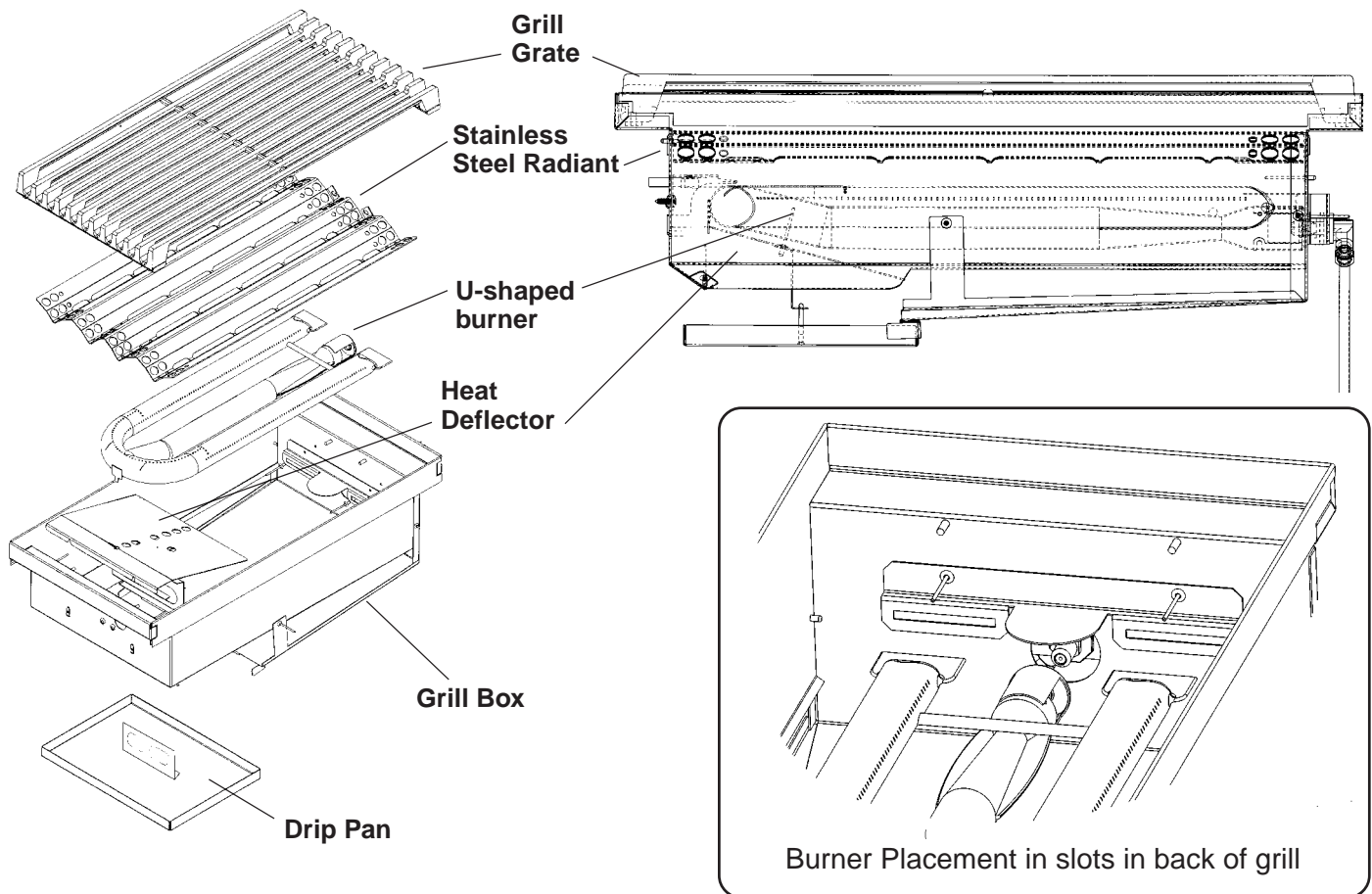

## **USING THE GRILL**

### **COOKING ON THE GRILL**

- The burner should light within approximately 5 seconds.
- Preheat grill for 10 to 15 minutes minimum. The hot grill sears the food, sealing in the juices. The longer the preheat, the faster the meat browns and the darker the grill marks.
- Grilling requires high heat for searing and proper browning. Most foods are cooked at the higher heat settings for most of the cooking time. However, when grilling large pieces of meat or poultry, it may be necessary to turn the heat to a lower setting after the initial browning. This cooks the food through without burning the outside.
- Foods cooked for a long time or basted with a sugary marinade many need a lower heat setting near the end of the cooking time.
- After grilling and the food has been removed, turn the knob to HI and burn off any excess grease which has accumulated on the stainless steel radiant.
- Use a brass wire brush, dipped in hot water, to loosen food particles from the grate.
- When the grill has cooled, clean the drip tray, radiant, heat deflector and compartment. Wipe the U-shaped burner with a damp cloth.

### **GRILLING SUGGESTIONS**

- ◆ Trim any excess fat from the meat before cooking. Cut slits in the remaining fat around the edges at 2" (51 mm) intervals.
- ◆ Brush on basting sauce toward the end of cooking.
- ◆ Use a spatula or tongs instead of a fork to turn the meat. A fork punctures the meat and lets the juices run out.
- ◆ Add seasoning or salt after grilling.
- ◆ The grill grate has side and rear rails designed to make it easier to turn with a spatula.
- ◆ After the juices begin to bubble to the surface, turn the meat only once. This helps keep the juices in the meat.
- ◆ Some pieces of meat and poultry cook faster than others. Move those pieces to the cooler area of the grill until the rest have finished.
- ◆ The doneness of meat is affected by the thickness of the cut. Chefs say it is impossible to have a rare doneness with a thin cut.
- ◆ Do not leave the grill unattended while cooking.

### **HANDLING EXCESSIVE FLARE-UPS**

- ◆ The intense heat needed for grilling may also cause flare-ups due to grease dripping on the stainless steel radiant.
- ◆ If flare-ups occur, use a long handled spatula to move the food to another area of the grill.
- ◆ Should flare-ups become excessive, remove the food from the grill and turn off the burner.
- ◆ Excessive flames occur when cooking meat with extra fat, i.e. 30% ground beef, untrimmed steaks, lamb chops, etc.
- ◆ Be cautious when turning meat over.
- ◆ It is important that grilling be supervised at all times.

**SECTION FOUR: USING THE COOKTOP**

**GRILL COOKING CHART**

<b>Food</b>	<b>Weight or Thickness</b>	<b>Control Setting</b>	<b>Total Suggested Cooking Time</b>	<b>Special Instructions and Tips</b>
<b>MEATS</b> <b>Beef</b> Hamburgers  Steaks Rib, Club, Tenderloin, Porterhouse, T-Bone, Sirloin Rare (140°F)  Medium (160° F)  Well-Done (170° F)	1/2 to 3/4 inch (13 mm to 19 mm)	Medium  High	14 to 18 minutes  12 to 15 minutes	Grill, turning once when juices rise to the surface. Do not leave hamburgers unattended since a flare up can occur quickly.  Remove excess fat from edge. Slash remaining fat at 2-inch (51 mm) intervals. Grill, turning once.
	1" (25 mm)	High	10 to 14 minutes	
	1-1/2" (38 mm)	High	13 to 18 minutes	
	1" (25 mm)	Medium to	14 to 22 minutes	
	1-1/2" (38 mm)	High	18 to 27 minutes	
	1" (25 mm)	Medium	22 to 32 minutes	
	1-1/2" (38 mm)	Medium	27 to 37 minutes	
<b>Lamb</b> Chops & Steaks Rare (140°F)  Medium (160°F)  Well-Done (170°F)	1" (25 mm)	High	12 to 15 minutes	Remove excess fat from edge. Slash remaining fat at 2-inch (51 mm) intervals. Grill, turning once.
	1-1/2" (38 mm)	High	14 to 18 minutes	
	1" (25 mm)	Medium to	15 to 20 minutes	
	1-1/2" (38 mm)	High	18 to 25 minutes	
	1" (25 mm)	Medium	20 to 30 minutes	
<b>Pork</b> Chops  Ribs	1/2" (13 mm)	Medium	20 to 40 minutes	Remove excess fat from edge. Slash remaining fat at 2-inch (51 mm) intervals. Grill, turning once. Cook well done.
	1" (25 mm)	Medium	35 to 60 minutes	
		Medium	45 to 60 minutes	Grill, turning occasionally. During last few minutes brush with barbecue sauce, turn several times.

*Chart continued, please see next page*



**SECTION FOUR: USING THE COOKTOP**

**GRILL COOKING CHART**

<b>Food</b>	<b>Weight or Thickness</b>	<b>Control Setting</b>	<b>Total Suggested Cooking Time</b>	<b>Special Instructions and Tips</b>
<b>MEATS</b> <b>Pork</b> Ham Steaks (precooked)  Hot Dogs	1/2 inch	High	4 to 8 minutes	Remove excess fat from edge. Slash remaining fat at 2-inch (51 mm) intervals. Grill, turning once.
		Medium	5 to 10 minutes	Slit skin. Grill, turning once.
<b>POULTRY</b> Chicken Broiler/Flyer Halved or Quartered  Breasts, bone-in	2 to 3 pounds	Low or Medium	1 to 1-1/2 hours 40 to 60 minutes	Place skin side up. Grill, turning 2 to 3 times.
		Medium	30 to 45 minutes	
<b>FISH AND SEAFOOD</b> Steaks Halibut, Salmon, Swordfish Whole Catfish, Rainbow Trout	3/4 to 1 inch	Medium to High	8 to 15 minutes	Grill, turning once. Brush with melted butter, margarine or oil to keep moist.
	8 to 16 ounces	Medium to High	20 to 30 minutes	Grill, turning once. Brush with melted butter, margarine or oil to moisten.

## SECTION FOUR: USING THE COOKTOP

### ABOUT THE GRIDDLE

(Available on some models)

#### DESCRIPTION

The built in griddle is made of restaurant quality aluminum coated with titanium. This produces a surface with even heat that is easy to clean.

The griddle has an aluminized steel tube burner that is lit by a spark igniter. The griddle should light within 4 clicks of the igniter. This eliminates the need for a continuous burning pilot lighter.

A maple chopping block is available as an accessory and purchased separately. It is sized to fit on top of the surface when the griddle is not being used.

•The burner is rated at 15,000 BTU / HR.

#### CONTROL KNOB

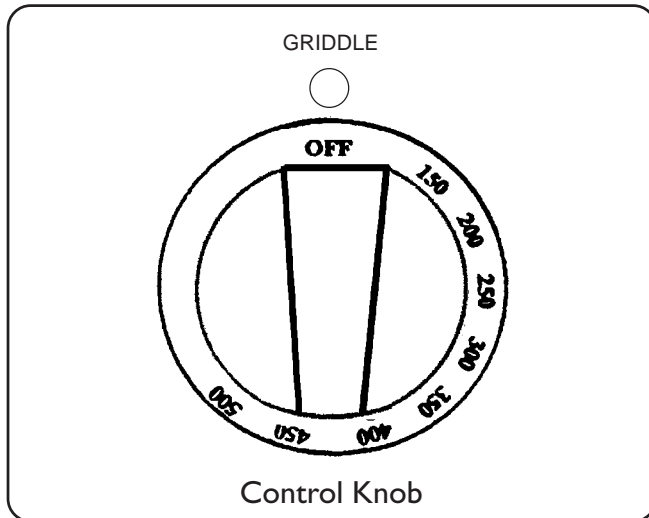

- The griddle is electronically controlled with temperatures marked on the knob from 150°F to 500°F.
- There are no fixed settings on the knob.
- Press and turn the knob counter-clockwise to the temperature setting.

#### PREPARING THE GRIDDLE

The griddle must be level or tilted slightly forward for optimum performance. The griddle should have been leveled during installation. If not, the griddle can be leveled by removing the griddle plate and frame then adjusting the leveling screws at the front and back of the griddle opening.

The griddle plate should be washed with warm soapy water then rinsed with clear water prior to use. The griddle may be used without any butter, margarine or oil. However, a very small amount may be used to flavor foods. Any utensil, including metal ones may be used on the griddle surface. Care should be taken so the surface is not gouged when metal utensils are used.

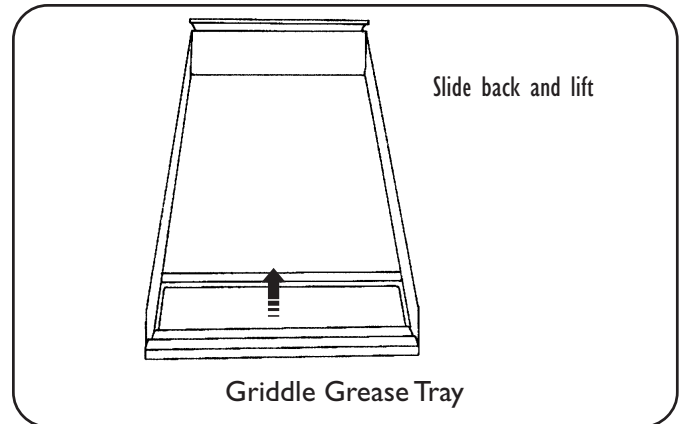

#### GRIDDLE GREASE TRAY

- Push the tray under the front edge of the griddle overhang to catch grease or food residue.
- Use a metal spatula to scrape the grease and food particles forward from the surface into the tray.
- Clean the tray after every use. When removing the tray, use care when tipping it so that the contents do not spill.

#### Cooking on the Griddle

1. Check that the grease tray is tucked under the griddle plate overhang.
2. Turn the knob to the cooking temperature to preheat the griddle.
3. Preheat 10 to 15 minutes.
4. Add butter, margarine, oil or shortening for more flavor.
5. Add the food and cook.

#### GRIDDLE COOKING CHART

FOOD	SETTING
Bacon, Ham, Pork Chops	350°F to 375°F (177°C to 190°C)
Eggs	300°F to 325°F (150°C to 160°C)
Pancakes, French Toast	350°F to 375°F (177°C to 191°C)
Potatoes, Hash Brown	400°F to 425°F (205°C to 219°C)
Sandwiches, Sausage	350°F to 375°F (177°C to 191°C)

# Bake

## RACK POSITIONS

### TIPS FOR BAKE

#### PREHEATING THE OVEN

Many foods such as meat, poultry, casseroles, or other long cooking foods cook well without preheating the oven. See your recipe for preheating recommendation. Preheating time depends on the temperature setting and the number of racks in the oven.

#### GETTING THE BEST RESULTS

- ▲ Minimize opening the door:
  - Use a minute timer.
  - Use the interior oven lights.
- ▲ Choose the right size utensil; use the utensil recommended in the recipe.
- ▲ Store the broiler pans outside the ovens. An extra pan without food, affects the browning and cooking.
- ▲ The type of pan used affects the browning:
  - For tender, golden brown crusts, use light non-stick/anodized or shiny metal utensils.
  - For brown crisp crusts, use dark non-stick/anodized or dark, dull metal utensils or glass bakeware. These may require lowering the bake temperature 25°F.

#### BAKEWARE

##### ■ Type

- ▲ Metal bakeware (with or without a non-stick finish), heat-proof glass, glass-ceramic, pottery, or other utensils suitable for the oven.
- ▲ Suitable cookie sheets have a small lip on one side only.
- ▲ Large oven will hold a full commercial baking sheet (18" x 26").

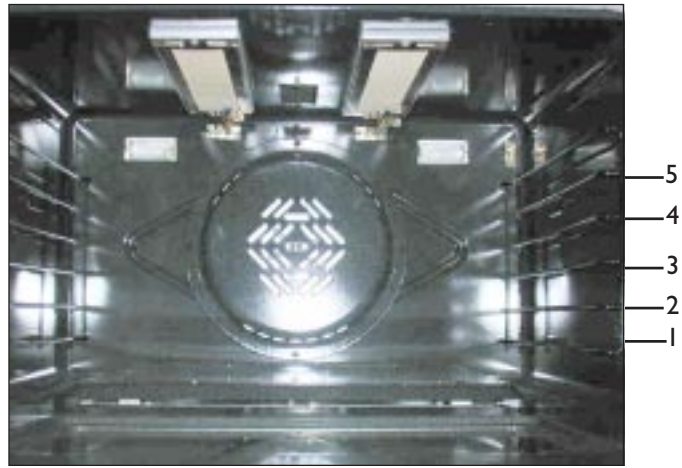

**Large Gas Main Oven**

#### Bake Rack Positions

Rack positions in the oven are numbered like an elevator. Number one position is the lowest rack and number five is at the top.

#### LARGE MAIN OVEN

##### One Rack Baking

- The Bake Mode is best for baking on one rack with rack #3 used for most baked items. If the item is tall such as an angel food cake rack #2 may be used. Pies are best baked on rack #2 to make certain the bottom of the crust is done without over browning the top. When large pieces of meat or poultry such as a prime rib of beef or a turkey is roasted, rack #2 is the preferred rack.

##### Two Rack Baking

- Racks #2 and #5 may be used when baking on two levels. Foods such as cookies and biscuits work well using these two racks. Casserole dishes may also be baked using these two racks.

##### Three Rack Baking

- If three rack baking is desired, the Convection Bake mode should be used.

#### 12 INCH AUXILIARY OVEN (PGR48 Models)

- Baking on rack #3 will result in the best product. When additional height is needed, rack #2 may be used. The use of rack #2 with pies will result in a crisp bottom crust without over baking the top.
- If two rack baking is desired in this small oven, use racks #2 and #5. For best results, stagger baking pans front to rear with the pan on rack #2 toward the rear and the pan on rack #5 toward the front.

##### ■ Placement

- ▲ Allow at least 1" of space between the pans and the oven walls so heat can circulate around each pan.
- ▲ Stagger baking utensils so that one is not directly above another. Allow 1-1/2 inches above and below each pan.

# Convection Bake

## TIPS FOR CONVECTION BAKE

### PREHEATING THE OVEN

Many foods such as meat, poultry, casseroles, or other long cooking foods cook well without preheating the oven. See your recipe for preheating recommendation. Preheating time depends on the temperature setting and the number of racks in the oven.

### HIGH ALTITUDE BAKING

When baking at high altitudes, in either **BAKE** or **CONVECTION•BAKE**, recipes and baking times vary. For accurate information, write the Extension Service, Colorado State University, Fort Collins, Colorado 80521. There may be a cost for the bulletins. Specify the type of information you want (example: cakes, cookies, breads, etc.).

### CONDENSATION

It is normal for a certain amount of moisture to evaporate from the food during **any** cooking process. The amount depends on the moisture content of the food. The moisture will condense on any surface cooler than the inside of the oven, such as the control panel.

## CAUTION

### ■ WHEN USING THE OVEN IN ANY MODE

**Never use aluminum foil to cover the oven racks or to line the oven.** It can damage the oven and cause a fire hazard if heat is trapped under it.

### RACK POSITIONS LARGE MAIN OVEN

#### One Rack Baking

- When baking on one rack, best results are obtained in the bake mode (see Bake).
- When roasting a turkey or a large piece of meat, convection bake may be used. Rack #2 is the most appropriate rack.

#### Two Rack Baking

- Racks #2 and #5 are most appropriate when using the convection bake mode. Pans should not be staggered but the baking pan on rack #5 should be placed on rack #2 directly under the one on rack #5.
- This may be used for cakes, cookies, biscuits and other foods for which two rack baking is desirable.
- When several casseroles, frozen pies or cakes are to be baked, use racks #2 and #5.
- These two racks can also be used for a large oven meal.

#### Three Rack Baking

- When several sheets of cookies are to be baked, bake them on racks #1, #3, and #5. Place the baking sheets directly on top of each other on the respective racks to allow air to flow around the baking sheets.

### BAKEWARE

#### Type

- Aluminum bakeware gives the best browning results.
- Cookie sheets should have low sides; use aluminum commercial half-sheets or professional cooking utensils.

#### Placement

- For better browning, utensils such as cookie sheets, jelly roll pans and rectangular baking pans should be placed crosswise on the rack with the shorter sides on the right and the left. This allows the air to circulate freely.
- When baking on more than one rack, pans should not be staggered.

## SECTION FIVE: USING THE OVEN

# Setting Bake/Convection Bake

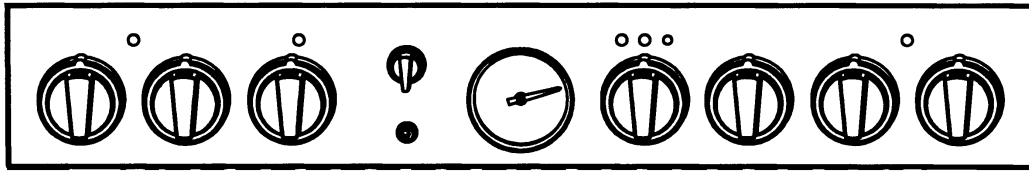

### BAKE/CONVECTION BAKE

These cooking modes are for baking, roasting or warming using one, two or three racks.

### TO SET THE GAS OVEN

#### 1. Select BAKE or CONVECTION•BAKE using the Selector switch.

#### 2. Set Temperature using the Oven Control Knob.

- ▲ The convection fan turns on six minutes after the oven is turned on, if **CONVECTION BAKE** is selected.
- ▲ The **OVEN** and **HEATING** lights turn on.
- ▲ The **HEATING** light cycles off and on. The oven is preheated when the **HEATING** light cycles off the first time.
- ▲ The **OVEN ON** light illuminates and remains on until the **OFF** Selector switch is turned off or the oven control knob is turned to the **OFF** position.
- ▲ The needle of the gauge in the center of the control panel moves to the selected temperature. **The gauge is for reference only.**

### OVEN CONTROL KNOBS

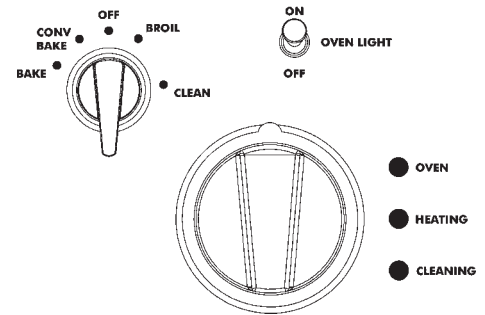

**NOTE:** When the oven is used for an extended period of time at a high temperature, the cooling blower will turn on. This is normal. This cooling blower will also operate during Broil and during the Self-Cleaning cycle. **If the blower is not running during these modes, do not use the oven.** Call a qualified appliance technician to repair the unit.

### TO SET THE 12-INCH OVEN

#### 1. Select BAKE using Selector switch.

#### 2. Set Temperature using the Oven Control Knob.

- ▲ The **OVEN ON** light turns on.
- ▲ The **HEATING** light turns on.
- ▲ The **HEATING** light cycles off and on. The oven is preheated when the **HEATING** light cycles off the first time.
- ▲ The **OVEN ON** light remains on until the Selector switch is turned off.

### OVEN CONTROL KNOBS

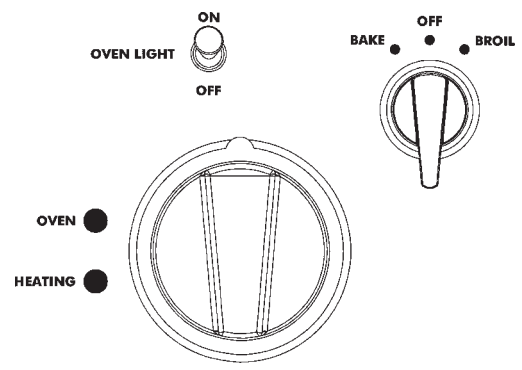

# Other Uses of Bake

## SLOW COOKING AND LOW TEMPERATURE USES OF THE OVEN

In addition to providing perfect temperatures for baking and roasting, the oven can be used at low oven temperatures to keep hot, cooked foods at serving temperature, to dehydrate food and to warm plates.

Hot cooked foods can be kept at serving temperatures. Set the oven to bake and use the temperature suggested on the chart.

Foods needing to be kept moist must be covered with a lid or aluminum foil.

### FOOD SAFETY

**The United States Department of Agriculture advises: DO NOT hold foods at temperatures between 40°F to 140°F more than 2 hours. Cooking raw foods at below 275° F is not recommended.**

### Suggested Temperature Chart to Keep Food Hot

FOOD	OVEN TEMPERATURE °F
Beef	
Rare .....	140° - 155°F
Medium .....	155° - 170°F
Well done.....	170° - 180°F
Bacon .....	200° - 225°F
Biscuits and Muffins (covered) .....	170° - 185°F
Casserole (covered) .....	170° - 200°F
Fish and Seafood .....	170° - 200°F
French Fried Foods .....	200° - 225°F
Gravy or Cream Sauces (covered) .....	170° - 180°F
Lamb and Veal Roasts .....	170° - 200°F
Pancakes and Waffles (covered) .....	200° - 225°F
Potatoes	
Baked .....	200°F
Mashed (covered).....	170° - 185°F
Pies and Pastries .....	170°F
Pizza (covered).....	225°F
Pork .....	170° - 200°F
Poultry (covered) .....	170° - 200°F
Vegetables (covered) .....	170° - 175°F

## OVEN CONTROL KNOBS

12" GAS OVEN

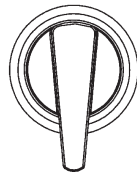

LARGE GAS MAIN OVEN

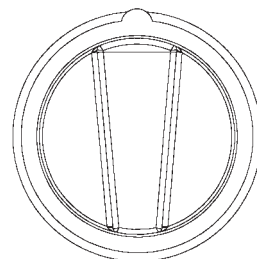
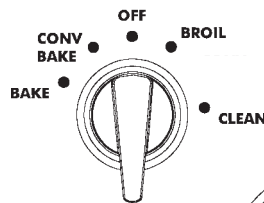

- OVEN ●
- HEATING ●

- OVEN ●
- HEATING ●
- CLEANING ●

**SECTION FIVE: USING THE OVEN**

# Baking Chart

<b>Food</b>	<b>Pan Size</b>	<b>Control Temperature Setting</b>	<b>Total Suggested Cooking Time</b>	<b>Special Instructions and Tips</b>
Cookies	12"x15" Cookie Sheet	375°	8 to 12 minutes	Follow recipe instructions
Layer Cakes	8" or 9" Round	350°	25 to 35 minutes	Follow recipe instructions
Sheet Cakes	9"x13" Pan	350°	30 to 40 minutes	Follow recipe instructions
Bundt™ Cakes	12 Cup	325°	60 to 75 minutes	Follow recipe instructions
Brownies or Bar Cookies	9"x9" Pan	325°	20 to 25 minutes	Follow recipe instructions
Biscuits	12"x15" Cookie Sheet	425° or Package Directions	10 to 15 minutes	Follow recipe or package directions
Quick Bread	8"x4" Loaf Pan	350°	55 to 70 minutes	Follow recipe or package directions
Muffins	12 cup Muffin Pan	425°	14 to 19 minutes	Follow recipe or package directions
Fruit Pies	9" Diameter	425°	35 to 45 minutes	Follow recipe instructions
Fruit Cobblers	9"x9" Pan	400°	25 to 30 minutes	Follow recipe instructions
Yeast Bread, Loaves	8"x4" Loaf Pan	425°	25 to 30 minutes	Follow recipe instructions
Dinner Rolls	9"x13" Pan	400°	12 to 18 minutes	Follow recipe instructions

# Broil

## BROIL

### TIPS FOR BROIL

### PREHEATING THE BROILER

**It is recommended that you preheat the broil element before starting to cook.** Preheat until the dial reaches broil.

### GETTING THE BEST RESULTS

- ▲ Be sure to defrost food before broiling.
- ▲ Door may be ajar or closed during broiling.
- ▲ Steaks should be at least 1" thick if rare meat is desired.
- ▲ Turn foods over only once, after half the total cooking time. It is not necessary to turn very thin foods (ham slices, fillets of fish, etc.). Liver slices must be turned over regardless of thickness.
- ▲ Use a minute timer. Set it for the minimum time to check the food.
- ▲ Center foods directly under the infrared burners for best browning.
- ▲ To avoid burning chicken skin, remove it before broiling.

## RACK POSITIONS

Before turning on the oven, place the rack in the desired position. After preheating the broiler, center the broil pan directly under the infrared burners.

### Gas Oven

- #5 Use this rack position when broiling beef steaks, ground meat patties, ham steak and lamb chops 1 inch or less in thickness. Also, use when top browning foods.
- #4 Use this rack position when broiling meat 1-1/8 inches or more in thickness, fish, poultry, pork chops, ham steaks 1 inch or more in thickness.
- #3 Use this rack when broiling chicken halves (remove skin).

### UTENSILS

- ▲ The chrome and porcelain enamel two-piece broil pan and grid is included with the range. **DO NOT** cover the slotted grid (top) with aluminum foil.
- ▲ Use metal or glass-ceramic bakeware when top browning casseroles, main dishes, or bread.
- ▲ **DO NOT** use heat-proof glass or pottery. This type of glassware cannot withstand the intense heat of the broil element.
- ▲ The two-piece aluminum broiler pan is designed to be used in the 12" Auxiliary Oven in the PGR48 Ranges.

## BROILING USING A REGULAR MEAT THERMOMETER

For accurately determining the degree of doneness for a thick steak or chop (at least 1-1/2 inches thick), use a regular meat thermometer. Insert the point of the thermometer into the side of the meat to the center of the steak or chop.

For rare steaks, cook the first side to 90°F. For medium or well done steaks, cook the first side to 100°F. Turn and cook the second side to desired internal temperature.

### Small Gas Oven (Models PGR48)

Foods may be broiled on racks #3, 4 or 5 depending upon the type and thickness of the food. Rack #5 may be used for top browning of foods.

### NOTE:

It is impossible to use the oven and the broiler simultaneously. When one is on, the other one cannot be turned on.



## Setting Broil for Gas Oven

### **BROIL - Gas Oven**

Only the infrared burners heat in the BROIL mode.

Place rack in recommended position on Page 32. Before placing food in the oven for broiling, preheat the broiler element until the dial reaches “Broil.”

**NOTE:** Successful broiling requires constant exposure to high, intense heat .

### **To Set the Oven to Broil**

1. **Place oven rack in desired position.**
2. **Set Selector Switch to Broil.**
3. **Set Oven Control Knob to BROIL setting.**
4. **The door may ajar or closed throughout broil cycle.**
  - ▲ Your Professional® Range comes with a large two-piece broil pan. The slotted grid allows drippings to flow into the lower pan, away from the intense heat of the broil burners, minimizing spattering and smoking.
  - ▲ The PGR48 Models have a small two-piece aluminum broiler pan. It is to be used in the small auxiliary oven.

### **Oven Heating Light**

This light turns on when the oven heats and cycles off when the set temperature has been reached. The cycling continues as long as a BROIL mode is set.

**SECTION FIVE: USING THE OVEN**

# Broiling and Roasting Chart

All meats are placed on the broiler pan included with the range.

Food Item	Rack Number	Oven Mode	Control Temperature Setting	Approximate Cooking Time	Special Instructions and Tips
<b>Beef</b> Ground Beef Patties, 1/2" thick	5	Broil	Broil	15 to 20 minutes	Broil until no pink in center
T-Bone Steak	5	Broil	Broil	12 to 20 minutes	Time depends on rareness of steak
Flank Steak	5	Broil	Broil	12 to 20 minutes	Rare to Medium rare is best
Eye of Round Roast	3	Bake	325°	20 to 25 min/lb	Small roasts take more minutes per pound
<b>Pork</b> Loin Roast	5	Bake	325°	20 to 25 min/lb	Cook until juices are clear
<b>Poultry</b> Boneless, Skinless Chicken Breasts	4	Broil	Broil	20 to 25 minutes	Cook until juices are clear
Chicken Thighs	4	Broil	Broil	25 to 30 minutes	Remove skin; Cook until juices are clear
Half Chickens	3	Broil	Broil	30 to 45 minutes	Remove skin; Turn with tongs
Roast Chicken	3	Bake	350° min	75 to 90 min	Roast with breast side down to keep breast moist.
Turkey	2	Bake	325° min	20 to 25 min/lb	Roast Unstuffed

# Self-Cleaning the Oven

## LARGE GAS MAIN OVEN

The self-cleaning mode of your new range features pyrolytic self-cleaning. When set to the **CLEAN** mode, the oven reaches a high temperature that burns off the food soil.

When the oven is set for **CLEAN**, only the cooktop burners (four or six) may be used. The 12-inch oven (Model PGR48 only), the griddle and/or the grill cannot be used.

**It is common to see smoke and/or flames during the CLEAN cycle**, depending on the content and amount of soil remaining in the oven. If a flame persists, turn off the oven and allow it to cool before opening the door to wipe up the excessive food soil.

**At the end of the CLEAN cycle**, some gray ash or burned residue may remain inside the oven. This is a mineral deposit that does not burn or melt. The amount of ash depends on how heavily soiled the oven was before it was cleaned. It is easily removed, when the oven is cold, using a damp paper towel, sponge, or cloth.

Wipe off any smoke residue that remains on the front frame with Formula 409® or Fantastik®. If stain remains, use a mild liquid cleanser. The amount of smoke stain is directly related to the amount of food soil left in the oven at the time of self-cleaning. Clean the oven often.

## LOCK

When the **CLEAN** cycle starts, the **LOCK** light turns on, and the automatic door lock cycle begins. Check the door when the LOCK light comes on to confirm that it is locked. You can stop the clean cycle by selecting the **OFF** position. The lock light will turn off only after the oven has cooled below 550°F, and the automatic door lock has completed its cycle to the open position.

**Make certain that the oven door is locked at the beginning of the self-cleaning cycle.**

## BEFORE SELF CLEANING THE OVEN

- Remove all utensils.
- Remove Racks.
- Clean the oven front frame and outer door edges. Wipe up large spillovers and grease.
- Be sure the light bulbs and glass covers are in place.
- Turn on the ventilator hood above the range and leave it on until after the oven has completed the self-clean cycle.

Wipe out puddles of grease and any loose soil that can be easily removed.

Remove any soil that is outside the door seal area. This appliance is designed to clean the oven interior and that portion of the door that is inside the oven. The outer edges of the door and the oven cavity are not in the cleaning zone. Wipe this area clean **BEFORE SETTING THE OVEN TO SELF-CLEAN.**

**NOTE: For the first Self-Cleaning cycle, remove small animals and birds from the kitchen and surrounding areas. Open a nearby window for additional ventilation.**

## **SELF CLEANING THE OVEN**

### **To Set Self-Clean for the Large Main Self-Cleaning Oven**

1. Select **CLEAN** using the Selector switch.
2. Set Oven Control Knob to **CLEAN**.
  - ▲ Cooling Blower turns on.
  - ▲ **OVEN ON** light and **HEATING** light turn on.
  - ▲ LOCK light turns on.
  - ▲ The door closing process takes approximately 60 seconds to complete, at which time the door becomes locked. **Check to make certain the door is locked.**

### **OVEN CONTROL KNOBS**

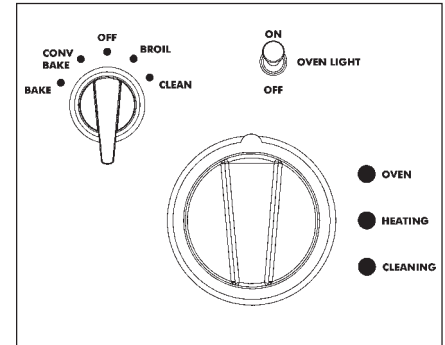

### **AT THE END OF THE CLEAN CYCLE**

The Clean cycle takes 4 to 5 hours to complete. The blower and the **OVEN ON** light and the **CLEAN** light turn off when the cycle is finished. Do not turn the selector switch or the oven control knob to the OFF position until the LOCK light goes off.

1. Select **OFF** using the Selector Switch.
  - ▲ The door latch will open automatically when the oven is below 550°F and the automatic Door Lock completes its 60 second cycle to the OPEN position.
2. Turn Oven Control Knob to **OFF** position.

### **CAUTION**

The interior of the oven will still be at baking temperatures when the **LOCK** light turns off and the oven door can be opened.

### **CLEANING HINTS**

1. The porcelain enamel finish is acid resistant, but not acid proof. Acidic foods, such as citrus juices, tomatoes, rhubarb, vinegar, alcohol or milk, should be wiped up and not allowed to bake onto the porcelain during the next use.
2. **Remove the oven racks.** See Racks, on Range Cleaning Chart, Page 40.
3. **The infrared burner in the oven does not require cleaning;** the elements burn themselves clean when the oven is in use.
4. Use caution when cleaning the the 12-inch auxiliary oven in the PGR48 range. Use hot sudsy water; rinse and dry thoroughly.

**RANGE CLEANING**  
**WHEN CLEANING THIS**  
**RANGE:**

**⚠ CAUTION**  
 Avoid cleaning any part of  
 the range while it's hot.

1. Use the mildest cleaning procedure that will do the job efficiently and effectively. Some cleaners of the same type are harsher than others. Try on a small area first.
2. Always rub metal finishes in the direction of the polish lines for maximum effectiveness and to avoid marring the surface.
3. Use only clean soft cloths, sponges, paper towels, fibrous brushes, plastic, non-metal or steel wool soap pads for cleaning and scouring, as recommended on the chart.
4. Any part of this appliance can be cleaned with hot sudsy water. When rinsing is required, rinse thoroughly.
5. Always wipe dry immediately to avoid water marks.

**BRAND NAMES**

The use of brand names is intended only to indicate a type of cleaner. This does not constitute an endorsement. The omission of any brand name cleaner does not imply its adequacy or inadequacy. Many products are regional in distribution and can be found in the local markets.

It is imperative that all products be used in strict accordance with instructions on the package.

The following chart gives directions for cleaning this range:

**COOKTOP CLEANING CHART**

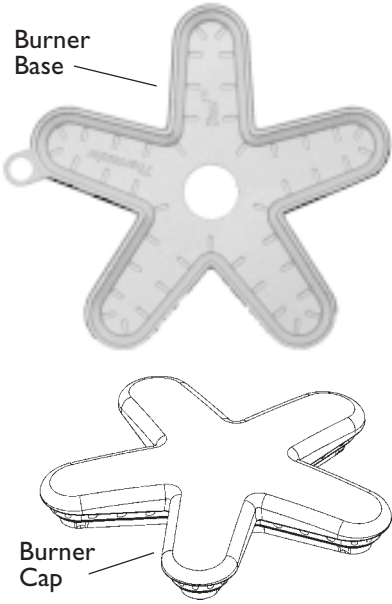
Cooktop Part / Material	Suggested Cleaners	Important Reminders
<p><b>Burner Base and Cap and Spill Tray/</b>                      Stainless Steel</p>  <p><b>Star™ Burner Components</b></p>	<ul style="list-style-type: none"> <li>• Hot sudsy water; rinse and dry thoroughly.</li> <li>• Mild Abrasive Cleansers: Bon Ami®, Ajax®, Comet®.                      Liquid cleaners: Kleen King®.</li> <li>• Stiff nylon bristle tooth brush to clean port openings.</li> <li>• Reassemble as shown. Make sure that the burner cap is seated on the base.</li> </ul>	<ul style="list-style-type: none"> <li>• Acidic and sugar-laden spills deteriorate the stainless steel. Remove soil immediately.</li> <li>• Do not scratch or gouge the port openings of burner cap.</li> </ul>
<p><b>Control Knobs/Plastic Bezels/Chrome</b>  <i>Please see Guide to Knob Identification and Location on Page 11.</i></p>	<ul style="list-style-type: none"> <li>• Hot sudsy water; rinse and dry immediately.</li> </ul>	<ul style="list-style-type: none"> <li>• Do not soak knobs.</li> <li>• Do not force knobs onto wrong valve shaft.</li> </ul> <p style="text-align: right;">Continued <span style="float: right;">▶▶▶</span></p>

**SECTION SIX: CARE AND MAINTENANCE**

**COOKTOP CLEANING CHART**

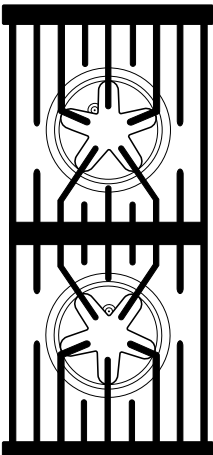
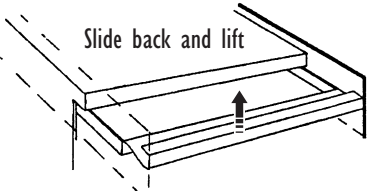
Cooktop Part / Material	Suggested Cleaners	Important Reminders
<p><b>Exterior Finish/Back Panel</b> Stainless Steel</p>	<ul style="list-style-type: none"> <li>• Nonabrasive Cleaners: Hot water and detergent, ammonia, Fantastic®, Formula 409®. Rinse and dry immediately.</li> <li>• Cleaner Polish: Stainless Steel Magic® to protect the finish from staining and pitting; enhances appearance.</li> <li>• Hard water spots: Household vinegar.</li> <li>• Mild Abrasive Cleaners: Siege Stainless Steel and Aluminum Cleaner, Kleen King® Stainless Steel liquid cleaner.</li> <li>• Heat discoloration: Cameo®, Barkeepers Friend®, Zud®.</li> </ul>	<ul style="list-style-type: none"> <li>• Stainless steel resists most food stains and pit marks providing the surface is kept clean and protected.</li> <li>• Never allow food stains or salt to remain on stainless steel for any length of time.</li> <li>• Rub lightly in the direction of polish lines.</li> <li>• Chlorine or chlorine compounds in some cleaners are corrosive to stainless steel. Check ingredients on label.</li> </ul>
<p><b>Grates:/Porcelain Enamel on Cast Iron</b></p> 	<ul style="list-style-type: none"> <li>• Nonabrasive cleaners: Hot water and detergent, Fantastic®, Formula 409®. Rinse and dry immediately.</li> <li>• Mild abrasive cleaners: Bon Ami® and Soft Scrub®.</li> <li>• Abrasive cleaners for stubborn stains: soap-filled steel wool pad.</li> </ul>	<ul style="list-style-type: none"> <li>• The grates are heavy; use care when lifting. Place on a protected surface.</li> <li>• Blisters/ crazing/ chips are common due to the extreme temperatures on grate fingers and rapid temperature changes.</li> <li>• Acidic and sugar-laden spills deteriorate the enamel. Remove soil immediately.</li> <li>• Abrasive cleaners, used too vigorously or too often can eventually mar the enamel.</li> </ul>
<p><b>Griddle Grease Tray/ Titanium Coated Aluminum</b></p> 	<ul style="list-style-type: none"> <li>• Clean the grease tray after each use.</li> <li>• May be placed in dishwasher.</li> <li>• Wash in detergent and hot water; rinse and dry.</li> <li>• Stubborn soil: Soft Scrub®</li> </ul>	<ul style="list-style-type: none"> <li>• Empty grease tray after each use.</li> <li>• Remove tray after grease has cooled. Be careful not to fill it so full that tipping to remove it spills the grease.</li> </ul>

**SECTION SIX: CARE AND MAINTENANCE**

**COOKTOP CLEANING CHART, continued**

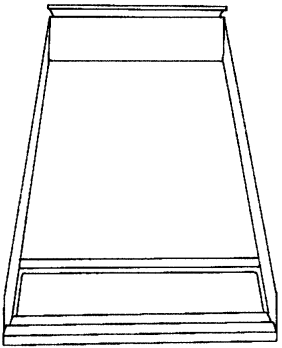
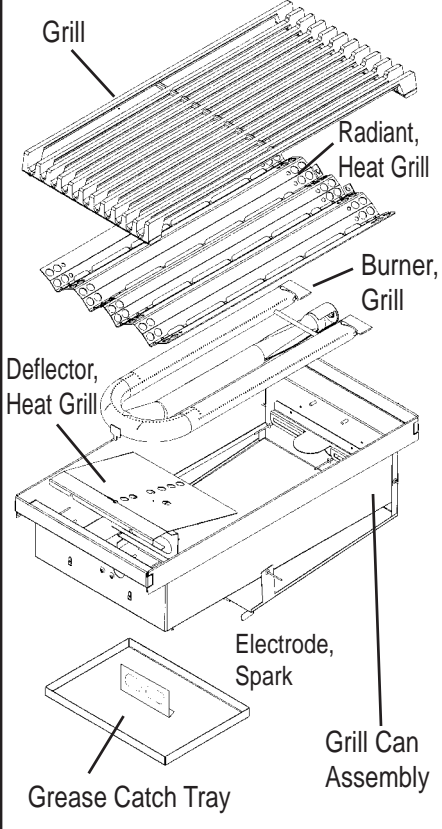
Cooktop Part / Material	Suggested Cleaners	Important Reminders
<p><b>Griddle/Titanium surfaced</b></p> 	<ul style="list-style-type: none"> <li>Remove drip tray and discard grease into a grease resistant container for disposal. Wash drip tray in warm soapy water or place in dishwasher. Wipe griddle surface with warm soapy water then rinse with warm water. Wipe dry with a soft cloth.</li> <li>If food particles stick to the griddle plate, remove with a mild abrasive cleaner such as Soft Scrub®.</li> </ul>	<ul style="list-style-type: none"> <li>Never flood a hot griddle with cold water. This can warp or crack the aluminum plate.</li> <li>Do not clean any part of the griddle in a self-cleaning oven.</li> </ul>
<p><b>Grill Box/Stainless Steel</b></p> 	<ul style="list-style-type: none"> <li><b>Non-abrasive Cleaners:</b> Hot water and detergent, ammonia, Fantastic®, Formula 409®. Rinse and dry immediately.</li> <li><b>Mild Abrasive Cleaners:</b> Bon Ami®, Soft Scrub®.</li> <li><b>Abrasive cleaners for stubborn stains:</b> soap-filled steel wool pad, Kleen King® Stainless Steel liquid cleaner.</li> </ul>	<ul style="list-style-type: none"> <li>Do not clean any part of the grill assembly in a self-cleaning oven.</li> <li>Abrasive cleaners, used too vigorously or too often, will eventually scratch the steel.</li> <li>When disassembling, cleaning and reassembling the grill, avoid contact with the spark igniter.</li> </ul> <div data-bbox="589 1608 1435 1740" style="border: 1px solid black; padding: 5px; margin-top: 10px;"> <p><b>Note:</b> To reach the grill box, remove the grate, stainless steel radiant, U-shaped burner, heat shield and drip pan.  <b>Note:</b> To disassemble or reassemble the grill box, see Page 20.</p> </div>

Continued



**SECTION SIX: CARE AND MAINTENANCE**

**COOKTOP CLEANING CHART, continued**

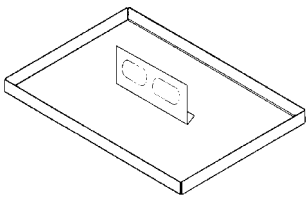
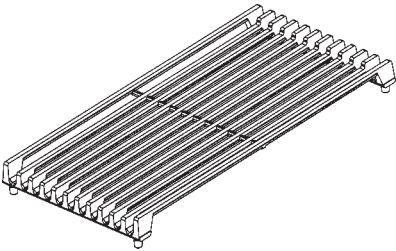
Cooktop Part / Material	Suggested Cleaners	Important Reminders
<p><b>Grill Drip Pan / Stainless Steel</b></p> 	<ul style="list-style-type: none"> <li>• Hot sudsy water; rinse and dry thoroughly.</li> <li>• After grease removal, drip pan may be put into dishwasher.</li> </ul>	<ul style="list-style-type: none"> <li>• Do not clean in a self-cleaning oven.</li> </ul>
<p><b>Grill Grate/Porcelain Enamel on Cast Iron</b></p> 	<ul style="list-style-type: none"> <li>• While the grate is hot (but the flame is off), dip a brass grill brush in hot water and scrub the grate. The steam created from the hot water and the abrasive action of the brush helps loosen the hard to remove soil.</li> </ul>	<ul style="list-style-type: none"> <li>• The grate is heavy; use care when lifting. Place on a protected surface.</li> <li>• Blisters, crazing and chips are common due to the extreme temperatures and rapid temperature changes.</li> </ul>
<p><b>Igniters/Ceramic</b></p>	<ul style="list-style-type: none"> <li>• Use a cotton swab dampened with water, Formula 409® or Fantastic®.</li> </ul>	<ul style="list-style-type: none"> <li>• Do not use sharp tool to scrape the igniter. It is fragile; if it is damaged the grill cannot be lit.</li> </ul>
<p><b>Surface Spill Trays/ Stainless Steel</b></p>	<ul style="list-style-type: none"> <li>• Hot sudsy water; rinse and dry thoroughly.</li> <li>• Formula 409® or Fantastic®. Wipe spray off immediately or apply to a paper towel first and then wipe spill.</li> <li>• Mild Abrasive Cleansers: Cameo®, Zud®, Barkeepers Friend®. Liquid cleaners: Kleen King®, Siege Stainless Steel and Aluminum Cleaner. Apply with care.</li> </ul>	<ul style="list-style-type: none"> <li>• Acidic and sugar-laden spills deteriorate the stainless steel. Remove soil immediately.</li> <li>• Abrasive cleaners, used too vigorously or too often, can eventually mar the stainless steel.</li> </ul>
<p><b>Trim Strips</b> (Located between stainless steel spill trays; they join the spill trays.)</p>	<ul style="list-style-type: none"> <li>• Hot sudsy water; rinse and dry thoroughly.</li> <li>• Formula 409® or Fantastic®. <b>Wipe spray off immediately or apply to a paper towel first and then wipe soil.</b></li> </ul>	<ul style="list-style-type: none"> <li>• The over-spray from liquid cleaners may leave an outline shadow. If allowed to dry, it may leave a permanent outline.</li> </ul>



# OVEN CLEANING CHART

Part/Material/Soil Condition	Cleaning Products/Directions
<p style="text-align: center;"><b>OVEN</b></p> <p><b>Broil Pan Grid</b>                      Chrome Plated                      Aluminum (12" oven)</p>	<p><b>DO NOT CLEAN IN SELF-CLEANING OVEN</b>                      To loosen cooked on food, sprinkle empty hot grid with powdered laundry detergent or squirt with liquid detergent and cover with wet paper towels. Allow to stand.</p> <p><b>Hot sudsy water.</b></p> <ul style="list-style-type: none"> <li>Wash, rinse thoroughly, and dry.</li> </ul> <p><b>Cleaners:</b> Soft Scrub®.</p> <ul style="list-style-type: none"> <li>Apply with a damp sponge or cloth according to manufacturer's directions. Rinse and wipe dry.</li> </ul> <p><b>Powdered Cleanser:</b> Bon-ami®, Comet®, Ajax®.</p> <ul style="list-style-type: none"> <li>Apply with a damp sponge or cloth according to manufacturer's directions. Rub lightly, it may scratch the finish. Rinse thoroughly and wipe dry.</li> </ul> <p><b>Soap-filled fiber or steel wool pads:</b> S.O.S®, Brillo®.</p> <ul style="list-style-type: none"> <li>Dampen pad, rub lightly, it may scratch the finish. Rinse thoroughly and wipe dry.</li> </ul>
<p><b>Broil Pan Bottom</b>                      Porcelain Enamel                      Aluminum (12" oven)</p>	<p>See instructions for <b>Cavity porcelain enamel. See instructions, above for broil pan grid.</b></p>
<p><b>Cavity</b>                      Porcelain Enamel on Steel</p>	<p>Porcelain enamel is acid resistant, but not acid proof. Acid foods such as citrus juices, tomatoes, rhubarb, vinegar, alcohol or milk, should be wiped up and not allowed to bake onto the porcelain during the next use. Over a period of time, the porcelain may craze (get fine hairlike lines).</p>
<p><b>Large Main Oven</b></p>	<p>See Self-Cleaning instructions, Pages 33 and 34.</p> <p><b>NOTE:</b> Due to the high temperatures used for self-cleaning, the oven may develop fine hairlike lines or surface roughness. This is a common condition and does not affect either the cooking or the cleaning performance of the oven.</p>
<p><b>12" Oven</b></p>	<p><b>Hot sudsy water.</b></p> <ul style="list-style-type: none"> <li>Wash, rinse thoroughly, and dry.</li> </ul> <p><b>Mild Cleaners:</b> Bon-ami®, ammonia, or ammonia and water, Soft Scrub®.</p> <ul style="list-style-type: none"> <li>Apply to a damp sponge or cloth. Rub lightly. Rinse thoroughly. Dry. If food has burned onto the oven and is difficult to remove, the spots can be soaked with a cloth saturated with household ammonia. Close the door and allow it to soak for an hour or two, or until the food soil can be easily removed with a damp soapy cloth or mild abrasive. A solution of about 3 tablespoons of household ammonia in a half cup of water may be placed in the warm oven over night. This will loosen hardened residue and spillage so that it may be easily wiped up. The ammonia solution may be added to warm water for a thorough wiping of the oven.</li> </ul> <p style="text-align: right;">Continued      ►►      ►►</p>

**SECTION SIX: CARE AND MAINTENANCE**

# RANGE CLEANING CHART

Part/Material/Soil Condition	Cleaning Products/Directions
<b>Front Frame</b> Stainless Steel	See <b>Cooktop</b> , Back Panel, Page 36.
<b>Oven Racks</b> Chrome Plated	<p><b>Racks may be cleaned in the oven during the clean cycle, however, they will lose their shiny finish and change to a dark, metallic gray.</b></p> <p><b>Hot sudsy water.</b></p> <ul style="list-style-type: none"> <li>Wash, rinse thoroughly, and dry.</li> </ul> <p><b>Cleaners:</b> Soft Scrub®.</p> <ul style="list-style-type: none"> <li>Apply with a damp sponge or cloth according to manufacturer's directions. Rinse and wipe dry.</li> </ul> <p><b>Powdered Cleanser:</b> Bon-ami®, Comet®, Ajax®.</p> <ul style="list-style-type: none"> <li>Apply with a damp sponge or cloth according to manufacturer's directions. Rub lightly. Rinse thoroughly and wipe dry.</li> </ul> <p><b>Soap filled fiber or steel wool pads:</b> S.O.S®, Brillo®.</p> <ul style="list-style-type: none"> <li>Dampen pad, rinse thoroughly, and dry.</li> </ul> <p><b>Harsh Cleaners:</b> Easy Off® Oven Cleaner, Dow® Oven Cleaner.</p> <p><b>NOTE:</b> Some commercial oven cleaners cause darkening and discoloration. Test the cleaner on a small part of the rack and check for discoloration before cleaning the entire rack.</p> <ul style="list-style-type: none"> <li>Apply a generous coating. Allow to stand for 10 to 15 minutes. Rinse thoroughly and wipe dry.</li> </ul> <p>If the racks do not slide easily after being cleaned, dampen a paper towel with a small amount of cooking oil and rub it lightly over the side rails.</p>
<div style="border: 1px solid black; border-radius: 10px; padding: 2px; display: inline-block; margin-bottom: 5px;"><b>DOOR</b></div> <b>Exterior, Frame, Handle, Heat Deflector</b> Stainless Steel	<p><b>Use care to keep cleaners and water away from the door vents. If water or cleaners spill into the vents, water may streak the glass inside.</b></p> <p>See <b>Cooktop</b>, Back Panel, Stainless Steel, Page 36.</p>
<b>Interior</b> Porcelain Enamel	See <b>Oven Cavity</b> , Page 39.
<b>Seal</b> Door Gasket	<p><b>General Kitchen Cleaners:</b> Formula 409®, Fantastik®.</p> <ul style="list-style-type: none"> <li>Spray on and blot dry with a cloth. Do not rub. Do not move, remove or damage mesh.</li> </ul>

## **DO-IT-YOURSELF MAINTENANCE**

### **OVEN LIGHT BULB REPLACEMENT**

Replace only with a 5-watt, halogen appliance light bulb. **DO NOT USE** a standard household light bulb in any oven.

#### **TO REPLACE THE LIGHT BULB:**

1. Turn oven light switch to the off position. Let bulb and cover cool completely.
2. Remove the light cover.
3. Remove the burned-out bulb. **Replace it with a 5-watt halogen appliance light bulb only. Don't touch bulb with greasy fingers. Follow bulb manufacturer's instructions.**
4. Replace cover. Turn circuit back on, if need be. (See Caution.)



#### **CAUTION:**

Before replacing the light bulb, be certain the **Oven Light Switch** is in the **off** position. Let bulb and cover cool completely before touching. **If the light bulb glass comes loose from the base, turn the power to the oven OFF at the circuit breaker panel, before attempting to remove the bulb base from the socket.**

### **POWER FAILURE**

In the event of a power failure, only the standard burners can be lighted manually. It is necessary to light each standard burner individually.

If the cooktop is being used when the power failure occurs, turn all of the burner control knobs to the **OFF** position. Then, the standard burners can be lighted by holding a match at the ports and turning the control knob to the **HI** position. Wait until the flame is burning all the

way around the burner cap before adjusting the flame to the desired height.

The two ExtraLow<sup>®</sup> burners on the far left side, cannot be used during a power failure. Be sure to turn them **OFF** if a power failure occurs, as they will not turn back on until both control knobs are turned **OFF** and then turned back on again. See "What to do if you Smell Gas", inside front cover.

If you have low gas pressure, contact your gas company.

### **INTERMITTENT OR CONSTANT IGNITER SPARKING**

Intermittent or constant sparking of the sealed gas surface burners can result from a number of preventable conditions. Eliminate these conditions as indicated in the chart.

<b>SYMPTOM</b>	<b>CAUSE</b>	<b>REMEDY</b>
Intermittent sparking	• Improper fit of burner cap onto burner base.	• Align burner cap properly on burner base.
	• Ceramic igniter is wet or dirty.	• Carefully dry or clean igniter.
	• Burner ports are clogged.	• Clean ports on flame spreader with a wire, a needle or straightened paper clip.
Constant Sparking	• Range is not properly grounded.	• Refer to Installation Instructions. Have a qualified electrician ground the range properly.
	• Electrical power supply is incorrectly polarized.	• Refer to Installation Instructions. Have a qualified electrician ground the range properly.

## **BEFORE CALLING FOR SERVICE**

**Before calling for Service, check the following to avoid unnecessary service charges.**

**Be sure to check these items first:**

Is there a power outage in the area?

Is the household fuse blown or the circuit breaker tripped?

Is the range disconnected from the electrical supply?

### **IF THE BURNERS DO NOT IGNITE**

- Are the burner caps properly aligned and seated in the burner base?
- Are the burner ports clogged?
- Is a fuse blown or is the circuit breaker tripped?
- Is the manual shut-off valve closed, preventing the flow of gas?

### **DATA RATING PLATE**

The data rating plate shows the model and serial number of your range. It is located behind the toe kick at the bottom of the range. To access the rating plate, remove the two toe kick attachment screws, then carefully remove the toe kick panel.

For all models, the data rating plate is found on the component tray behind the toe kick panel.

### **SERVICE INFORMATION**

For handy reference, copy the information below from the data rating plate. Keep your invoice for Warranty validation.

Model Number

Serial Number

Date of Purchase

Dealer's Name

Dealer's Phone Number

Service Center's Name

Service Center's Phone Number

Also, enter this information on the Product Registration Form included with this product, then mail it to the indicated address.



### **CAUTION:**

Before removing the toe kick panel, disconnect the range from the electrical power supply. Reinstall the toe kick panel before reconnecting the range to the power supply and operating the range.

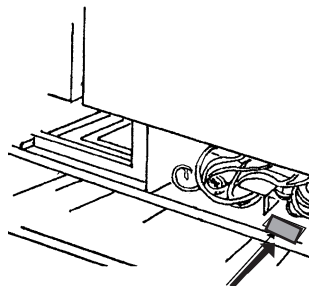

PGR Data Rating Plate Location

# WARRANTY

## FULL ONE YEAR WARRANTY

Covers one year from the date of installation or date of occupancy for a new previously unoccupied dwelling. Save your dated receipt or other evidence of the installation/occupancy date.

### Thermador® Will Pay For:

All repair labor and replacement parts found to be defective due to materials and workmanship.

Service must be provided by a Factory Authorized Service Agency during normal working hours.

For a Service Agency nearest you, please call 800/735-4328.

### THERMADOR® WILL NOT PAY FOR:

1. Service by an unauthorized agency. Damage or repairs due to service by an unauthorized agency or use of unauthorized parts.
2. Service visits to:
  - Teach you how to use the appliance.
  - Correct the installation. You are responsible for providing electrical wiring and other connecting facilities.
  - Reset circuit breakers or replace home fuses.
3. Damage caused from accident, alteration, misuse, abuse, improper installation or installation not in accordance with local electrical codes or plumbing codes, or improper storage of the appliance.

4. Repairs due to other than normal home use.
5. Service labor during limited warranty period.
6. Travel fees and associated charges incurred when the product is installed in a location with limited or restricted access, (i.e., airplane flights, ferry charges, isolated geographic regions).

Warranty applies to appliances used in residential application: it does not cover their use in commercial installations.

This warranty is for products purchased and retained in the 50 states of the U.S.A., the District of Columbia and Canada. Should the appliance be sold by the original purchaser during the warranty period, the new owner continues to be protected until the expiration date of the original purchaser's warranty period.

The warranty applies even if you should move. THERMADOR DOES NOT ASSUME ANY RESPONSIBILITY FOR INCIDENTAL OR CONSEQUENTIAL DAMAGES. Some states do not allow the exclusion or limitation of incidental or consequential damages, so the above limitation or exclusion may not apply to you. This warranty gives you specific legal rights and you may also have other rights which may vary from state to state or province to province.

## Notes

## Notes

Specifications are for planning purposes only. Refer to installation instructions and consult your countertop supplier prior to making counter opening. Consult with a heating and ventilating engineer for your specific ventilation requirements. For the most detailed information, refer to installation instructions accompanying product or write Thermador indicating model number.

We reserve the right to change specifications or design without notice. Some models are certified for use in Canada. Thermador is not responsible for products which are transported from the United States for use in Canada. Check with your local Canadian distributor or dealer.

For the most up to date critical installation dimensions by fax, use your fax handset and call 702/833-3600. Use code #8030.



***Thermador***®

5551 McFadden Avenue, Huntington Beach, CA 92649 • 800/735-4328  
ECO16588 • 5040008373 • © 2002 BSH Home Appliances Corp. • Litho in U.S.A. 10/02