

LIFE FITNESS CONSUMER DIVISION

14150 Sunfish Lake Blvd.
Ramsey Minnesota, 55303

U.S.A.

612.323.4500 • FAX: 612.323.4794
800.328.9714 (Toll-free within the U.S. and Canada)

INTERNATIONAL OFFICES

LIFE FITNESS CORPORATE HQ.

10601 W. Belmont Avenue
Franklin Park, Illinois 60131
U.S.A.
Tel: 847.288.3675
Fax: 847.288.3762
800.735.3867 (Toll-free in U.S./Canada)

LIFE FITNESS ASIA PACIFIC LTD

12th Floor, Tower 1, The Gateway
25 Canton Road
Tsimshatsui, Kowloon
HONG KONG
Tel: 011 852. 2. 891 6677
Fax: 011 852. 2. 575. 6001

LIFE FITNESS ATLANTIC BV

Atlantic Headquarters
Columbusstraat 25
3165 AC Rotterdam
THE NETHERLANDS
Tel: 011 31 10 294 5011
Fax: 011 31 10 294 5029

LIFE FITNESS DO BRAZIL

Brunswick Bowling and Billiards Ltda.
Alameda Rio Negro 433, Predio II 3
Andar, Sala 2
Alphaville Barueri
06454-904 Sao Paulo
BRAZIL
Tel: 055 11 7295 2217
Fax: 055 11 7295 2218

LIFE FITNESS AUSTRIA

Vertriebs Ges.mbH
Hirschgasse 1
1100 Vienna
AUSTRIA
Tel: 011 43. 1. 61 57 198
Fax: 011 43. 1. 61 57 198.20

LIFE FITNESS BENELUX NV

Lambrechtshekenlaan 309-311
B-2170 Antwerpen-Merksem
BELGIUM
Tel: 011 32 3 644 44 88
Fax: 011 32 3 644 24 80

LIFE FITNESS EUROPE GMBH

Siemensstrasse 3
85716 Unterschleissheim
GERMANY
Tel: 011 49. 89. 31 77 51.0
Fax: 011 49. 89. 31 77 51.99

LIFE FITNESS ITALIA S.R.L.

Via Vittorio Veneto 57
39042 Bressanone (BZ)
ITALY
Tel: 011 39. 0472. 835 470
Fax: 011 39. 0472. 833 150

LIFE FITNESS LATIN AMERICA

10601 West Belmont Avenue
Franklin Park, Illinois 60131
U.S.A.
Tel: 847.288.3675
Fax: 847.288.3762

LIFE FITNESS UK LTD

Queen Adelaide
Ely, Cambs CB7 4UB
UNITED KINGDOM
Tel: 011 44 1353-666017
Fax: 011 44 1353-666018

LIFE FITNESS JAPAN

Nippon Brunswick Bldg., #8F
5-27-7 Sendagaya
Shibuya-Ku, Tokyo 151-0051 Japan
Tel: 011 81- 3 - 3359 - 4309
Fax: 011 81- 3 - 3359 - 4307

6875301
03/00

Before using this product, it is essential to read this ENTIRE Operation Manual and ALL Assembly Instructions. They describe equipment setup and instruct users on how to use it correctly and safely.

Class H (Home): Domestic use.



CAUTION: Any changes or modifications to this equipment could void the product warranty.

An authorized service representative must perform any service, other than cleaning or user maintenance. There are no user serviceable parts.

TABLE OF CONTENTS

Section	Description	Page
1.	Getting Started	5
1.1	Important Safety Instructions	5
1.2	Set-up	7
	Electrical Power Requirements	
	Grounding Instructions	
	How to Stabilize the Life Fitness Treadmill	
	Power Switch	
	Centering the Belt	
2.	The Display Console	10
2.1	Display Console Overview	10
2.2	Display Console Descriptions	11
2.3	Reading Rack	12
2.4	Accessory Trays	12
3.	Heart Rate Zone Training [®] + Exercise	13
3.1	Why Heart Rate Zone Training Exercise	13
3.2	Heart Rate Monitoring	14
	The Polar [®] Heart Rate Chest Strap	
4.	The Workouts	15
4.1	Workout Descriptions	15
	Go System-Quick Start [™]	
	Zone Training [®] +	
	Fat Burn and Cardio	
	Heart Rate Hill and Heart Rate Interval	
	Extreme HR [™]	
	Sport Training, 5K Sport Training, and 10K Sport Training [™]	
	Hill	
	Random and Manual	
	EZ Incline [™]	
	Cool Down	
4.2	Using the Workouts (Chart)	21
4.3	Using My Workouts	22
	Introduction	
	Starting a Saved Workout	
	Saving a Workout and Changing Your User Name	
	Getting Your Statistics	
4.4	How to Maximize Workouts on a Life Fitness Treadmill	23
	Selecting the Correct Intensity Level	
5.	User Menu	24
5.1	Overview	24
5.2	Entering User Menu	24
5.3	Description of User Menu Items	24
	User Statistics	
	Settings	
	Software Version Numbers	
5.4	User Menu Items (Chart)	25
6.	Service and Technical Data	26
6.1	Preventive Maintenance Tips	26
6.2	Troubleshooting the Heart Rate Chest Strap	27
6.3	How to Adjust and Tension the Striding Belt on the Life Fitness Treadmill	28
	The Belt Tensioning Bolts	
	Tracking (Centering) an Existing or New Striding Belt	
	Tensioning an Existing Striding Belt	
6.4	How to Obtain Product Service	30
7.	Specifications	31
7.1	Life Fitness T3i Treadmill Specifications	31
7.2	Life Fitness T5i Treadmill Specifications	32

© 2000 Life Fitness, a division of Brunswick Corporation. All rights reserved. Life Fitness, FlexDeck and Heart Rate Zone Training are registered trademarks and Lifespring, Go System-Quick Start, Extreme HR, MagnaDrive, EZ Incline, Intelli, and 5K (and 10K) Sport Training are trademarks of Brunswick Corporation. Polar is a registered trademark of Polar Electro, Inc. Any use of these trademarks, without the express written consent of Life Fitness or the corresponding companies is forbidden.

This Operation Manual describes the functions of the following products:

Life Fitness Treadmill Models:

T3i

T5i

See "Specifications" in this manual for product specific features.

Statement of Purpose: The Treadmill is an exercise machine that enables users to walk or run, in place, on a moving surface.

Life Fitness **STRONGLY** recommends seeing a physician for a complete medical exam before undertaking an exercise program, particularly if the user has a family history of high blood pressure or heart disease, or is over the age of 45, or smokes, has high cholesterol, is obese, or has not exercised regularly in the past year.

If, at any time while exercising, the user experiences faintness, dizziness, pain, or shortness of breath, he or she must stop immediately.

Life Fitness conseille **VIVEMENT** de consulter un médecin pour suivre un examen médical complet avant de se lancer dans un programme d'exercice. Ceci concerne surtout les utilisateurs avec des antécédents familiaux de tension élevée ou d'affections cardiaques, les personnes de plus de 45 ans, les fumeurs et les obèses, ainsi que tous ceux qui ont un taux élevé de cholestérol ou qui n'ont pas fait d'exercice régulièrement depuis un an.

Si, à tout moment pendant l'exercice, l'utilisateur ressent un malaise, un étourdissement ou une douleur, ou s'il se trouve à bout de souffle, il doit s'arrêter immédiatement.

1 GETTING STARTED

1.1 IMPORTANT SAFETY INSTRUCTIONS

Read all instructions before using the treadmill.

DANGER: To reduce the risk of electrical shock, always unplug this Life Fitness product before cleaning or attempting any maintenance activity.

WARNING: To reduce the risk of burns, fire, electric shock or injury, it is imperative to connect each product to a properly grounded electrical outlet.

- To disconnect, turn power OFF at the ON/OFF switch, then remove plug from electrical outlet.
- Never operate a Life Fitness product if it has a damaged power cord or electrical plug, or if it has been dropped, damaged, or even partially immersed in water. Contact Life Fitness Customer Support Services.
- Position this product so the power cord plug is accessible to the user.
- Keep the power cord away from heated surfaces. Do not pull the equipment by the power cord or use the cord as a handle. Do not run the power cord on the floor, under or along the side of the treadmill.
- If the electrical supply cord is damaged it must be replaced by the manufacturer, an authorized service agent, or a similarly qualified person to avoid a hazard.
- Do not use this product in areas where aerosol spray products are being used or where oxygen is being administered. Such substances create the danger of combustion and explosion.
- Always follow the console instructions for proper operation.
- Close supervision is necessary when used by, or near children, invalids or disabled persons.
- Do not use this product outdoors, near swimming pools or in areas of high humidity.
- Never operate a Life Fitness product with the air openings blocked. Keep air openings free of lint, hair or any obstructing material.
- Never insert objects into any opening in this product. If an object should drop inside, turn off the power, unplug the power cord from the outlet and carefully retrieve it. If the item cannot be reached, contact Life Fitness Customer Support Services.
- Never place liquids of any type directly on the unit, except in an accessory tray or holder. Containers with lids are recommended.
- Wear shoes with rubber or high-traction soles. Do not use shoes with heels, leather soles, cleats or spikes. Make sure no stones are embedded in the soles. Do not use this product in bare feet. Keep all loose clothing, shoelaces and towels away from moving parts.
- Do not reach into or underneath the unit, or tip it on its side during operation.
- Keep the area six feet (2 meters) by three feet (1 meter) behind the treadmill clear of any obstructions, including walls, furniture, and other equipment.
- Handrails may be held to enhance stability as needed, but are not for continuous use.

- Use the handrails whenever additional stability is required. In case of an emergency, such as tripping, the handrails should be grabbed and the user should place his/her feet on the side platforms.
- Never walk or jog backwards on the treadmill.
- When necessary to immobilize the treadmill, set display to read SELECT A WORKOUT. (Press the STOP Key twice if not already there). Then hold down the SPEED DOWN Key and press the STOP Key. The treadmill now displays IMMOBILIZED. In this state, the treadmill cannot be operated. The main motor and incline are disabled. The treadmill will remain in this state across resets, power cycles, etc. To restore normal operation, repeat the same key sequence: hold down the SPEED DOWN Key and press the STOP Key. The treadmill will display SELECT A WORKOUT again.
- Use this appliance only for its intended use as described in this manual. Do not use attachments not recommended by the manufacturer.



CAUTION: Risk of injury to persons - To avoid injury, stand on the siderails before starting the treadmill.

WARNING: Activate software lockout when not in use. Refer to Owner's Manual for lockout instructions.
Store instructions out of reach of children.

SAVE THESE INSTRUCTIONS FOR FUTURE REFERENCE.

1.1 CONSIGNES DE SÉCURITÉ IMPORTANTES

Lire toutes les instructions avant d'utiliser le tapis roulant.

DANGER : Pour réduire les risques de décharge électrique, toujours débrancher cet appareil Life Fitness avant le nettoyage ou toute mesure d'entretien.

AVERTISSEMENT : Afin de réduire les risques de brûlures, d'incendie, d'électrocution ou de blessures, chaque appareil doit impérativement être branché sur une prise électrique correctement mise à la terre.

- Pour débrancher, mettre l'appareil hors tension au niveau de l'interrupteur d'alimentation, puis retirer la fiche de la prise électrique.
- Ne jamais faire fonctionner de produit Life Fitness avec une fiche ou un cordon d'alimentation endommagés, ni d'appareil qui serait tombé ou aurait été endommagé ou même partiellement plongé dans l'eau. Appeler le service clientèle de Life Fitness.
- Placer cet appareil de manière à ce que l'utilisateur puisse accéder à la fiche du cordon d'alimentation.
- Maintenir le cordon d'alimentation à l'écart de toute surface chauffée. Ne pas tirer l'appareil par son cordon d'alimentation ni utiliser le cordon comme poignée. Ne pas acheminer le cordon sur le plancher, sous le tapis roulant ou le long de l'appareil.
- Si le cordon électrique est endommagé, il doit être remplacé par le fabricant, par un réparateur agréé ou par une personne ayant une qualification équivalente, afin d'éviter les risques.
- Ce produit ne doit pas être utilisé dans des salles où des vaporisateurs aérosols sont employés ou bien où de l'oxygène est administré. De telles substances créent des risques de combustion et d'explosion.
- Les instructions de la console doivent toujours être suivies pour un fonctionnement correct.
- Une surveillance étroite est nécessaire en présence d'enfants, d'invalides ou de handicapés, ou lorsque l'appareil est utilisé par ces personnes.
- Ne pas utiliser ce produit à l'extérieur, près d'une piscine ou dans des endroits très humides.
- Ne jamais faire fonctionner d'appareil Life Fitness dont les orifices d'aération seraient bloqués. Maintenir les orifices d'aération exempts de peluches, de cheveux ou de tout type d'obstruction.
- Ne jamais rien insérer dans les ouvertures de cet appareil. Si un objet tombait à l'intérieur, le récupérer avec précaution après avoir mis la machine hors tension et débranché son cordon d'alimentation de la prise du secteur. S'il est impossible de l'atteindre, contacter le service clientèle de Life Fitness.
- Ne jamais placer de liquides quelconques directement sur l'appareil, sauf dans le plateau pour accessoires ou un support prévu à cet effet. Il est conseillé d'utiliser des conteneurs munis de couvercles.
- Porter des chaussures avec des semelles en caoutchouc ou fournissant une très bonne adhérence. Ne pas utiliser de chaussures à talons, de semelles en cuir ou de crampons. Vérifier si aucun caillou ne s'est incrusté dans les semelles. Ne pas utiliser cet appareil pieds nus. Maintenir les vêtements amples, les lacets de chaussures et les serviettes loin des parties mobiles.
- Ne rien essayer d'attraper dans ou sous l'appareil, et ne pas le renverser sur le côté pendant qu'il fonctionne.
- Derrière le tapis roulant, conserver une zone d'un mètre sur deux (3 x 6 pi) dégagée de toute obstruction, y compris murs, meubles ou autres appareils.

- Les rampes latérales peuvent servir à rétablir son équilibre, mais ne sont pas destinées à un usage continu.
- Utiliser les rampes latérales afin de ne pas perdre l'équilibre. En cas d'urgence, de perte d'équilibre par exemple, l'utilisateur doit saisir les mains courantes et placer ses pieds sur les plates-formes latérales.
- Ne jamais marcher ou courir en arrière sur le tapis roulant.
- Lorsqu'il est nécessaire d'immobiliser l'appareil, régler l'affichage sur SELECT A WORKOUT (Sélectionner un exercice). (Appuyer deux fois sur la touche STOP s'il n'y est pas déjà). Maintenir ensuite la touche SPEED DOWN (Ralentissement) enfoncée, et appuyer sur STOP. L'appareil affiche désormais IMMOBILIZED (Immobilisé). Il ne peut alors plus fonctionner, car le moteur principal et la pente sont désactivés. Le tapis roulant restera immobilisé, même s'il est réinitialisé, mis hors tension, puis à nouveau sous tension, etc. Le mode de fonctionnement normal ne peut être rétabli qu'au moyen de la même séquence de touches : maintenir la touche SPEED DOWN (Ralentissement) enfoncée et appuyer sur STOP. L'appareil affiche à nouveau SELECT A WORKOUT (Sélectionner un exercice).
- Cet appareil ne doit être employé que pour l'usage auquel il est destiné, conformément aux directives de son manuel. Ne pas utiliser d'accessoires non conseillés par le fabricant.



MISE EN GARDE : Risque de blessures - Afin d'éviter tout risque de blessure, se tenir debout sur les rails latéraux avant de démarrer l'appareil.

AVERTISSEMENT : Activer le verrouillage du logiciel lorsque l'appareil n'est pas utilisé. Se référer au manuel de l'utilisateur pour les instructions connexes. Stocker les instructions hors de portée des enfants.

1.2 SETUP

Read the Operation Manual before setting up the Life Fitness treadmill. Place the treadmill where it will be used before beginning the setup procedure.

1.2.1 ELECTRICAL POWER REQUIREMENTS

The Life Fitness treadmill is intended for use on a normal 120-Volt electrical circuit in the U.S. and Canada. The following table provides the current rating for this product based on supply voltage. Make sure this model supports the proper line voltage for your location before plugging the product into the receptacle.

Supply Voltage (VAC)	Frequency (Hz)	Maximum Current (Amps)
100	50 / 60	14.4
120	50 / 60	12
200	50 / 60	7.2
220	50 / 60	6.5
230	50 / 60	6.3
240+	50 / 60	6.0

1.2.2 GROUNDING INSTRUCTIONS

This Life Fitness product must be properly grounded. If the unit malfunctions or breaks down, proper grounding provides a path of least resistance for the electric current, which reduces the risk of shock to anyone touching or using the equipment. Each unit is equipped with an electrical cord, which includes an equipment grounding conductor and a grounding plug. The plug must be inserted into an outlet that has been properly installed and grounded in accordance with all local codes and ordinances.

A temporary adapter **MUST NOT BE USED** to connect this plug to a 2-pole receptacle in North America. If a properly grounded, 12 AMP outlet is not available, a qualified electrician must install one.

DANGER: A risk of electrical shock may result from improper connection of the equipment-grounding conductor. Check with a qualified electrician if in doubt about proper grounding technique. **DO NOT** modify the plug provided with the product. If it will not fit an electrical outlet, have a proper outlet installed by a qualified electrician.

DANGER : Tout branchement incorrect du conducteur de mise à la terre de l'appareil peut causer un risque de décharge électrique. Consulter un électricien qualifié en cas de doute sur la technique de mise à la masse. **NE PAS** modifier la fiche de l'appareil. Si elle ne s'adapte pas sur une prise électrique, faire installer une prise correcte par un électricien qualifié.

1.2.3 HOW TO STABILIZE THE LIFE FITNESS TREADMILL

After placing the unit where it will be used, check its stability. If there is even a slight rocking motion or the unit is not stable, determine which stabilizing leg is not resting on the floor. To adjust, loosen the JAM NUT (A) and turn the STABILIZING LEG (B) until the rocking motion ceases and both stabilizing legs rest firmly on the floor. Retighten the JAM NUT.

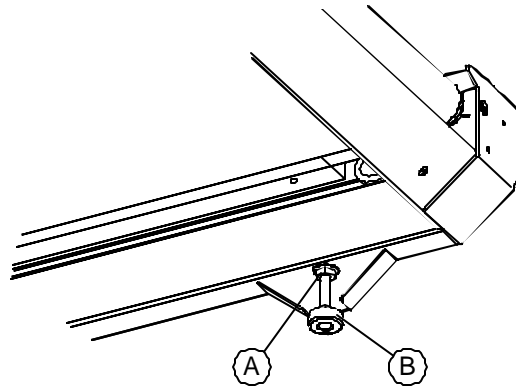

NOTE: *It is extremely important that the stabilizing leg be correctly adjusted for proper operation. An unbalanced unit may cause striding belt misalignment.*

1.2.4 POWER SWITCH

Located in the front of the product, the ON/OFF switch has two positions - "1" (one) for ON and "0" (zero) for OFF.

1.2.5 CENTERING THE BELT

After the treadmill has been installed and leveled, the belt must be checked to confirm proper tracking. First, plug the power cord into an appropriate outlet (see electrical requirements) and turn the treadmill ON.

Stand on the sides of the treadmill and straddle the belt, not standing on it at this time. Press the Go System-Quick Start Key and increase the speed to 4.0-mph (6,4 kph) using the Speed Up Arrow Key.

While the treadmill is running, if the striding belt moves to the right, turn the right tension bolt (A) 1/4 turn clockwise with provided 1/4" Allen wrench, and then turn the left tension bolt 1/4 turn counter-clockwise (see figure). This sets the striding belt tracking back to the center of the roller.

If the striding belt moves to the left, turn the left tension bolt 1/4 turn clockwise and then turn the right tension bolt 1/4 turn counter-clockwise to start striding belt tracking back to the center of the roller.

Repeat adjustments until the striding belt appears centered. The belt should be centered on the roller with an equal distance (B) *on both sides* from belt to roller. Allow the machine to continue running for several minutes to observe if tracking remains stabilized.

NOTE: *Do not exceed one full turn of the adjusting screws in either direction. If after one full turn the belt does not track properly, contact Customer Support Services. The phone numbers are listed in "How to Obtain Product Service."*

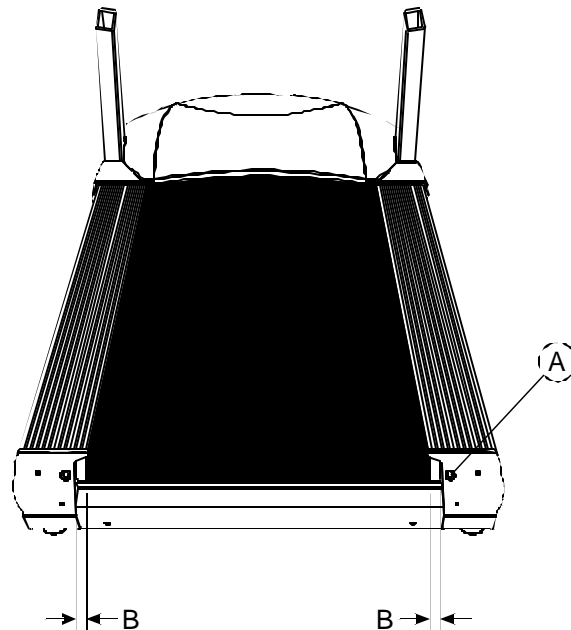

2 THE DISPLAY CONSOLE

2.1 DISPLAY CONSOLE OVERVIEW

The computerized display console is easy to use. It allows an individual to follow the progress of a workout. The on-board computer allows a workout to be tailored to individual fitness capabilities and goals while providing a unique means of measuring fitness improvement from one workout to the next.

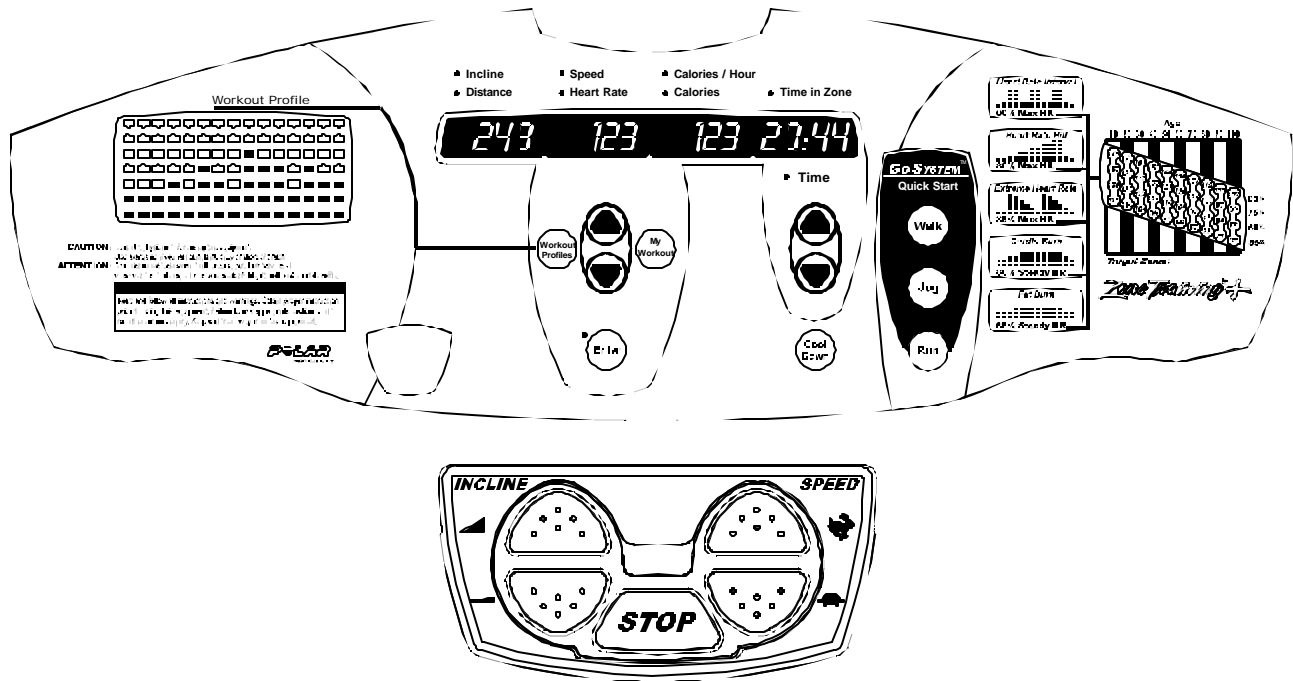

2.2 DISPLAY CONSOLE DESCRIPTIONS

- A. **WORKOUT PROFILE WINDOW:** Displays a matrix of LED lights displaying the current position and the upcoming terrain. While striding, the light columns move across the screen from right to left. The higher the column of lights, the greater the incline and workout intensity.
- B. **MESSAGE CENTER:** Provides simple step-by-step instructions and motivational messages. Displays Incline, Distance, Speed, Heart Rate, Calories/Hour, Calories, Time in Zone, and Time.

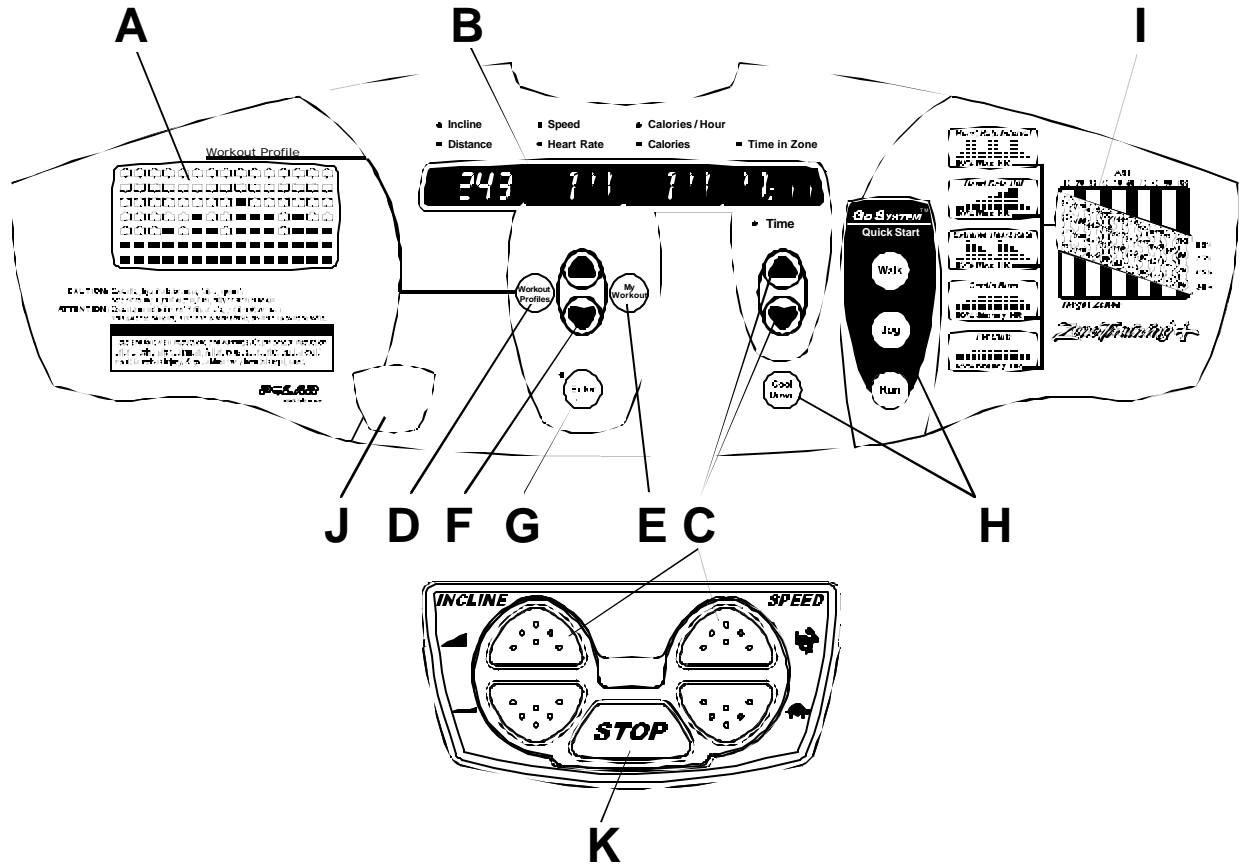

- C. **TIME, INCLINE AND SPEED KEYS:** Press these keys to increase or decrease the workout time, the incline of the treadmill deck, or the striding belt speed. In addition, any of these keys may be pressed to begin a workout or programming.
- D. **WORKOUT PROFILES:** Use to choose the Fat Burn, or Cardio Heart Rate Zone Training Workouts, in addition to Heart Rate Hill, Heart Rate Interval, Extreme HR, Sport Training, 5K (and 10K) Sport Training, Hill, Random, Manual, and EZ Incline Workouts.
- E. **MY WORKOUTS:** 4 programmable slots, which can be configured to any of your available workouts. My Workouts include the Fat Burn, Cardio, Heart Rate Hill, Heart Rate Interval, Extreme HR, Sport Training, 5K (and 10K) Sport Training, Hill, Random, Manual, and EZ Incline Workouts.
- F. **ARROW KEYS:** Allows you to make data entry, cycle through and select workouts, and change Target Heart Rate (THR) during Zone Training workouts.
- G. **ENTER KEY:** This key is used to enter the data displayed in the Message Center.
- H. **GO SYSTEM-QUICK START, COOL DOWN KEYS:**
 - GO SYSTEM-QUICK START: Allows you to quickly enter a Manual Workout with the press of a key.
 - COOL DOWN: Begins an automatically customized cool-down protocol.

I. ZONE TRAINING™ HEART RATE CHART

HEART RATE: Displays the user's heart rate while wearing a Polar® compatible heart rate chest strap.

TIME IN ZONE: Displays the accumulated time the heart rate stays within the selected zone – Fat Burn, Cardio, Heart Rate Hill, Heart Rate Interval, and Extreme HR. The selected Zone is based on your entered Target Heart Rate, and the workout selected.

J. EMERGENCY STOP SYSTEM: Pull the cord on this magnetized key to stop the striding belt on this treadmill.

1. Attach the clip to your clothing.
2. If Stop Key is pulled from the display console, the striding belt is stopped. Replace the key to reset the system.



K. STOP (PAUSE) KEY: Stops the belt, holds the current workout, and places the unit in PAUSE mode. Press twice in succession to terminate the workout. To resume your workout, press the Enter Key.

When in PAUSE mode a count down clock will be displayed. Once this clock times-out, the workout will terminate. You can override (reduce or extend the default PAUSE time presented to you) using the Time Arrow Keys. (See "Settings," in the User Menu for additional information on how to change default Pause time).



2.3 READING RACK

The Display Console design includes a built-in reading rack allowing a book or magazine to be supported during the workout.

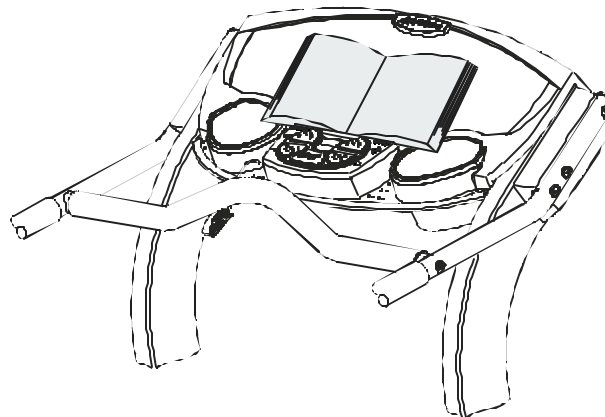

2.4 ACCESSORY TRAYS

The accessory trays are located on either side of the Display Console.

3 HEART RATE ZONE TRAINING® + EXERCISE

3.1 WHY HEART RATE ZONE TRAINING EXERCISE?

Research shows that exercising within a specific heart rate is the optimal way to monitor exercise intensity and achieve maximum results. That is the idea behind the Life Fitness Heart Rate Zone Training approach to exercise.

Zone Training Exercise takes the guesswork out of working out by identifying specific ranges, or zones, in which to maintain a heart rate to achieve maximum exercise results according to goals. In short, Zone Training Exercise all but eliminates under- and over-training by targeting the heart rate to individual fitness objectives.

For instance, if the primary goal is to burn fat, exercise at a level between 60% and 75% of the theoretical maximum heart rate†. Alternately, to improve cardiovascular condition, work out at 75% to 85% of the theoretical maximum heart rate.

Life Fitness offers five exclusive workouts designed to take full advantage of the benefits of Heart Rate Zone Training+ Exercise: Fat Burn, Cardio, Heart Rate Hill, Heart Rate Interval, and Extreme HR. The focus of the exercise activities can be varied by switching between the Zone Training workouts at any time during a workout by using the Workout Program Key.

All Zone Training workouts measure heart rate. Wear a telemetry heart rate chest strap and the heart rate will be transmitted to the on-board computer continuously. The elevation level will automatically adjust to maintain the target heart rate based on the actual heart rate.

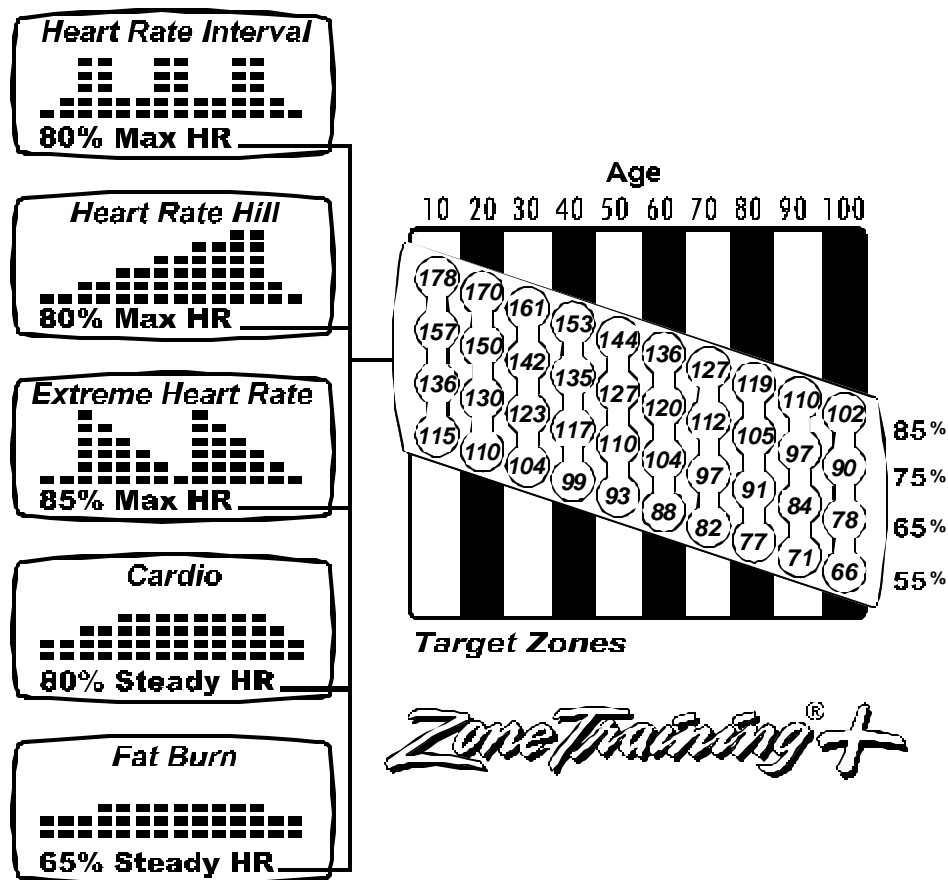

† Defined by the American College of Sports Medicine's "Guidelines for Exercise Testing and Prescription" as 220 minus age.

3.2 HEART RATE MONITORING

3.2.1 THE POLAR® HEART RATE CHEST STRAP

The standard Heart Rate Chest Strap allows the on-board, Polar® compatible, telemetry heart rate feature of this product to continuously monitor the heart rate and in many workouts adjusts aspects of the workout such as resistance level.

Wet the transmitter electrodes (A), the two grooved surfaces on the underside of the strap, and secure the strap as high under the chest muscles as possible. The strap should be snug, but comfortable enough to allow for normal breathing.

The transmitter strap will deliver an optimum heart rate reading when the electrodes are directly in contact with bare skin. However, it will function properly through wet, lightweight clothing.

The key to proper operation is for the electrodes to remain wet to transmit the electrical impulses of the heart back to the receiver.

If it becomes necessary to remoisten the chest strap electrodes, grasp the center of the strap, pull it away from the chest to expose the two electrodes, then moisten them in this position.

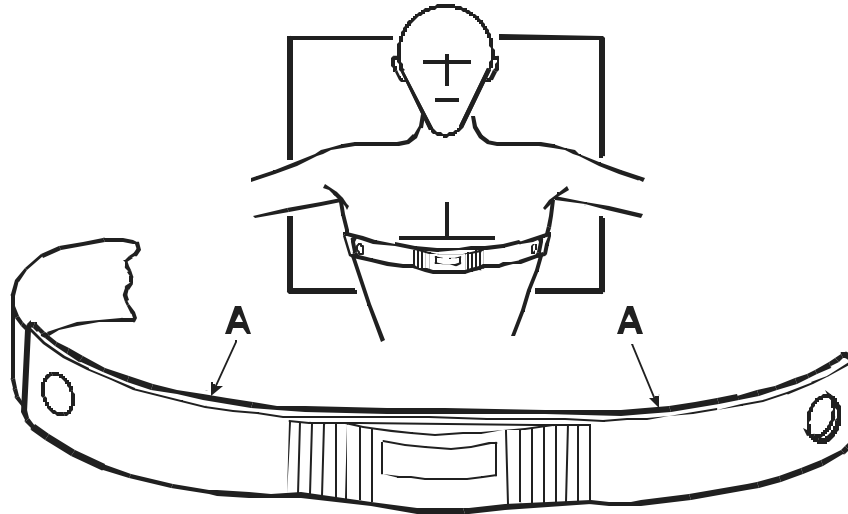

4 THE WORKOUTS

4.1 WORKOUT DESCRIPTIONS

Selecting a Life Fitness workout is as easy as pressing a key. The following are preprogrammed workouts for this Life Fitness product.

4.1.1 GO SYSTEM-QUICK START

GO SYSTEM-QUICK START™ is the fastest way to begin exercising, and allows you to start a Manual Workout by pressing a key. The corresponding keys allow you to enter a Manual Workout at a preset speed:

	English Units	Metric Units
• Walk	3.0 mph (0.5-4)	5,0 kph (0,8-6,5)
• Jog	5.0 mph (0.5-7)	8,0 kph (0,8-11,0)
• Run	7.0 mph (0.5-10/12)	11,0 kph (0,8-16/20)

Each workout can be reprogrammed to your desired speed. First, change the default values by adjusting the speed to a specified range using the Speed Arrow Keys. Then, hold down the Walk, Jog, or Run Key until the treadmill accepts the specific speed (by beeping 2 times). These keys can be reprogrammed at any time during the workout.

NOTE: *All adjusted presets erase when the treadmill is turned off.*

When the Walk, Jog, and Run Keys are used to select a particular speed within a workout program, the Message Center will show the new speed.

4.1.2 ZONE TRAINING^â + WORKOUTS

These workouts combine the effectiveness of Interval Training with the accuracy of Heart Rate Zone Training. A recommended workout heart rate is then calculated for you based on your age. You are shown this value and asked to accept or change it using the Arrow Keys and/or Enter Key. This value is used as the upper value of your workout zone. The lower value of this zone is automatically calculated based on which program you have selected. During the workout your Heart Rate Zone is tracked to see how long you stay in your zone. If your heart rate reaches or goes past your Theoretical Maximum for more than 45 seconds, the treadmill will automatically drop into PAUSE mode.

4.1.3 FAT BURN AND CARDIO WORKOUTS

FAT BURN WORKOUT

FAT BURN is a workout offering a low intensity way to burn fat. The Fat Burn Workout will automatically change the incline/resistance level to maintain the heart rate at 65% of theoretical maximum. The Fat Burn workout brings the benefits and results of Heart Rate Zone Training Exercise to you on a daily basis.

The Fat Burn Workout uses the technology of heart rate monitoring (via a heart rate chest strap) to help maintain a specific heart rate (65% of a theoretical maximum heart rate) within a target zone based on age, maximizing the aerobic benefits of exercise by accessing the body's fat stores for fuel.

The result is a perfect workout every time, eliminating both under and over-training. Concentration is centered on the workout, because the Life Fitness product responds to the heart rate and adjusts the incline/resistance level to maintain the target heart rate.

CARDIO WORKOUT

CARDIO is a higher intensity workout for more fit users, emphasizing cardiovascular benefits and maximum fat burning. The Cardio Workout will automatically change the incline/resistance level to maintain the heart rate at 80% of the theoretical maximum. This workout is virtually identical to the Fat Burn Workout. The only difference is that the target heart rate[†] is calculated at 80% of a theoretical maximum to accentuate cardiovascular improvement by placing a heavier workload on the heart muscle.

NOTE: You can change the target heart rate at any time during a workout by using the Arrow Keys.

4.1.4 HEART RATE HILL AND HEART RATE INTERVAL WORKOUTS

These workouts combine both the standard Hill Workout profiles with the Fat Burn and Cardio workout profiles. You are asked to enter your age as in standard Fat Burn and Cardio Heart Rate Workouts. A recommended workout heart rate is then calculated for you. You are shown this value and asked to accept or change it using the Arrow Keys and/or Enter Key. This value is used as the upper value of your workout zone. The lower values of this zone are automatically calculated based on which program you selected. During the workout your Heart Rate Zone is tracked to see how long you stay in your zone. If your heart rate reaches or goes past the Theoretical Maximum for more than 45 seconds, the unit will automatically drop into PAUSE mode.

HEART RATE HILL WORKOUT

HEART RATE HILL takes you through 3 intensity levels based on your target heart rate. This workout is similar to the standard heart rate program, except your Target Heart Rate goal varies. If you reach the first heart rate goal, then a new goal is set. This workout consists of 3 hills based on 3 heart rate goals: Hill #1 is 90% Target Heart Rate (THR). Hill #2 is 95% THR. Hill #3 is THR. The valley will always be defined as 85% of the THR.

The time, or duration you spend at a given heart rate goal is fixed at 1 minute once you reach your goal. If you don't reach the given goal, you won't encounter any other goals. Your fitness level determines the number of hills and valleys you encounter. Workout duration is based on time and thus can end during any Target Heart Rate goal.

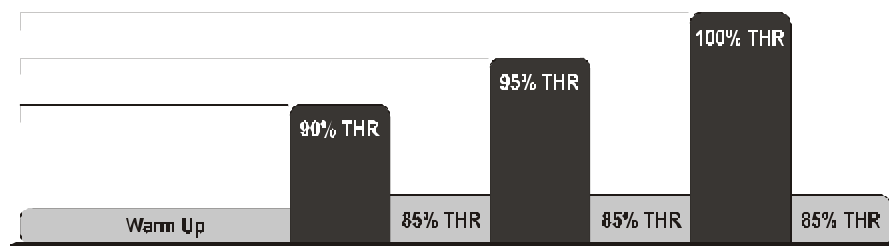

Heart Rate Hill Workout Profile

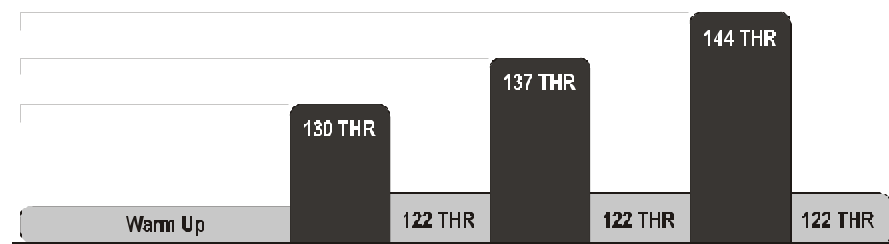

User Example (40 year old / 144 recommended THR)

[†] Defined by the American College of Sports Medicine's "Guidelines for Exercise Testing and Prescription" as 220 minus the age.

HEART RATE INTERVAL WORKOUT

HEART RATE INTERVAL Workout toggles you through 2 intensity levels based on your target heart rate. Duration of the hills and valleys is 3 minutes each, after you reach your current goal.

Your fitness level determines the number of hills and valleys you encounter. Once time is over, you go into Cool-Down mode. You will be prompted to reduce or increase your speed if the heart rate goal is not achieved after 5 minutes.

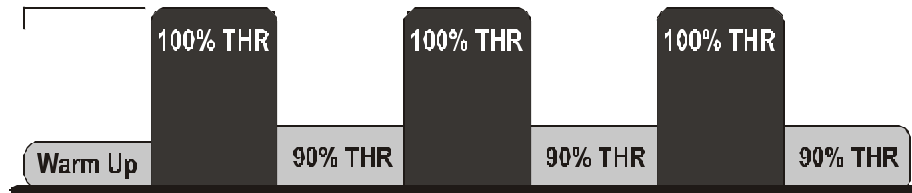

Heart Rate Interval Workout Profile

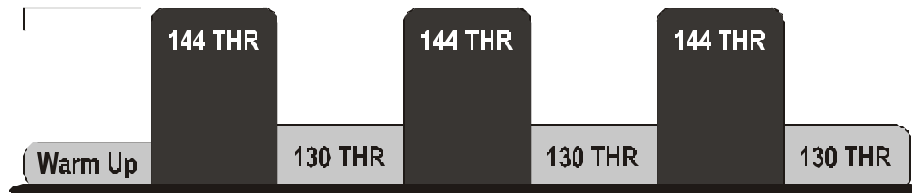

User Example (40 year old / 144 recommended THR)

4.1.5 EXTREME HR WORKOUT

EXTREME HR Workout is an intense workout for more experienced users. This workout is used to add variety to your workout and break through plateaus.

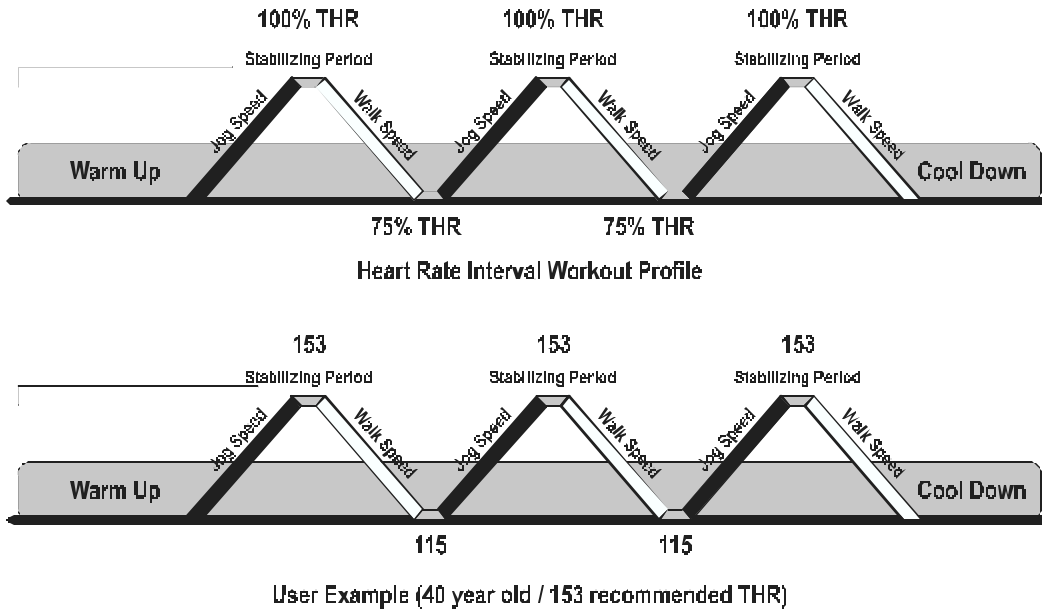

This workout raises and lowers your heart rate between two different goals. The objective is to get your heart rate up and down as quickly as possible, and is similar to running sprints.

You select a walk speed and a jog speed before starting the workout. Begin with a standard 3-minute warm up. After warm-up, the speed is ramped up to the selected jog speed and then incline is increased until the heart rate reaches Target Heart Rate (THR). Your heart rate is maintained at THR for a stabilizing period. Then the incline is reduced to 0% and the speed is ramped down to the walk speed. When your heart rate recovers to 75%THR, it is maintained at 75%THR for a stabilizing period. Then, the treadmill ramps the speed back up to the jogging speed. This will keep happening until your workout duration is reached.

4.1.6 SPORT TRAINING, 5K SPORT TRAINING, AND 10K SPORT TRAINING WORKOUTS

SPORT TRAINING WORKOUT

SPORT TRAINING Workout simulates conditions that a runner would experience when training in an outdoor environment. Baseline level is 1.5 percent (%) grade, which simulates flat running in an outdoor environment. Zero percent (%) simulates going downhill in an outdoor environment. Inclines last 30 to 60 seconds.

5K SPORT TRAINING WORKOUT

5K SPORT TRAINING Workout simulates conditions that a runner would experience when training for a 5-kilometer race. This workout is the same as Sport Training, but perfect for training for your 5K race/run. This workout will end after you have gone 5 kilometers(3.1 miles).

10K SPORT TRAINING WORKOUT

10K SPORT TRAINING Workout simulates conditions that a runner would experience when training for a 10 kilometer race. This workout is the same as Sport Training, but perfect for training for your 10K race/run. This workout will end after you have gone 10 kilometers(6.2 miles).

4.1.7 HILL WORKOUT

HILL is an interval-training workout consisting of a combination of hills and valleys proven to provide effective, time-efficient cardiovascular results. The Life Fitness patented Hill Workout offers the ideal configuration for interval training: periods of intense aerobic activity separated by regular intervals of lower-intensity exercise. The computerized interval training workout has been scientifically demonstrated to yield greater cardio-respiratory improvement than steady-pace training. Not only does the Hill Workout offer the challenge of alternating periods of high and low intensity, but the levels of intensity become progressively more difficult during the course of the workout. The longer the Hill Workout, the more time spent on top of a hill and at the bottom of a valley.

Effort and recovery periods are simulated on the Display Console by columns of red lights in the Workout Profile Window. The columns move from right to left during the workout. The higher the column, the higher the incline. Consequently, the effort must be increased to continue training.

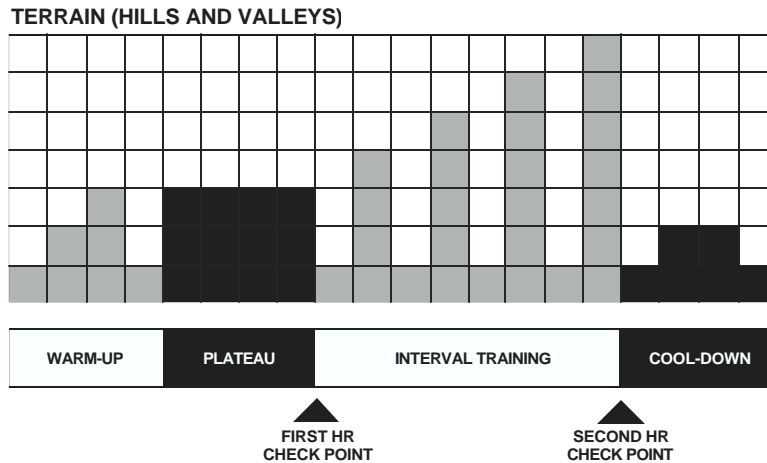

Each Hill workout session comprises the following phases:

(1) Warm-up, (2) Plateau, (3) Interval Training, and (4) Cool-down.

Warm-up: Gradually brings the heart rate into the lower portion of the target heart rate zone, increasing respiration and blood flow to working muscles.

Plateau: Increases heart rate so that it is within target zone. Check the heart rate at the end of the plateau period to ensure having entered the target heart rate zone.

Interval Training: A series of hills and valleys. During this portion of the workout, you are confronted with a series of successively steeper hills, each separated from the next by a valley or recovery period. Check the heart rate at the end of the interval training period to ensure staying within the target zone.

Cool-down: The cool-down allows the body to begin removing accumulated by-products of exercise, such as lactic acid, which build up in muscles during a workout and contribute to muscle soreness.

1 to 9 minutes: Because workouts with durations of less than 10 minutes are insufficient for the Hill Workout to complete all four phases adequately, the workout condenses at various stages to meet the chosen workout time.

10 to 19 minutes: The interval durations are initially set at 30 seconds for a 10-minute workout. For every additional minute of workout duration, the Hill Workout lengthens each interval by three seconds. Thus, a 15-minute Hill Workout will feature intervals of 45 seconds each.

20 to 99‡ minutes: All intervals last 60 seconds. As minutes are added, additional hills and valleys are presented beyond the initial four of the interval training phase. The additional hills and valleys will follow the form of the first four, dropping back down to the level of the very first hill encountered and progressing in height every two minutes until the highest hill is reached again. This process repeats until the workout duration is met.

‡ The treadmill is intermittent duty equipment. See Treadmill Specifications - Lift Motor: Maximum duty cycle of operation.

4.1.8 RANDOM AND MANUAL WORKOUTS

RANDOM WORKOUT

RANDOM is an interval-training workout of varying resistance levels, which occur randomly with each exercise session. The Life Fitness on-board computer randomly selects hill and valley terrain, which varies with each and every workout, resulting in more than one million combinations. Because workout levels are greater in this workout than in the Hill Workout, it is recommended that the Random Workout be set one or two levels lower than the workout level which would normally be selected in the Hill Workout.

MANUAL WORKOUT

MANUAL is a constant effort workout where you can change resistance level or speed at any time. The Manual Workout provides steady pace exercise with fixed speeds. The effort level is controlled by directly adjusting the speed and incline using the respective Arrow Keys.

A personal interval-training workout can be designed using the Manual Workout by varying the level of effort during the course of the workout session. To do so, select a high level of effort until the upper end of the target heart rate zone is reached, then select a lower effort level until the heart rate drops to the bottom of the target zone. Then increase the level of effort again until the heart rate rises back to the upper portion of the target zone. Repeating this process will actually create hills and valleys.

4.1.9 EZ INCLINE WORKOUT

EZ INCLINE Workout is an incline-based workout and it makes your workout more enjoyable. The gradual changes in elevation will go unnoticed, thereby lowering your perceived exertion, and resulting in a more enjoyable experience. You will get an effective and efficient cardiovascular workout without realizing how hard you're working to get it.

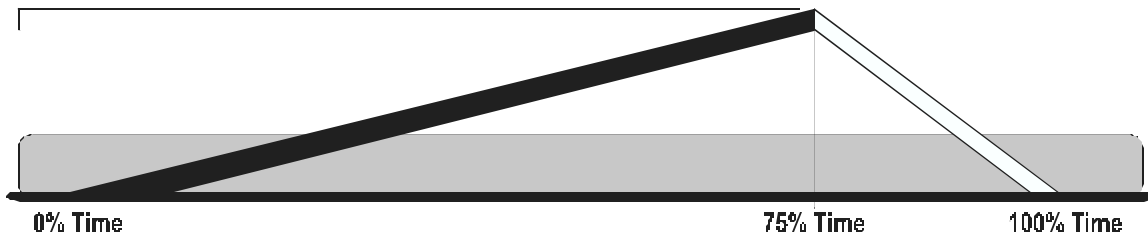

EZ Incline Workout Profile

You are presented with one hill. The peak of the hill is directly related to your chosen level. The peak will be reached after 75% of your workout duration, and then the incline will start moving back down to zero percent (%).

4.1.10 COOL-DOWN

Life Fitness' unique Cool-Down Protocol automatically customizes every cool-down based on your workout performance. Workout performance such as speed, incline, duration and heart rate are inputs in determining the duration and intensity of the cool-down.

4.2 USING THE WORKOUTS (CHART)

Select workout. Time, Incline, and Speed may be entered in any order using the Arrow Keys.

First, select a workout. The following charts explain the basic workout navigation. Use the specific workout key to select a workout. Use the Time, Incline, and Speed Arrows to enter data. The Time and Incline can be pre-entered prior to the workout selection by using the Arrow Keys. The chosen workout can be changed at any time. The display will prompt for any additional information that may be needed for the new workout. You can also change any of the workout parameters at any time during your workout.

GO SYSTEM-QUICK START™ Press Go System-Quick Start Walk, Jog, or Run Keys to enter a Quick Start workout at a specific speed.	10K SPORT TRAINING™ Enter weight Enter time Enter level Enter speed Begin workout
HILL Enter weight Enter time Enter level Enter speed Begin workout	FAT BURN Enter weight Enter time Enter age Enter Target Heart Rate† Enter speed Begin workout
RANDOM Enter weight Enter time Enter level Enter speed Begin workout	CARDIO Enter weight Enter time Enter age Enter Target Heart Rate† Enter speed Begin workout
MANUAL Enter weight Enter time Enter incline Enter speed Begin workout	HEART RATE HILL Enter weight Enter time Enter age Enter Target Heart Rate† Enter speed Begin workout
EZ INCLINE™ Enter weight Enter time Enter level Enter speed Begin workout	HEART RATE INTERVAL Enter weight Enter time Enter age Enter Target Heart Rate† Enter speed Begin workout
SPORT TRAINING™ Enter weight Enter time Enter level Enter speed Begin workout	EXTREME HR™ Enter weight Enter time Enter age Enter Target Heart Rate† Enter walk speed Enter jog speed Begin workout
5K SPORT TRAINING™ Enter weight Enter time Enter level Enter speed Begin workout	

† Or accept calculated value shown

4.3 USING MY WORKOUTS

4.3.1 INTRODUCTION

The My Workout Key is used to store and retrieve up to 4 different workouts. My Workouts include the Fat Burn, Cardio, Heart Rate Hill, Heart Rate Interval, Extreme HR, Sport Training, 5K (and 10K) Sport Training, Hill, Random, Manual, and EZ Incline Workouts.

4.3.2 STARTING A SAVED WORKOUT

To start, press the My Workout Key. Select the user name (using the My Workout and/or Arrow Keys), and then press Enter.

4.3.3 SAVING A WORKOUT AND CHANGING YOUR USER NAME

Use the following procedures to save, change, or edit a workout, or the name of the user.

TO PROGRAM, CHANGE A WORKOUT, OR EDIT A USER NAME:

1. Select the name of the user, using the My Workout Key and/or Arrow Keys.
2. Press and hold the Enter Key until it beeps 2 times. The Message Center will say, "PRESS WORKOUT PROGRAM KEY TO REPROGRAM WORKOUT OR MY WORKOUT KEY TO EDIT YOUR NAME".
3. Then, reprogram your workout or change your name using the instructions below.

TO REPROGRAM YOUR WORKOUT:

1. Press the Workout Program Key. The Message Center will say, "REPROGRAM WORKOUT MODE- SELECT WORKOUT NOW."
2. Press the Workout Program Key and/or use the Arrow Keys to select a workout.
3. Enter the rest of the requested data. Press Enter to save it. When it is stored, the message Center will say, "USER WORKOUT SAVED".
4. If you decide not to save the workout, press Stop twice to exit this mode.

TO CHANGE YOUR USER NAME:

1. Press the My Workout Key. The Message Center will say, "SELECT LETTER USING MY WORKOUT KEY AND CHANGE LETTERS USING ARROW KEYS."
2. Select the letter you want to change using the My Workout Key. This key will move you forward through the letters. Use the Workout Program Key to move backwards through the letters. The selected letter will be flashing.
3. Once you are on the letter you want to change, use the Arrow Keys to change it. You can select and change as many letters as you want.
4. Once you are finished editing your name press the Enter Key to save it. The Message Center will say, "USER NAME SAVED." If you decide not to save the name, press Stop twice to exit this mode.

4.3.4 GETTING YOUR STATISTICS (SEE THE SECTION, "DESCRIPTION OF USER MENU ITEMS")

The User Statistics mode is used to display the current accumulated statistics of up to 4 different users.

You can use the Time Up Arrow Key to move forward through the Statistics and use the Time Down Arrow Key to move backwards. If any data item is over the listed maximum you will see dashes in the display "----". These Statistics can be cleared to zero as follows: Press the Speed Up Arrow Key. The display will indicate "PRESS SPEED DOWN ARROW KEY TO CLEAR STATS". Press the Speed Down Arrow Key. The *stats* will be cleared and the message "STATS CLEAR" will be displayed. If you press any other key after pressing the Speed Up Arrow, it will cancel the clearing of the *stats*. Then, you must re-activate the clearing process by pressing the Speed Up Arrow Key again.

4.4 HOW TO MAXIMIZE WORKOUTS ON A LIFE FITNESS TREADMILL

4.4.1 SELECTING THE CORRECT INTENSITY LEVEL

In the Hill and Random Workouts, level refers to a range of hill inclines measured in percentages. The higher the level selected (between 1 and 20), the greater the average incline percentages.

LEVEL	% Incline	LEVEL	% Incline
1	0.0 - 1.0	11	0.0 - 11.0
2	0.0 - 2.0	12	0.0 - 12.0
3	0.0 - 3.0	13	0.0 - 13.0
4	0.0 - 4.0	14	0.0 - 14.0
5	0.0 - 5.0	15	0.0 - 15.0
6	0.0 - 6.0	16	1.0 - 15.0
7	0.0 - 7.0	17	2.0 - 15.0
8	0.0 - 8.0	18	3.0 - 15.0
9	0.0 - 9.0	19	4.0 - 15.0
10	0.0 - 10.0	20	5.0 - 15.0

There are seven possible hill incline percentages within the range for any level. The first hill height is represented by four lights per column in the Workout Profile Window, and each successive LED represents a higher hill. For example, in level 5, the lowest incline percentage for any hill is 0.0% (represented by one LED) and no hill will be higher than a 5.0% incline (all 7 LED's in the column will be lit). When the workout calls for a change in incline, the elevation will change in accordance with the level originally selected. A new level can be chosen at any time during any workout.

During EZ Incline Workout, the level chosen equals the height of the hill you will encounter. For example, at level 5, the peak of the hill will be at 5.0% incline (level 15 will present a 15% incline).

5 USER MENU

5.1 OVERVIEW

The T3i/T5i Consumer treadmills have a User Menu to vary specific attributes of the treadmill. Below are instructions on how to enter and use the menu.

5.2 ENTERING USER MENU

To enter the User Menu, press the Stop Key twice, and then hold down the Enter Key. The unit will go through a *warm* reset and beep 3 times. Alternately hold down the Enter Key, and turn the treadmill on. The message "USER MENU" will appear. After about 1 second the Console will automatically enter the first Menu Item.

Use the Enter Key to move forward through the Menu Items. Use the Stop Key to move backwards. When in the last mode, you must move backwards to get to the other items.

There are two ways to exit the menu: Turn off the treadmill (all settings will be saved). Or keep pressing the Stop Key to move all the way back to the beginning of the menu.

To see how to change settings in the menu, refer to the specific Menu Item below.

5.3 DESCRIPTION OF USER MENU ITEMS

5.3.1 USER STATISTICS

The User Statistics mode is used to display the current accumulated statistics of up to 4 different users. Select the user's name using the Up/Down Arrow Keys and/or My Workout Key. Press Enter. Use the Up/Down Arrow Keys to move through the data items. If any data item is over the listed maximum you will see dashes in the display "----". These Statistics can be cleared to zero as follows: Press the Speed Up Arrow Key. The display will indicate "PRESS SPEED DOWN ARROW KEY TO CLEAR STATS". Press the Speed Down Arrow Key. The *stats* will be cleared and the message "STATS CLEAR" will be displayed. If you press any other key after pressing the Speed Up Arrow, it will cancel the clearing of the *stats*. Then, you must re-activate the clearing process by pressing the Speed Up Arrow Key again.

5.3.2 SETTINGS

There are 3 Settings that can be adjusted and saved: Pause Time, Sleep Time, and Units. You can cycle through the settings using the Up/Down Arrow Keys. Use the Time Arrows to adjust the settings. Any adjustments are automatically saved. You can revert a setting back to its default value by pressing the Cool Down Key

5.3.3 SOFTWARE VERSION NUMBERS

SOFTWARE VERSION shows the current software version for the Console, and for the Motor Controller. Use the Up/Down Arrow Keys to toggle between them. The Console Software Version Number is displayed as "CONSOLE VER=XX.X" where xx.x is the version number. For the Motor Controller the message "MOTOR VER = XX.X" is displayed.

5.4 USER MENU ITEMS

SETTING	DEFAULT VALUE	RANGE	DESCRIPTION
USER STATISTICS			Mode displays accumulated statistics of up to 4 different users.
Select User			Use Arrow Keys to select 1 of 4 users. †
My Workout 1-4	MY WORKOUT X		Press Enter to access accumulated statistics of the selected user.
Statistics			
MILES:		XXXX:XX	Total accumulated distance- displayed in miles, and percentage of miles.
CALS:		XXXXXXX	Total accumulated workout calories.
TIME:		XXXX.XX	Total accumulated workout time- displayed in hours: minutes.
SETTINGS			Mode allows 3 settings to be adjusted and saved.
PAUSE TIME:	5	1-99	Default number of minutes you can pause a workout. You can override (reduce or extend PAUSE time) using the Time Arrow Keys during your workouts.
SLEEP TIME:	Off	Off-99	Without user activity, treadmill will go into Sleep Mode after a preset time(range is from 1 to 99 minutes). To conserve power, the Message Center and Workout Profile will go blank, except for a single indicator. To start a workout while in Sleep Mode, press any key. To disable, set to off.
UNITS:	English	English/ Metric	Sets the units of weight, speed and distance in English, or Metric.
SOFTWARE VERSION NUMBERS			Mode shows software version for Console and Motor Controller.
CONSOLE VER:		XX.X	Displays software version for the Console.
MOTOR VER:		XX.X	Displays software version for the Motor.

† If your name is already programmed, it will be displayed instead of "MY WORKOUT X."

6 SERVICE AND TECHNICAL DATA

6.1 PREVENTATIVE MAINTENANCE TIPS

The Life Fitness T-Series treadmill is backed by the engineering excellence and reliability of Life Fitness and is one of the most rugged and trouble-free pieces of exercise equipment on the market today. Commercial Life Fitness treadmills are among the most popular of aerobic trainers, regularly standing up to marathon use - 18 hours a day, 7 days a week - in health clubs, colleges and military facilities the world over. This same technology, engineering expertise, and reliability has gone into the Life Fitness T-Series treadmills.

NOTE: *Safety of the equipment can be maintained only if the equipment is examined regularly for damage or wear. Keep the equipment out of use until defective parts are repaired or replaced. Pay special attention to parts that are subject to wear, as outlined below.*

The following preventive maintenance tips will keep the Life Fitness treadmill operating at peak performance:

- Clean the display console and all exterior surfaces regularly with mild soap and water or a mild household cleaner. DO NOT use paper towels, ammonia or acid based cleaners. *
- Check operation of the Emergency Stop System once a week.
- Check the operation of the Stop Key once a week.
- Inspect and vacuum the area under unit regularly.
- Vacuum around the striding belt regularly to keep debris from accumulating.
- Inspect exterior parts regularly for wear, particularly the striding belt and deck.
- Check the position (centering) of the striding belt.

The optimum operating position of the striding belt is from 1.75" (45 mm) to 2.25" (57 mm) from either side of the frame. If the striding belt travels beyond this position, see "How to Adjust and Tension the Striding Belt" or contact **Life Fitness Customer Support Services** for proper alignment instructions, 1-800-328-9714 (USA).

***NOTE:** *When cleaning the exterior of the unit, a non-abrasive cleaner and soft cotton cloth are strongly recommended. At no time should cleaner be applied directly to any part of the equipment; use non-abrasive cleaner on a soft cloth and then wipe the unit.*

6.2 TROUBLESHOOTING THE HEART RATE CHEST STRAP

HEART RATE READING IS ERRATIC OR ABSENT ENTIRELY

- Repeat the electrode wetting procedure (see How to Use the Heart Rate Monitor Chest Strap). The electrodes must be wet to pick up and transmit accurate heart rate readings.
- Make sure the electrodes are flat against the skin.
- Wash the belt transmitter regularly with mild soap and water.
- Make sure the chest strap transmitter is within three feet (one meter) of the heart rate receiver.
- The chest strap is battery operated and will eventually stop functioning. If the chest strap transmitter battery is depleted, contact Life Fitness Customer Support Services at 1-800-328-9714 for instructions on how to have the chest strap replaced.

HEART RATE READING IS ERRATIC OR EXTREMELY HIGH

When exercising with the heart rate chest strap, you may come within range of electromagnetic signals strong enough to cause abnormally elevated heart rate readings. Possible sources of such signals include:

- Television sets and/or antennas, cell phones, computers, cars, high voltage power lines, and other motor driven equipment.
- Another heart rate transmitter within three feet (one meter) may also cause abnormal heart rate readings.

6.3 HOW TO ADJUST AND TENSION THE STRIDING BELT ON THE LIFE FITNESS TREADMILL

Do not move treadmill or place hands under treadmill while it is plugged into an electrical outlet!

Tool required: 5/16" hex key wrench

6.3.1 THE BELT TENSIONING BOLTS

The Life Fitness treadmill has access holes in the rear roller guards, which allow access to the tensioning bolts. These tensioning bolts make it possible to adjust tracking and centering of the striding belt (A) without removing the guards.

NOTE: *It is extremely important that the treadmill be correctly leveled prior to any tracking adjustments. An unstable unit may cause striding belt misalignment. See "How To Stabilize the Life Fitness Treadmill" in the "Set Up" section prior to attempting any rear roller adjustments.*

Before proceeding, it is helpful to visualize the REAR ROLLER (B) pivot point (C). Each adjustment made to one side of the ROLLER must be met with an equal and opposite adjustment (D) to the other side of the ROLLER to maintain an ideal belt tension at the pivot point.

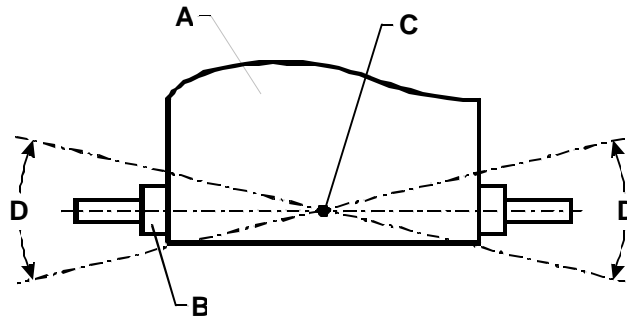

6.3.2 TRACKING (CENTERING) AN EXISTING OR NEW STRIDING BELT

- 1 Locate the two access holes to the belt tensioning bolts on each of the rear roller guards.
- 2 Stand on the sides of the treadmill and straddle the belt, not standing on it. Enter the Manual Workout and set the belt speed to run at 4.0 mph (6,4 kph).
- 3 If the striding belt has moved to the right, turn the right tension bolt 1/4 turn clockwise with provided 1/4" Allen wrench, and then turn the left tension bolt 1/4 turn counter-clockwise to start striding belt tracking back to center of roller.
- 4 If the striding belt has moved to the left, turn the left tension bolt 1/4 turn clockwise and then turn the right tension bolt 1/4 turn counter-clockwise to start striding belt tracking back to center of roller. Repeat adjustments until striding belt appears centered. Allow machine to continue running for several minutes to observe if tracking remains stabilized.

NOTE: *Do not exceed one full turn of the adjusting screws in either direction. If after one full turn the belt does not track properly, contact Customer Support Services. The phone numbers are listed in "How to Obtain Product Service."*

6.3.3 TENSIONING AN EXISTING STRIDING BELT

1 Enter the Manual Workout and run the treadmill for five minutes at 5.0 mph (8,0 kph).

NOTE: *Do not run on belt.*

2 Reduce the speed to 2.0-mph (3,2 kph). Walk on the treadmill, tightly grip the handrails and attempt to stall the striding belt. If the belt slips, continue to Step 3. If it does not slip, the tension is correct.

3 Using the Stop Key, stop the treadmill. Turn the belt tensioning bolts clockwise 1/4-turn per side to tension, do not exceed one full turn (four 1/4 turns per side).

4 Enter the Manual Workout and run the treadmill at 2.0-mph (3,2 kph) check to insure proper tracking. If the Striding Belt drifts to the left or right see "Tracking (Centering) an Existing or New Striding Belt" on the previous page.

NOTE: *Do not over tighten the tensioning bolts while making belt adjustments. Over tightening of bolts may over stretch and damage the striding belt or roller bearings. Do not exceed one full turn of either bolt in either direction.*

6.4 HOW TO OBTAIN PRODUCT SERVICE

1. Verify the symptom and review the operating instructions. The problem may be unfamiliarity with the product and its features and workouts.
2. Locate and document the serial number of the unit, which is located on the serial number plate above the power entry area.
3. Contact the nearest Life Fitness Customer Support Services Group:

TOLL-FREE WITHIN THE U.S. AND CANADA

Telephone: 800.328.9714

Telephone: 612.323.4500

FAX: 612.323.4794

For Product Service Internationally:

LIFE FITNESS EUROPE GMBH

Telephone: (+49). 89. 31 77 51.0

FAX: (+49). 89. 31 77 51.38

LIFE FITNESS (UK) LTD

Telephone: (+44) 1353-665507

FAX: (+44) 1353-666719

LIFE FITNESS BENELUX

Telephone: (+32) 3 644 44 88

FAX: (+32) 3 644 24 80

LIFE FITNESS ITALIA S.R.L.

Telephone: (+39). 0472. 835 470

FAX: (+39). 0472. 833 150

Life Fitness Austria Vertriebs GmbH

Telephone: (+43). 1. 61 57 198

FAX: (+43). 1. 61 57 198. 20

LIFE FITNESS ASIA PACIFIC LTD

Telephone: 852. 2575.6262

FAX: 852. 2. 575. 6001

LIFE FITNESS LATIN AMERICA

Telephone: (+1).847.288.3675

FAX: (+1).847.288.3762

LIFE FITNESS BRAZIL

Telephone: 055 11 7266 5210

FAX: 055 11 7295 2218

LIFE FITNESS ROTTERDAM

Telephone: 31 10 294 5011

FAX: 3110 294 5029

LIFE FITNESS JAPAN

Telephone: 81-3 - 3359 - 4309

FAX: 81- 3 - 3359 - 4306

7 SPECIFICATIONS

7.1 LIFE FITNESS T3i TREADMILL SPECIFICATIONS

Designed use:	Consumer	
Maximum user weight:	300 pounds / 135 kilograms	
Speed range:	0.5 - 10.0 mph (0,8 – 16 kph) in 0.1 increments	
Elevation range:	0%-15% (in 0.5% increments)	
Motor:	2.3 HP continuous duty DC	
Lift Motor:	Maximum duty cycle of operation is 1 minute on, 5 minutes off	
Rollers:	2.0" precision crowned	
Belt:	54" Length x 20" Width (137 cm Length x 51 cm Width), multi-ply	
Deck:	Wax laminate, cushioned, not reversible	
Handrails:	Straight crossbar only 1.25" (Optional handrails)	
Workouts:	Fat Burn, Cardio, Heart Rate Hill, Heart Rate Interval, Extreme HR, Sport Training, 5K (and 10K) Sport Training, Hill, Random, Manual, and EZ Incline Workouts	
Levels:	20 levels each: in Sport Training, 5K (and 10K) Sport Training, Hill, Random, and EZ Incline Workouts	
Telemetry HR monitoring:	Standard (Polar HR monitoring system)	
Accessory tray:	Standard- designed into system	
Console style:	Deluxe	
Profile window:	7x15	
Display:	16 character red LED Message Center	
Warranty:	3 years parts, 1-year labor, and lifetime on frame and life spring	
Physical Dimensions:		
Length:	72.5 inches / 184 centimeters	
Width:	32.25 inches / 82 centimeters	
Height:	55.5 inches / 141 centimeters	
Weight:	220 pounds / 100 kilograms	
Shipping Dimensions:		
	Base Carton	Console Carton
Length:	82.0 inches / 208.3 centimeters	30.6 inches / 77.7 centimeters
Width:	33.0 inches / 83.4 centimeters	14.9 inches / 37.9 centimeters
Height:	18.5 inches / 47.0 centimeters	7.7 inches / 19.6 centimeters
Weight:	230 pounds / 104,3 kilograms	16.5 pounds / 7,5 kilograms

7.2 LIFE FITNESS T5i TREADMILL SPECIFICATIONS

Designed use:	Consumer	
Maximum user weight:	400 pounds / 180 kilograms	
Speed range:	0.5 - 12.0 mph (0,8 - 20 kph) in 0.1 increments	
Elevation range:	0%-15% (in 0.5% increments)	
Motor:	2.7 HP continuous duty DC	
Lift Motor:	Maximum duty cycle of operation is 1 minute on, 5 minutes off	
Rollers:	2.0" precision crowned	
Belt:	58" Length x 20" Width (147 cm Length x 51 cm Width), multi-ply	
Deck:	Wax laminate, cushioned, not reversible	
Handrails:	Ergo Crossbar with side handrails 1.25"	
Workouts:	Fat Burn, Cardio, Heart Rate Hill, Heart Rate Interval, Extreme HR, Sport Training, 5K (and 10K) Sport Training, Hill, Random, Manual, and EZ Incline Workouts	
Levels:	20 levels each: in Sport Training, 5K (and 10K) Sport Training, Hill, Random, and EZ Incline Workouts	
Telemetry HR monitoring:	Standard (Polar HR monitoring system)	
Accessory tray:	Standard- designed into system	
Console style:	Deluxe	
Profile window:	7x15	
Display:	16 character red LED Message Center	
Warranty:	3 years parts, 1-year labor, and lifetime on frame and life spring	
Physical Dimensions:		
Length:	76.5 inches / 194 centimeters	
Width:	32.5 inches / 82 centimeters	
Height:	55.5 inches / 141 centimeters	
Weight:	253 pounds / 115 kilograms	
Shipping Dimensions:		
	Base Carton	Console Carton
Length:	82.0 inches / 208.3 centimeters	30.6 inches / 77.7 centimeters
Width:	33.0 inches / 83.8 centimeters	14.9 inches / 37.9 centimeters
Height:	18.5 inches / 47.0 centimeters	7.7 inches / 19.6 centimeters
Weight:	275 pounds / 124,7 kilograms	16.5 pounds / 7,5 kilograms