



# Canister Vacuum Cleaner

Household Type

## Owner's Guide

### S3530 Series



#### INDEX

Important Safeguards .....	2
Service Information .....	4
Thermal Cut Off .....	4
Assembly .....	5
How to Use .....	6
Accessories .....	7
Maintaining .....	8
Dust Bag .....	8
Filters .....	9
Problem Solving .....	10
Warranty .....	11-12
Order Form .....	Center of Book

# IMPORTANT SAFEGUARDS

When using an electric appliance, basic precautions should always be followed, including the following:

**READ ALL INSTRUCTIONS BEFORE USING THIS VACUUM CLEANER.**

## WARNING

To reduce the risk of fire, electric shock, or injury:

- Do not use outdoors or on wet surfaces.
- **Do not leave vacuum cleaner when plugged in.** Turn off the switch and unplug the electrical cord when not in use and before servicing.
- Do not allow to be used as a toy. Close attention is necessary when used by or near children.
- Use only as described in this manual. Use only manufacturer's recommended attachments.
- Do not use with damaged cord or plug. If vacuum cleaner is not working as it should, has been dropped, damaged, left outdoors, or dropped into water, return it to a service center before using.
- Do not pull or carry by cord, use cord as a handle, close a door on cord, or pull cord around sharp edges or corners. Do not run vacuum cleaner over cord. Keep cord away from heated surfaces.
- Do not use extension cords or outlets with inadequate current carrying capacity.
- Turn off all controls before unplugging.
- Do not unplug by pulling on cord. To unplug, grasp the plug, not the cord.
- Do not handle plug or vacuum cleaner with wet hands or operate without shoes.
- Hold plug when rewinding onto cord reel. **DO NOT** allow plug to whip when rewinding.
- Do not put any object into openings. Do not use with any opening blocked; keep free of dust, lint, hair, and anything that may reduce airflow.
- This vacuum cleaner creates suction. Keep hair, loose clothing, fingers, and all parts of body away from openings and moving parts.
- Do not pick up anything that is burning or smoking, such as cigarettes, matches, or hot ashes.
- Do not use without dust bag or filter(s) in place.
- Use extra care when cleaning on stairs.
- Do not pick up flammable or combustible liquids such as gasoline, or use in areas where they may be present.
- Store your cleaner indoors in a cool, dry area.
- Keep your work area well lighted.
- Unplug electrical appliances before vacuuming them.

## SAVE THESE INSTRUCTIONS

# CONSEILS DE SÉCURITÉ

Lors de l'utilisation d'un appareil électrique, quelques précautions élémentaires doivent être observées, incluant les suivantes:

**LISEZ TOUTES LES INSTRUCTIONS AVANT D'UTILISER VOTRE ASPIRATEUR.**

## AVERTISSEMENT

Pour réduire le risque de feu, de choc électrique ou de blessure:

- Ne pas utiliser l'aspirateur à l'extérieur ou sur une surface mouillée.
- **Ne pas laisser l'aspirateur seul quand il est branché.** Mettre l'interrupteur sur arrêt et débrancher l'appareil lorsque vous ne l'utilisez pas ou avant l'entretien.
- Ne pas permettre que l'aspirateur soit utilisé comme un jouet. Une attention particulière est nécessaire lorsqu'il est utilisé par ou près d'un enfant.
- Suivre strictement les recommandations d'utilisation de ce manuel. Utiliser uniquement les accessoires recommandés par le fabricant.
- Ne jamais utiliser l'aspirateur si le cordon ou la fiche sont endommagés. Si l'aspirateur ne fonctionne pas comme il le devrait, s'il a été échappé, s'il est endommagé, s'il a été laissé à l'extérieur ou échappé dans de l'eau, le retourner à un centre de service avant de l'utiliser.
- Ne pas l'aspirateur ou le transporter par le cordon. Ne pas utiliser le cordon en guise de poignée. Ne pas fermer une porte sur le cordon ou tirer le cordon sur des bordures ou des coins pointus. Ne pas passer l'aspirateur sur le cordon. Tenir le cordon à distance des surfaces chauffantes.
- Ne pas utiliser des cordons de rallonge ou des prises qui n'ont pas une capacité suffisante pour transporter le courant.
- Mettre sur arrêt tous les boutons de commande avant de débrancher.
- Ne pas débrancher l'aspirateur en tirant sur le cordon. Pour débrancher saisir la fiche et non pas le cordon.
- Ne pas manipuler la fiche ou l'aspirateur les mains mouillées ou faire fonctionner pieds nus.
- Tenez la fiche à la main lorsque vous embobinez le cordon. Ne permettez pas que la fiche batte l'air.
- Ne rien insérer dans les ouvertures. Ne pas utiliser l'aspirateur si des ouvertures sont bloquées. Vous assurer qu'elles soient dégagées de poussière, de mousse, de cheveux ou de tout autre chose qui pourrait réduire le passage de l'air.
- Cet aspirateur crée de la succion. Tenir les parties mobiles et les ouvertures loin des cheveux, du linge, des doigts et de toute partie du corps.
- Ne pas ramasser des objets qui brûlent ou fument comme les cigarettes, les allumettes ou les cendres chaudes.
- Ne pas utiliser sans que le sac à poussière ou le(s) filtre(s) ne soient en place.
- Porter une attention particulière lorsque vous nettoyez les escaliers.
- Ne pas utiliser pour ramasser des liquides inflammables ou combustibles, comme de l'essence. Ne pas utiliser dans les endroits où ces liquides pourraient être présents.
- Entreposer votre aspirateur à l'intérieur, dans un endroit propre et sec.
- Maintenir un bon éclairage à l'endroit où vous travaillez.
- Débrancher les appareils électriques avant de les passer à l'aspirateur.

## CONSERVEZ CES INSTRUCTIONS

**To reduce the risk of electric shock**, this appliance has a polarized plug (one blade is wider than the other). This plug will fit in a polarized outlet only one way. If the plug does not fit fully into the outlet, reverse the plug. If it still does not fit, contact a qualified electrician to install the proper outlet. Do not change the plug in any way.

**Afin de réduire le risque de choc électrique**, cet appareil est muni d'une fiche polarisée (une des lames est plus large). Cette fiche ne peut être insérée dans une prise polarisée que d'une seule façon. Si la fiche ne peut être insérée dans la prise, retourner la fiche. Si la fiche ne peut toujours pas être insérée dans la prise, faire installer une prise adéquate par un électricien qualifié. Ne pas modifier la fiche.

## GENERAL INFORMATION

The cleaner is designed to pick up dirt and dust particles. Avoid picking up hard or sharp objects with the cleaner to avoid bag breakage, hose clogging, or possible motor damage.

## Service Information

The instructions in this booklet serve as a guide to routine maintenance. For additional service information telephone our toll free number for the nearest Eureka Authorized Warranty Station. **You should know the model, type and serial numbers when you call:**

**USA: 1-800-282-2886**

**Mexico: 5670-6169**

**Canada: 1-800-282-2886**

If you prefer, you can write to The Eureka Company, Service Division, 807 N. Main Street, Bloomington, Illinois 61701, USA. In Canada write to The Eureka Company, 866 Langs Drive, Cambridge, Ontario N3H 2N7. Refer to The Eureka Warranty for complete service information.



**DO NOT OIL the motor at any time. The bearings are permanently lubricated and sealed.**

## Rating Plate

The model, type, and serial numbers are indicated on the rating plate located on the underneath side of the cleaner. For prompt and complete service information, always refer to these numbers when inquiring about service.

MODEL	TYPE	SERIAL NO.
VOLTS	AMPS.	HERTZ
SERVICE INFORMATION: 1-800-282-2886		
<b>THE EUREKA COMPANY</b>		
BLOOMINGTON, ILLINOIS 61701		

**Model & Type** \_\_\_\_\_ **Serial No.** \_\_\_\_\_

## Thermal Cut Off

This cleaner has a special thermostat that protects the cleaner in case of motor overheating. If the cleaner suddenly turns off, follow this procedure:

1. Push the on/off button to the off position.
2. Unplug cleaner.
3. Check for source of overheating problem (i.e. full bag, clogged hose or clogged filter).
4. If a full bag, clogged hose or clogged filter is found, replace the bag, unclog the hose or replace the filters.
5. Wait at least 30 minutes before attempting to reuse the cleaner.
6. After 30 minute cool down period, plug the cleaner in and push on/off button. The cleaner should turn on.
7. If the cleaner still does not operate, take it to any Eureka Authorized Service Center for repair.

## TO ASSEMBLE

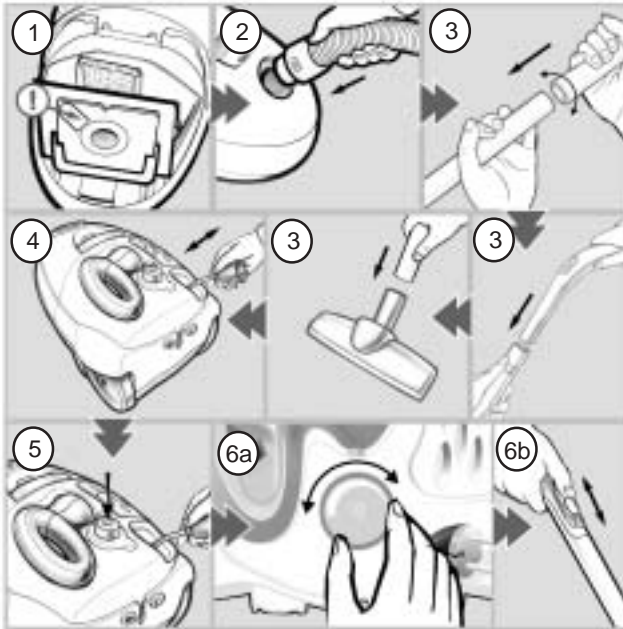

1. Check to see if the dust bag is in place, the bag lid will not close without a bag in place.
2. Insert the hose into unit until it locks into place.
3. Attach wands to the hose handle and floor nozzle by pushing and twisting together.
4. Pull the electrical cord out from unit and plug into electrical socket. (On some models.)
5. Press On/Off button to start cleaner.
- 6a. To decrease/increase suction, rotate the On/Off button. (On some models.)
- 6b. To decrease/increase suction push up or down on valve.

## How To Use

A carpet should be cleaned regularly over heavily traveled areas, and once a week over the entire carpeted area. Vacuum slowly, making several passes (forward and backward) over the carpet, covering small areas at a time. The time required to clean the carpet will depend on several factors-including type of carpet and amount of dirt.

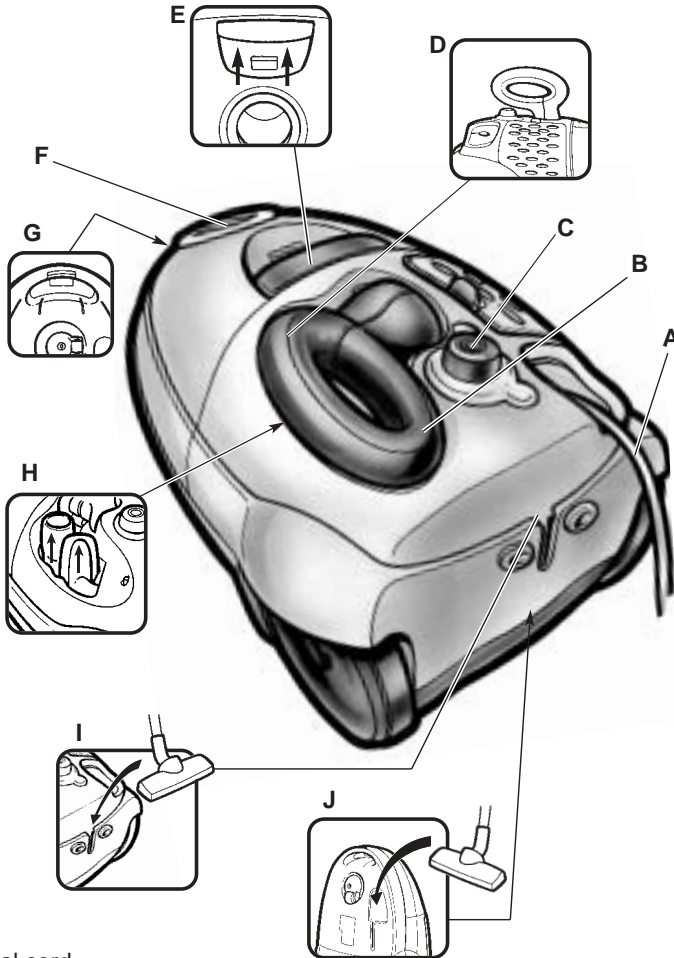

- A. Electrical cord.
- B. Electrical cord rewind button. The rewind button is under the multifunction handle. Press down on the multifunction handle while in storage position to activate rewind button. (For models with cord reel.)
- C. Push for On/Off button and rotate for suction control. (For models with speed control.)
- D. Multifunction handle.
- E. Cover release for dust bag compartment.
- F. Hose connection.
- G. Carrying Handle
- H. Accessory storage compartment. Holds crevice tool and upholstery tool. (Located under multifunction handle.)
- I. Storage slot for floor nozzle and extension wands when not in use.
- J. Storage slot for floor nozzle and extension wands when in use.

# Cleaning Accessories

Attach wands and cleaning tools.

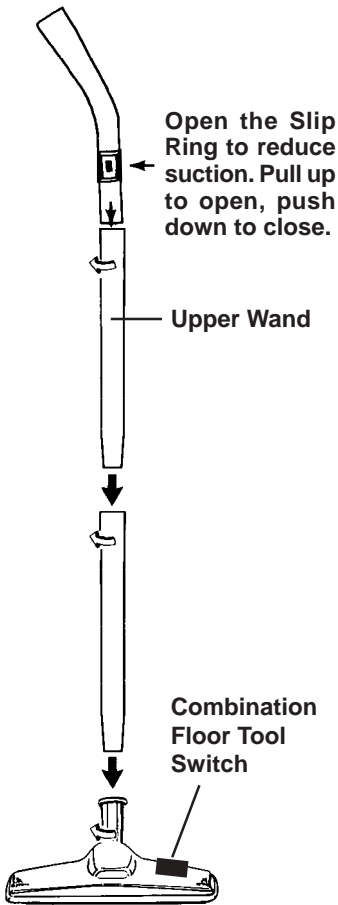

**Combination Floor Tool:** For bare floor cleaning push firmly on the back of the switch to engage floor bristles. For cleaning carpet push firmly on the front of the switch to retract floor bristles.

Slip the circular end of an accessory tool onto the end of the hose handle and twist slightly to secure. If additional reach is needed, place a wand on the hose handle first.

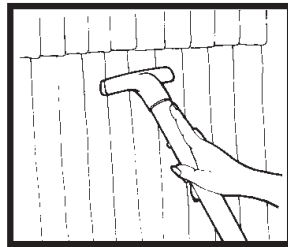

**Upholstery Nozzle:** For curtains, draperies, cushions, fabrics.

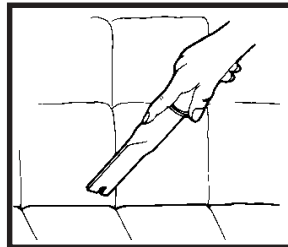

**Crevice Tool:** For crevices, corners, baseboards, between cushions.

## HOW TO MAINTAIN

The instructions given in this booklet serve as a guide to routine maintenance. To avoid unnecessary service calls, check the hose, bag and filter often. Change the bag if it is full, and clean the motor filter when it is dirty.

**NOTE: Turn off the switch and unplug the electrical cord before servicing the vacuum.**

### Disposable Dust Bags and Filters

The dust bag and motor filter play a very important roll in the efficiency of the vacuum cleaner. The purpose of the dust bag is to trap dirt, but at the same time, the paper bag must be porous enough to allow air to pass through. If the bag or the motor filter become clogged, no air can pass through the cleaner and no cleaning can take place regardless of how powerful the unit is. To keep the cleaner operating at maximum efficiency, change the dust bag frequently and clean the filter as needed. Some fine particles can restrict airflow very quickly and will decrease performance even before the bag appears to be full. For that reason, when vacuuming carpet fresheners or cleaners, powder, plaster dust, or similar fine substances, the bag and filter may need to be changed more often.

### How to Remove Disposable Dust Bags—Style UB

**NOTE: Turn off vacuum and unplug the electrical cord before changing dust bag or cleaning motor filter. Never operate the vacuum cleaner without the dust bag or filter.**

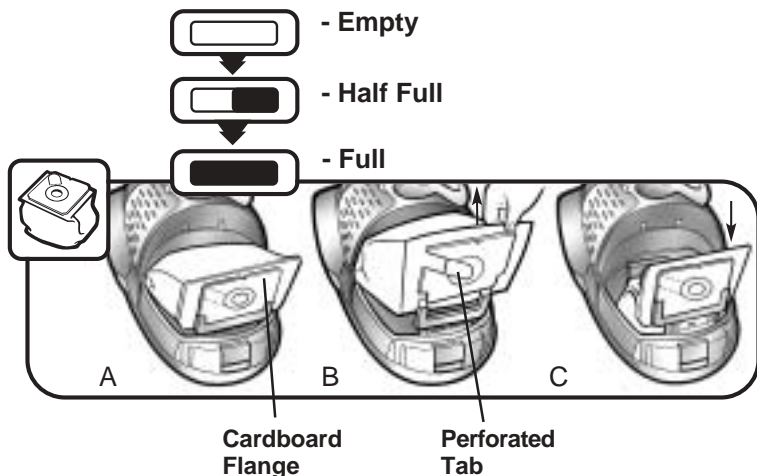

- Pull up on the cardboard flange to remove full dust bag.
- Bend perforated tab and cover bag opening; discard.
- With hole of new bag facing forward, insert cardboard flange into guides with the embossed arrow on the cardboard facing down.  
Replace bag cover by placing hook in center slot and pressing down to secure.

**NOTE: Make sure bag is tucked inside of the back wall of the bag cover.**

**NOTE: Bag lid will not close unless bag is in place.**

Use GENUINE EUREKA replacement bag, 61240.



# Changing/Cleaning the Filters

The filters play a very important role in the efficiency of the vacuum cleaner. If the filters become clogged, no air can pass through the cleaner and no cleaning takes place regardless of how powerful the unit. To keep the cleaner operating at maximum efficiency, check the filters frequently and clean when necessary.

There are two filters in your vacuum. The cleaner must never be used without the filters.

## Motor Filter



- D. Release catch for dust bag compartment. Remove lid and dust bag. Remove motor filter.
- E. Wash filter in warm water.
- F. **NOTE: Allow to dry completely and re-insert clean filter.**

Use **GENUINE EUREKA** motor filter, 72696.

## Micron Filter

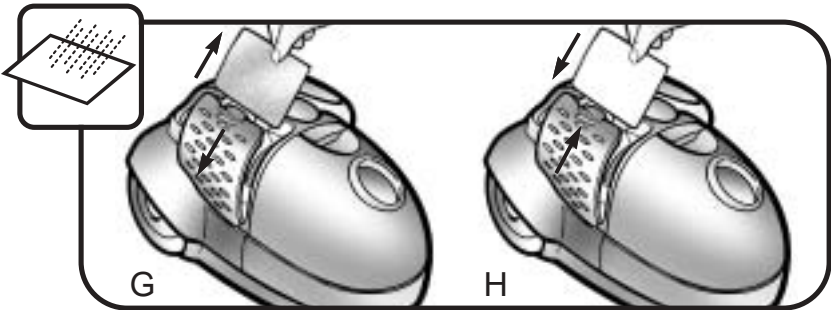

- G. Release catch for filter compartment cover. Open the filter cover and remove filter.
- H. Insert new filter and close cover.

**NOTE: This filter is not washable and should be replaced on a regular basis to maintain optimum performance.**

Use **GENUINE EUREKA** micron filter, 72724.

## PROBLEM SOLVING

**NOTE: Turn OFF the power switch and unplug the electrical cord before servicing.**

PROBLEM	CAUSE	SOLUTION
Motor won't start	<input checked="" type="checkbox"/> Electric plug  <input checked="" type="checkbox"/> Power switch not turned "ON"	<input type="checkbox"/> Push plug securely into outlet. <input type="checkbox"/> Try another outlet. <input type="checkbox"/> Check circuit breaker. <input type="checkbox"/> Make sure power switch is "ON."
No suction at end of hose	<input checked="" type="checkbox"/> Full paper bag <input checked="" type="checkbox"/> Hose  <input checked="" type="checkbox"/> Front cover not latched	<input type="checkbox"/> Replace paper bag. <input type="checkbox"/> Remove any clogs from hose that restrict airflow, then try again. <input type="checkbox"/> Push front cover until it latches firmly.
Reduced suction	<input checked="" type="checkbox"/> Full paper bag <input checked="" type="checkbox"/> Slip ring open  <input checked="" type="checkbox"/> Hose  <input checked="" type="checkbox"/> Rotate On/Off Button	<input type="checkbox"/> Replace paper bag. <input type="checkbox"/> Rotate slip ring on wand until hole is covered. <input type="checkbox"/> Remove any clogs from hose that restrict airflow, then try again. <input type="checkbox"/> Rotate to increase suction.
Cleaner shuts off	<input checked="" type="checkbox"/> Thermal Cut-Off	<input type="checkbox"/> See instructions on page 4.
General questions	<input checked="" type="checkbox"/> Assembly or related questions.	<input type="checkbox"/> Call 1-800-282-2886 between 8:00 AM–7:30 PM (CST) Monday-Friday, 10:00AM to 6:30PM Saturday. Know the Model number and serial number when you call.

# ***THE SANITAIRE LIMITED WARRANTY***

## ***What This Warranty Covers***

Your Sanitaire cleaner is warranted to be free from all defects in material and workmanship in normal household use for a period of one year. The warranty is granted only to the original purchaser and members of his or her immediate household. The warranty is subject to the following provisions.

## ***What This Warranty Does Not Cover***

- Parts of the cleaner that require replacement under normal use, such as disposable dust bags, filters, drive belts, light bulbs, and brush roll bristles.
- Damages or malfunctions caused by negligence, abuse, or use not in accordance with the Owner's Guide.
- Defects or damages caused by unauthorized service or the use of other than Genuine Eureka parts.

## ***What The Eureka Company Will Do***

The Eureka Company will, at its option, repair or replace a defective cleaner or cleaner part that is covered by this warranty. As a matter of warranty policy, the Eureka Company will not refund the consumer's purchase price.

## ***Extended Warranty for Upright Cleaner (Only)***

The base of the Sanitaire Upright cleaner is warranted for five years from the original date of purchase.

## ***Warranty Registration***

Please fill out and return the warranty registration card accompanying your cleaner.

## ***Obtaining Warranty Service***

To obtain warranty service you must return the defective cleaner or cleaner part along with proof of purchase to any Eureka/Sanitaire Authorized Warranty Station. You will find the nearest location in the Yellow Pages, under "Vacuum Cleaners—Service and Repair." Be certain that the Warranty Station is "Eureka/Sanitaire Authorized." For the location of the nearest Eureka/Sanitaire Authorized Warranty Station or for service information, telephone toll free:

**USA: 1-800-282-2886**

**Mexico: 5670-6169**

**Canada: 1-800-282-2886**

If you prefer, you can write to The Eureka Company, Service Division, 807 North Main Street, Bloomington, Illinois 61701. In Canada write to The Eureka Company, 866 Langs Drive, Cambridge, Ontario N3H 2N7.

If it is necessary to ship the cleaner outside your community to obtain warranty repair, you must pay the shipping charges to the Eureka/Sanitaire Authorized Warranty Station. Return shipping charges will be paid by the Warranty Station. When returning parts for repair, please include the model, type, and serial numbers from the data plate on the cleaner.

## Further Limitations and Exclusions

Any warranty that may be implied in connection with your purchase or use of the cleaner, including any warranty of Merchantability or any warranty for Fitness For A Particular Purpose is limited to the duration of this warranty. Some states do not allow limitations on how long an implied warranty lasts, so the above limitations may not apply to you.

Your relief for the breach of this warranty is limited to the relief expressly provided above. In no event shall Eureka be liable for any consequential or incidental damages you may incur in connection with your purchase or use of the cleaner. Some states do not allow the exclusion or limitation of incidental or consequential damages, so the above limitation or exclusion may not apply to you.

This warranty gives you specific legal rights. You may also have other rights which vary by state.



## Questions & Answers about Genuine Eureka Products

**Q:** Why should I use only Genuine Eureka paper bags, belts, and parts in my Eureka vacuum cleaner?

**A:** Using Genuine Eureka Products, which are made to our exacting specifications and engineered with emphasis on quality, performance, and customer satisfaction, ensures the long life and cleaning efficiency of your vacuum cleaner. Overall, this saves you money and helps to keep your home clean.

**Q:** Are there any differences between "made to fit" or "imitation" and Genuine Eureka paper bags, belts, and parts?

**A:** Typically, packaged products and paper bags can be identified by a "Genuine Eureka Product" symbol (see illustration above). For further identification assistance, you may call our toll-free number, 1-800-282-2886, for the location of a nearby Eureka/Sanitaire Authorized Warranty Station.

**Q:** Are there any differences between "made to fit" or "imitation" and Genuine Eureka paper bags, belts, and parts?

**A:** Yes, there are some very important differences in materials, quality, and reliability. Many customers have mistakenly purchased "imitation" paper bags and parts while thinking they purchased genuine. Unfortunately, many of these customers discovered the differences after they experienced related difficulties.

**For Genuine Eureka Value, Accept No Limitations!**



THE EUREKA COMPANY

Bloomington, Illinois 61701

Household Warranty

©1999 White Consolidated, . Ltd.

Printed in China.