

Satellite A105-S4011 Detailed Product Specification¹

Model Name	Description	Part Number	UPC
A105-S4011	Microsoft® Windows® XP Home, Intel® Core™ Solo Processor T1300, 512MB DDR2, 80GB 5400rpm (S-ATA), DVD SuperMulti (+/- R double layer), 15.4" TruBrite™ widescreen WXGA, Intel® Graphics Media Accelerator 950, Intel® PRO/Wireless 3945ABG (802.11a/b/g), 1-year standard limited warranty	PSAA8U-05400J	032017542396

Operating System²

- Microsoft® Windows® XP Home
- TOSHIBA Express Media Player³
 - Quick access for CD and DVD watching

Processor and Chipset⁴

Intel® Centrino™ Mobile Technology featuring:

- Intel® Core™ Solo Processor T1300
 - 1.66GHz, 2MB L2, 667MHz FSB
- Mobile Intel 945GM Express Chipset
- Intel PRO/Wireless 3945ABG (802.11a/b/g)

Memory⁵

- Configured with 512MB DDR2 SDRAM (both memory slots may be occupied)
- 512MB(min)/4096MB (max), 2 memory slots using 256MB, 512MB, 1024MB or 2048MB PC4200 DDR2 533MHz SDRAM, dual-channel support requires two memory modules of same capacity and clockspeed

Hard Disk Drive⁶

- 80GB (5400RPM); Serial-ATA (SATA) hard disk drive; 9.5mm height; user removable

Fixed Optical Disk Drive⁷

- DVD SuperMulti (+/-R double layer) drive supporting 11 formats
 - Maximum speed and compatibility: CD-ROM (24x:read), CD-R (24x:write), CD-RW (16x:write), DVD-ROM (8x:read), DVD-R (Single Layer, 8x:write), DVD-R (Double Layer, 4x: write), DVD-RW (6x:write), DVD+R (Single Layer, 8x:write), DVD+R (Double Layer, 4x:write), DVD+RW (8x:write), DVD-RAM (5x:write)

Display⁸

- 15.4" diagonal widescreen TruBrite™ TFT active-matrix LCD display at 1280x800 native resolution (WXGA)

Graphics⁹

- Intel Graphics Media Accelerator 950 with 8MB-128MB dynamically allocated shared graphics memory

Sound

- Built-in stereo speakers
- Realtek ALC861 16-bit stereo software sound
 - Supports 3D Sound, Direct 3D Sound, DirectSound, Direct Music, MIDI (playback), Intel High Definition Audio
- Sound Volume Control Dial
- SRS Labs audio enhancements¹⁰
 - SRS TruSurround XT® virtual surround sound
 - SRS WOW™ stereo enhancement

Input Devices

- Keyboard

- 85 key US keyboard
- Hot Key Functions (Fn)
- Windows Key Function
- Application Key Function
- TouchPad™ Enable/Disable (FN+F9 or by help of software)
- TouchPad™ pointing device
- Control Buttons:
 - Internet button to launch default browser
 - Express Media Player CD/DVD launch button
 - CD/DVD control buttons (Skip to Previous/Next Track, Play, Stop)

Communications

- Toshiba V.92 software modem¹¹
- Intel PRO/100 VE Network Connection - 10/100 Base-TX Ethernet
- Integrated Intel Pro/Wireless Network Connection 3945ABG (802.11a/b/g)¹²

Expandability

- 2 main memory slots. Both slots may be occupied.
- 1 PC Card slot support 1 Type II, PCMCIA R2.01, PC Card16, CardBus
- ExpressCard slot supporting ExpressCard/34 and ExpressCard/54
- 5-in-1 Bridge Media Adapter
 - Secure Digital, Memory Stick™, Memory Stick PRO™, Multi Media Card, xD Picture Card [shared slots]

Ports

- Video
 - RGB (monitor) output port
 - S-Video output port
- Audio
 - Headphone output port
 - Microphone input port
- Data
 - i.LINK(tm) IEEE-1394
 - Universal Serial Bus (USB v2.0) – 4 ports
 - RJ-45 LAN port
 - RJ-11 modem port

Physical Description for this Product Series

- Dimensions (WxDxH Front/H Rear): 14.2" (360.0mm) x 10.5" (267mm) x 1.17" (29.8mm)[F]/1.45" (36.8mm)[R] without feet
- Weight: Starting at 6.0 lbs (2.72 kg) depending upon configuration¹³
- Indicators: DC-IN, HDD, CD/DVD-ROM, CapsLock, Arrow Mode, Numeric Mode, Battery, System Sleep, Wireless
- Chassis Description
 - Case material: PC-ABS Plastic
 - LCD Cover Color: Mist Gray
- Physical Security
 - Slot for cable lock; Yes
 - Items protected by a screw: Memory, HDD, LAN
- Software Security
 - Passwords: User power-on password, supervisor password
 - Hotkey locks: Screen Blank

TOSHIBA

Power Supply

- 75W (15V x 5A) Auto sensing external AC Adapter, 100-240V / 50-60Hz frequency (Universal) input.
- Dimensions (WxDxH): 5.0" (128mm) x 2.0" (51mm) x 1.2" (31mm)
- Weight: starting at 0.82 lbs (370 g)

Battery¹⁴

- 6-cell (4000mAh) rechargeable, removable Lithium Ion (Li-Ion) battery pack
- Dimensions (WxDxH): 8.1" (207mm) x 0.91" (23mm) x 2.1" (54mm)
- Weight: starting at 0.75 lbs (340g)
- Battery Life (measured by MobileMark™)¹⁵
 - Included 6-cell battery: 3 hours, 27 minutes
- Recharge Time
 - Main Battery Off/On – up to 4.0 hrs/up to 12.0 hrs

BIOS

- TSETUP, APM v.1.2, ACPI v1.0b, PNP v1.0, VESA, DPMS, DDC, SM BIOS v2.3, PCI BIOS v2.1 support

Software¹⁶

- Toshiba Software and Utilities
 - TOSHIBA ConfigFree®
 - TOSHIBA Custom Utilities
 - Electronic User's Guide
- Third-party Software
 - Microsoft Office® OneNote® 2003
 - Microsoft Works® Version 8.5
 - Sun® Java™ 2 Runtime Environment
 - Adobe® Acrobat® Reader
 - InterVideo® WinDVD® 5
 - InterVideo® WinDVD Creator 2 Platinum
 - Sonic Solutions® RecordNow!™ Basic for Toshiba
 - Sonic Solutions® Drive Letter Access™ (DLA)
 - Microsoft® Windows Media Player version 10
 - Yahoo! Music Engine
- Trial Software
 - McAfee® VirusScan® (30-day trial)
 - Microsoft Office® (60 Day Student Teacher Edition)
 - AOL® Internet Service (90-day trial)¹⁷

Environmental Specifications

	Operating	Non-operating
Temperature ¹⁸	5° to 35° C (41° to 95° F)	-20° to 65° C (-4° to 149° F)
Thermal Gradient	15° C per hour (max)	20° C per hour (max)
Relative Humidity (non-condensing)	20% to 80%	10% to 95%
Altitude (relative to sea level)	-60 to 3,000 meters	-60 to 10,000 meters
Shock	10G	60G
Vibration	0.5G	1.0G

SATELLITE – 1 YEAR STANDARD LIMITED WARRANTY¹⁹

Service Upgrades and Extensions

Toshiba offers many different enhanced services such as SystemGuard®, At-Home Repair, and Service Express to provide additional support to your notebook PC. For a full description and complete list of programs and program extensions, please visit www.pcsupport.toshiba.com

Recommended Services

Extended Service Plan

Extends the standard limited warranty for up to 3 years from the original notebook purchase date.

Part Number	Description
WSN-PEQQ2V	2nd Year Extended Service Plan

WSN-PEQQ3V 2nd/3rd Year Extended Service Plan

SystemGuard Accidental Damage Service w/ ServiceExpress²⁰

Provides advanced protection from damage caused from handling. Select your express repair service with either Depot Express or Carry-In Express and go to the front of the line. Extended Service Plan included except with 1 Year plan. SystemGuard coverage must be purchased within the first 30 days of notebook purchase.

Part Number	Description
WSN-PSGQ1V	1st Year
WSN-PEGQ2V	1st/2nd Year + Extended Service Plan
WSN-PEGQ3V	1st/2nd/3rd Year + Extended Service Plan

SystemGuard Accidental Damage Service + At-Home Repair²¹

Combines SystemGuard and At-Home Repair coverage. Extended Service Plan included except with 1 Year plan. SystemGuard coverage must be purchased within the first 30 days of purchase.

Part Number	Description
WSN-PSGH1V	1st Year
WSN-PEGH2V	1st/2nd Year + Extended Service Plan
WSN-PEGH3V	1st/2nd/3rd Year + Extended Service Plan

ServiceExpress

Select your express repair service with either Depot Express or Carry-In Express. Depot Express: Your notebook will be repaired and returned via overnight shipment (excluding weekends and holidays). Carry-In Express: Take your notebook into a Premier ASP and go to the front of the line for expedited repair service. Extended Service Plan included except with 1 Year plan.

Part Number	Description
WSN-PSQP1V	1st Year
WSN-PEQP2V	1st/2nd Year + Extended Service Plan
WSN-PEQP3V	1st/2nd/3rd Year + Extended Service Plan

At-Home Repair

On-site service will be provided at customer's home location (excluding weekends and holidays) to perform the necessary hardware repairs. Extended Service Plan included except with 1 Year plan.

Part Number	Description
WSN-PSQH1V	1st Year
WSN-PEQH2V	1st/2nd Year + Extended Service Plan
WSN-PEQH3V	1st/2nd/3rd Year + Extended Service Plan

Accessories

For memory compatibility and the most updated accessories, please visit www.accessories.toshiba.com

Memory

Part Number	Description
PA3412U-2M51	Toshiba 512MB DDR2-533 Memory Kit, RoHS
PA3411U-2M1G	Toshiba 1GB DDR2-533 Memory Kit, RoHS

Power

Part Number	Description
PA3468U-1ACA	Toshiba 75W Global AC Adapter (19v) RoHS Compliant
PA3457U-1BRS	Toshiba Primary High Cap Li Ion Battery Pack (8 Cell) 14.4v x 4300mAh

Security & Protection

Part Number	Description
PA1370U-1ETC	Toshiba Keyboard Protector
PA410U	Targus DEFCON CL Cable Lock

Storage

Part Number	Description
PA3109U-3FDD	Toshiba USB Floppy Disk Drive Kit, RoHS
PA1399U-1MEM	Toshiba 1GB USB Hi-Speed Flash Drive

Wireless/Bluetooth

Part Number	Description
PA3455U-1BTM	Toshiba USB Adapter with Bluetooth 2.0+EDR capability

Subject to Change

While Toshiba has made every effort at the time of publication to ensure the accuracy of the information provided herein, product specifications, configurations, prices, system/component/options availability are all subject to change without notice. For the most up-to-date product information about your computer, or to stay current with the various computer software or hardware options, visit Toshiba's Web site at <http://www.pcsupport.toshiba.com>

Return Policy

Notwithstanding anything to the contrary in any third party License Agreement or product documentation supplied with your PC, Toshiba America Information Systems, Inc. ("TAIS") does not accept the return of component parts, or bundled software, that have been removed from the PC system. Pro-rata refunds on individual PC components or bundled software, including the operating system, will not be granted. If you wish to return a complete PC system, contact the TAIS dealer where you purchased the product, and comply with the dealer's standard return policies and procedures.

Toshiba America Information Systems, Incorporated ("TAIS")
9740 Irvine Boulevard
Irvine CA 92618
ToshibaDirect website: <http://www.toshibadirect.com>
TAIS website for resellers: <http://sell.toshiba.com>
TAIS PC Support website: <http://pcsupport.toshiba.com>

Portégé, Satellite, Tecra, SelectBay, ConfigFree and SystemGuard are registered trademarks and Qosmio and EasyGuard are trademarks of Toshiba America Information Systems, Inc. and/or Toshiba Corporation. Intel, Celeron, Centrino, Intel Inside, Pentium, the Intel Centrino logo, and the Intel Inside logo are trademarks or registered trademarks of Intel Corporation or its subsidiaries in the United States and other countries. Microsoft and Windows are registered trademarks and OneNote registered is a trademark of Microsoft Corporation in the United States and/or other countries. Winstone® is a registered trademark and BatteryMark™ is a trademark of Ziff Davis Publishing Holdings Inc. in the U.S. and other countries. MobileMark™ is a trademark of the Business Applications Performance Corporation. Wi-Fi is a registered certification mark of the Wi-Fi Alliance. The Bluetooth word mark and logos are owned by the Bluetooth SIG, Inc. and any use of such marks by Toshiba is under license. NVIDIA and GeForce are registered trademarks or trademarks of NVIDIA Corporation in the United States and/or other countries. All other trademarks are the property of their respective owners.

¹ **Product Series Legal Footnote.** The product specifications and configuration information are designed for a product Series. Your particular model may not have all the features and specifications listed or illustrated. For more detailed information about the features and specifications on your particular model, please visit Toshiba's Web site at pcsupport.toshiba.com.

Product Offering Legal Footnote. Toshiba America Information Systems, Inc. reserves the right to modify or withdraw this offer at anytime without notice.

² **Operating System.** Certain Microsoft® software product(s) included with this computer may use technological measures for copy protection. IN SUCH EVENT, YOU WILL NOT BE ABLE TO USE THE PRODUCT IF YOU DO NOT FULLY COMPLY WITH THE PRODUCT ACTIVATION PROCEDURES. Product activation procedures and Microsoft's privacy policy will be detailed during initial launch of the product, or upon certain reinstallations of the software product(s) or reconfigurations of the computer, and may be completed by Internet or telephone (toll charges may apply).

Some software may differ from its retail version (if available), and may not include user manuals or all program functionality.

Offers. Offer terms, duration and product availability all subject to change without notice

³ **Toshiba Express Media Player.** The Toshiba Express Media Player is not a Windows-based application.

⁴ **Processor (Central Processing Unit).**

CPU performance in your computer product may vary from specifications under the following conditions:

1. use of certain external peripheral products
2. use of battery power instead of AC power
3. use of certain multimedia, computer generated graphics or video applications
4. use of standard telephone lines or low speed network connections
5. use of complex modeling software, such as high end computer aided design applications
6. use of several applications or functionalities simultaneously
7. use of computer in areas with low air pressure (high altitude >1,000 meters or >3,280 feet above sea level)
8. use of computer at temperatures outside the range of 5°C to 30°C (41°F to 86° F) or >25°C (77°F) at high altitude (all temperature references are approximate and may vary depending on the specific computer model – please visit the Toshiba website at www.pcsupport.toshiba.com for details).

CPU performance may also vary from specifications due to design configuration.

Under some conditions, your computer product may automatically shut-down. This is a normal protective feature designed to reduce the risk of lost data or damage to the product when used outside recommended conditions. To avoid risk of lost data, always make back-up copies of data by periodically storing it on an external storage medium. Use your computer product only under recommended conditions. Read additional restrictions under "Environmental Conditions" in your product "Detailed Specs." Contact Toshiba Technical Service and Support for more information.

⁵ **Memory (Main System).** Part of the main system memory may be used by the graphics system for graphics performance and therefore reduce the amount of main system memory available for other computing activities. The amount of main system memory allocated to support graphics may vary depending on the graphics system, applications utilized, system memory size and other factors. For PC's configured with 4 GB of system memory, the full system memory space for computing activities will be considerably less and will vary by model and system configuration.

⁶ **Hard Disk Drive (HDD) Capacity.**

1 Gigabyte (GB) means $10^9 = 1,000,000,000$ bytes using powers of 10. The computer operating system, however, reports storage capacity using powers of 2 for the definition of 1 GB = $2^{30} = 1,073,741,824$ bytes, and therefore shows less storage capacity. Available storage capacity will also be less if the product includes one or more pre-installed operating systems, such as Microsoft Operating System and/or pre-installed software applications, or media content. Actual formatted capacity may vary.

⁷ **Optical Drive.** Due to manufacturing and quality variations in third party optical media (e.g., CD or DVD) or optical media players/recorders, in certain cases, your Toshiba optical drive may not record on certain optical media that bear the applicable logo, or playback optical media recorded by other PCs or optical media recorders. Additionally, certain optical media recorded on your optical drive may not playback or operate properly on other PCs or optical media players. These problems are not due to any defect in your Toshiba PC or optical drive. Please refer to your PC's product specification for listing of specific format compatibilities.

Copy protection technology may also prevent or limit recording or viewing of certain optical media.

⁸ **Display.** Small bright dots may appear on your screen display when you turn on your PC. Your display contains an extremely large number of thin-film transistors (TFT) and is manufactured using high-precision technology. Any small bright dots that may appear on your display are an intrinsic characteristic of the TFT manufacturing technology. Over a period of time, and depending on the usage of the computer, the brightness of the screen will deteriorate. This is also an intrinsic characteristic of the screen technology.

When the computer is operated on battery power, the screen will dim and you may not be able to increase the brightness of the screen while on battery power.

⁹ **Graphics (Graphics Processing Unit).**

GPU performance may vary depending on product model, design configuration, applications, power management settings and features utilized. GPU performance is only optimized when operating in AC power mode and may decrease considerably when operating in battery power mode.

¹⁰ **SRS Audio Enhancements:**

SRS TruSurround XT is available in the Microsoft® Windows® operating system only

¹¹ **Modem Speed.** Due to FCC limitations, speeds of 53 kbps are the maximum permissible transmission rates during download. Actual data transmission speeds will vary depending on line conditions.

¹² **Wireless.** Wireless connectivity and some features may require you to purchase additional software, external hardware or services. Availability of public wireless LAN access points may be limited. The transmission speed over the wireless LAN and the distance over which wireless LAN can reach may vary depending on surrounding electromagnetic environment, obstacles, access point design and configuration, and client design and software/hardware configurations. The actual transmission speed will be lower than the theoretical maximum speed. To use the Atheros SuperAG™ or SuperG™ wireless function, if available, your client and access point must support the corresponding feature. Performance of these functions may vary depending on the format of data transmitted.

¹³ **Weight.** Weight may vary depending on product configuration, vendor components, manufacturing variability and options selected.

¹⁴ **Battery Life.** Battery life may vary considerably from specifications depending on product model, configuration, applications, power management settings and features utilized, as well as the natural performance variations produced by the design of individual components. Published battery life numbers are achieved on select models and configurations tested by Toshiba at the time of publication. See "Detailed Specs" for specific battery measurement test.

Recharge time varies depending on usage. Battery may not charge while computer is consuming full power. After a period of time, the battery will lose its ability to perform at maximum capacity and will need to be replaced. This is normal for all batteries. To purchase a new battery pack, see the accessories information that shipped with your computer or visit the Toshiba web site at www.accessories.toshiba.com.

¹⁵ **Battery Life - MobileMark™.** Measured by MobileMark. MobileMark is a trademark of the Business Applications Performance Corporation.

¹⁶ **Software.** Some software may differ from its retail version (if available), and may not include user manuals or all program functionality.

Certain Microsoft® software product(s) included with this computer may use technological measures for copy protection. IN SUCH EVENT, YOU WILL NOT BE ABLE TO USE THE PRODUCT IF YOU DO NOT FULLY COMPLY WITH THE PRODUCT ACTIVATION PROCEDURES. Product activation procedures and Microsoft's privacy policy will be detailed during initial launch of the product, or upon certain reinstallations of the software product(s) or reconfigurations of the computer, and may be completed by Internet or telephone (toll charges may apply).

¹⁷ **AOL® Internet Service.** Availability may be limited, especially during peak times. TO AVOID BEING CHARGED A MONTHLY MEMBERSHIP FEE, SIMPLY CANCEL BEFORE THE THREE-MONTH PROMOTIONAL PERIOD ENDS. Premium services carry surcharges and communication surcharges may apply, including AK, even during promotional period. Members may incur telephone charges on their phone bill, depending on their location and calling plan, even during promotional period. Available to new AOL members in the United States, age 18 or older; a major credit card or checking account is required.

¹⁸ **Temperature (Environmental) Conditions.** All temperature references are approximate and the performance of your computer may vary from specifications even when operating within the recommended temperature range.

¹⁹ **Warranty:** Toshiba's standard limited warranty terms and conditions are available at www.warranty.toshiba.com.

²⁰ **SystemGuard:** SystemGuard coverage must be purchased within the first 30 days of notebook purchase. See Toshiba Service Plan Agreement for program terms and conditions at www.pcsupport.toshiba.com.

²¹ **SystemGuard:** SystemGuard coverage must be purchased within the first 30 days of notebook purchase. See Toshiba Service Plan Agreement for program terms and conditions at www.pcsupport.toshiba.com.

Front with display open

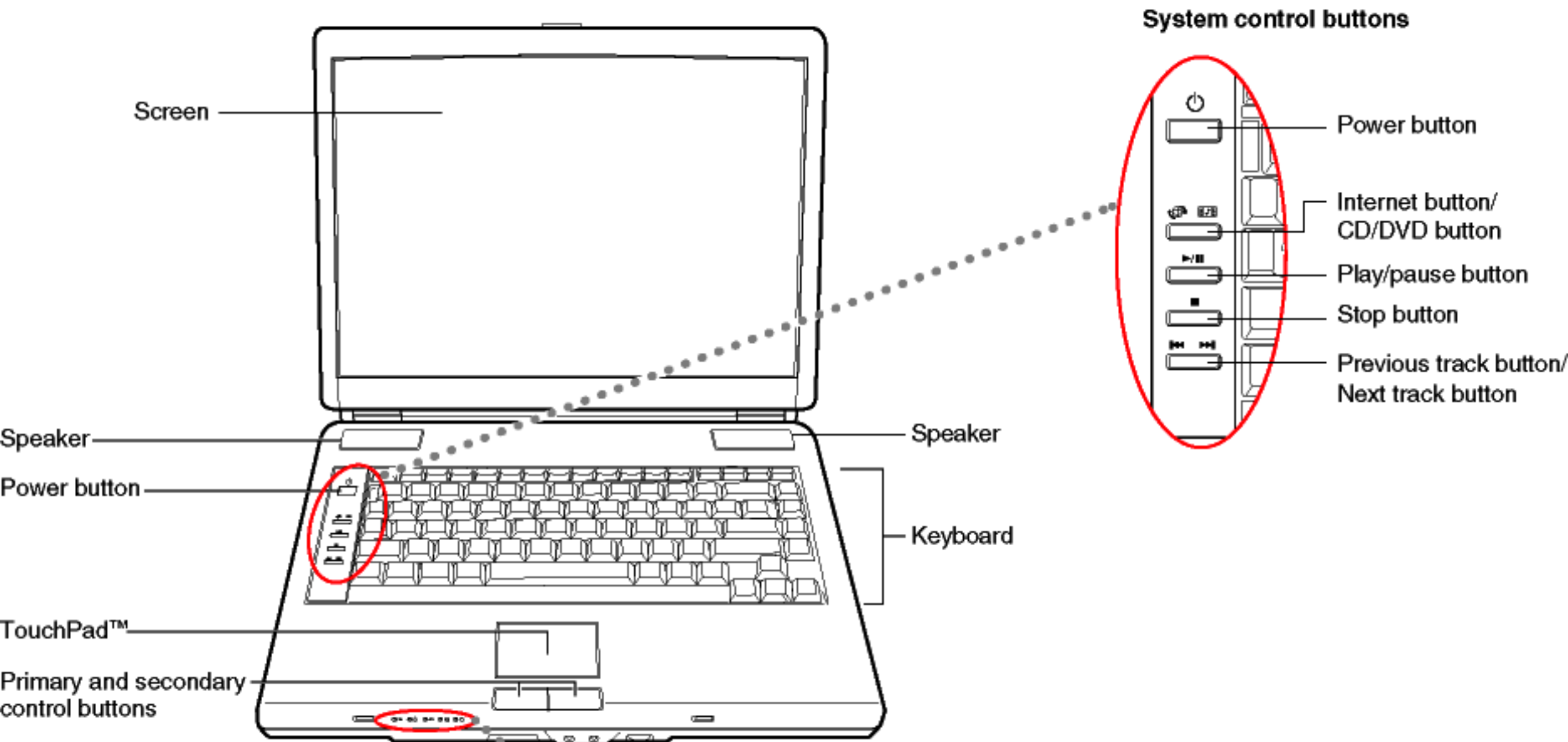

System control buttons

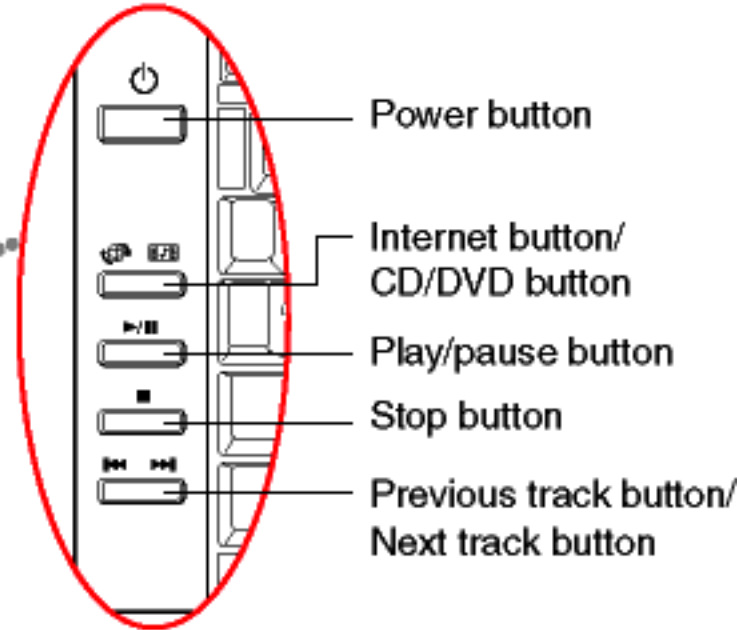

System indicator lights

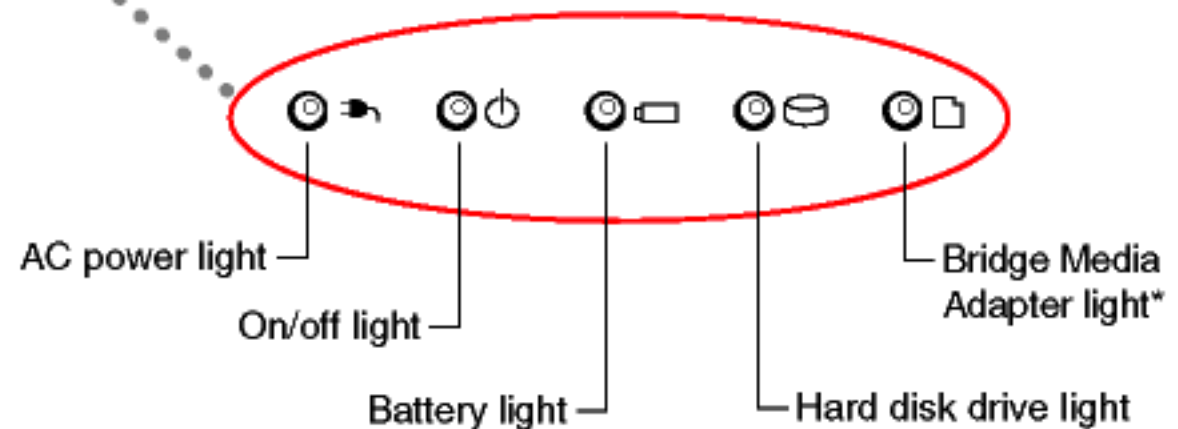

*Available on certain models.

Left side

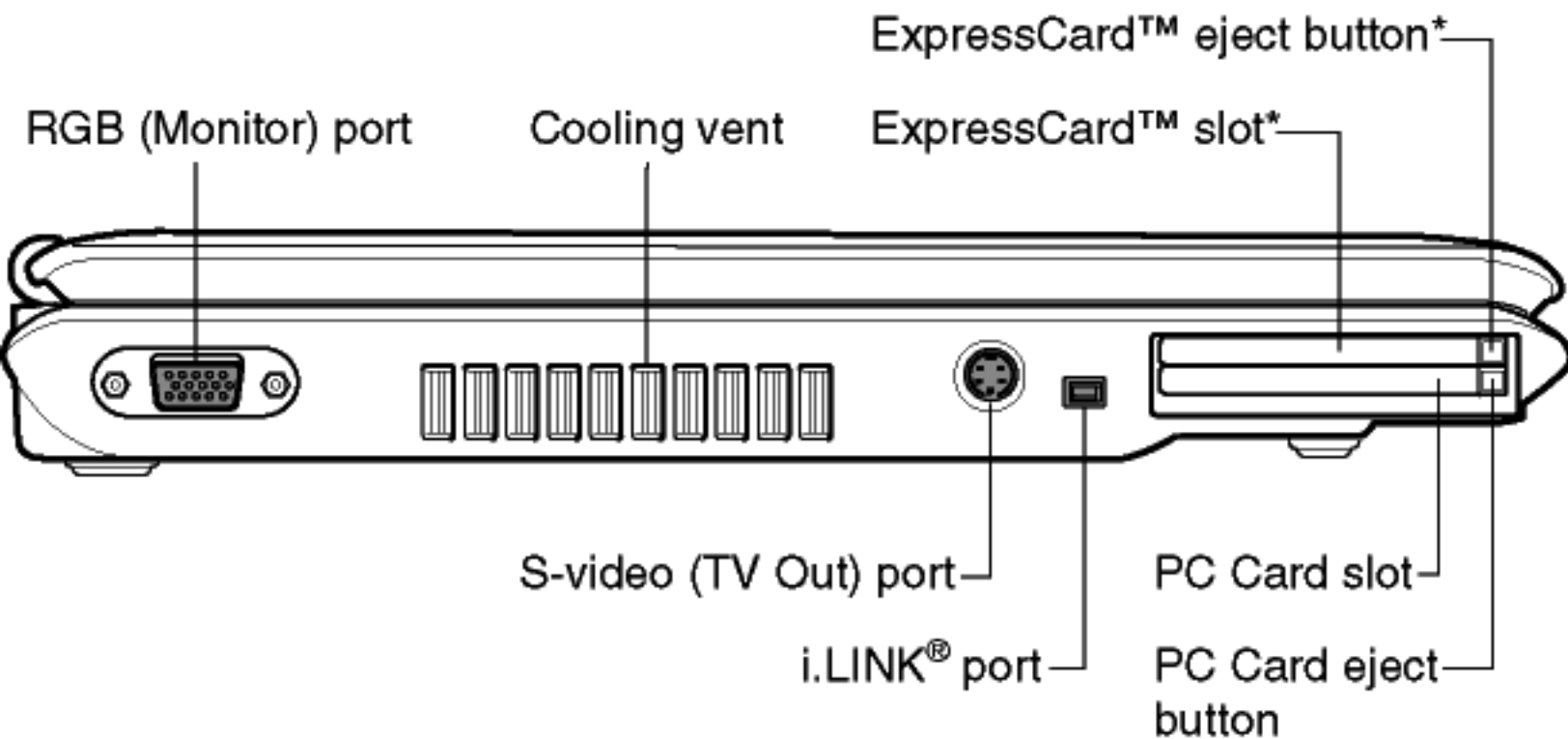

*Available on certain models.

Right side

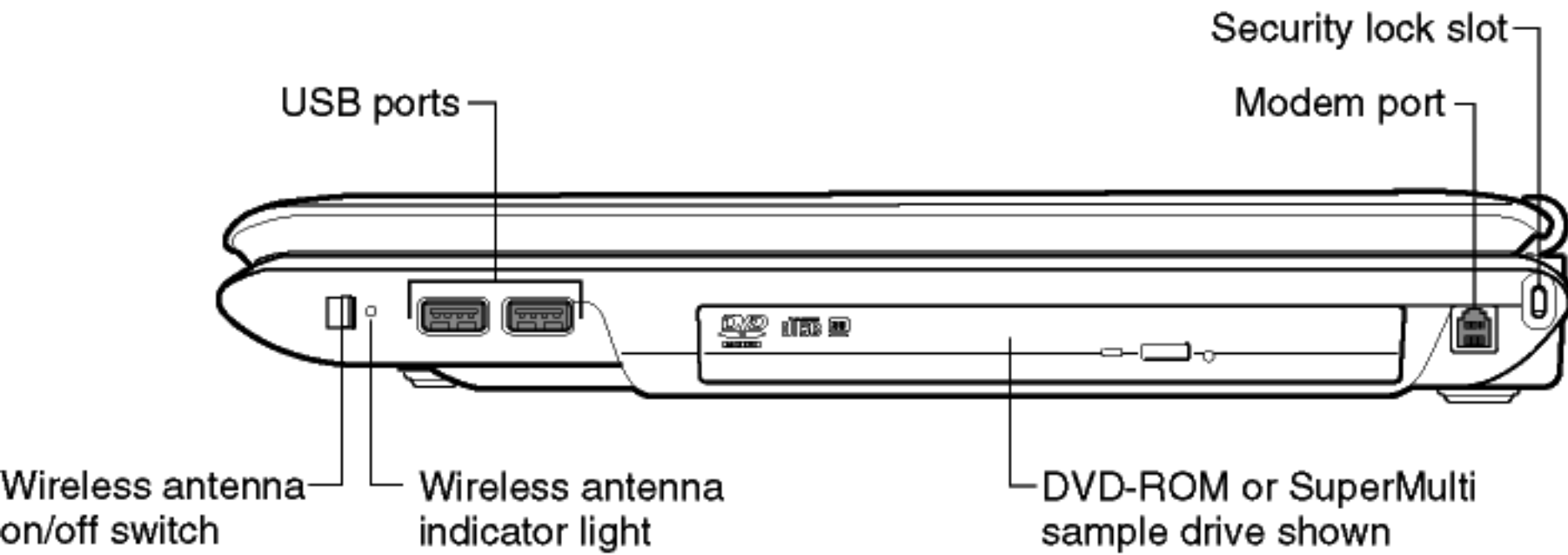

Underside

Battery module

Battery release lock

Battery release

Memory cover

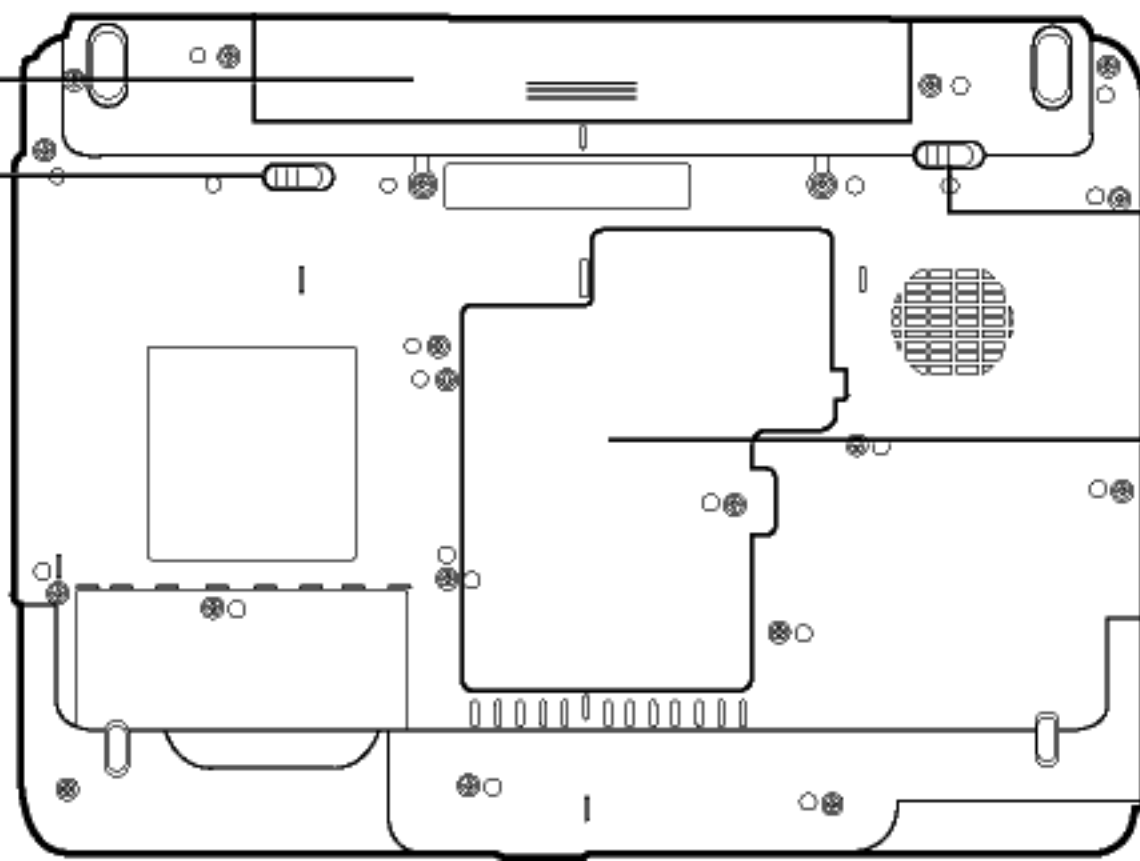

Back

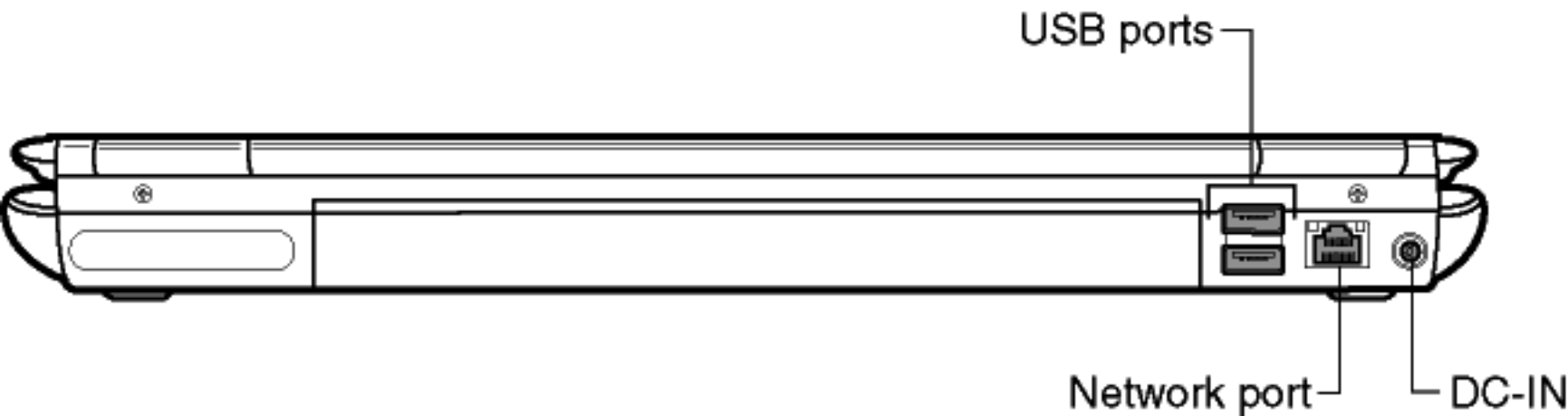

Front with display closed

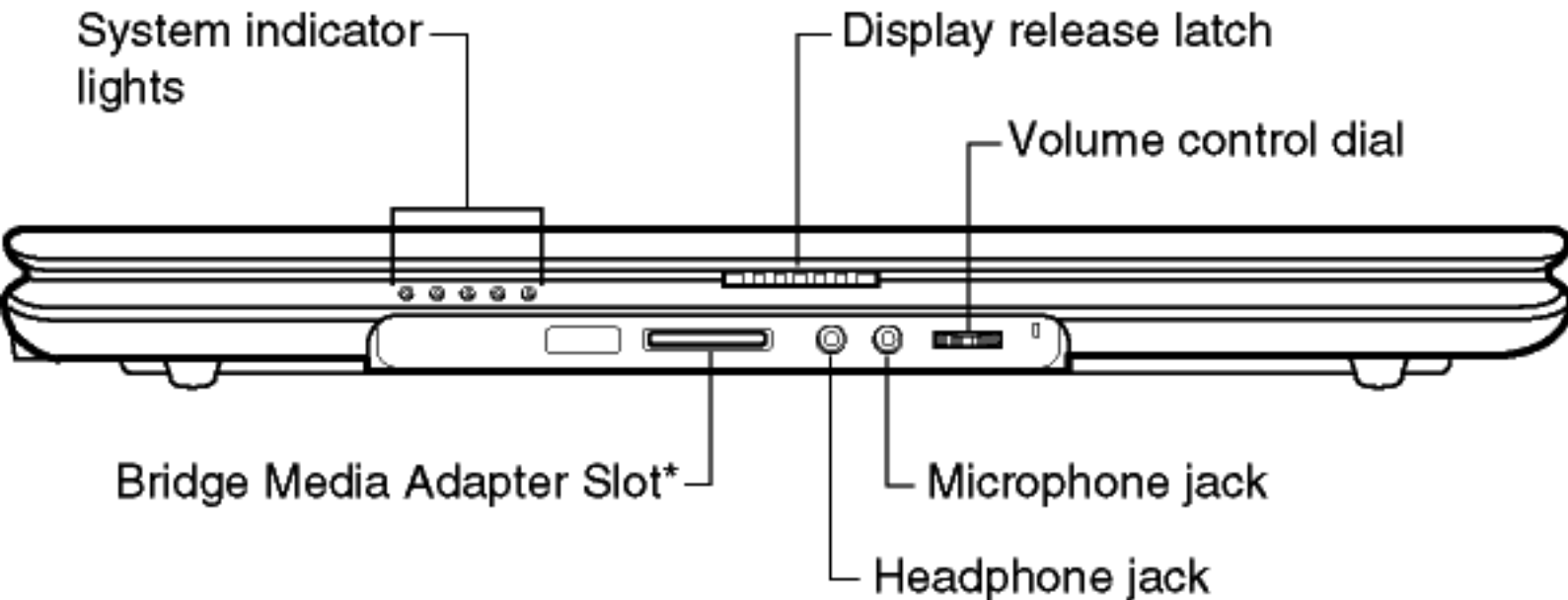

*Available on certain models.