

Thank you for purchasing a RadioShack Adjustable View Caller ID Box. Your Caller ID Box stores and displays up to 64 multiple (name and number) or 99 single (number-only) Caller ID records. It displays the caller's telephone number (and name, if available in your area) and the current date and time, as provided by your local phone company to Caller ID service subscribers.

Where Caller ID is offered, one or more of the following options are generally available: !

- caller's number only
- caller's name only
- caller's name and number

The actual number of Caller ID records your Caller ID box stores depends on the Caller ID information sent by the phone company. If your phone company sends name-and-number records, your Caller ID box stores up to 64 records. If your phone company sends number-only records, your Caller ID box stores up to 99 records.

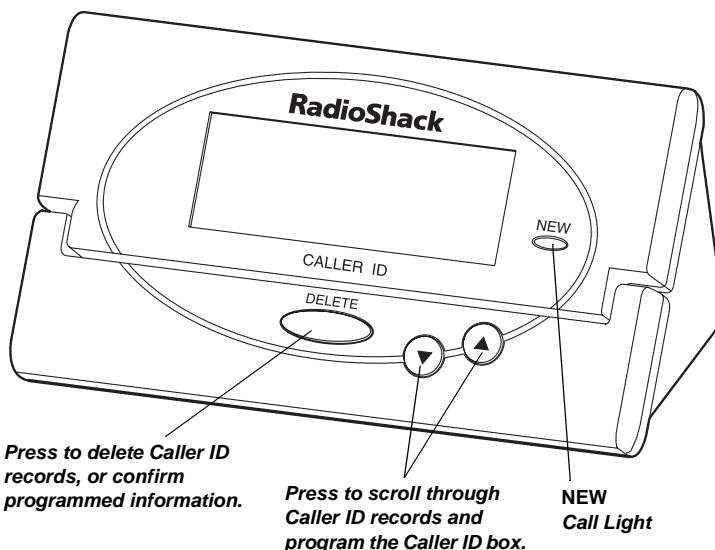

Press to delete Caller ID records, or confirm programmed information.

Press to scroll through Caller ID records and program the Caller ID box.

NEW Call Light

! IMPORTANT !

To use this Caller ID box, you must be in an area where Caller ID service is available, and you must subscribe to the service.

BATTERY NOTES

- Dispose of dead batteries promptly and properly.
- Do not burn or bury batteries.
- Use only fresh batteries of the required size and recommended type.
- Do not mix old and new batteries, different types of batteries (standard, alkaline, or rechargeable), or rechargeable batteries of different capacities.
- When you replace the batteries, do not press any buttons on the Caller ID box after you remove the old batteries. Doing so could erase all stored information.

CALLER ID BOX SETUP

Caller ID is a service provided by your telephone company. When you subscribe to this service, between the first and second rings, the telephone company sends the caller's telephone number (and name, if available) and the call's date and time. The Caller ID box receives and displays this information for each call and updates the display with the current date and time. Your Caller ID box saves up to 99 call records, then replaces the oldest call record with each new one.

INSTALLING BATTERIES

You need three AAA batteries (not supplied) to power and protect the Caller ID box's memory during a power failure. Batteries are available at your local RadioShack store or online at www.radioshack.com.

1. Use a flat-blade screwdriver to lift the compartment door on the bottom of the Caller ID box.
2. Place three fresh AAA batteries (not supplied) into the compartment as indicated by the polarity symbols (+ and -) marked inside.
3. Replace the battery cover and snap it closed.

When  appears or the display dims, replace the batteries.

CALLER ID BOX CONNECTION

Your Caller ID box is ETL listed to UL standards and meets all applicable FCC requirements.

Your Caller ID box connects directly to a modular telephone line jack. If your telephone wiring does not have a modular jack, you can update the wiring yourself using jacks and adapters (available at your local RadioShack store), or have the telephone company update the wiring for you. You must use compatible modular jacks that are compliant with Part 68 of *FCC Rules* and the requirements adopted by the ACTA. The telephone cord and modular plug provided is Part 68 compliant for connecting to the telephone company network.

The USOC number for both the single-line and two-line jacks to be installed is RJ11C (or RJ11W for a wall plate jack).

Connecting to a Single-Line Phone

1. Disconnect the telephone line cord from the modular phone jack on the wall and plug it into the PHONE JACK on the back of the Caller ID box.
2. Plug the Caller ID box's pre-wired telephone line cord into the modular phone jack on the wall.

! IMPORTANT !

If an icon appears at the end of a paragraph, go to the box on that page with the corresponding icon for pertinent information.

! — Important
 — Note

Connecting to an Answering Machine

Be sure to set your answering machine to answer after two or more rings, so the Caller ID box has time to record the call information.

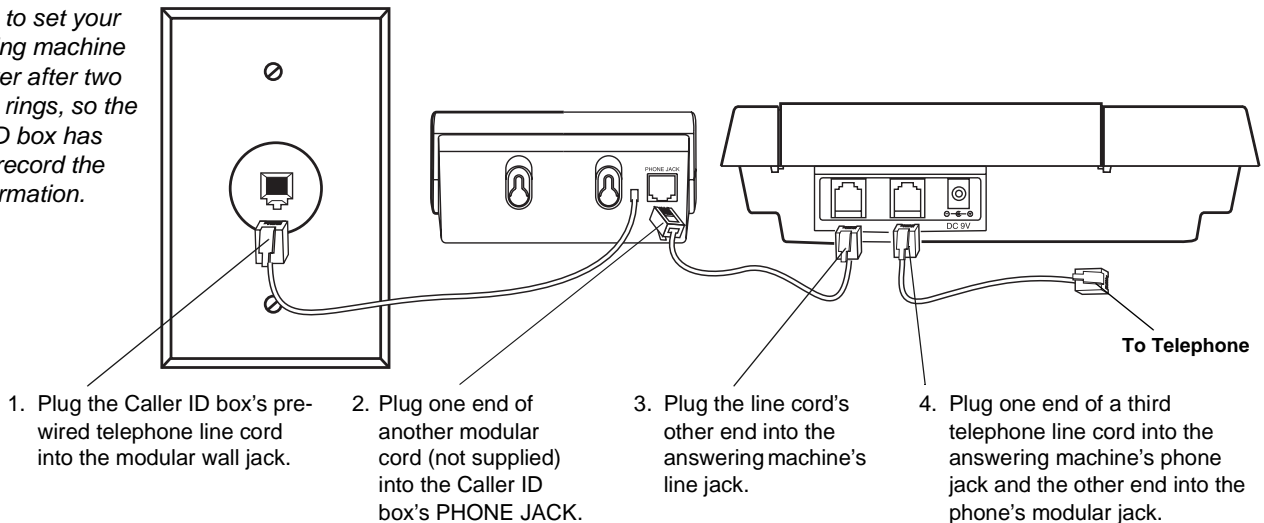

Connecting to a Two-Line Phone

To record information about calls received on a two-line phone, you can connect two Caller ID boxes using a triplex adapter (not supplied, available at RadioShack). Each Caller ID box only records information about calls received on the line to which it is connected.

Your modular phone jack must be an RJ14 jack wired for two phone lines.

1. Disconnect the telephone line cord from the modular phone jack on the wall, and plug it into the L1 + L2 jack on the triplex adapter.
2. Plug the triplex adapter into the modular phone jack.
3. Plug the pre-wired telephone line cord from your Caller ID box into either L1 or L2 on the triplex adapter.
4. Repeat Step 3 to connect another Caller ID box to the other available jack (L1 or L2) on the triplex adapter.

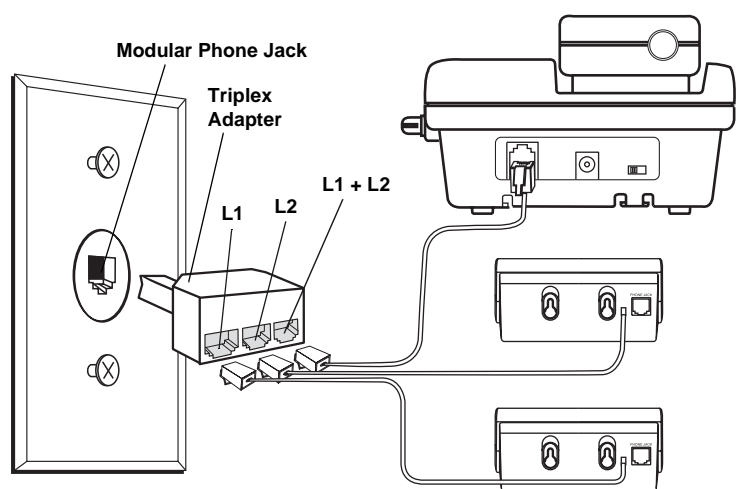

MOUNTING THE CALLER ID BOX

You can set the Caller ID box flat on a desk, shelf or table, or mount the Caller ID box on a wall.

On a Wall

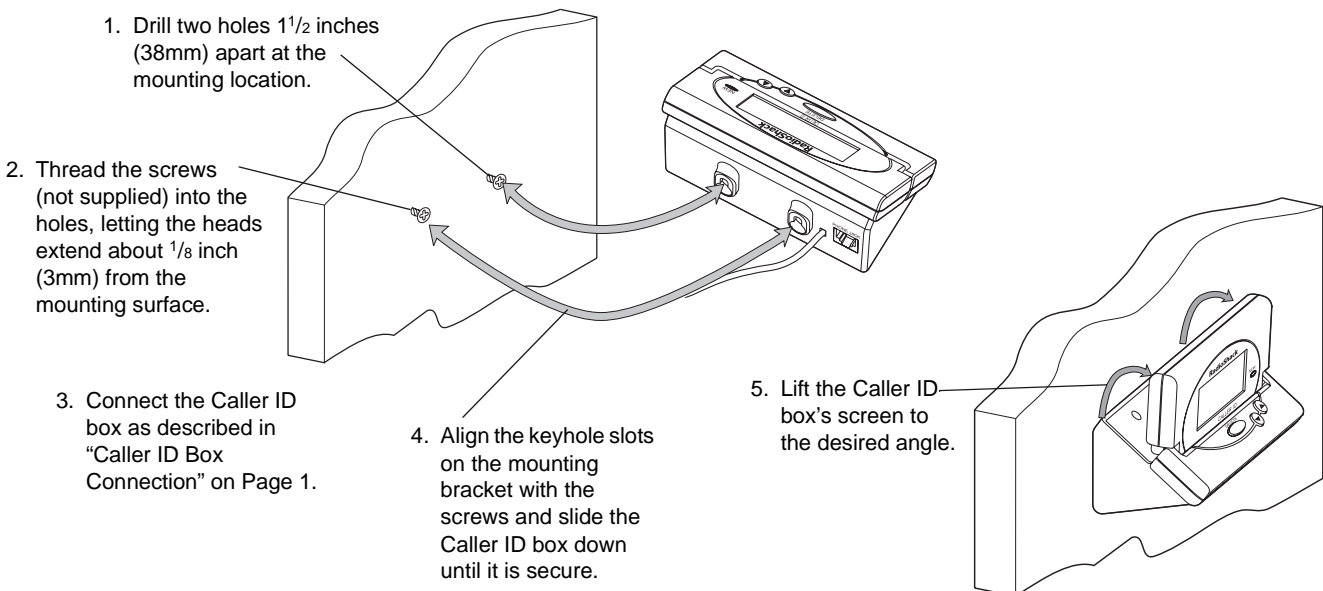

SETTING UP THE CALLER ID

Be sure to peel the film off the screen before using your Caller ID box.

1. When the time appears, hold down ▼ and ▲ at the same time until **ENTER LANGUAGE** and then **ENG ESP FRA** appear. **ENG** flashes.
2. Press ▼ or ▲ to select the desired language. Press **DELETE** to confirm. **LCD CONTRAST** and **1 2 3 4 5** appear, and **3** flashes.
3. Press ▼ or ▲ to select the contrast level (from 1 – 5). Press **DELETE** to confirm. **ENTER AREA CODE**, and **---** appears, and the first **_** flashes.
4. Press ▼ or ▲ to select the area code. Press **DELETE** to confirm the selection.
5. Repeat Step 4 to set the second and third digit.
6. **ENTER TIME DATE** appears and the hour digit flashes.
7. Press ▼ or ▲ to select the desired hour. Press **DELETE** to confirm. **AM** appears for an AM hour and **PM** appears for a PM hour.
8. Repeat Step 7 to set the minutes, month and date. ☑

RECEIVING CALLS

During an incoming call, **NEW** appears and the red New Call light flashes while the phone is ringing. The number of new and total calls appear. The red light flashes slowly, until all calls are reviewed. ☑

- If only the caller's phone number is received, the caller's phone number with the call time and date appear.
- If an incorrect, invalid or incomplete signal is received, **- LINE ERROR -** appears.
- If the name and number are unlisted, **- PRIVATE CALL -** appears with the call time and date.
- If the name and number are not available, **- UNAVAILABLE -** appears with the call time and date.
- For long distance calls, **LONG DISTANCE** appears.

REVIEWING CALL RECORDS

Each call record includes the time and date of the call, the call number (determined by the order in which the calls are received), the caller's telephone number, and the caller's name (if available).

1. Press ▼ or ▲ to review the calls. ☑
Once you have viewed all the new calls, **END OF NEW CALL** appears.
After you view all the saved calls, **END OF LIST** appears.
2. Press ▼ or ▲ to view them again.

DELETING CALL RECORDS

Deleting a Single Record

1. Press ▼ or ▲ until you see the record you want to delete.
2. Press **DELETE** twice to delete the record. The remaining call records are renumbered automatically.

Deleting All Records

1. After reviewing all new messages, press and hold **DELETE** for about 3 seconds. **ERASE ALL CALLS?** appears.
2. While **ERASE ALL CALLS?** appears, press **DELETE** again. **- NO CALLS -** appears.

To cancel deletion, do not press any buttons. After about 20 seconds, **ERASE ALL CALLS?** disappears.

CARE

Keep the Caller ID box dry; if it gets wet, wipe it dry immediately. Use and store the Caller ID box only in normal temperature environments. Handle the Caller ID box carefully; do not drop it. Keep the Caller ID box away from dust and dirt, and wipe it with a damp cloth occasionally to keep it looking new.

If your Caller ID box is not performing as it should, take it to your local RadioShack store for assistance. To locate your nearest RadioShack, use the store locator feature on RadioShack's website (www.radioshack.com), or call 1-800-The Shack (843-7422) and follow the menu options. Modifying or tampering with the Caller ID box's internal components can cause a malfunction and might invalidate its warranty and void your FCC authorization to operate it.

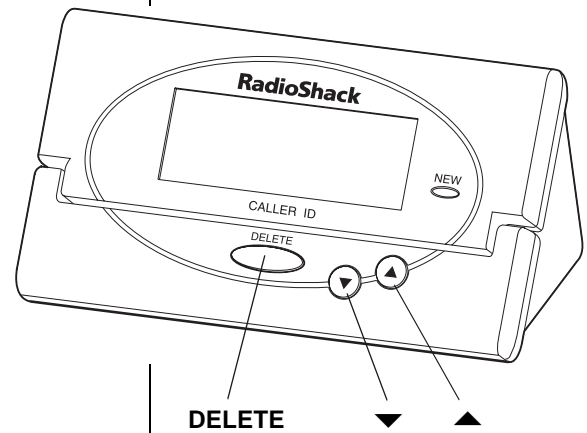

☑ **NOTE** ☑

Setting Up the Caller ID box
If no keys are pressed for 20 seconds, the Caller ID box exits setup.

Receiving Calls
The red New Call indicator flashes until all the new calls have been reviewed.

Reviewing Call Records

- If **RPT** appears, you have multiple new calls from the same number.
- If you receive a call from a number previously stored in memory, the old record's data is replaced with the new call's time and date, and **NEW** appears.

Limited Ninety-Day Warranty

This product is warranted by RadioShack against manufacturing defects in material and workmanship under normal use for ninety (90) days from the date of purchase from RadioShack company-owned stores and authorized RadioShack franchisees and dealers. EXCEPT AS PROVIDED HEREIN, RadioShack MAKES NO EXPRESS WARRANTIES AND ANY IMPLIED WARRANTIES, INCLUDING THOSE OF MERCHANTABILITY AND FITNESS FOR A PARTICULAR PURPOSE, ARE LIMITED IN DURATION TO THE DURATION OF THE WRITTEN LIMITED WARRANTIES CONTAINED HEREIN. EXCEPT AS PROVIDED HEREIN, RadioShack SHALL HAVE NO LIABILITY OR RESPONSIBILITY TO CUSTOMER OR ANY OTHER PERSON OR ENTITY WITH RESPECT TO ANY LIABILITY, LOSS OR DAMAGE CAUSED DIRECTLY OR INDIRECTLY BY USE OR PERFORMANCE OF THE PRODUCT OR ARISING OUT OF ANY BREACH OF THIS WARRANTY, INCLUDING, BUT NOT LIMITED TO, ANY DAMAGES RESULTING FROM INCONVENIENCE, LOSS OF TIME, DATA, PROPERTY, REVENUE, OR PROFIT OR ANY INDIRECT, SPECIAL, INCIDENTAL, OR CONSEQUENTIAL DAMAGES, EVEN IF RadioShack HAS BEEN ADVISED OF THE POSSIBILITY OF SUCH DAMAGES.

Some states do not allow limitations on how long an implied warranty lasts or the exclusion or limitation of incidental or consequential damages, so the above limitations or exclusions may not apply to you.

In the event of a product defect during the warranty period, take the product and the RadioShack sales receipt as proof of purchase date to any RadioShack store. RadioShack will, at its option, unless otherwise provided by law: (a) correct the defect by product repair without charge for parts and labor; (b) replace the product with one of the same or similar design; or (c) refund the purchase price. All replaced parts and products, and products on which a refund is made, become the property of RadioShack. New or reconditioned parts and products may be used in the performance of warranty service. Repaired or replaced parts and products are warranted for the remainder of the original warranty period. You will be charged for repair or replacement of the product made after the expiration of the warranty period.

This warranty does not cover: (a) damage or failure caused by or attributable to acts of God, abuse, accident, misuse, improper or abnormal usage, failure to follow instructions, improper installation or maintenance, alteration, lightning or other incidence of excess voltage or current; (b) any repairs other than those provided by a RadioShack Authorized Service Facility; (c) consumables such as fuses or batteries; (d) cosmetic damage; (e) transportation, shipping or insurance costs; or (f) costs of product removal, installation, set-up service adjustment or reinstallation.

This warranty gives you specific legal rights, and you may also have other rights which vary from state to state.

RadioShack Customer Relations, 200 Taylor Street, 6th Floor, Fort Worth, TX 76102

12/99

THE FCC WANTS YOU TO KNOW

This equipment has been tested and found to comply with the limits for a Class B digital device, pursuant to Part 15 of the *FCC Rules*. These limits are designed to provide reasonable protection against harmful interference in a residential installation. This equipment generates, uses, and can radiate radio frequency energy and, if not installed and used in accordance with the instructions, may cause harmful interference to radio communications.

However, there is no guarantee that interference will not occur in a particular installation. If this equipment does cause harmful interference to radio or television reception, which can be determined by turning the equipment off and on, the user is encouraged to try to correct the interference by one or more of the following measures:

- Reorient or relocate the receiving antenna.
- Increase the separation between the equipment and receiver.
- Connect the equipment into an outlet on a circuit different from that to which the receiver is connected.
- Consult your local RadioShack store or an experienced radio/TV technician for help.
- If you cannot eliminate the interference, the FCC requires that you stop using your Caller ID box.

Changes or modifications not expressly approved by RadioShack may cause interference and void the user's authority to operate the equipment.

FCC STATEMENT

Your Caller ID box complies with Part 68 of *FCC Rules* and the requirements adopted by the ACTA. On the bottom of this product is a label with this product's FCC Product Identification number in the format *US: AAOND01B433902*. If requested, you must provide this information to the telephone company.

You must not connect your Caller ID box to:

- *coin-operated systems*
- *most electronic key telephone systems*

Your Caller ID box is not intended to be used with party-line systems. Connection to party line service is subject to state tariffs. Contact the state public utility commission, public service commission, or corporation commission for information.

We have designed your Caller ID box to conform to federal regulations, and you can connect it to most telephone lines. However, each Caller ID box (and each device, such

as a telephone or answering machine) that you connect to the telephone line draws power from the telephone line. We refer to this power draw as the device's ringer equivalence number, or REN on the bottom of your Caller ID box.

If you use more than one phone or other device on the line, add up all of the RENs. If the total is more than five (three in rural areas), your telephones might not ring. If ringer operation is impaired, remove a device from the line.

In the unlikely event that your phone causes problems on the phone line, the phone company can temporarily discontinue your service. If this happens, the phone company attempts to notify you in advance. If advance notice is not practical, the phone company notifies you as soon as possible and advises you of your right to file a complaint with the FCC.

Also, the phone company can make changes to its lines, equipment, operations, or procedures that could affect the operation of this Caller ID box. The telephone company notifies you of these changes in advance, so you can take the necessary steps to prevent interruption of your telephone service.

If your home has specially wired alarm equipment connected to the telephone line, be sure that installing the Caller ID box does not disable your alarm equipment. If you have questions about what will disable your alarm equipment, contact your telephone company or a qualified installer.

SURGE PROTECTION

Your Caller ID box has built-in protection circuits to reduce the risk of damage from surges in telephone line and power line current. These protection circuits meet or exceed the FCC requirements. However, lightning striking the Caller ID box or power lines can damage your Caller ID box.

Lightning damage is not common. Nevertheless, if you live in an area that has severe electrical storms, we suggest that you unplug your phone when storms approach to reduce the possibility of damage.