

Extended Ethernet

AT-MC601
AT-MC602

Installation and User's Guide



Copyright © 2004 Allied Telesis K.K.
www.alliedtelesyn.com

All rights reserved. No part of this publication may be reproduced without prior written permission from Allied Telesis K.K.

Microsoft is a registered trademark of Microsoft Corporation, Netscape Navigator is a registered trademark of Netscape Communications Corporation. All other product names, company names, logos or other designations mentioned herein are trademarks or registered trademarks of their respective owners.

Allied Telesis K.K. reserves the right to make changes in specifications and other information contained in this document without prior written notice. The information provided herein is subject to change without notice. In no event shall Allied Telesis K.K. be liable for any incidental, special, indirect, or consequential damages whatsoever, including but not limited to lost profits, arising out of or related to this manual or the information contained herein, even if Allied Telesis K.K. has been advised of, known, or should have known, the possibility of such damages.

Electrical Safety and Emission Statement

Standards: This product meets the following standards.



Warning: In a domestic environment this product may cause radio interference in which case the user may be required to take adequate measures.

RFI Emission

EN55022 ClassA, FCC Part15 ClassA  1

Immunity

EN55024

Electrical Safety

EN60950, UL60950, FCC Part68  3

Important: Appendix C contains translated safety statements for installing this equipment. When you see the , go to Appendix C for the translated safety statement in your language.

Wichtig: Anhang C enthält übersetzte Sicherheitshinweise für die Installation dieses Geräts. Wenn Sie  sehen, schlagen Sie in Anhang C den übersetzten Sicherheitshinweis in Ihrer Sprache nach.

Viktig: Tillæg C indeholder oversatte sikkerhedsadvarsler, der vedrører installation af dette udstyr. Når De ser symbolet , skal De slå op i tillæg C og finde de oversatte sikkerhedsadvarsler i Deres eget sprog.

Belangrijk: Appendix C bevat vertaalde veiligheidsopmerkingen voor het installeren van deze apparatuur. Wanneer u de  ziet, raadpleeg Appendix C voor vertaalde veiligheidsinstructies in uw taal.

Important: L'annexe C contient les instructions de sécurité relatives à l'installation de cet équipement. Lorsque vous voyez le symbole , reportez-vous à l'annexe C pour consulter la traduction de ces instructions dans votre langue.

Tärkeää: Liite C sisältää tämän laitteen asentamiseen liittyvät käännetyt turvaohjeet. Kun näet -symbolin, katso käännettyä turvaohjetta liitteestä C.

Importante: l'Appendice C contiene avvisi di sicurezza tradotti per l'installazione di questa apparecchiatura. Il simbolo , indica di consultare l'Appendice C per l'avviso di sicurezza nella propria lingua.

Viktig: Tillegg C inneholder oversatt sikkerhetsinformasjon for installering av dette utstyret. Når du ser , åpner du til Tillegg C for å finne den oversatte sikkerhetsinformasjonen på ønsket språk.

Importante: O Anexo C contém advertências de segurança traduzidas para instalar este equipamento. Quando vir o símbolo , leia a advertência de segurança traduzida no seu idioma no Anexo C.

Importante: El Apéndice C contiene mensajes de seguridad traducidos para la instalación de este equipo. Cuando vea el símbolo , vaya al Apéndice C para ver el mensaje de seguridad traducido a su idioma.

Obs! Bilaga C innehåller översatta säkerhetsmeddelanden avseende installationen av denna utrustning. När du ser , skall du gå till Bilaga C för att läsa det översatta säkerhetsmeddelandet på ditt språk.

Contents

Electrical Safety and Emission Statement 3

Preface	6
How This Guide is Organized	6
Document Conventions	7
Contacting Allied Telesyn Technical Support	8
Online Support 8	
E-mail and Telephone Support 8	
Returning Products 8	
For Sales or Corporate Information 8	
Obtaining Management Software Updates 8	

Chapter 1

Product Description	9
Summary of Features	9
Overview	10
Location of Components	11
Hardware Features	12
VDSL Line Port	12
PSTN Port	13
10/100 Mbps Twisted Pair Ethernet Port	13
Status LEDs.....	15
MGMT Port.....	15
Management Cable	15
DC Power Supply Input Port	16
External AC/DC Power Adapter.....	16
Software Features	17

Chapter 2

Installation	18
Installation Safety Precautions	19
Additional Compliance Warning Statements.....	20
Selecting a Site for the Network Extender	21
Cables Not Included	22
Unpacking the Network Extender	23
Installing the AT-MC601 Subscriber Unit	24
Using the Subscriber Unit on a Desktop.....	24
Wall-Mounting the Subscriber Unit.....	24

Cabling the Subscriber Unit..... 26
Powering On the Subscriber Unit..... 27
Installing the AT-MC602 Provider Unit 28
 Using the Provider Unit on a Desktop..... 28
 Wall-Mounting the Provider Unit..... 29
 Grounding the Provider Unit 30
 Rack-Mounting the Provider Unit 31
 Cabling the Provider Unit..... 32
 Powering On the Provider Unit 33
Warranty Registration 34

Chapter 3

Configuration 35
Starting a Configuration Session 36
 Downloading Software Updates 36
 Cabling Preparations..... 36
 Opening the Configuration Software..... 37
Configuring the Provider Unit 38
 Configuration..... 38
 VDSL Status 41
 Ethernet Status 43
Configuring the Subscriber Unit 45

Chapter 4

Troubleshooting 47
 LEDs 47
 Error Messages 48

Appendix A

Default Configuration Settings 51

Appendix B

Technical Specifications 52
Physical Specifications 52
Environmental Specifications 52
Power Specifications 52
Safety and Electromagnetic Compatibility Certifications 53

Appendix C

Translated Electrical Safety and Emission Information 54

Preface

This guide contains instructions on how to install and configure the AT-MC601 and AT-MC602 Extended Ethernet units.

How This Guide is Organized

This manual contains the following chapters and appendices:

Chapter 1, Product Description, describes the features and components of the network extenders.

Chapter 2, Installation, contains installation instructions for each unit.

Chapter 3, Configuration, explains how to use the configuration software. The AT-S57 software is used to configure the network extenders.

Chapter 4, Troubleshooting, provides information on how to resolve common problems that might occur with the network extenders.

Appendix A, Default Settings, lists the default software settings.

Appendix B, Technical Specifications, lists the technical specifications for the network extenders.

Appendix C, Translated Electrical Safety and Emission Information, contains multi-language translations of the warnings and cautions in the manual.

Document Conventions

This document uses the following conventions:

Note

Notes provide additional information.



Warning

Warnings inform you that performing or omitting a specific action may result in bodily injury.



Caution

Cautions inform you that performing or omitting a specific action may result in equipment damage or loss of data.

Contacting Allied Telesyn Technical Support

This section provides Allied Telesyn contact information for technical support as well as sales or corporate information.

Online Support

You can request technical support online by accessing the Allied Telesyn Knowledge Base from the following web site:

<http://kb.alliedtelesyn.com>. You can use the Knowledge Base to submit questions to our technical support staff and review answers to previously asked questions.

E-mail and Telephone Support

For Technical Support via E-mail or telephone, refer to the Support & Services section of the Allied Telesyn web site:

<http://www.alliedtelesyn.com>.

Returning Products

Products for return or repair must first be assigned a Return Materials Authorization (RMA) number. A product sent to Allied Telesyn without a RMA number will be returned to the sender at the sender's expense.

To obtain a RMA number, contact Allied Telesyn's Technical Support at our web site: **<http://www.alliedtelesyn.com>**

For Sales or Corporate Information

You can contact Allied Telesyn for sales or corporate information at our web site: <http://www.alliedtelesyn.com>. To find the contact information for your country, select Contact Us then Worldwide Contacts.

Obtaining Management Software Updates

New releases of management software for our managed products can be downloaded from either of the following Internet sites:

- Allied Telesyn web site: **<http://www.alliedtelesyn.com>**
- Allied Telesyn FTP server: **<ftp://ftp.alliedtelesyn.com>**

If you would prefer to download new software from the Allied Telesyn FTP server from your workstation's command prompt, you will need FTP client software and you will be asked to log in to the server. Enter 'anonymous' as the user name and your email address for the password.

Chapter 1

Product Description

The AT-MC601, AT-MC602 Extended Ethernet products are designed to transmit data at very high speeds over unshielded pairs of copper wires using VDSL technology on your existing telephone line.

Summary of Features

- VDSL (Very high-bit-rate Digital Subscriber) Line port
- PSTN (Public Switched Telephone Network) port
- 10/100 Mbps Ethernet port with an RJ-45 connector
- Auto MDI/MDI-X
- Auto-Negotiation for speed and duplex mode (IEEE 803.3u-compliant)
- Status LEDs
- Management port
- AT-S57 configuration software
- 12V DC external power supply input port

Overview

These devices can be used in multi-dwelling units (MDU), multi-tenant buildings (MTU), and in the hospitality industry, such as airports, hotels, and convention centers.

These units are sold in pairs with the AT-MC601 functioning as the subscriber and the AT-MC602 functioning as the provider. In an MDU, such as a university dormitory, the subscriber unit would be installed in each room and connected to a provider unit through the telephone outlet. Each AT-MC602 or provider unit would be located in the building wiring closet.

The AT-MC601 Extended Ethernet unit can be used as a desktop or wallmount device while the AT-MC602 can be either installed in an AT-MCR12 chassis, used as a desktop device, or mounted onto the wall, provided that the chassis is connected to an appropriate ground rod. Refer to "Installing the AT-MC602 Provider Unit" on page 28" for installation details. These units are easy to install. They can be configured and managed through the MGMT port using the software provided on the installation CD.

When both the AT-MC601 Subscriber and the AT-MC602 Provider have been installed, the network extender system topology shown in Figure 1 is complete.

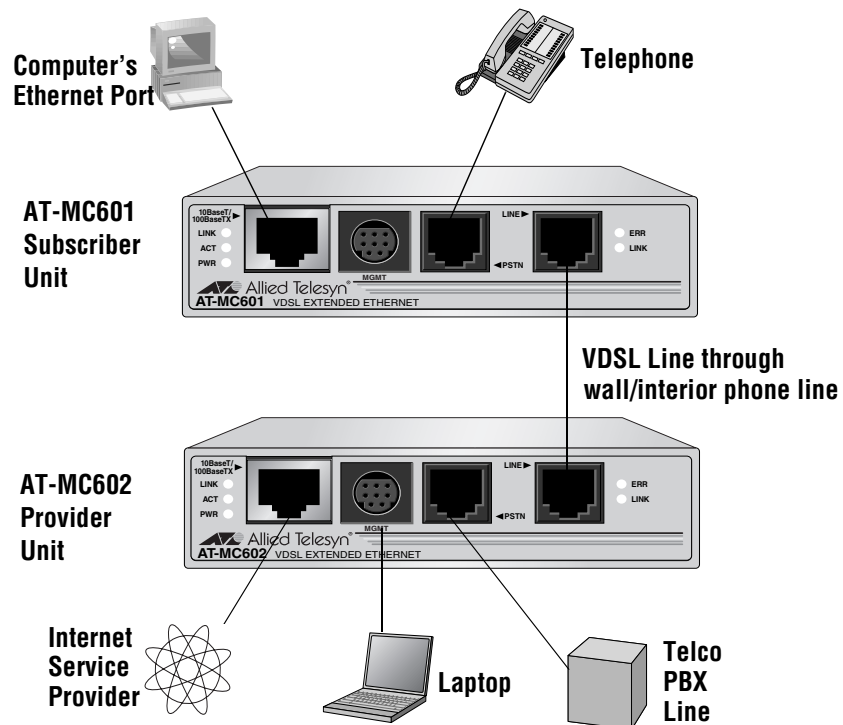
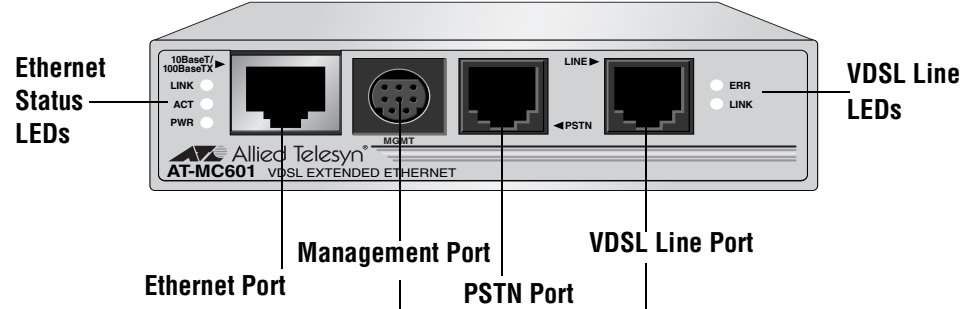

Figure 1 Network Extender System Topology

Location of Components

Figure 2 illustrates the front panels of the AT-MC601 and AT-MC602 network extenders.

AT-MC601



AT-MC602

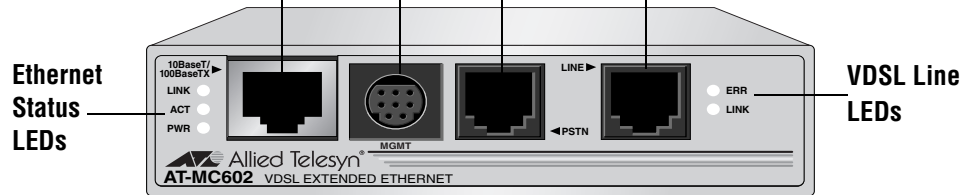
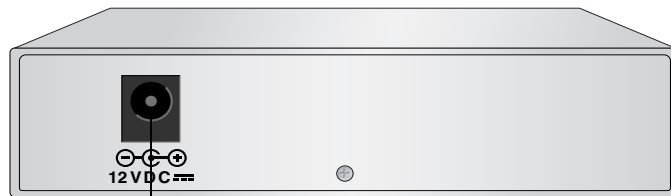

Figure 2 Front Panels

Figure 3 illustrates the rear panels of the AT-MC601 and AT-MC602 network extenders.

AT-MC601



DC Power Supply Port

AT-MC602

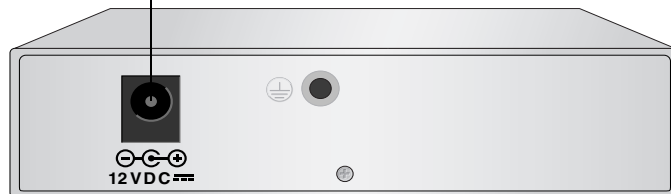

Figure 3 Rear Panels

Hardware Features

The following sections describe these hardware features of the AT-MC601 and AT-MC602 network extenders:

- VDSL Line port
- PSTN port
- 10/100 Mbps twisted pair Ethernet port
- Status LEDs
- Management port
- Management cable
- DC power supply input port
- External AC/DC power adapter

VDSL Line Port

The VDSL Line port allows you to connect the AT-MC601 Subscriber unit to a telephone jack (wall outlet) and the AT-MC602 Provider unit to the inside phone line at the wiring closet. The two units need to be within 1,200 meters of each other in order for the port to operate properly. The port transmits voice data at a frequency of 300-3400Hz and Ethernet data at frequencies of 300 KHz to 8 MHz. This port features an RJ-11 connector.

Table 1 lists the RJ-11 port pinouts and their assignments.

Table 1 VDSL - RJ-11 Port Pinouts

Pin	Assignment
1	pass-through 6
2	pass-through 5
3	VDSL and phone ring
4	VDSL and phone tip
5	pass-through 2
6	pass-through 1

PSTN Port

The PSTN port allows you to connect the AT-MC601 Subscriber unit to a telephone and the AT-MC602 Provider unit to the outside telco box. This port features an RJ-11 connector.

Table 2 lists the RJ-11 port pinouts and their assignments.

Table 2 PSTN - RJ-11 Port Pinout

Pin	Assignment
1	pass-through 1/6
2	pass-through 2/5
3	phone ring
4	phone tip
5	pass-through 5/2
6	pass-through 6/1

10/100 Mbps Twisted Pair Ethernet Port

The AT-MC601 and AT-MC602 network extenders each have one twisted pair Ethernet port. The twisted pair ports feature RJ-45 connectors with a maximum operating distance of 100 meters (328 feet). For the port pinout details, refer to "RJ-45 Port Pinouts" on page 14.

Type of Cabling. The 10/100Base-TX twisted pair port on the AT-MC601 and AT-MC602 network extenders are designed to operate with Category 3 or better unshielded twisted pair cables. For 10 Mbps operation on the twisted pair ports, Category 3 or better 100 ohm unshielded twisted pair cabling is required. For 100 Mbps operation on the twisted pair ports, Category 5 and Enhanced Category 5 (5E) 100 ohm unshielded twisted pair cabling is recommended.

Auto MDI/MDI-X. An RJ-45 twisted pair port on a 10/100 Mbps Ethernet network device can have one of two possible wiring configurations: MDI or MDI-X. The RJ-45 port on a PC, router, or bridge is typically wired as MDI, while the twisted pair port on a switch or hub is usually MDI-X.

The AT-MC601 and AT-MC602 network extenders feature automatic MDI/MDI-X. Each port automatically determines the configuration of the port on the device to which it is connected and then configures itself appropriately. For example, if a port on a network extender is connected to a port on a bridge, which is typically wired as MDI, the port on the network extender automatically configures itself as MDI-X. This feature allows you to use either straight-through or crossover cables when connecting devices to the network extender.

Auto-Negotiation. The network extenders Auto-Negotiate the speed and duplex mode of the Ethernet link, so that the link comes up in the highest performance configuration supported by both ends.

Half- and Full-duplex Mode. Duplex mode refers to the way an end-node sends and receives data on the network. An end-node can operate in either half- or full-duplex mode, depending on its capabilities. An end-node that is operating in half-duplex mode can either send data or receive data, but it cannot do both at the same time. An end-node that is operating in full-duplex mode can send and receive data simultaneously. The best network performance is achieved when an end-node can operate at full-duplex, since the end-node is able to send and receive data simultaneously.

The AT-MC601 and AT-MC602 network extenders can operate in either half- or full-duplex mode. The network extender can operate with end-nodes capable of either half-duplex, full-duplex, or that can Auto-Negotiate the duplex mode. However, it is important to remember that the two end-nodes connected to the ports on the network extenders must be able to operate in the same duplex mode.

RJ-45 Port Pinouts. Figure 4 illustrates the pin assignments of an RJ-45 connector and port.

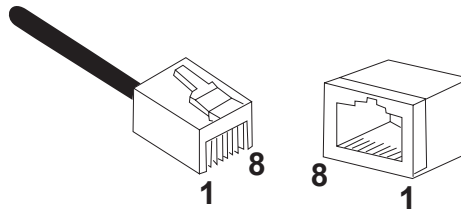

Figure 4 RJ-45 Connector and Port Pin Assignments

Table 3 lists the RJ-45 10Base-T/100Base-TX connector pins and their signals when the port is operating in either MDI or MDI-X configuration.

Table 3 RJ-45 Port Pinouts

Pin	MDI Signal	MDI-X Signal
1	TX+	RX+
2	TX-	RX-
3	RX+	TX+
6	RX-	TX-

Status LEDs

The AT-MC601 and AT-MC602 network extenders feature the status LEDs defined in Table 4.

Table 4 Status LEDs

LED	Color	Description
PWR	Green	Power is applied to the unit.
10/100Base-TX Port		
LINK	Green	A link has been established on the port.
ACT	Green	Data is being received on the ports.
LINE Port		
ERR	Green	An error has been detected on the port.
LINK	Green	A link has been established on the port.

MGMT Port

The management port features a 8-pin DIN connector for connecting the network extenders to your laptop or PC-compatible computer for configuration using the provided management cable.

Management Cable

The management cable included with the AT-MC602 Provider unit features a 9-pin RS-232 connector to attach to your computer and an 8-pin DIN connector to attach to the network extender.

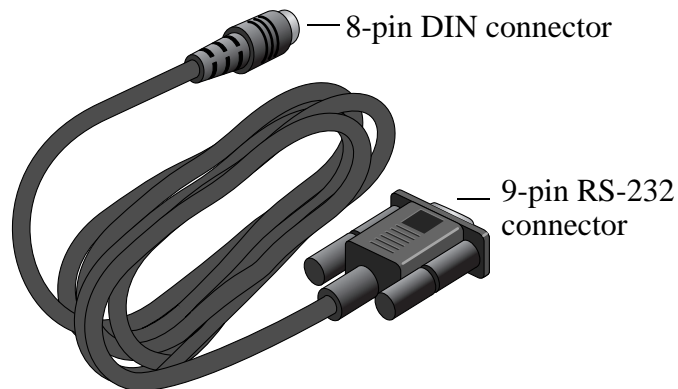

Figure 5 Management Cable

Table 5 lists the management cable connector pins and their signals.

Table 5 Management Cable Pinouts

RS-232 Pin	DIN Pin	Signal
1	1	Not Used
2	2	TXD
3	8	RXD
4	5	DSR
5	6	GND
6	3	DTR
7	4	CTS
8	7	RTS
9	(N/A)	Not Used

DC Power Supply Input Port

The network extender has a single DC power supply socket on the back panel. The unit does not have a power switch. To turn the network extender ON or OFF, you connect or disconnect the power cord.

External AC/DC Power Adapter

An external AC/DC power adapter is included with the network extender for desktop or wall-mount operation. The power adapter supplies 12V DC to the network extender. Allied Telesyn supplies an approved safety compliant AC power adapter specifically designed for each region the network extender is sold. Each type of power adapter has an unregulated output of 12V DC at 1A.

Software Features

The AT-S57 software used to configure the AT-MC601 and AT-MC602 network extenders has the following features:

- Determine the VDSL link status
- Set the upstream and downstream data transfer rates
- Monitor the status of the VDSL parameters on both the local and remote units
- Monitor the status of the Ethernet parameters on both the local and remote units
- Link recovery

Note

The features listed here are further described in "Configuration" on page 35.

Chapter 2

Installation

This chapter contains the installation procedures for the network extenders. The installation process is described in the following sections:

- Installation Safety Precautions
- Selecting a Site for the Network Extender
- Required Cables
- Unpacking the Network Extender
- Installing the AT-MC601 Subscriber Unit
- Installing the AT-MC602 Provider Unit
- Warranty Registration

Installation Safety Precautions

Please review the following safety precautions before you begin to install the network extenders. Refer to "Translated Electrical Safety and Emission Information" on page 54 for translated safety statements in your language.



Caution

Only use the power adapter supplied with the extender. The AT-MC602 can be installed stand alone or can be inserted in the AT-MCR12 chassis. In the last case, the AT-MC602 does not need the power adapter. ⚡ 4



Caution

Power cord is used as a disconnection device: To de-energize equipment, disconnect the power cord. ⚡ 5



Warning

Lightning Danger: Do not work on this equipment or cables during periods of lightning activity. ⚡ 6



Caution

Air vents: The air vents must not be blocked on the unit and must have free access to the room's ambient air for cooling. ⚡ 7



Caution

Operating Temperature: This product is designed for a maximum ambient temperature of 40°C. ⚡ 9



Caution

All Countries: Install this product in accordance with local and national electric codes. ⚡ 10

Additional Compliance Warning Statements

Additional telecommunication-related compliance warning statements used with the AT-MC601 and AT-MC602 Extended Ethernet units are listed below:



Warning

When using your telephone equipment, basic safety precautions should always be followed to reduce the risk of fire, electronic shock and injury to persons, including the following:

1. Do not use this product near water, for example, near a bathtub, washbowl, kitchen sink, or laundry tub in a wet basement or near a swimming pool.
 2. Avoid using a telephone (other than a cordless type) during an electrical storm. There may be remote risk of electric shock from lightning.
 3. Do not use the telephone to report a gas leak in the vicinity of the leak.
-



Caution

To reduce the risk of fire, use only No. 26 AWG or larger telecommunication line cord.



Caution

Mechanical Mounting: The attached rackmounting ears must be used to securely mount the device onto the rack.

Selecting a Site for the Network Extender

Observe the following requirements when choosing a site for your network extender:

- If you plan to install the AT-MCR12 in an equipment rack, check to be sure that the rack is safely secured and that it will not tip over. Devices in a rack should be installed starting at the bottom, with the heavier devices near the bottom of the rack.
- If you are installing the network extender on a table, be sure that the table is level and secure.
- The power outlet for the network extender should be located near the unit and should be easily accessible.
- The site should provide for easy access to the ports on the front of the network extender. This will make it easy for you to connect and disconnect cables, as well as view the LEDs.
- To allow proper cooling of the network extender, air flow around the unit and through its vents on the side should not be restricted.
- Do not place objects on top of the network extender.
- Do not expose the network extender to moisture or water.
- Make sure that the site is a dust-free environment.
- You should use dedicated power circuits or power conditioners to supply reliable electrical power to the network extenders.

Cables Not Included

The AT-MC601 and AT-MC602 network extenders require the three cables described in Table 6 below. These cables are not included with the network extenders.

Table 6 Cables

Port	Cable	Connector
Ethernet	Category 3 or better 100-ohm unshielded straight-through or crossover twisted pair cable	RJ-45
PSTN	standard telephone cable	RJ-11
VDSL Line	standard telephone cable	RJ-11

Unpacking the Network Extender

To unpack the network extender:

1. Remove all components from the shipping package and store the packaging material in a safe location.

Note

You must use the original shipping material if you need to return the unit to Allied Telesyn.

2. Place the network extender on a level, secure surface.
3. Make sure the following hardware components are included in your network extender package. If any item is missing or damaged, contact your Allied Telesyn sales representative for assistance.
 - One AT-MC601 or AT-MC602 Network Extender
 - Four protective feet
 - Two Phillips-head screws for wall-mounting
 - Two plastic anchors for wall-mounting
 - One cable lug
 - One M4 x 8mm screw
 - One power adapter
 - One management cable (provided for AT-MC602 model only)
 - Documentation and configuration software CD
 - Warranty and registration card

Installing the AT-MC601 Subscriber Unit

The AT-MC601 Subscriber unit will most likely be used as a stand-alone device, or can be used as a desktop device, or mounted onto a wall, using the keyholes on the bottom of the unit. The screws and plastic anchors used for mounting the unit are provided.

Using the Subscriber Unit on a Desktop

To use the Subscriber unit on a desktop, perform the following procedure:

1. Remove all equipment from the package and store the packaging material in a safe place.
2. Attach the four protective feet (provided) to each corner of the bottom of the unit, as illustrated in Figure 6.

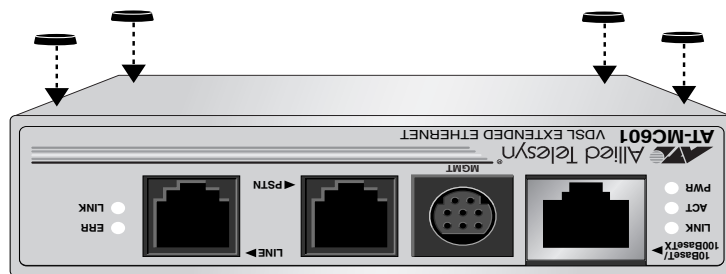

Figure 6 Attaching Protective Feet to the Subscriber Unit

Wall-Mounting the Subscriber Unit

The Subscriber unit can be mounted onto a wall using the keyholes on the bottom of the unit. The screws and plastic anchors used for mounting the unit are provided.

To wall-mount the Subscriber Unit, perform the following procedure:

1. If attached, remove the protective feet, data cables, and power cord from the unit.
2. Select a wall location for the device.

3. Install the screws and plastic anchors onto the wall, as shown in Figure 7.

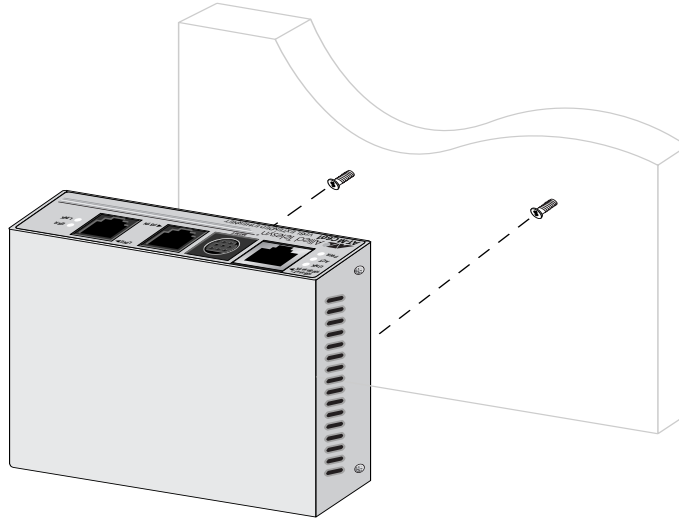

Figure 7 Installing the Screws and Plastic Anchors Onto The Wall

4. Position the switch onto the wall screws so that the ports are facing the ceiling, as shown in Figure 8.

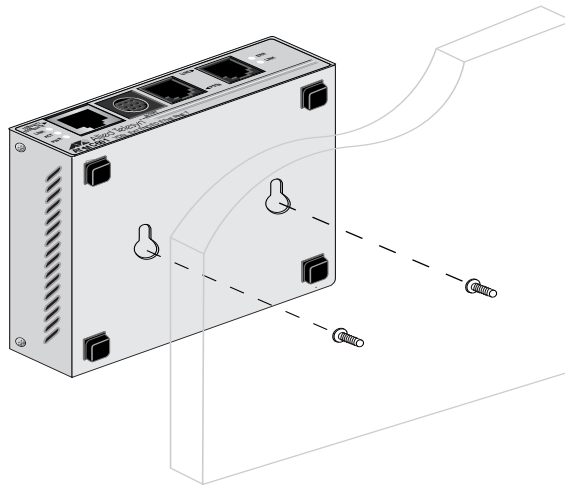

Figure 8 Positioning The Switch Onto The Wall Screws

Cabling the Subscriber Unit

To cable the Subscriber unit, perform the following steps:

1. First, connect the Ethernet cable from the Ethernet port to the Ethernet port on the computer, as shown in Figure 9.

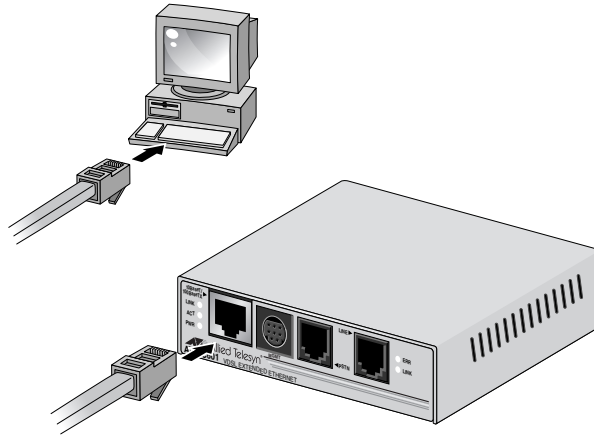

Figure 9 Ethernet to Computer

2. Then, connect a telephone line cable from the PSTN port to the telephone, as shown in Figure 10.

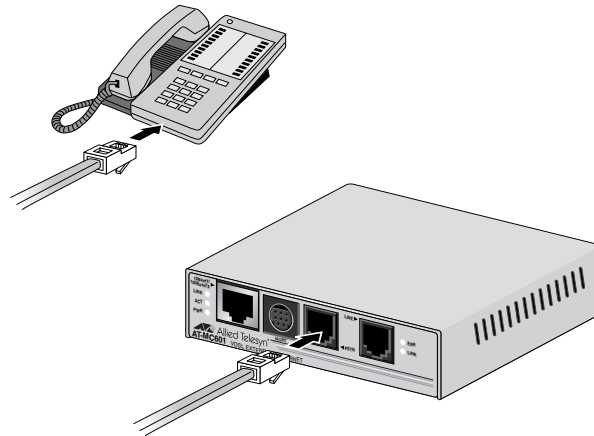

Figure 10 PSTN to Telephone

3. Next, connect a telephone line cable from the VDSL Line port to the wall/interior telephone line, as shown in Figure 11, so that the Subscriber unit can communicate with the Provider unit.

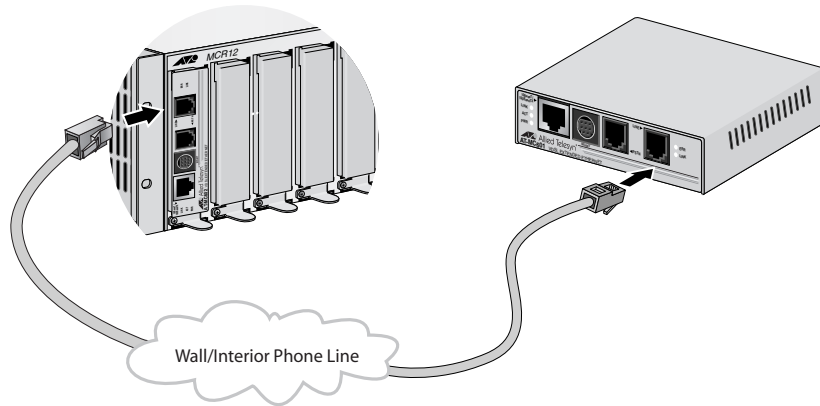

Figure 11 VDSL Line to Wall/Interior Phone Line

Note

The procedure for connecting the management cable is described in "Cabling Preparations" on page 36.

Powering On the Subscriber Unit

Power on the Subscriber unit using the power adapter provided, as shown in Figure 12.

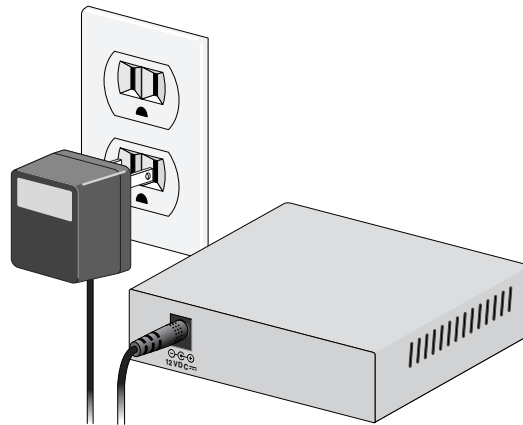

Figure 12 Power On The Subscriber Unit

Installing the AT-MC602 Provider Unit

The AT-MC602 Provider unit can be installed in an AT-MCR12 rackmount chassis, used as a desktop device, or mounted onto a wall using the keyholes on the bottom of the unit. The screws and plastic anchors used for mounting the unit are provided.



Warning

To prevent exposure to electric shock, the AT-MC602 Provider Unit must be installed in a **RESTRICTED ACCESS LOCATION** and performed by **QUALIFIED SERVICE PERSONNEL**.

Note

For Finland, Norway, and Sweden – When the AT-MC602 and the AT-MCR12 are used, a permanent ground conductor must be installed on the AT-MCR12 chassis.

For installation instructions of this ground conductor, refer to the *AT-MCR12 Media Converter Rackmount Chassis Installation Manual* (PN 613-10725-00).

Using the Provider Unit on a Desktop

To use the Provider unit on a desktop, perform the following procedure:

1. Remove all equipment from the package and store the packaging material in a safe place.
2. Attach the four protective feet (provided) to each corner of the bottom of the unit, as illustrated in Figure 6.

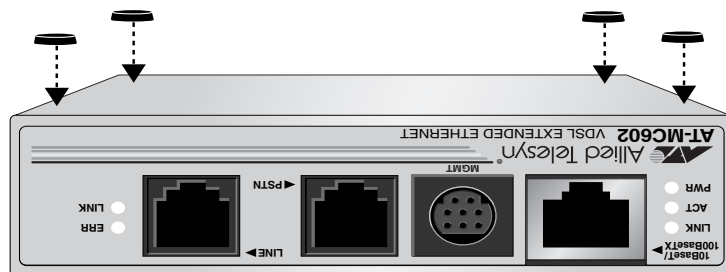

Figure 13 Attaching Protective Feet to the Provider Unit

Wall-Mounting the Provider Unit

The Provider unit can be mounted onto a wall using the keyholes on the bottom of the unit. The screws and plastic anchors used for mounting the unit are provided.

To wall-mount the Provider Unit, perform the following procedure:

1. If attached, remove the protective feet, data cables, and power cord from the unit.
2. Select a wall location for the device.
3. Install the screws and plastic anchors onto the wall, as shown in Figure 7.

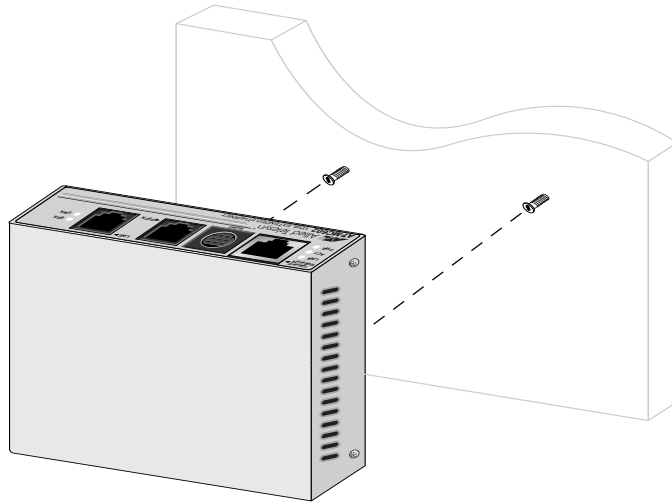

Figure 14 Installing the Screws and Plastic Anchors Onto The Wall

4. Position the switch onto the wall screws so that the ports are facing the ceiling, as shown in Figure 8.

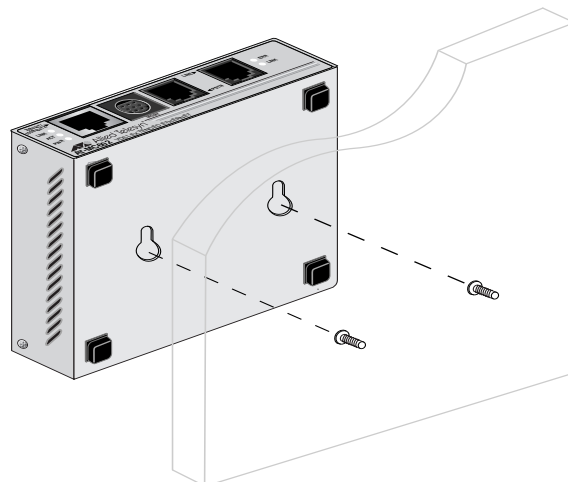

Figure 15 Positioning The Switch Onto The Wall Screws

Grounding the Provider Unit

When an AT-MC602 Provider unit is used as a standalone network extender, you must ground the unit to a ground point to ensure a safe and proper operation.

Grounding the chassis requires the following items:

- One cable lug (provided)
- One M4 x 8mm screw (provided)
- Crimping tool (not provided)
- One 12 AWG stranded wire or 14 AWG solid wire (not provided)



Warning

Make sure to attach the frame to ground **before** you power on the chassis.

To ground the unit to the ground point, perform the following procedure:

1. Use a crimping tool to affix the provided cable lug to one end of the 12 AWG bundled or 14 AWG solid ground wire.
2. Insert the M4 screw into the cable lug, as illustrated in Figure 16.

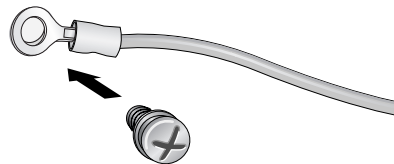

Figure 16 Inserting M4 Screw into the Cable Lug

3. Secure the cable lug with the M4 screw to the rear panel of the Provider unit, as illustrated in Figure 17.

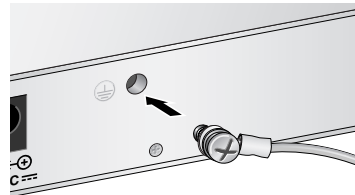

Figure 17 Securing Cable Lug with M4 Screw

4. Attach the other end of the ground wire to an appropriate ground (earth) rod of the building.

Rack-Mounting the Provider Unit

To install the Provider unit in an AT-MCR12 rackmount chassis, perform the following steps:

1. Attach the unit to one of the sliders that will hold the unit in the chassis, as shown in Figure 18.

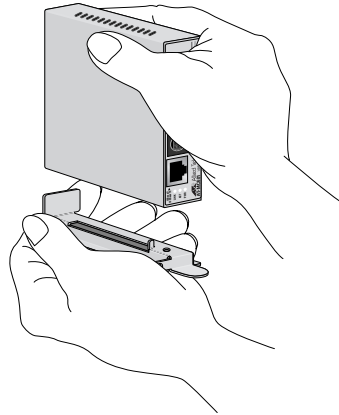

Figure 18 Rack Mount - Set on Slider

2. Then, set the slider in the chassis, as shown in Figure 19.

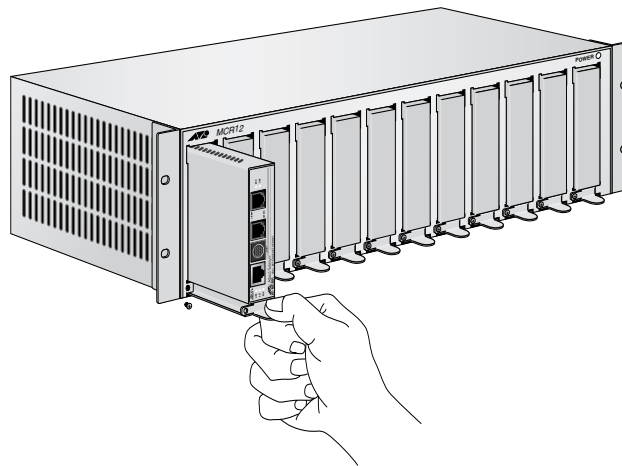

Figure 19 Rack Mount - Set in Rack

Cabling the Provider Unit

To cable the Provider unit, perform the following steps:

1. First, connect the Ethernet cable from the Ethernet port to the Service Provider box in your wiring closet, as shown in Figure 20.

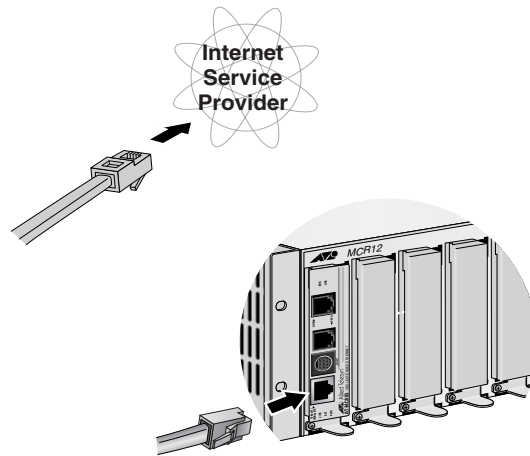

Figure 20 Ethernet to Internet Service Provider

2. Then, connect a telephone line cable from the PSTN port to the outside telco box, as shown in Figure 21.

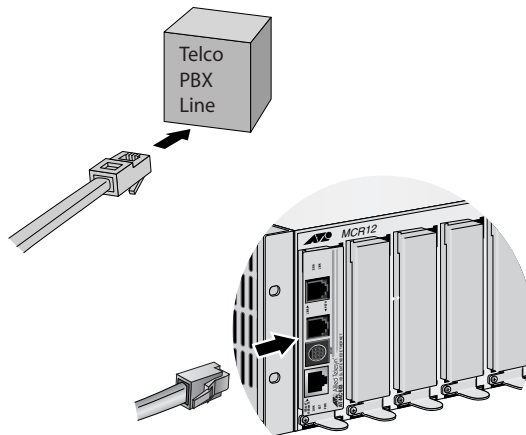

Figure 21 PSTN to Telco PBX Line

3. Next, connect a telephone line cable from the VDSL Line port to the wall/interior telephone line, as shown in Figure 22, so that the Provider unit can communicate with the Subscriber unit.

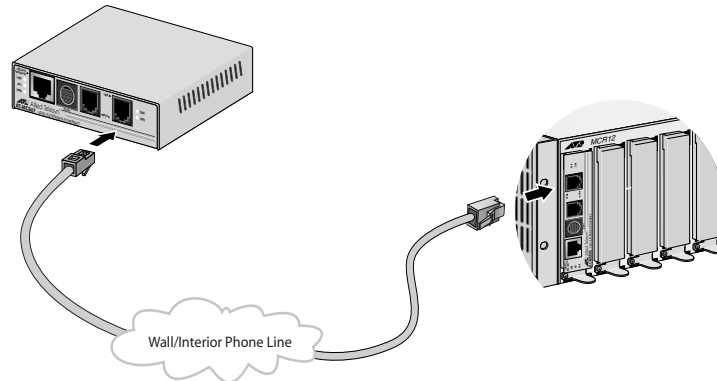

Figure 22 VDSL Line to Wall/Interior Phone Line

Note

The procedure for connecting the management cable is described in "Cabling Preparations" on page 36.

Powering On the Provider Unit

Powering on the AT-MC602 Provider Unit requires that the host equipment, AT-MCR12 rackmount chassis, is powered on as well.



Warning

The **QUALIFIED SERVICE PERSONNEL** must verify that the AT-MCR12 power cord is connected to the socket provided with the ground conductor.

If the power cord is not connected, the **QUALIFIED SERVICE PERSONNEL** must install a permanent ground connection using the bond stud on the rear panel of the AT-MCR12 chassis.

For detailed information on how to power on the AT-MCR12 unit, refer to the *AT-MCR12 Media Converter Rackmount Chassis Installation Manual*.

Warranty Registration

When you have finished installing the network extender, register your product by completing the enclosed warranty card and mailing it to Allied Telesyn.

Chapter 3

Configuration

The configuration software allows you to adjust and monitor the operating parameters of the media converter. Some of the functions that you can perform with the software include:

- Determine the VDSL link status
- Set the upstream and downstream data transfer rates
- Monitor the status of the VDSL parameters on both the local and remote units
- Monitor the status of the Ethernet parameters on both the local and remote units
- Link recovery

The AT-S57 configuration software is included on the Documentation CD included with the network extender. The default settings may be adequate for some networks and may not need to be changed. If this is true for your network, then you can use the network extenders by simply connecting the units to your network, as explained in "Installation" on page 18.

Note

The default settings for the configuration software can be found in **Appendix A** on page 51.

To actively configure a network extender by changing or adjusting its operating parameters, you must access the AT-S57 software while connected to the AT-MC602 Provider unit. The AT-S57 software has a menu interface that makes it very easy to use.

Starting a Configuration Session

Downloading Software Updates

In order to configure and manage your AT-MC601 and AT-MC602 VDSL network extenders, you need to download a copy of the configuration software onto the computers you will use to manage the units. The AT-S57 configuration software is included on the Documentation CD provided with the units.

New releases of the AT-S57 configuration software are available from the Allied Telesyn Web site at www.alliedtelesyn.com or from our FTP server at [ftp.alliedtelesyn.com](ftp://ftp.alliedtelesyn.com). To log on to the FTP server, enter “anonymous” for the user name and your email address for the password. Management software for the AT-MC601 and AT-MC602 VDSL network extenders will have “S57” as part of the file name.

Cabling Preparations

Once you have a copy of the software on your computer, connect the Provider unit to your computer using the management cable provided, as shown in Figure 23. Attach the 9-pin RS-232 end of the cable to the COM 1 or COM 2 port on your computer. Attach the 8-pin DIN end of the cable to the management port on the unit.

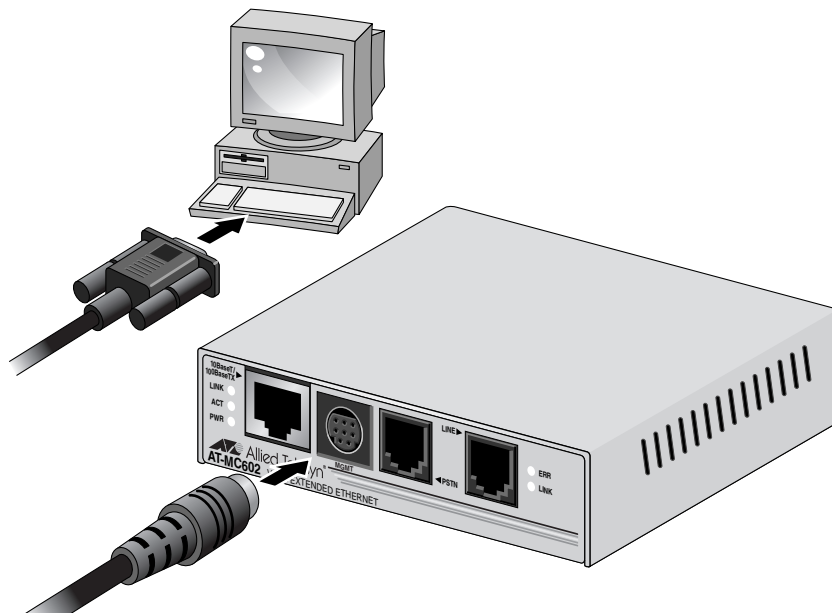

Figure 23 Connecting the Management Cable

If the network extender is not already on, power on the unit using the power cable provided. Refer to “Powering On the Subscriber Unit” on page 27 for further instructions on how to power on the unit.

Opening the Configuration Software

Open the configuration software by double-clicking the “ATS57” application icon, as you would with any other software program. The AT-MC60x Configurator pop-up will appear, as shown in Figure 24.

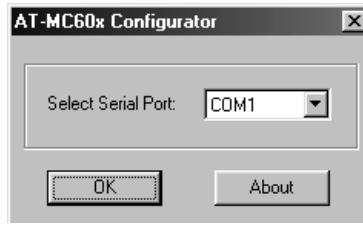

Figure 24 AT-MC60x Configurator

If you would like to verify that you are using the latest version of the configuration and management software, click the About button on the bottom right of the AT-MC60x Configurator pop-up. The About AT-MC60x Configurator pop-up will appear, as shown in Figure 25.

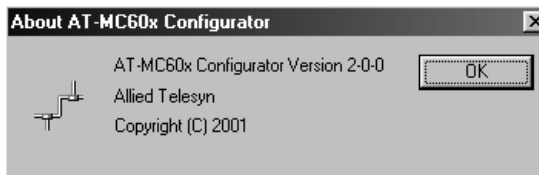

Figure 25 About AT-MC60x Configurator

Select the computer port you are using from the pull-down menu on the AT-MC60x Configurator pop-up and click OK.

If you are connected to the AT-MC602 Provider unit and want to configure the network extenders, continue with the next section, “Configuring the Provider Unit” on page 38. If you are connected to the AT-MC601 Subscriber unit to attempt link recovery, continue with “Configuring the Subscriber Unit” on page 45.

Configuring the Provider Unit

After performing the procedure described in the previous section, "Starting a Configuration Session" on page 36, if you are connected to the Provider unit, the AT-MC60x Configurator menu will appear. The Configurator bar at the top of the menu indicates whether or not the Provider unit has established an Ethernet link by displaying [link DOWN] or [link UP] in brackets.

The AT-MC60x Configurator menu has three screens: Configuration, VDSL Status, and Ethernet Status. The parameters on these screens are described below. Use the tabs at the top of the menu to toggle between these screens. When you have finished viewing or adjusting the parameters on the menu screens, click the Close button on the bottom right of the menu to exit from the configuration software.

Configuration The Configuration screen displayed in Figure 26 is shown first by default.

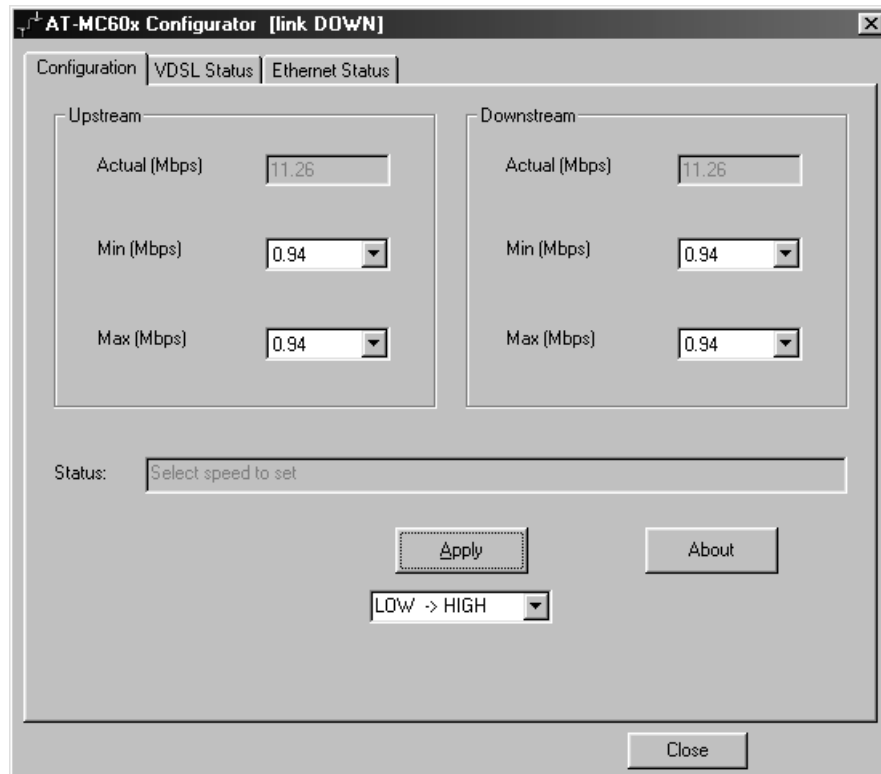

Figure 26 Configuration

The parameters on the Configuration screen are described below.

Upstream/Downstream

The upstream and downstream data transfer rate.

- Actual (Mbps)**
Displays the actual data transfer rate on the line. The software automatically detects this speed.
- Min (Mbps)**
Allows you to adapt the data transfer rate by setting a minimum speed.
- Max (Mbps)**
Allows you to adapt the data transfer rate by setting a maximum speed.

The maximum and minimum speeds in Mbps available in the pull-down menus are:

0.94	4.22
1.06	5.63
1.41	7.50
1.88	8.44
2.11	11.26
2.81	15.01
3.75	16.88 (upstream only)

Status

This field will display “Select speed to set” until you have selected data rates from the upstream and downstream pull-down menus and set the rates by clicking the Apply button. Then reports on the status of the attempt to configure the speeds selected from the upstream and downstream pull-down menus will appear in this field. A successful configuration attempt will cycle through the following status reports:

```
Looking for link status...
Checking signal/noise ratio
Loading a Configuration DS=1.41 US=2.81
    (This report will keep repeating with progressively higher
    upstream and downstream values until the set rate or the
    highest possible rate has been achieved.)
Saving config on EEPROM - S Side
Saving config on EEPROM - P Side
Done
```

The Configuration Saved pop-up shown in Figure 27 will appear when the set rate or the highest possible rate has been achieved.



Figure 27 Configuration Saved

An unsuccessful configuration attempt may include the following status reports:

- Loading defaults
- Can't read link status
- Done

These negative status reports may also be accompanied by error message pop-ups. Error messages are explained in "Troubleshooting" on page 47.

HIGH -> LOW/LOW -> HIGH

Allows you to choose the negotiation direction for the modem speed. The default and preferred direction is Low -> High. Choosing a negotiation direction determines how the modem searches for speeds. When set to Low -> High, the modem will start at minimum speeds and keeps negotiating progressively higher speeds until it has achieved its maximum speed for the connection.

Apply

Press the Apply button to set your data transfer rates and negotiation direction selections.

About

Use the About button to display the version number of the AT-S57 configuration software.

VDSL Status To view the VDSL Status screen, click on the VDSL Status tab at the top of the menu.

The VDSL Status screen is displayed in Figure 28.

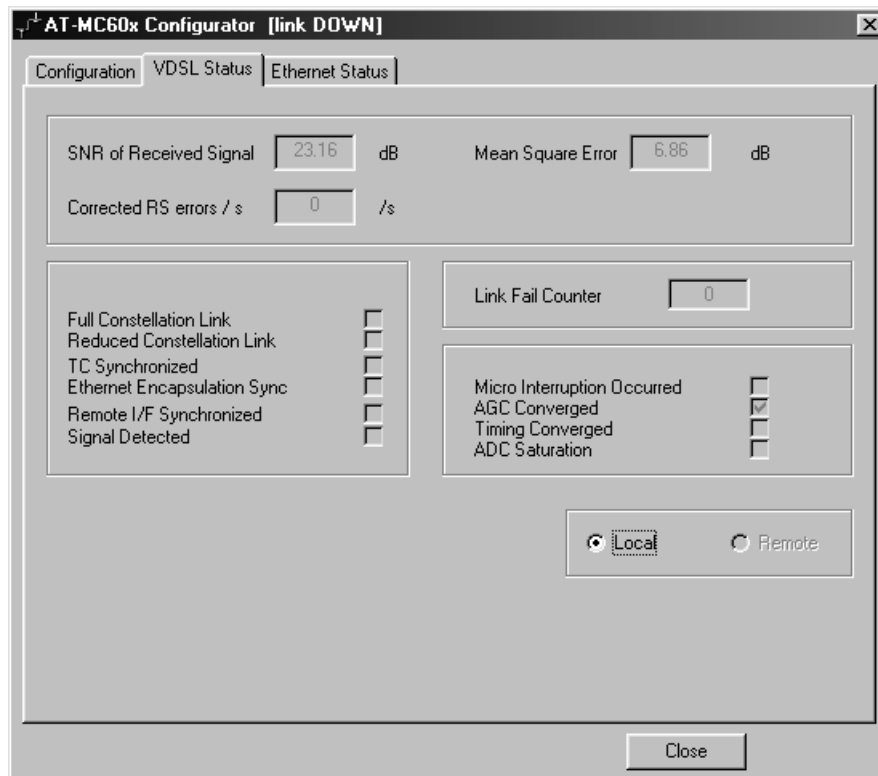

Figure 28 VDSL Status

The parameters on the VDSL Status screen are described below. These parameters are for viewing and monitoring purposes only. They cannot be changed manually.

SNR of Received Signal

The Signal-to-Noise Ratio on the VDSL line, measured in decibels. The SNR is a parameter of the constellation of the receive signal.

Corrected RS errors /s

Number of corrected Reed-Solomon errors per second.

Mean Square Error

An indication of the symbol error rate, measured in decibels.

Full Constellation Link

The highest possible QAM (Quadrature Amplitude Modulation) constellation, which enables the highest line rates.

Reduced Constellation Link

A lesser QAM constellation, causing reduced line rates. If the full constellation rate cannot be achieved because the received SNR is too low, then a reduced constellation link can be established and the software can automatically configure the Subscriber unit parameters.

TC Synchronized

Transmission convergence is synchronized.

Ethernet Encapsulation Sync

The process of encapsulating packets into frames at the VDSL link level is synchronized.

Remote I/F Synchronized

Remote interface is synchronized.

Signal Detected

The VDSL signal is being detected by the software.

Link Fail Counter

Number of unsuccessful link attempts.

Micro Interruption Occurred

A micro-interruption occurred.

AGC Converged

Automatic gain control has converged on the VDSL link.

Timing Converged

The timing acquisition function is converged. This only occurs on the Subscriber (remote) unit

ADC Saturation

Analog-to-digital converter has been overloaded with interference.

Local/Remote

Select Local to view the parameters for the Provider unit. Select Remote to view the parameters for the Subscriber unit. The Remote option will only be available when an active link has been established.

Ethernet Status

To view the Ethernet Status screen, click on the Ethernet Status tab at the top of the menu.

The Ethernet Status screen is displayed in Figure 29.

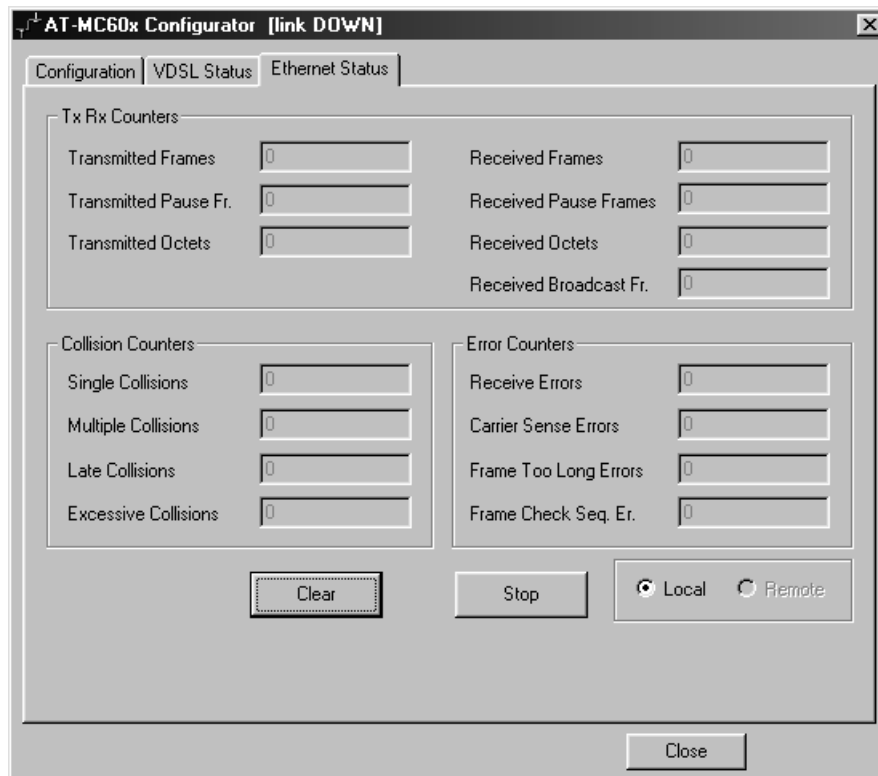

Figure 29 Ethernet Status

The parameters on the Ethernet Status screen are described below.

TxRx Counters

The data fields in this section indicate the number and type of frames that have been transmitted and received via the Ethernet link.

Collision Counters

The data fields in this section indicate the number and type of collisions that have occurred on the Ethernet link.

Error Counters

The data fields in this section indicate the number and type of errors that have occurred on the Ethernet link.

Clear

This button allows you to reset the counters, clearing the values previously recorded by the software.

Stop/Start

This button allows you to pause counting. When you press Stop, the counters remain at their present values. When you press Start, the counters continue adding to the values already recorded by the software.

Local/Remote

Select Local to view the parameters for the Provider unit. Select Remote to view the parameters for the Subscriber unit. The Remote option will only be available when an active link has been established.

Configuring the Subscriber Unit

In rare instances, you may need to use the configuration software on the Subscriber unit to attempt link recovery. If the configuration software detects a problem with the Subscriber unit while you are connected to the Provider unit, it will prompt you to use the software on the Subscriber unit by displaying a pop-up error message. On these occasions, follow the procedure described in "Starting a Configuration Session" on page 36 and then continue with the instructions in this section.

After you have selected the correct port and clicked the OK button, the AT-MC60x Configurator Select Mode screen will appear, as displayed in Figure 30.

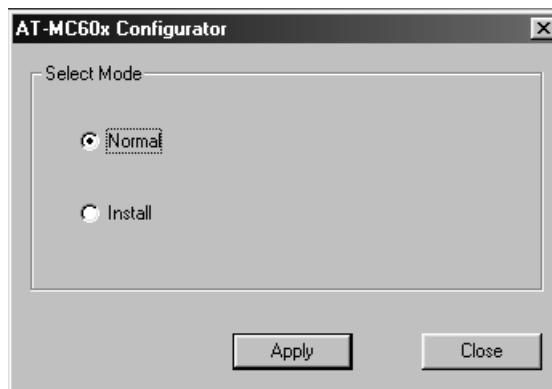

Figure 30 Select Mode

There are two options on the Select Mode screen: Normal and Install. These options are described below:

Normal

The Normal mode sets the units to operate under normal parameters. The units will attempt to establish a link using the parameters you set on the Configuration screen while connected to the Provider unit. See "Configuration" on page 38 for a description of the Configuration screen. Using the Normal mode will only allow the units to establish links that meet the criteria you have set. The disadvantage to using the Normal mode is that if either of the upstream or downstream speeds you have set are unattainable, the link attempt will fail because the units are not set to use the default parameters as back-ups.

Install

The Install mode enables a watchdog timer to monitor the link attempt process. If the network extenders are not able to establish a link using the parameters you set on the Provider unit within a reasonable amount of

time, a timeout will occur. After a timeout, the default configuration parameters will be used to establish a link with the highest possible speed. The default configuration parameters start at 0.94 Mbps upstream and downstream with negotiation set from Low -> High.

Select the option that corresponds to your mode choice and click the Apply button.

When the mode has been set, the AT-MC60x Configurator Done message will appear, as displayed in Figure 31.



Figure 31 Done Message

When you have finished setting the mode on the Subscriber unit, click the Close button on the bottom right of the AT-MC60x Configurator menu to exit from the configuration software.

Chapter 4

Troubleshooting

This chapter contains information on how to troubleshoot the AT-MC601 and AT-MC602 network extenders in the event a problem occurs.

Note

If after following the instructions in this chapter you are unable to resolve the problem, contact Allied Telesyn Technical Support for assistance. Refer to "Contacting Allied Telesyn Technical Support" on page 8 for information on how to contact our Technical Support Department.

- LEDs** Check the PWR LED on the front of the network extender. If the LED is OFF, indicating that the network extender is not receiving power, do the following:
- If the network extender is inserted in the AT-MCR12 chassis, make sure that the power cord is securely connected to the power source and to the power connector on the back panel of the AT-MCR12 chassis.
 - If the network extender stands alone, make sure that the provided adapter is securely connected to the power source and to the power connector on the back panel of the network extender.
 - Verify that the power outlet has power by connecting another device to it.
 - Try connecting the network extender to another power source.
 - Try using a different power cord or a different power adapter.
 - Check that the voltage from the power source is within the required levels for your region.

Verify that the ACT LED for each twisted pair port is ON. If a ACT LED is OFF, do the following:

- Verify that the end node connected to the port is powered ON and is operating properly.
- Check that the twisted pair cable is securely connected to the port on the network extender and to the port on the end node.
- Make sure that the twisted pair cable does not exceed 100 meters (328 feet).
- Verify that you are using the appropriate category of twisted pair cable: Category 3 or better for 10 Mbps operation, Category 5 and Category 5E for 100 Mbps operation.
- Make sure that the operating parameters of the port on the network extender are compatible with the end node to which the port is connected.

Error Messages

When using the configuration software, you may encounter the following error messages:

- “No answer from device,”** as shown in Figure 32



Figure 32 No Answer Error Message

This error message may occur when your computer is not responding, in which case you should re-start your computer and try again.

- “Communication error: the program will be closed. Verify serial connection and restart the program,”** as shown in Figure 33

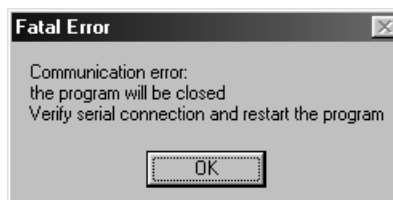

Figure 33 Communication Error Message

If you are unable to establish a configuration session with the network extender and receive this error message, check to be sure that the management cable is securely connected to the management port on the network extender and to the RS-232 port on the computer. Then make sure you are selecting the correct COM1 or COM2 port at the software prompt.

- ❑ **“Max speed cannot be lower than min speed: select different values”**

This error message occurs when you select a maximum speed that is lower than the set minimum speed during the selection of speed ranges on the rate adaptation section on the Configuration menu screen. Select a higher maximum value to correct the problem.

- ❑ **“P side must be connected to start this procedure” or “S side must be connected to start this procedure”**

These error messages occur when the management cable is connected to the wrong unit for the procedure you are trying to perform. This could happen if you switch the management cable between the units without closing the software window. Simply switch the management cable to the other unit to correct the problem.

- ❑ **“Can't read link status”**

This message occurs when the software cannot read the link status from the Provider side. Perform the procedure described in “Configuring the Subscriber Unit” on page 45 to see if link recovery on the Subscriber unit solves the problem.

- ❑ **“Please run this program on S side to set it in Install mode. If S side is already in install mode then configuration can not be achieved,”** as shown in Figure 34.

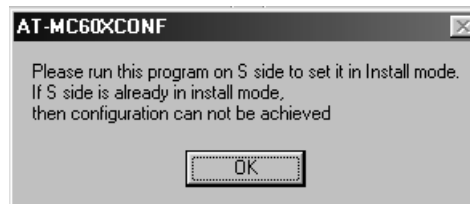

Figure 34 Run on S Side Error Message

This error message occurs when the Provider unit cannot achieve the link with the S or Subscriber side unit using the default speeds value. Set the Subscriber to Install Mode, as described in “Configuring the Subscriber Unit” on page 45.

- ❑ **“Configuration file was not found”**
- ❑ **“Syntax error in configuration file”**
- ❑ **“Configuration cannot be achieved”**

These last three error messages indicate a problem with the configuration software. Try re-loading the software onto your computer.

Appendix A

Default Configuration Settings

This appendix lists the AT-MC601 and AT-MC602 default settings.

Setting	Default
Provider Parameters Monitored	Local (Provider)
Speeds	
Upstream Max	.94 Mbps
Upstream Min	.94 Mbps
Downstream Max	.94 Mbps
Downstream Min	.94 Mbps
Flow	
Low to High	Selected
Ethernet Port	
Duplex Mode	Auto-Negotiate
Speed	Auto-Negotiate
MDI/MDI-X	Auto
Link Recovery	
Subscriber Unit Mode	Normal

Appendix B

Technical Specifications

Physical Specifications

Dimensions:	(W x D x H) 109 mm x 95 mm x 25 mm (4.29 in. x 3.74 in. x 0.98 in.)
Weight:	.27 kg (0.6 lbs)
Recommended Minimum Clearance on All Sides:	5.08 cm (2.0 in.)

Environmental Specifications

Operating Temperature:	0° C to 40° C (32° F to 104° F)
Storage Temperature:	-25° C to 70° C (-13° F to 158° F)
Operating Humidity:	5% to 90% (noncondensing)
Storage Humidity:	5% to 95% (noncondensing)
Operating Altitude:	3,000 m (approx. 10,000 ft)
Non-operating Altitude:	4,000 m (approx. 13,100 ft)

Power Specifications

Power Consumption:	6 Watts
Input Supply Current:	500 mA
Input Supply Voltage:	12V DC

Safety and Electromagnetic Compatibility Certifications

Emission: EN55022 ClassA, FCC Part15 ClassA

Immunity: EN55024

Safety: EN60950, UL60950, FCC Part68

Appendix C

Translated Electrical Safety and Emission Information

Important: This appendix contains multiple-language translations for the safety statements in this guide.

Wichtig: Dieser Anhang enthält Übersetzungen der in diesem Handbuch enthaltenen Sicherheitshinweise in mehreren Sprachen.

Vigtigt: Dette tillæg indeholder oversættelser i flere sprog af sikkerhedsadvarslerne i denne håndbog.

Belangrijk: Deze appendix bevat vertalingen in meerdere talen van de veiligheidsopmerkingen in deze gids.

Important: Cette annexe contient la traduction en plusieurs langues des instructions de sécurité figurant dans ce guide.

Tärkeää: Tämä liite sisältää tässä oppaassa esiintyvät turvaohjeet usealla kielellä.

Importante: questa appendice contiene traduzioni in più lingue degli avvisi di sicurezza di questa guida.

Viktig: Dette tillegget inneholder oversettelser til flere språk av sikkerhetsinformasjonen i denne veiledningen.

Importante: Este anexo contém traduções em vários idiomas das advertências de segurança neste guia.







Importante: Este apéndice contiene traducciones en múltiples idiomas de los mensajes de seguridad incluidos en esta guía.

Obs! Denna bilaga innehåller flerspråkiga översättningar av säkerhetsmeddelandena i denna handledning.

















Standards: This product meets the following safety standards.

- | | | |
|---|-------------------|--------------------------------------|
| 1 | RFI Emission | EN55022 Class A, FCC Part 15 Class A |
| 2 | Immunity | EN55024 |
| 3 | Electrical Safety | EN60950, UL60950, FCC Part 68 |

















Safety

- 4  Only use the power adapter supplied with the extender.
The AT-MC602 can be installed stand alone or can be inserted in the AT-MCR12 chassis. In the last case, the AT-MC602 does not need the power adapter.
- 5  **Caution:** Power cord is used as a disconnection device. To de-energize equipment disconnect the power cord.
- 6  **Lightning Danger**
Danger: Do not work on equipment or cables during periods of lightning activity.
- 7  Do not block air vents.
- 8  Do not connect a telephone line into the signal connector.
- 9  **Operating Temperature:** This product is designed for a maximum ambient temperature of 40 degrees C.
- 10  **All Countries:** Install product in accordance with local and National Electrical Codes.

Normen: Dieses Produkt erfüllt die Anforderungen der nachfolgenden Normen.

- | | | | |
|---|----------|------------------------|--|
|  | 1 | Hochfrequenzstörung | EN55022 Klasse A, FCC Part 15 Klasse A |
|  | 2 | Störsicherheit | EN55024 |
|  | 3 | Elektrische Sicherheit | EN60950, UL60950, FCC Part 68 |
- Sicherheit
- | | | | |
|---|-----------|--|--|
|  | 4 |  Bitte den Adapter nur mit dem mitgelieferten Extender benutzen.
Die AT-MC602 kann einzeln benutzt werden oder in der AT-MCR12 Einheit. Im letzteren Fall braucht der AT-MC602 keinen Adapter. | |
|  | 5 |  Vorsicht: Das netzkabel dient zum trennen der stromversorgung. Zur trennung vom netz, kabel aus der steckdose ziehen. | |
|  | 6 |  Gefahr Durch Blitzschlag
Gefahr: Keine Arbeiten am Gerät oder an den Kabeln während eines Gewitters ausführen. | |
|  | 7 |  Entlüftungsöffnungen nicht versperren. | |
|  | 8 |  Verbinden Sie nicht das Telefonkabel mit dem Signalverbindungsstecker. | |
|  | 9 |  Betriebstemperatur: Dieses Produkt wurde für den Betrieb in einer Umgebungstemperatur von nicht mehr als 40° C entworfen. | |
|  | 10 |  Alle Länder: Installation muß örtlichen und nationalen elektrischen Vorschriften entsprechen. | |















Standarder: Dette produkt tilfredsstiller de følgende standarder.

- | | | | |
|---|----------|-------------------------------------|--|
|  | 1 | Radiofrekvens forstyrrelsesemission | EN55022 Klasse A, FCC Part 15 Klasse A |
|  | 2 | Immunitet | EN55024 |
|  | 3 | Elektrisk sikkerhed | EN60950, UL60950, FCC Part 68 |
- Sikkerhed
-  **4**  Ved installation af converteren må man kun benytte den med købte PSU. AT-MC602 converteren kan installeres som enkelt node eller installeres i et AT-MCR12 chassis. Ved installation i AT-MCR12 chassis, skal man ikke benytte PSU'en.
 -  **5**  **Advarsel:** Den strømførende ledning bruges til at afbryde strømmen. Skal strømmen til apparatet afbrydes, tages ledningen ud af stikket.
 -  **6**  **Fare Under Uvejr**
Fare: UNDLAD at arbejde på udstyr eller KABLER i perioder med LYNAKTIVITET.
 -  **7**  Ventilationsåbningerne må ikke blokeres.
 -  **8**  Tilslut ikke telefonledninger til signalstikforbindelsen.
 -  **9**  **Betjeningstemperatur:** Dette apparat er konstrueret til en omgivende temperatur på maksimum 40 grader C.
 -  **10**  **Alle Lande:** Installation af produktet skal ske i overensstemmelse med lokal og national lovgivning for elektriske installationer.







Eisen: Dit product voldoet aan de volgende eisen.

 1	RFI Emissie	EN55022 Klasse A, FCC Part 15 Klasse A
 2	Immunititeit	EN55024
 3	Electrische Veiligheid	EN60950, UL60950, FCC Part 68

















Veiligheid







-  **4**  Gebruik alleen de power adapter die meegeleverd is met de verlenger. De AT-MC602 kan als stand alone gebruikt worden, maar kan ook geplaatst worden in de AT-MCR12 chassis. In het laatste geval heeft de AT-MC602 zijn powersupply niet nodig.
-  **5**  **Waarschuwing:** Het toestel wordt uitgeschakeld door de stroomkabel te ontkoppelen. Om het toestel stroomloos te maken: de stroomkabel ontkoppelen.
-  **6**  **Gevaar Voor Blikseminslag**
Gevaar: NIET aan toestellen of KABELS WERKEN bij BLIKSEM.
-  **7**  Ventilatiegaten niet blokkeren.
-  **8**  Sluit geen telefoonlijn aan op de signaalverbinding.
-  **9**  **Bedrijfstemperatuur:** De omgevingstemperatuur voor dit produkt mag niet meer bedragen dan 40 graden Celsius.
-  **10**  **Alle Landen:** het toestel installeren overeenkomstig de lokale en nationale elektrische voorschriften.

Normes: ce produit est conforme aux normes de suivantes.

- 1 Emission d'interférences radioélectriques EN55022 Class A, FCC Part 15 Class A
- 2 Immunité EN55024
- 3 Sécurité électrique EN60950, UL60950, FCC Part 68
Sécurité
- 4  Utiliser uniquement l'adaptateur aleatoire fourni avec l'extender.
Le AT-MC602 peut etre installe d'une facon autonome, ou insere dans le AT-MCR12 chassis. Dans le deuxieme cas, le AT-MC602 n'a pas besoin de l'adaptateur aleatoire.
- 5  **Attention:** Le cordon d'alimentation sert de mise hors circuit. Pour couper l'alimentation du matériel, débrancher le cordon.
- 6  **Danger De Foudre**
Danger: NE PAS MANIER le matériel ou les CÂBLES lors d'activité orageuse.
- 7  Ne pas bloquer les fentes d'aération.
- 8  Ne pas connecter une ligne téléphonique au connecteur de signaux.
- 9  **Température De Fonctionnement:** Ce matériel est capable de tolérer une température ambiante maximum de 40 degrés Celsius.
- 10  **Pour Tous Pays:** Installer le matériel conformément aux normes électriques nationales et locales.

Standardit: Tämä tuote on seuraavien standardien mukainen.















- | | | | |
|---|-----------|---|--------------------------------------|
|  | 1 | Radioaaltojen häirintä | EN55022 Class A, FCC Part 15 Class A |
|  | 2 | Kestävyys | EN55024 |
|  | 3 | Sähköturvallisuus | EN60950, UL60950, FCC Part 68 |
| | | Turvallisuus | |
|  | 4 |  Käytä vain muuntimen mukana toimitettua virtalaitetta. AT-MC602 voidaan käyttää itsenäisesti tai asennettuna AT-MCR12-kehikkoon, jälkimmäisessä tapauksessa AT-MC602 ei tarvitse erillistä virtalaitetta. | |
|  | 5 |  Huomautus: Virtajohtoa käytetään virrankatkaisulaitteena. Virta katkaistaan irrottamalla virtajohto. | |
|  | 6 |  Salamaniskuvaara
Hengenvaara: ÄLÄ TYÖSKENTELE laitteiden tai KAAPELEIDEN KANSSA SALAMOINNIN AIKANA. | |
|  | 7 |  Älä tuki ilmareikiä | |
|  | 8 |  Älä liitä puhelinlinjaa signaalin liittimeen. | |
|  | 9 |  Käyttölämpötila: Tämä tuote on suunniteltu ympäröivän ilman maksimilämpötilalle 40° C. | |
|  | 10 |  Kaikki Maat: Asenna tuote paikallisten ja kansallisten sähköturvallisuusmääräysten mukaisesti. | |







-
- Standard:** Questo prodotto è conforme ai seguenti standard.
- | | | |
|---|--|--|
| 1 | Emissione RFI (interferenza di radiofrequenza) | EN55022 Classe A, FCC Part 15 Classe A |
| 2 | Immunità | EN55024 |
| 3 | Sicurezza elettrica | EN60950, UL60950, FCC Part 68 |
- Norme Di Sicurezza
- 4  Questo dispositivo deve essere alimentato solo mediante il proprio adattatore. Il dispositivo AT-MC602 puo' essere installato a se' stante o puo' essere inserito nell' unita' AT-MCR12. In questo ultimo caso, il dispositivo AT-MC602 non richiede l' adattatore.
- 5  **Attenzione:** Il cavo di alimentazione è usato come dispositivo di disattivazione. Per togliere la corrente al dispositivo staccare il cavo di alimentazione.
- 6  **Pericolo Di Fulmini**
Pericolo: NON LAVORARE sul dispositivo o sui CAVI durante PRECIPITAZIONI TEMPORALESCE.
- 7  Non ostruire le prese d'aria.
- 8  Non collegare una linea telefonica al connettore del segnale.
- 9  **Temperatura Di Funzionamento:** Questo prodotto è concepito per una temperatura ambientale massima di 40 gradi centigradi.
- 10  **Tutti I Paesi:** installare il prodotto in conformità delle vigenti normative elettriche nazionali.

Sikkerhetsnormer: Dette produktet tilfredsstiller følgende sikkerhetsnormer.

 1	RFI stråling	EN55022 Klasse A, FCC Part 15 Klasse A
 2	Immunitet	EN55024
 3	Elektrisk sikkerhet	EN60950, UL60950, FCC Part 68

Sikkerhet















-  **4**  Ved installation av converteren må man kun benytte den med tilhørende PSU. AT-MC602 converteren kan installeres som enkel node eller installeres i et AT-MCR12 chassis. Ved installation i AT-MCR12 chassis, skal man ikke benytte PSU'en.
-  **5**  **Forsiktig:** Strømledningen brukes til å frakoble utstyret. For å deaktivere utstyret, må strømforsyningen kobles fra.
-  **6**  **Fare For Lynnedslag**
Fare: ARBEID IKKE på utstyr eller KABLER i TORDENVÆR.
-  **7**  Blokker ikke luftventilene.
-  **8**  Telefonlinje må ikke koples til signalkontakten.
-  **9**  **Driftstemperatur:** Dette produktet er konstruert for bruk i maksimum romtemperatur på 40 grader celsius.
-  **10**  **Alle Land:** Produktet må installeres i samsvar med de lokale og nasjonale elektriske koder.

-
- Padrões:** Este produto atende aos seguintes padrões.
- 1 Emissão de interferência de radiofrequência EN55022 Class A, FCC Part 15 Class A
 - 2 Imunidade EN55024
 - 3 Segurança eléctrica EN60950, UL60950, FCC Part 68
Segurança
 - 4  Use apenas adaptador de energia fornecido pelo extensão. O AT-MC602 pode ser instalado de maneira independente ou pode ser colocado dentro da unidade AT-MCR12. No último caso o AT-MC602 não precisa de adaptador de energia.
 - 5  **Cuidado:** O cabo de alimentação é utilizado como um dispositivo de desconexão. Para deseletrificar o equipamento, desconecte o cabo de ALIMENTAÇÃO.
 - 6  **Perigo De Choque Causado Por Raio**
Perigo: NÃO TRABALHE no equipamento ou nos CABOS durante períodos suscetíveis a QUEDAS DE RAIO.
 - 7  Não bloqueie as aberturas de ventilação.
 - 8  Não conecte uma linha telefônica ao conector de sinal.
 - 9  **Temperatura De Funcionamento:** Este produto foi projetado para uma temperatura ambiente máxima de 40 graus centígrados.
 - 10  **Todos Os Países:** Instale o produto de acordo com as normas nacionais e locais para instalações elétricas.







Estándares: Este producto cumple con los siguientes estándares.

- | | | |
|--|---------------------|--------------------------------------|
|  1 | Emisión RFI | EN55022 Clase A, FCC Part 15 Clase A |
|  2 | Inmunidad | EN55024 |
|  3 | Seguridad eléctrica | EN60950, UL60950, FCC Part 68 |

Seguridad

-  **4**  Use únicamente el adaptador de corriente suministrado junto con el extensor. El extensor AT-MC602 puede ser instalado en stand alone o puede ser insertado en la unidad AT-MCR12. En este ultimo caso el extensor AT-MC602 no necesita el adaptador de corriente suministrado.
-  **5**  **Atencion:** El cable de alimentacion se usa como un dispositivo de desconexion. Para desactivar el equipo, desconecte el cable de alimentación.
-  **6**  **Peligro De Rayos**
Peligro: NO REALICE NINGUN TIPO DE TRABAJO O CONEXION en los equipos o en LOS CABLES durante TORMENTAS ELECTRICAS.
-  **7**  No bloquee las aberturas para ventilacion.
-  **8**  No conectar ninguna línea telefónica al conector de señales.
-  **9**  **Temperatura Requerida Para La Operación:** Este producto está diseñado para una temperatura ambiental máxima de 40 grados C.
-  **10**  **Para Todos Los Países:** Monte el producto de acuerdo con los Códigos Eléctricos locales y nacionales.

Standarder: Denna produkt uppfyller följande standarder.

- 1 Radiostörning EN55022 Klass A, FCC Part 15 Klass A
 - 2 Immunitet EN55024
 - 3 Elsäkerhet EN60950, UL60950, FCC Part 68
- Säkerhet
- 4  Använd endast medföljande kraftaggregat till DSL konverteraren. AT-MC602 kan installeras fristående eller monterad i AT-MCR12 enheten. I det senare fallet behöver AT-MC602 inte kraftaggregatet.
 - 5  **Varning:** Nätkabeln används som strömbrytare för att koppla från strömmen, dra ur nätkabeln.
 - 6  **Fara För Blixtnedslag**
Fara: ARBETA EJ på utrustningen eller kablarna vid ÅSKVÄDER.
 - 7  Blockera inte luftventilerna.
 - 8  Koppla inte telefonledning till signalkontakten.
 - 9  **Driftstemperatur:** Denna produkt är konstruerad för rumstemperatur ej överstigande 40 grader Celsius.
 - 10  **Alla Länder:** Installera produkten i enlighet med lokala och statliga bestämmelser för elektrisk utrustning.