

SHARP

Important

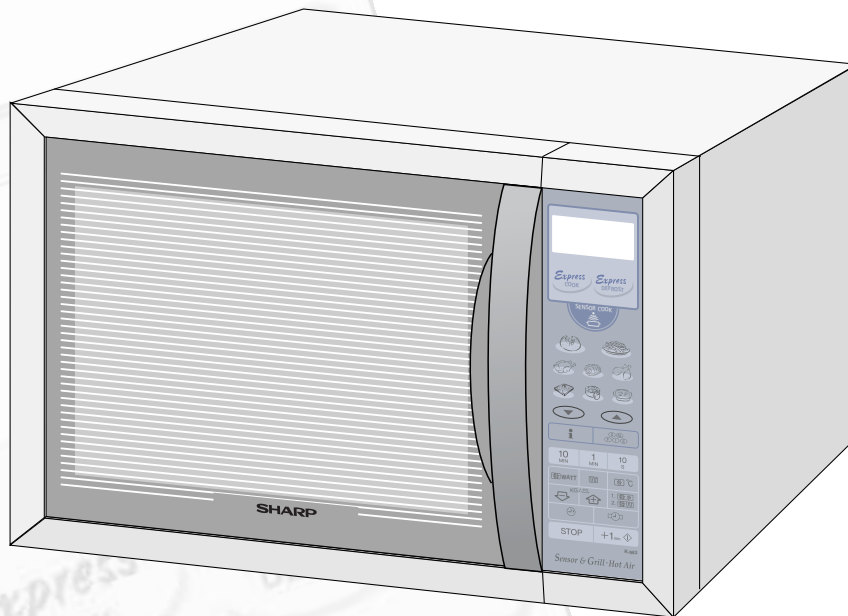

R-963S MICROWAVE OVEN WITH SENSOR, GRILL AND CONVECTION

OPERATION MANUAL

OPERATION MANUAL

This operation manual contains important information which you should read carefully before using your microwave oven.

IMPORTANT: There may be a serious risk to health if this operation manual is not followed or if the oven is modified so that it operates with the door open.

900 W (IEC 60705)

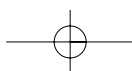
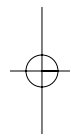
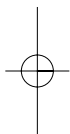
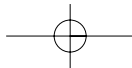

CONTENTS



OVEN AND ACCESSORIES	2
CONTROL PANEL	3
IMPORTANT SAFETY INSTRUCTIONS	4 - 6
INSTALLATION	6
BEFORE OPERATION	7
SELECTING THE LANGUAGE	7
USING THE STOP KEY	8
SETTING THE CLOCK	8
ENERGY SAVE MODE	9
MICROWAVE POWER LEVELS	9
MICROWAVE COOKING	10
GRILL COOKING	11
HEATING WITHOUT FOOD	11
CONVECTION COOKING	12 - 13
DUAL COOKING	14 - 15
OTHER CONVENIENT FUNCTIONS	16 - 19
EXPRESS COOK & EXPRESS DEFROST	20 - 21
EXPRESS COOK CHART	21
EXPRESS DEFROST CHART	22
EXPRESS DEFROST NOTES	23
SENSOR COOK	23
SENSOR COOK CHART	24
RECIPES FOR SENSOR COOK NO. 5 "FISH FILLETS WITH SAUCE"	25
RECIPES FOR SENSOR COOK NO. 6 "JAM"	26
POTATO / INSTANT ACTION	27
POTATO CHART	28
INSTANT ACTION CHART	28 - 29
RECIPES FOR INSTANT ACTION "PIQUANT CAKES"	29 - 30
RECIPES FOR USING SQUARE TIN/SHELF	31 - 32
CARE AND CLEANING	33
SERVICE CALL CHECK	34
SPECIFICATIONS	35
SERVICE ADDRESSES	36 - 41

OVEN AND ACCESSORIES

- 1 Grill heating element
- 2 Oven lamp
- 3 Control panel
- 4 Shelf runners
- 5 Waveguide cover
- 6 Oven cavity
- 7 Coupling
- 8 Door seals and sealing surfaces
- 9 Door opening handle
- 10 Air-vent openings
- 11 Outer cabinet
- 12 Power cord

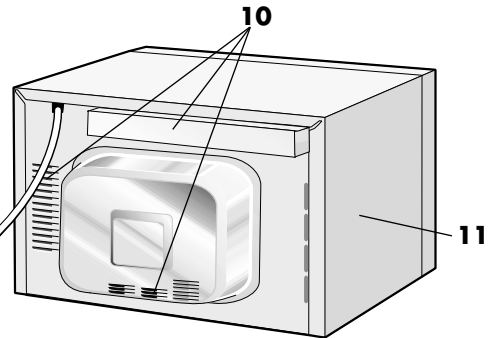
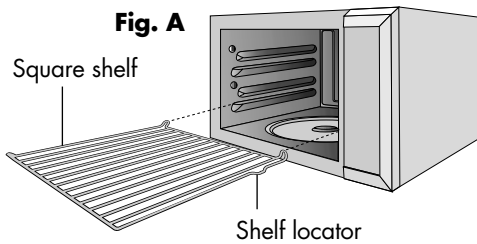
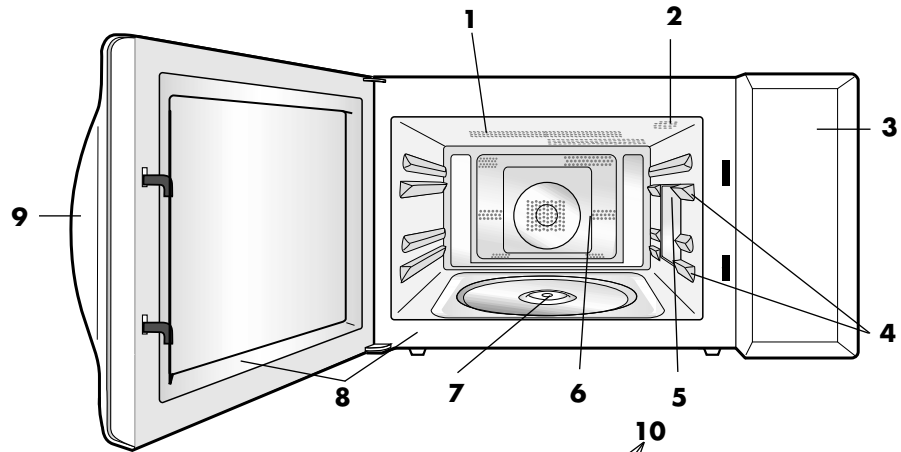

ACCESSORIES:

Check to make sure the following accessories are supplied:

- 13 Turntable 14 Turntable support 15 Low Rack
- 16 High Rack 17 Square shelf 18 Square Tin

- Place the turntable support into the coupling in the centre of the oven floor, ensuring you place it TOP side up, (TOP is engraved on one side). It should be able to freely rotate around the coupling.
- Place the turntable on to the turntable support.
- Place the high/low racks onto the turntable if necessary.
- When using the square shelf or square tin, place them onto the shelf runners as shown in Fig. A. When using the square shelf, ensure the shelf locator is on the right side.

NOTES:

- Always operate the oven with the turntable and support fitted correctly. This promotes thorough even cooking. A badly fitted turntable may rattle, may not rotate properly and damage the oven.
- The turntable rotates clockwise or counter clockwise. The rotary direction may change each time you start the oven. This does not affect cooking performance.
- When you order accessories, please mention two details: part name and model name to your dealer or SHARP authorised service facility.

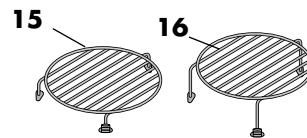
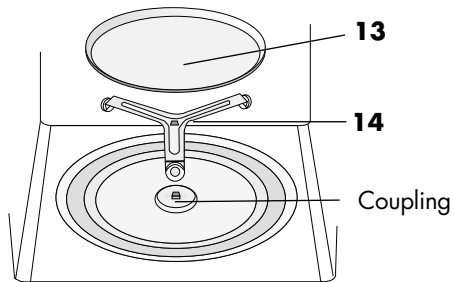

These racks are used for cooking in Convection, Dual or Grill mode.

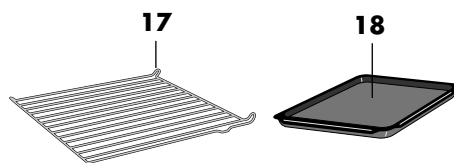

Use for convection only. See page 13.

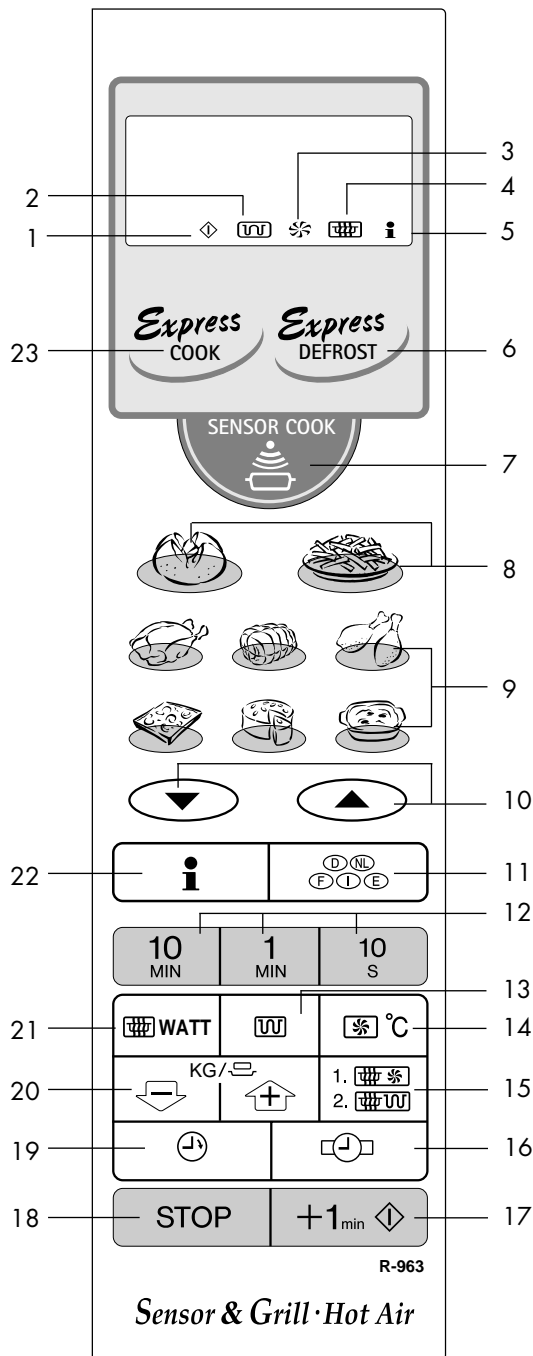

CONTROL PANEL



Digital display and indicators:

- 1 **COOKING IN PROGRESS** indicator
- 2 **GRILL** indicator
- 3 **CONVECTION** indicator
- 4 **MICROWAVE** indicator
- 5 **INFO** indicator

Operating keys:

- 6 **EXPRESS DEFROST** key
- 7 **SENSOR COOK** key
- 8 **POTATO** keys
- 9 **INSTANT ACTION** keys
- 10 **LESS/MORE** keys
- 11 **LANGUAGE** key
- 12 **TIME** keys
- 13 **GRILL** key
- 14 **CONVECTION** key
By pressing this key you can adjust the convection temperature.
- 15 **DUAL MODE** key
The are two Dual modes:
 Microwave and Convection
 Microwave and Grill
- 16 **CLOCK SETTING** key
- 17 **+ 1 min**  / **START** key
- 18 **STOP** key
- 19 **TIMER** key
- 20 **WEIGHT** keys
- 21 **MICROWAVE POWER LEVEL** key
By pressing this key you can adjust the Microwave power level.
- 22 **INFO** key
- 23 **EXPRESS COOK** key



IMPORTANT SAFETY INSTRUCTIONS

IMPORTANT SAFETY INSTRUCTIONS: READ CAREFULLY AND KEEP FOR FUTURE REFERENCE

To avoid the danger of fire

The microwave oven should not be left unattended during operation. Power levels that are too high or cooking times that are too long may overheat foods resulting in a fire.

In cases where the oven is to be installed into kitchen cabinet, the installation frame EBR-9900 (W)/(SL) licensed by SHARP must be used. This is available from your dealer. Refer to the frame installation instructions or ask your dealer for the proper instruction procedure. Only the use of this frame will guarantee the safety and quality of the product.

The electrical outlet must be readily accessible so that the unit can be unplugged easily in an emergency.

The AC power supply must be 230 V, 50 Hz, with a minimum 16 A distribution line fuse, or a minimum 16 A distribution circuit breaker.

It is recommended that a separate circuit serving only this appliance be provided.

Do not place the oven in areas where heat is generated. For example, close to a conventional oven. Do not install the oven in an area of high humidity or where moisture may collect.

Do not store or use the oven outdoors.

If food being heated begins to smoke, DO NOT OPEN THE DOOR. Turn off and unplug the oven and wait until the food has stopped smoking. Opening the door while food is smoking may cause a fire.

Use only microwave-safe containers and utensils.

Do not leave the oven unattended when using disposable plastic, paper or other combustible food containers.

Clean the waveguide cover, the oven cavity and the turntable after use. These must be dry and free from grease. Built-up grease may overheat and begin to smoke or catch fire.

Do not place flammable materials near the oven or ventilation openings. Do not block the ventilation openings.

Remove all metallic seals, wire twists, etc., from food and food packages. Arcing on metallic surfaces may cause a fire.

Do not use the microwave oven to heat oil for deep frying. The temperature cannot be controlled and the oil may catch fire.

To make popcorn, use only special microwave popcorn makers.

Do not store food or any other items inside the oven. Check the settings after you start the oven to ensure the oven is operating as desired.

See the corresponding hints in the cookery book section.

To avoid the possibility of injury

WARNING:

Do not operate the oven if it is damaged or malfunctioning. Check the following before use:

- The door; make sure the door closes properly and ensure it is not misaligned or warped.
- The hinges and safety door latches; check to make sure they are not broken or loose.
- The door seals and sealing surfaces; ensure that they have not been damaged.
- Inside the oven cavity or on the door; make sure there are no dents.
- The power supply cord and plug; ensure that they are not damaged.

Never adjust, repair or modify the oven yourself. It is hazardous for anyone other than a competent person to carry out any service or repair operation which involves the removal of a cover which gives protection against exposure to microwave energy.

Do not operate the oven with the door open or alter the door safety latches in any way.

Do not operate the oven if there is an object between the door seals and sealing surfaces.

Do not allow grease or dirt to build up on the door seals and adjacent parts. Follow instructions for "Care and Cleaning", Page 33.

Individuals with PACEMAKERS should check with their doctor or the manufacturer of the pacemaker for precautions regarding microwave ovens.

To avoid the possibility of electric shock

Under no circumstances should you remove the outer cabinet.

Never spill or insert any objects into the door lock openings or ventilation openings. In the event of a spill, turn off and unplug the oven immediately, and call an authorised SHARP service agent.

Do not immerse the power supply cord or plug in water or any other liquid.

Do not let the power supply cord hang over the edge of a table or work surface.

IMPORTANT SAFETY INSTRUCTIONS



Keep the power supply cord away from heated surfaces, including the rear of the oven.

Do not attempt to replace the oven lamp yourself or allow anyone who is not an electrician authorised by SHARP to do so. If the oven lamp fails, please consult your dealer or an authorised SHARP service agent.

If the power supply cord of this appliance is damaged, it must be replaced with a special cord. The exchange must be made by an authorised SHARP service agent.

To avoid the possibility of explosion and sudden boiling:

WARNING: Liquids and other foods must not be heated in sealed containers since they are liable to explode.

Never use sealed containers. Remove seals and lids before use. Sealed containers can explode due to a build up of pressure even after the oven has been turned off.

Take care when microwaving liquids. Use a wide-mouthed container to allow bubbles to escape.

Never heat liquids in narrow necked containers such as baby bottles, as this may result in the contents erupting from the container when heated and cause burns.

To prevent sudden eruption of boiling liquid and possible scalding:

1. Stir liquid prior to heating/reheating.
2. It is advisable to insert a glass rod or similar utensil into the liquid whilst reheating.
3. Let liquid stand in the oven at the end of cooking time to prevent delayed eruptive boiling.

Do not cook eggs in their shells, and whole hard boiled eggs should not be heated in microwave ovens since they may explode even after microwave cooking has ended. To cook or reheat eggs which have not been scrambled or mixed, pierce the yolks and the whites, or the eggs may explode. Shell and slice hard boiled eggs before reheating them in the microwave oven.

Pierce the skin of such foods as potatoes, sausages and fruit before cooking, or they may explode.

To avoid the possibility of burns

Use pot holders or oven gloves when removing food from the oven to prevent burns.

Always open containers, popcorn makers, oven cooking bags, etc., away from the face and hands to avoid steam burns.

To avoid burns, always test food temperature and stir before serving and pay special attention to the temperature of food and drink given to babies, children or the elderly.

Temperature of the container is not a true indication of the temperature of the food or drink; always check the food temperature.

Always stand back from the oven door when opening, to avoid burns from escaping steam and heat.

Slice stuffed baked foods after heating to release steam and avoid burns.

Keep children away from the door to prevent them burning themselves.

Do not touch the oven door, outer cabinet, rear cabinet, oven cavity, ventilation openings, accessories and dishes during **GRILL** mode, **CONVECTION** mode, **DUAL** mode, **EXPRESS COOK**, **POTATO** and **INSTANT ACTION** operations as they will become hot. Before cleaning make sure they are not hot.

To avoid misuse by children

WARNING: Only allow children to use the oven without supervision when adequate instructions have been given so that the child is able to use the oven in a safe way and understands the hazards of improper use.

Do not lean or swing on the oven door. Do not play with the oven or use it as a toy.

Children should be taught all important safety instructions: use of pot holders, careful removal of food coverings; paying special attention to packaging (e.g. self-heating materials) designed to make food crisp, as they may be extra hot.

Other warnings

Never modify the oven in any way.

Do not move the oven while it is in operation.

This oven is for home food preparation only and may only be used for cooking food. It is not suitable for commercial or laboratory use.

To promote trouble-free use of your oven and avoid damage.

Never operate the oven when it is empty except where recommended in the operation manual, see Page 11. Doing so may damage the oven.

When using a browning dish or self-heating material, always place a heat-resistant insulator such as a porcelain plate under it to prevent damage to the turntable due to heat stress. The preheating time specified in the dish's instructions must not be exceeded.



IMPORTANT SAFETY INSTRUCTIONS

Do not use metal utensils, which reflect microwaves and may cause electrical arcing. Do not put cans in the oven.

Use only the turntable designed for this oven.

Do not place anything on the outer cabinet during operation.

Do not use plastic containers for microwaving if the oven is still hot from using the **GRILL** mode, **CONVECTION** mode, **DUAL** mode, **EXPRESS COOK**, **POTATO** and **INSTANT ACTION** operations, because they may melt. Plastic containers must not be used during above modes unless the container manufacturer says they are suitable.

NOTE:

If you are unsure how to connect your oven, please consult an authorised, qualified electrician.

Neither the manufacturer nor the dealer can accept any liability for damage to the oven or personal injury resulting from failure to observe the correct electrical connection procedure.

Water vapour or drops may occasionally form on the oven walls or around the door seals and sealing surfaces. This is a normal occurrence and is not an indication of microwave leakage or a malfunction.



INSTALLATION

1. Remove all packing materials from the inside of the oven cavity. Discard the loose polythene sheet from between the door and cavity. Remove the feature sticker, if attached, from the outside of the door.

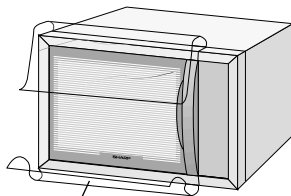

Remove this film.

2. Check the oven carefully for any signs of damage.
3. Place the oven on a flat, level surface strong enough to support the oven's weight plus the heaviest item likely to be cooked.

4. The oven door may become hot during cooking. Place or mount the oven so that the bottom of the oven is 85 cm or more above the floor. Keep children away from the door to prevent them burning themselves.

5. Ensure there is a minimum of free space above the oven of 13 cm.

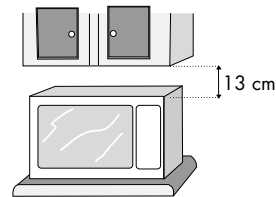

6. Securely connect the plug of the oven to a standard earthed (grounded) household electrical outlet.

BEFORE OPERATION



Your oven has an energy save mode.

1. Plug in the oven. Nothing will appear on the display at this time.

2. Open the door.

The oven display will show "SELECT LANGUAGE" in 5 languages.

NOTE: Once you select the language using the **LANGUAGE** key, the display will show "ENERGY SAVE MODE TO GO OUT OF ENERGY SAVE MODE SET CLOCK" when you plug the oven in.

3. Close the door.

4. Select a language (See below).

NOTE: If you use the oven in German, you do not have to select language, simply press the **STOP** key. The display will show ".0" and go to step 5.

5. Set the clock (See page 8).

6. Heat the oven without food (See page 11).

COOKING HINTS:

The oven has an 'Information Display System' which offers you step by step instructions to easily guide you through each feature, and enable you to gain information in your desired language. The oven has an **INFO** key for getting instructions for each key. Indicators will appear in the display, after pressing a key, to inform you of the next operation step.

SELECTING THE LANGUAGE



Press LANGUAGE key	LANGUAGE
once	DEUTSCH
twice	NEDERLANDS
3 times	FRANÇAIS
4 times	ITALIAN
5 times	ESPAÑOL

The oven comes set for German. You can change the language. To change, press the **LANGUAGE** key until the desired language is displayed. Then press the **+1 min**  /**START** key.

Example:

Suppose you want to select **Italian**:

1. Choose the desired language by pressing the **LANGUAGE** key.

2. Press the **+1 min**  /**START** key to start the setting.

Check the display.

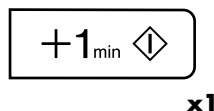
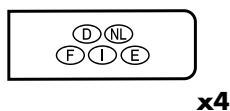

NOTE: The selected language will be memorised even if the electrical power supply is interrupted.



USING THE STOP KEY

STOP

Use the **STOP** key to:

1. Erase a mistake during programming.
2. Stop the oven temporarily during cooking.
3. Cancel a programme during cooking, press the **STOP** key twice.



SETTING THE CLOCK

There are two setting modes: 12 hour clock and 24 hour clock.

Step 1



x1

Step 2



x2

1. To set the 12 hour clock, press the **CLOCK SETTING** key once as in Step 1.
2. To set the 24 hour clock, press the **CLOCK SETTING** key twice as in Step 2.

Example:

To set the 24 hour clock to 23:35.

1. Choose the 24 hour clock by pressing the **CLOCK SETTING** key twice.
2. Input the hours. Press the **TIME** keys until the correct hour is displayed (23).
3. Change from hours to minutes by pressing the **CLOCK SETTING** key once.

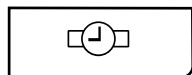

x2

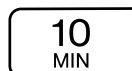

x2

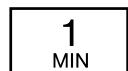

x3

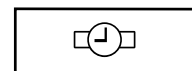

x1

4. Input the minutes (35). Press the **TIME** keys.

5. Press the **CLOCK SETTING** key to start the clock.

Check the display.

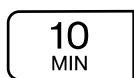

x3

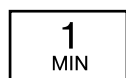

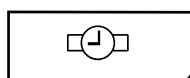

x5

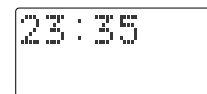

x1



NOTES:

1. Press the **STOP** key if you make a mistake during programming.
2. If the oven is in cooking or timer process and you wish to know the time of day, press the **CLOCK SETTING** key. As long as your finger is pressing the key, the time of day will be displayed.
3. If the electrical power supply to your microwave oven is interrupted, plug in the oven again, then open and close the door. The display will show "ENERGY SAVE MODE TO GO OUT OF ENERGY SAVE MODE SET CLOCK". This information will appear if you have already set the language with the **LANGUAGE** key. If this occurs during cooking, the programme will be erased. The time of day will also be erased.
4. When you want to reset the time of day, follow the above example again.
5. If you do not want to set the clock, press the **STOP** key once.  will appear on the display. When the operation of the oven is finished,  will reappear on the display instead of the time of day.
6. If you set the clock, energy save mode does not work.

ENERGY SAVE MODE



Your oven comes set for the energy save mode.

If you do nothing for 3 minutes after a preceding operation, i.e. closing the door or at the end of cooking, the power will go off automatically. To restore power on, open the door.

To start energy save mode, follow the instructions below.

Example:

To start the energy save mode, (the current time is 23:35):

1. Make sure the correct time appears on the display.
2. Press the **CLOCK SETTING** key once.
3. Press the **1 MIN** key once and make sure 0 appears on the display.
4. Press **+1 min**  **/START** key. The power will be off and the display will show nothing.

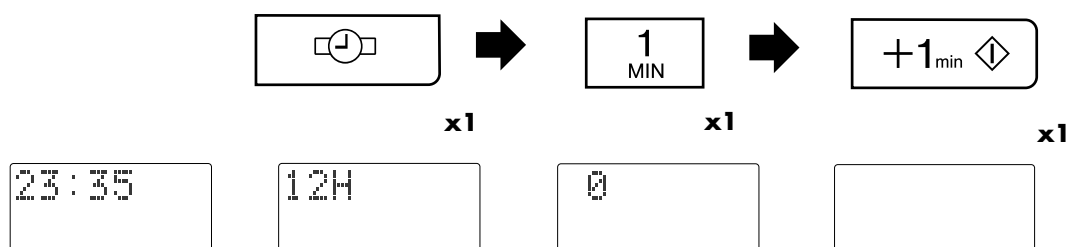

NOTE: You can press the **CLOCK SETTING** key twice at step 2.

MICROWAVE POWER LEVELS



Your oven has 5 power levels. To choose the power level for cooking, follow the advice given in the recipe section. Generally the following recommendations apply:

900 W used for fast cooking or reheating e.g. soup, casseroles, canned food, hot beverages, vegetables, fish, etc.

630 W used for longer cooking of dense foods such as roast joints, meat loaf and plated meals, also for sensitive dishes such as cheese sauce and sponge cakes. At this reduced setting, the sauce will not boil over and food will cook evenly without over cooking at the sides.

450 W for dense foods which require a long cooking time when cooked conventionally, eg. beef dishes, it is advisable to use this power setting to ensure the meat will be tender.

270 W (Defrost setting) to defrost, select this power setting, to ensure that the dish defrosts evenly. This setting is also ideal for simmering rice, pasta, dumplings and cooking egg custard.

90 W for gentle defrosting, eg. cream gateaux or pastry.

W = WATT

To set the microwave power level :

1. Input the time by pressing the **TIME** keys.
2. Press the **MICROWAVE POWER LEVEL** key until the desired power level appears on the display. (If the **MICROWAVE POWER LEVEL** key is touched once, **900 W** will be displayed. If you miss your desired level, continue pressing the **MICROWAVE POWER LEVEL** key until you reach the level again).
3. Press the **+1 min**  **/START** key.

NOTE: If the power level is not selected, 900 W is automatically set.



MICROWAVE COOKING

Your oven can be programmed for up to 99 minutes and 90 seconds (99.90).

Example:

Suppose you want to heat soup for 2 minutes and 30 seconds on 630 W microwave power.

1. Enter the cooking time by pressing the **TIME** keys.
2. Press the **MICROWAVE POWER LEVEL** key twice for 630 W microwave power.
3. Press the **+1 min**  / **START** key once to start cooking.

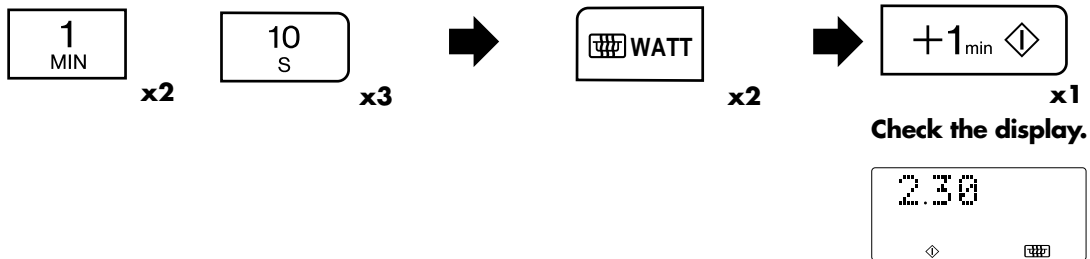

NOTES:

1. When the door is opened during the cooking process, the cooking time on the digital display stops automatically. The cooking time starts to count down again when the door is closed and the **+1 min**  / **START** key is pressed.
2. If you wish to know the power level during cooking, press the **MICROWAVE POWER LEVEL** key. As long as your finger is pressing the **MICROWAVE POWER LEVEL** key, the power level will be displayed.
3. When the operation of the oven has finished, the time of day will reappear, if set, on the display.

WARNING: Never use the square shelf and square tin for microwave cooking and dual cooking as this may cause arcing.

GRILL COOKING



The grill heating element at the top of the oven cavity has one power setting only.

Example: Suppose you want to cook cheese on toast for 5 minutes (Place toast on the high rack.)

1. Enter the cooking time by pressing the **1 MIN** key five times.
2. Select the grill mode by pressing the **GRILL** key once.
3. Press the **+1 min** / **START** key to start cooking.

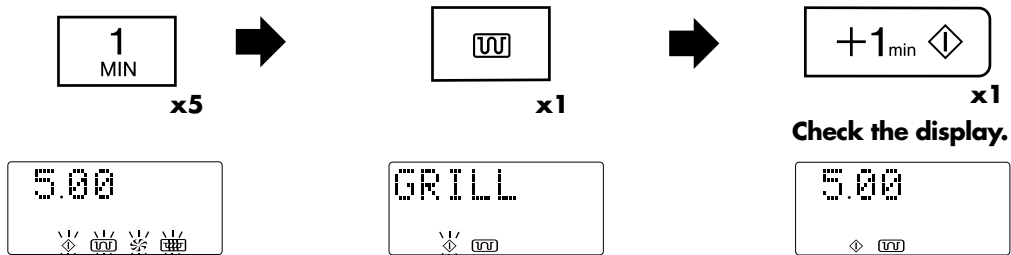

1. The high or low racks are recommended when grilling. It is not recommended to use the square shelf and square tin for grilling.
2. You may detect smoke or a burning smell when using the grill for the first time, this is normal and not a sign that the oven is out of order. (Please see heating without food below.)
3. After cooking the display may show 'NOW COOLING'.

WARNING: The oven cavity, door, outer cabinet, turntable, racks, shelves, tray and dishes will become very hot, always use thick oven gloves when removing the food or turntable from the oven to prevent burns.

HEATING WITHOUT FOOD



You may detect smoke or a burning smell when using the grill and convection for the first time. This is normal and not a sign that the oven is out of order. To avoid this problem, when first using the oven, heat the oven without food for 20 minutes on grill and then at convection 250° C.

IMPORTANT: During operation, to allow smoke or smells to disperse open a window or switch the kitchen ventilation on. Make sure there is no food in the oven.

1. Enter the required heating time. (20 min.) by pressing the **10 MIN** key twice.
2. Select **GRILL** or **CONVECTION**.
3. Start operation by pressing the **+1 min** / **START** key.

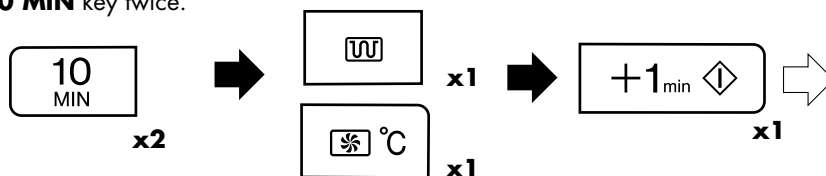

The oven will count down. When the oven has finished cooking, open the door to cool the oven cavity.

WARNING: The oven door, outer cabinet & oven cavity will become hot. Take care to avoid burns when cooling the oven down after operation.



CONVECTION COOKING

Your oven can be used as a conventional oven using the convection facility and 10 pre-set oven temperatures. Preheating is recommended for better results (especially when using the square shelf or the square tin).

Press CONVECTION key	1	2	3	4	5	6	7	8	9	10
Oven Temp (° C)	250	230	220	200	180	160	130	100	70	40

Example 1: To cook with preheating

Suppose you want to pre-heat to 200° C and cook for 20 minutes at 200° C.

1. Enter the desired preheat temperature by pressing the **CONVECTION** key four times. The display will show 200° C.

2. Press the **+1 min**  **/START** key to start pre-heating.

When the pre-heated temperature has been reached the audible signal sounds, the display will show 200° C, open the door and place the food inside the oven. Close the door.

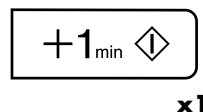
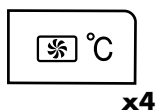

3. Enter the cooking time by pressing the **10 MIN** key twice (20 mins).

4. Press the **+1 min**  **/START** key.

Check the display.

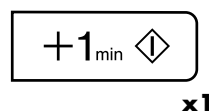

NOTES:

1. When the oven is preheated the turntable should be in the oven.
2. After preheating, if you want to cook at a different temperature press the **CONVECTION** key until the desired setting appears on the display. In the example above, to change the temperature you would press the **CONVECTION** key after entering the cooking time.
3. When the oven reaches the programmed preheating temperature, it will automatically hold at the pre-heated temperature for 30 minutes. After 30 minutes the display will change to time of day, if set. The selected convection programme will be cancelled.
4. After cooking the oven will automatically cool and the display may show "NOW COOLING".

CONVECTION COOKING



Example 2: To cook without preheating

Suppose you want to cook at 250° C for 20 minutes.

1. Enter the cooking time by pressing the **10 MIN** key twice (20 mins).
2. Select the desired cooking temperature.(250° C).
3. Press the **+1 min**  /**START** key.

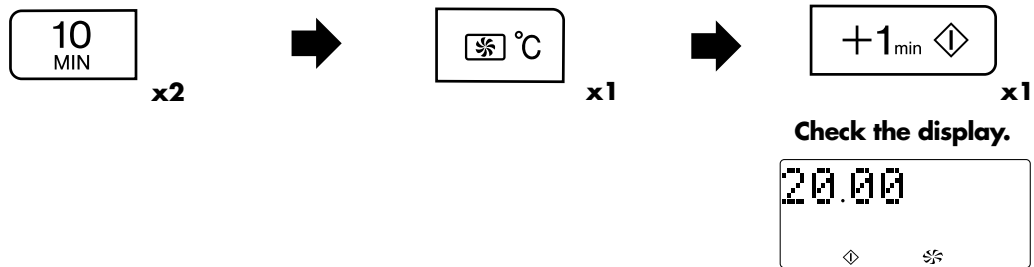

NOTES:

1. After cooking the oven will automatically cool and the display may show "NOW COOLING".
2. To change the convection temperature, press the **CONVECTION** key until the desired temperature appears on the display.
3. You may detect smoke or a burning smell when using convection for the first time. This is normal and is not a sign that the oven is out of order. (Please see Heating Without Food on page 11).

WARNING:

The oven cavity, door, outer cabinet, accessories and dishes will become very hot, use thick oven gloves when removing the food or accessories from the oven to prevent burns.

SPECIAL NOTES FOR SQUARE SHELF & SQUARE TIN:

1. When using either the square shelf or the square tin, place it at position 1. When using both of them, place the square tin at position 1 and the square shelf at position 2 as shown in the diagram.
2. When using the square shelf and/or the square tin, leave the turntable in the oven.
3. When using the square shelf or the square tin, rotate the square tin or the container on the square shelf 90° halfway to achieve better results.
4. When using the square shelf follow the notes below to prevent them slipping out:
 - Do not place container with food weighing more than 5 kg on the square shelf.
 - Ensure that the square shelf is in the correct position and does not rattle.
 - When removing the food, pull the square shelf until it is slightly locked, and then remove the food.
5. Some recipes for using the square shelf or the square tin are included in this operation manual. Please refer to pages 31 and 32.

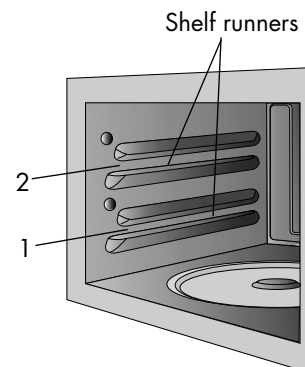







ENGLISH

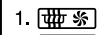

DUAL COOKING

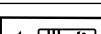
Your oven has 2 **DUAL** cooking modes combining the heat of the convection or grill with the power of the microwave.

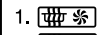
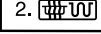
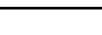
To select the **DUAL** cooking mode, choose the cooking time, then press the **DUAL MODE** key to select the desired setting. Generally, dual cooking time shortens the total cooking time.

Press DUAL MODE key	Cooking method	Microwave Power Range	Symbol
DUAL 1 1.   2.  x1	MICRO 270 W CONV 250° C	90 W - 630 W	 
DUAL 2 1.   2.  x2	MICRO 270 W GRILL	90 W - 900 W	 

NOTES:

- To adjust the microwave power, press the **MICROWAVE POWER LEVEL** key.
- To adjust the convection temperature, press the **CONVECTION** key until the desired temperature appears on the display.
- For **DUAL 1** the oven temperature can be changed from 40° C to 250° C in ten levels.

Example 1:

Suppose you want to cook for 20 minutes on DUAL 1 using 90 W microwave power and 200° C convection.

1. Enter the desired cooking time by pressing the **10 MIN** key twice (20 minutes).
2. Select the cooking mode by pressing the **DUAL MODE** key once.
3. Press the **MICROWAVE POWER LEVEL** key once (90 W).

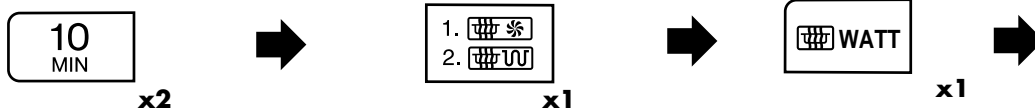

4. Press **CONVECTION** key three times (200° C).
 5. Press the **+1 min**  **/START** key.
- Check the display.**

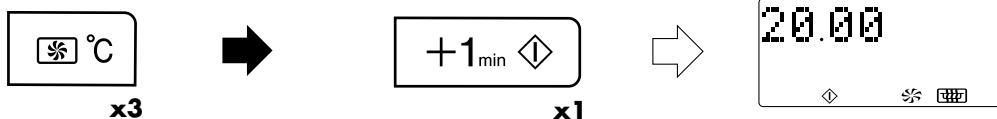

DUAL COOKING



Example 2:

Suppose you want to cook for 20 minutes on DUAL 2 using 90 W microwave power and GRILL.

1. Enter the desired cooking time by pressing the **10 MIN** key twice (20 min).

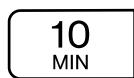

x2



2. Select the cooking mode by pressing the **DUAL MODE** key twice.

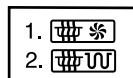

x2



3. Press the **MICROWAVE POWER LEVEL** key once (90 W).



x1



4. Press the **+1 min**  /**START** key.

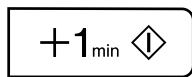

x1



Check the display.



NOTE: After cooking, the oven will automatically cool and the display may show "NOW COOLING".

WARNINGS:

1. The oven cavity, door, outer cabinet, turntable, racks and dishes will become very hot, use thick oven gloves when removing the food or turntable from the oven to prevent burns.
2. Never use the square shelf and square tin for microwave cooking and dual cooking as this may cause arcing.



OTHER CONVENIENT FUNCTIONS

1. MULTIPLE SEQUENCE COOKING

A maximum of 4 sequences can be input, consisting of manual cooking time and mode.

Example:

To cook: 5 minutes on 900 W power (Stage 1)
16 minutes on 270 W power (Stage 2)

STAGE 1

1. Enter the desired cooking time by pressing the **1 MIN** key 5 times.
2. Choose the desired power level by pressing the **MICROWAVE POWER LEVEL** key once.

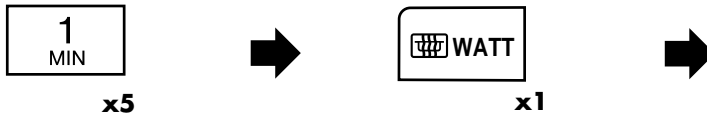

STAGE 2

3. Enter the desired cooking time by pressing the **10 MIN** key once and the **1 MIN** key 6 times.
4. Choose the desired power level by pressing the **MICROWAVE POWER LEVEL** key four times.
5. Press the **+1 min** / **START** key once to begin cooking.



Check the display



(The oven will begin to cook for 5 minutes on 900 W, and then for 16 minutes on 270 W).

OTHER CONVENIENT FUNCTIONS



2. LESS (▼) / MORE (▲) key

The **LESS (▼)** and **MORE (▲)** keys allow you to decrease or increase programmed setting times easily, (for a less well or more well cooked result), used for automatic operation or when cooking is underway.

a) 1. Changing the pre-programmed time setting for EXPRESS COOK/EXPRESS DEFROST:

Press the **LESS (▼)** and **MORE (▲)** key after entering weight and before pressing the **+1 min** / **START** key.

Example: Suppose you want to cook 0,2 kg Frozen Gratin using the **EXPRESS COOK** and **MORE (▲)** key.

1. Choose the **EXPRESS COOK** menu for Frozen Gratin by pressing the **EXPRESS COOK** key 3 times.
2. Press the **WEIGHT** keys until the correct weight appears in the display (0,2 kg).
3. Choose the desired result (well cooked) by pressing the **MORE (▲)** key once.

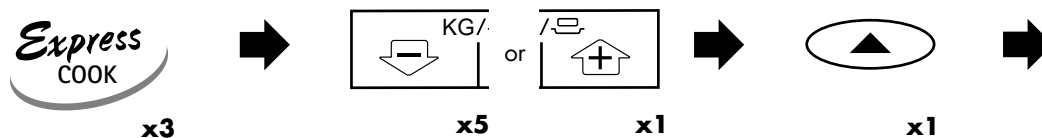

4. Press the **+1 min** / **START** key once to begin cooking.

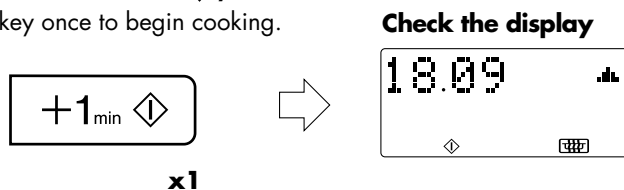

a) 2. Changing the pre-programmed time setting for SENSOR COOK/POTATO/INSTANT ACTION:

Press the **LESS (▼)** and **MORE (▲)** key just after selecting the menu (within two seconds).

Example: Suppose you want to cook 0,2 kg Thin French Fried Potatoes using the **POTATO** and **LESS (▼)** key.

1. Choose the **POTATO** menu and quantity by pressing the **FRENCH FRIED POTATO** key once.
2. Choose the desired result (less cooked for thin type) by pressing the **LESS (▼)** key once within 2 seconds.

The oven starts automatically.

Check the display.

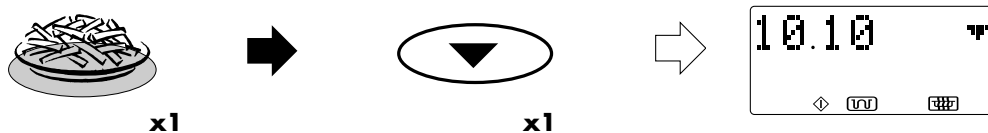

NOTES:

To cancel **LESS** or **MORE** press the same key again.

To change **MORE** to **LESS** simply press the **LESS (▼)** key.

To change **LESS** to **MORE** simply press the **MORE (▲)** key.

b) Changing the heating time while the oven is operating:

The cooking time can be decreased or increased in 1 minute steps each time the **LESS (▼)** and **MORE (▲)** keys are pressed.



OTHER CONVENIENT FUNCTIONS

3. MINUTE PLUS FUNCTION

The **+1 min**  /**START** key allows you to operate the two following functions:

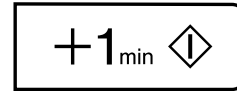

a) Direct start

You can directly start cooking on 900 W microwave power for 1 minute by pressing the **+1 min**  /**START** key.

NOTE:

To avoid the misuse by children the **+1 min**  /**START** key can be used only within 3 minutes after preceding operation, i.e., closing the door, pressing the **STOP** key or cooking completion.

b) Extend the cooking time

You can extend the cooking time for multiples of 1 minute if the **+1 min**  /**START** key is pressed while the oven is in operation.

4. TO CHECK SETTINGS WHILE THE OVEN IS OPERATING

You can check the power level and the actual oven temperatures while the oven is in operation ie: when pre-heating.

TO CHECK THE POWER LEVEL:

To check the microwave power level during cooking press the **MICROWAVE POWER LEVEL** key. The oven continues to count down, although the display shows the power level.

As long as your finger is pressing the key, the power level will be displayed.



TO CHECK THE CONVECTION TEMPERATURE:

To check the convection temperature during cooking press the **CONVECTION** key. When the oven is pre-heating, you can check the actual oven temperature.

As long as your finger is pressing the key, the convection temperature in °C will be displayed.



OTHER CONVENIENT FUNCTIONS



5. INFO key

Each button carries useful information. If you wish to get the information, press the **INFO** key before pressing the desired key.

Example:

Suppose you want to get information about INSTANT ACTION, Roast chicken:

NOTE:

1. The information message will be repeated twice, and then the display will show the time of day, if set.
2. If you want to cancel the information press the **STOP** key.



x1



x1

1. Choose the **INFO** key function.

2. Press the **INSTANT ACTION** key for Roast Chicken.

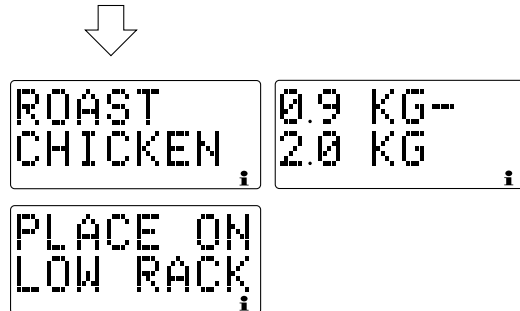

6. TIMER FUNCTION

You can use the timer for timing where microwave cooking is not involved for example, to time boiled eggs cooked on a conventional hob.

Example:

To set the timer for 5 minutes.

1. Press the **TIMER** key once.
 2. Press the **1 MIN** key five times.
 3. Press the **+1 min** / **START** key to start the timer.
- Check the display**

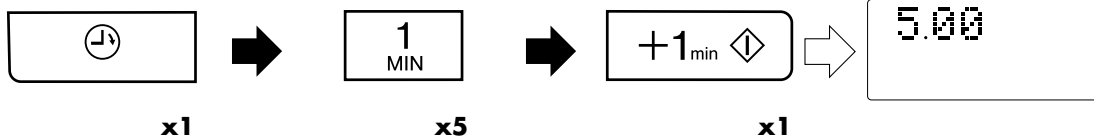



EXPRESS COOK & EXPRESS DEFROST

The **EXPRESS COOK** and **EXPRESS DEFROST** functions automatically work out the correct cooking mode and cooking time. You can choose from 3 **EXPRESS COOK** menus and 7 **EXPRESS DEFROST** menus.

Warning:

For EXPRESS COOK:

The oven cavity, door, outer cabinet, turntable, shelves, tin, racks and dishes will become very hot. Use thick oven gloves when removing food or the turntable from the oven to prevent burns.

What you need to know when using **EXPRESS COOK** and **EXPRESS DEFROST**:

1. Enter the menu by pressing the **EXPRESS COOK** or **EXPRESS DEFROST** key until the desired menu number appears in the display. (See pages 21-22)
2. The weight or quantity of the food can be input by pressing the **WEIGHT** keys until the desired weight/quantity is displayed.
 - Enter the weight of the food only. Do not include the weight of the container.
 - For food weighing more or less than weights/quantities given in the cooking charts, cook manually.
3. The programmed cooking times are average times. If you want to alter cooking times pre-programmed in the automatic operations, use the **LESS** (▼) or **MORE** (▲) key. See Page 17 for details. For best results, follow cooking chart instructions.
4. To start cooking press **+1 min** / **START** key.

When action is required (e.g. to turn food over) the oven stops and the audible signals sound, the display shows the necessary action. To continue cooking, press the **+1 min** / **START** key.

The final temperature will vary according to the initial temperature. Check food is piping hot after cooking. If necessary, you can extend the cooking time and change the power level.

NOTE: Please refer to the menu label for list of **EXPRESS COOK** and **EXPRESS DEFROST** menus and weight ranges.



1.

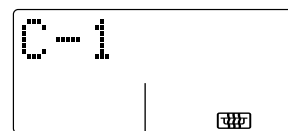

Menu Number

2.

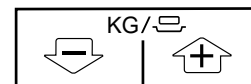

WEIGHT keys

3.



LESS/MORE keys

4.

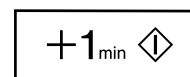

+1 min / START key

EXPRESS COOK & EXPRESS DEFROST



Example: Suppose you want to cook 0,2 kg of Frozen Gratin using EXPRESS COOK.

1. Press the **EXPRESS COOK** key 3 times to select Frozen Gratin.
2. Enter the weight by pressing the **WEIGHT** keys until the desired weight is displayed.
3. Press the **+1 min** /**START** key to start cooking.

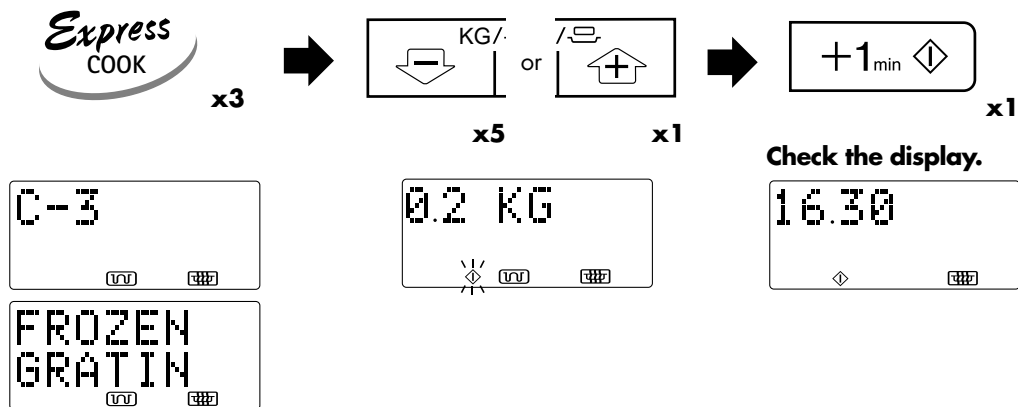

EXPRESS COOK CHART



MENU NO.	WEIGHT (Increasing Unit) / UTENSILS	PROCEDURE
C-1 Cook Frozen Ready Meals (initial temp -18° C) Stirrable type (e.g. Noodles Bolognese, Chinese Menus.)	0,3 - 1,0 kg* (100 g) Casserole dish & lid * If the manufacturer instructs to add water, please calculate the total amount for the program with additional liquid.	<ul style="list-style-type: none"> • Transfer meal to suitable casserole dish. • Add some liquid if recommended by the manufacturer. • Cover with a lid. • When the audible signals sound, stir and re-cover. • After cooking, stir and let stand for approx. 1-2 minutes.
C-2 Cook Frozen Vegetables (initial temp -18° C) e.g. Brussel sprouts, cauliflower, peas, mixed vegetables, broccoli	0,1 - 0,8 kg (100 g) Casserole dish & lid	<ul style="list-style-type: none"> • Add 1tbsp water per 100 g. (For mushrooms no additional water is necessary). • Cover with a lid. • When the oven stops and the audible signals sound, stir and re-cover. • After cooking, let stand for approx. 1-2 minutes. <p>NOTE: If frozen vegetables are compacted together, cook manually.</p>
C-3 Cook Frozen Gratin (initial temp -18° C) e.g. Frozen lasagne, Potato gratin	0,2 - 0,6 kg (100 g) Gratin dish Low rack	<ul style="list-style-type: none"> • Remove the gratin from original container and place in a suitable gratin dish. • Add 3-4 tbsp water if necessary. • Do not cover. • Place on the low rack. • After cooking, let stand, covered in aluminium foil for approximately 5 minutes.



EXPRESS DEFROST CHART

MENU NO.	WEIGHT (Increasing Unit) / UTENSILS	PROCEDURE
D-1 Defrost * Steaks, Chops (initial temp -18° C)	0,2 - 1,0 kg (100 g) (see note on page 23)	<ul style="list-style-type: none"> Place the food on a plate in the centre of the turntable. When the oven stops and the audible signals sound, turn the food over, rearrange and separate. Shield the thin parts and warm spots with aluminium foil. After defrosting, wrap in aluminium foil for 10-15 minutes, until thoroughly defrosted.
D-2 Defrost * Meat Joint (initial temp -18° C)	0,6 - 2,0 kg (100 g) (see note on page 23)	<ul style="list-style-type: none"> Place a plate upside down on the turntable and put the meat on it. When the oven stops and the audible signals sound, turn the food over. Shield the defrosted parts with aluminium foil. If audible signals sound, turn the food over and shield again (for 1,1 kg - 2,0 kg). After defrosting, cover with aluminium foil and stand for 15-30 minutes until thoroughly defrosted.
D-3 Defrost * Minced Meat (initial temp -18° C)	0,2 - 1,0 kg (100 g) Cling film (see note on page 23)	<ul style="list-style-type: none"> Cover the turntable with cling film. Place the block of minced meat onto the turntable. When the oven stops and the audible signals sound, turn the food over. Remove the defrosted parts if possible. After defrosting, cover in aluminium foil for 5-10 minutes, until thoroughly defrosted.
D-4 Defrost * Chicken Legs (initial temp -18° C)	0,2 - 1,0 kg (50 g) (see note on page 23)	<ul style="list-style-type: none"> Place the food on a plate in the centre of the turntable. When the oven stops and the audible signals sound, turn the food over, rearrange and separate. Shield the thin parts and warm spots with aluminium foil. After defrosting, wrap in aluminium foil for 10-15 minutes, until thoroughly defrosted.
D-5 Defrost * Poultry (initial temp -18° C)	0,9 - 2,0 kg (100 g) (see note on page 23)	<ul style="list-style-type: none"> Place a plate upside down on the turntable and put the poultry breast side down on the plate. When the oven stops and the audible signals sound, turnover and shield the thin parts and warm spots with aluminium foil. After defrosting, cover with aluminium foil and stand for 15-30 minutes until thoroughly defrosted. Finally clean the poultry under running water.
D-6 Defrost * Cake (initial temp -18° C)	0,1 - 1,4 kg (100 g) Flat dish	<ul style="list-style-type: none"> Remove all packaging from the cake. Place on a flat dish in the centre of the turntable. After defrosting, cut the cake into similar sized pieces. Keep space between each piece and let stand for 15-30 minutes until thoroughly defrosted.
D-7 Defrost * Bread (initial temp -18° C)	0,1 - 1,0 kg (100 g) Flat dish	<ul style="list-style-type: none"> Distribute on a flat dish in the centre of the turntable. Only sliced bread is recommended for this programme. When the audible signals sound rearrange, and remove defrosted slices. After defrosting separate all slices and distribute on a large plate. Cover the bread with aluminium foil and let stand for 5-10 minutes until thoroughly defrosted.

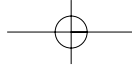

EXPRESS DEFROST NOTES



NOTES:

- 1 Steaks, Chops and Chicken legs should be frozen in one layer.
- 2 Minced meat should be frozen in the thin shape.
- 3 After turning over, shield the defrosted portions with small, flat pieces of aluminium foil.
- 4 The poultry and the minced meat should be processed immediately after defrosting.
- 5 For D-1, D-2, D-4 and D-5 arrange the food in the oven as shown:

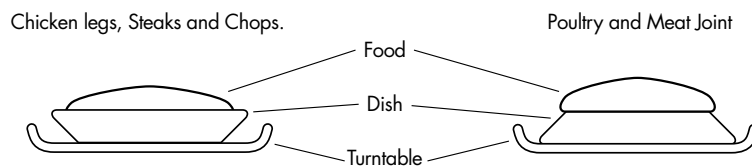

SENSOR COOK



Your oven has a humidity sensor. The humidity sensor detects the vapour from the food and calculates the correct microwave power level and cooking time.

The **SENSOR COOK** key offers the possibility to easily cook 6 menus without entering the food quantity.

To select the sensor cook menu, touch the **SENSOR COOK** key until the desired menu is displayed.

The **SENSOR COOK** can only be input within 3 minutes after cooking completion, closing the door or pressing the **STOP** key.

Always refer to the **SENSOR COOK** chart on page 24 before operating this function.

NOTES:

1. After the oven is plugged in, wait 2 minutes before using **SENSOR COOK**.
2. Once a **SENSOR COOK** programme has started, do not open the door or press the **STOP** key until the remaining cooking time appears on the display, unless following instructions to stir or turn over. During this time, Sensor technology senses humidity emitted from food as it heats and determines the cooking time. Opening the door or stopping the oven disturbs the humidity content and affects the cooking result.
3. Ensure food is thoroughly heated before serving. If additional heating is required, cook this manually.
4. Wipe off any moisture from the outside of cooking containers and the interior of the oven with a dry cloth or paper towel prior to cooking on **SENSOR COOK**.
5. If you want to alter the cooking results, press the **LESS (▼)** or **MORE (▲)** keys after selecting the menu (See page 17 for details). For best results use the cooking chart instructions.
6. If food requires manipulation (i.e. turn over or stir) then open the door, follow the instruction, close the door and press the **+1 min** /**START** key.
7. To cook the food weighing more or less than the weights/quantities given in the cooking charts, cook using manual programmes.

EXAMPLE: Suppose you want to cook 300 g of fresh vegetables

1. Press the **SENSOR COOK** key twice to select Fresh Vegetables.



After 2 seconds the oven starts automatically. When the sensor detects the vapour from the food, the remaining cooking time will appear.

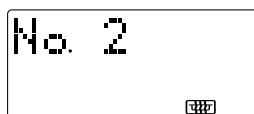



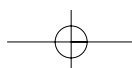



NOTE: Please refer to the menu label for list of **SENSOR COOK** menus and weight ranges.





SENSOR COOK CHART

MENU	WEIGHT (Increasing Unit) / UTENSILS	PROCEDURE								
No. 1 Casserole (initial temp 5-20° C) 	200 - 1000 ml Cup or bowl (for more than 200 ml) & microwave plastic wrap	<ul style="list-style-type: none"> Place the bowl in the centre of the turntable. Cover with microwave plastic wrap. After cooking, stir and let stand covered for approx. 2 mins. NOTE: If you do not use plastic wrap with holes, pierce the wrap 5 times (for bowl) or twice (for cup) with a fork.								
No. 2 Fresh vegetables (initial temp 20° C) e.g. Cauliflower, carrot, broccoli, fennel, leek, pepper, courgettes etc. 	0,1 - 0,8 kg Bowl & lid	<ul style="list-style-type: none"> Cut into small pieces, e.g. strips, cubes or slices. Add the required amount of water (1 tbsp per 100 g). Cover with a lid. After cooking, stir and let the food stand for approx. 2 mins. 								
No. 3 Rice (par-boiled) (initial temp rice 20° C) 	0,1 - 0,3 kg Big bowl & lid	<ul style="list-style-type: none"> Place in a big bowl and add boiling water. Cover with a lid. When the oven stops and the audible signals sound, stir. When the oven stops and the audible signals sound, stir again. After cooking, let stand, covered for approx. 10 mins. 								
	<table border="1"> <thead> <tr> <th>Rice</th> <th>Boiling Water</th> </tr> </thead> <tbody> <tr> <td>100 g</td> <td>250 ml</td> </tr> <tr> <td>200 g</td> <td>450 ml</td> </tr> <tr> <td>300 g</td> <td>650 ml</td> </tr> </tbody> </table>	Rice	Boiling Water	100 g	250 ml	200 g	450 ml	300 g	650 ml	
Rice	Boiling Water									
100 g	250 ml									
200 g	450 ml									
300 g	650 ml									
No. 4 Pasta (initial temp pasta 20° C) 	0,1 - 0,3 kg Big bowl & lid	<ul style="list-style-type: none"> Place in a big bowl and add boiling water. Cover with a lid. When the oven stops and the audible signals sound, stir. When the oven stops and the audible signals sound, stir again. After cooking, let stand, covered for approx. 2-3 mins. 								
	<table border="1"> <thead> <tr> <th>Pasta</th> <th>Boiling Water</th> </tr> </thead> <tbody> <tr> <td>100 g</td> <td>250 ml</td> </tr> <tr> <td>200 g</td> <td>550 ml</td> </tr> <tr> <td>300 g</td> <td>800 ml</td> </tr> </tbody> </table>	Pasta	Boiling Water	100 g	250 ml	200 g	550 ml	300 g	800 ml	
Pasta	Boiling Water									
100 g	250 ml									
200 g	550 ml									
300 g	800 ml									
No. 5 Fish fillets with sauce (initial temp Fish 5° C Sauce 20° C) 	0,4-1,6 kg* fish: 0,2 - 0,8 kg sauce: 0,2 - 0,8 kg Quiche dish and microwave plastic wrap * Total weight of fish and sauce	<ul style="list-style-type: none"> Put the fish fillets in a quiche dish with the thin ends towards the centre. Spread prepared sauce on fish fillet. Cover with microwave plastic wrap. After cooking let stand, covered for approx. 2 minutes. For sauce recipes, see page 25.								
No. 6 Jam (initial temp 20° C) 	0,5 - 1,5 kg* 3,5 l casserole dish * Total weight of fruit and jelly sugar	<ul style="list-style-type: none"> Follow quantity in recipes on page 26. Defrost frozen fruits before cooking. No cover. When the oven stops and the audible signals sound, stir. When the oven stops and the audible signals sound again, mash. After cooking, fill into well cleaned glasses and cover with a twist-off-lid or with preserving film. NOTE: Use a big casserole dish to prevent the food from spilling over.								

RECIPES FOR SENSOR COOK No. 5 "FISH FILLETS WITH SAUCE"



Fish fillet with sauce - Cod fish fillet Provençal

Ingredients

20 g	butter
100 g	mushrooms cut in slices
1 clove	garlic (crushed)
50 g	spring onion
1 tin (825 g)	finned tomatoes without juice, drain well
1 tsp	lemon juice
2 tbsps	tomato ketchup
1/2-1 tsp	dried basil, salt and pepper
800 g	cod fish fillet

Preparation

1. Cook butter, mushrooms, onions and garlic together in a flan dish for 3-4 mins. on 900 W.
2. Mix tomatoes, lemon juice, ketchup, basil, salt and pepper.
3. Place fish fillet on the vegetables and cover with sauce and some vegetables. Cover with microwave plastic wrap.
4. Cook on **SENSOR COOK No. 5** "Fish fillets with sauce".

Fishfillet with Leek and Cheese-sauce

Ingredients

50 g	butter
175 g	spring onion
1/2 tsp	dried Marjoram
40 g	flour
500 ml	milk
100 g	grated Gruyere, salt, pepper
1 tbsps	chopped parsley
800 g	fish fillet (e.g. coal fish)

Preparation

1. Put butter, onions and Marjoram in a casserole and heat for 3-4 mins on 900 W.
2. Stir in the flour and add the milk. Stir to a smooth sauce.
3. Cook for 3-4 mins on 900 W uncovered.
4. Stir in the cheese, season to taste.
5. Place the fish fillet in a quiche dish and pour the sauce over it. Cover with microwave plastic wrap.
6. Cook on **SENSOR COOK No. 5** "Fish fillets with sauce".
7. After cooking take out the fish and stir the sauce well.

NOTES:

1. These indications are for 1.6 kg. If you want to cook less than 1.6 kg you have to adjust (reduce) the ingredients for the sauce and also the cooking time for the preparation of the sauce.
2. If you want to make the sauce thicker for cod fillet provençal or fish fillet with piquant sauce, remove the fish after cooking and stir in some sauce thickening powder (please follow manufacturer's instructions).

Fish fillet with Piquant sauce

Ingredients

1 tin (825 g)	canned tomatoes, drain
1 tin (280 g)	corn
2-3 tsp	chilli sauce
40 g	onion, finely chopped
3 tsp	red wine vinegar
1/4 tsp	mustard
1 spice	thyme
1 spice	cayenne pepper
800 g	fish fillet (e.g. rosefish)

Preparation

1. Mix ingredients for the sauce.
2. Place fish fillet (e.g. Rosefish fillet) in a quiche dish and spread the sauce on fish fillet. Cover with microwave plastic wrap.
3. Cook on **SENSOR COOK No. 5** "Fish fillets with sauce".

Fishfillet with Curry sauce

Ingredients

40 g	butter
30 g	chopped almonds
1-2 tbsps	curry powder
30 g	flour (wholemeal)
40 g	raisins
200 g	pineapple (small pieces)
125 ml	broth
125 ml	pineapple juice
150 g	sour cream
100 g	peas (frozen), salt, pepper
800 g	fish fillet (coal fish)

Preparation

1. Heat butter, almonds and curry covered for 1-2 mins on 900 W.
2. Add the flour and stir very well.
3. Add raisins, pineapple, pineapple juice, broth and cream, stirring continuously.
4. Cook covered for 2-3 mins. on 900 W and stir after cooking.
5. Add the peas and stir.
6. Season with salt and pepper.
7. Place the fish in a quiche dish and pour over the sauce. Cover with microwave plastic wrap.
8. Cook on **SENSOR COOK No. 5** "Fish fillets with sauce".



RECIPES FOR SENSOR COOK No. 6 "JAM"

Kiwi - Banana Jam

Ingredients

- 525 g Kiwi
- 225 g Banana
- 250 g Jelly sugar
(preserving sugar with pectin,
1 sugar : 3 fruits)

Preparation

1. Peel kiwis and bananas and cut into small pieces.
2. Mix the fruits with preserving sugar with pectin and fill into an oval 3,5 l-glass form (pyrex).
3. Cook on **SENSOR COOK No. 6** "Jam".
4. After cooking fill into well cleaned glasses and cover with twist-off-lid or with preserving film.

Nectarine Jam

Ingredients

- 667 g Nectarines
- 3 tbsp. Lemon juice
- 333 g Jelly sugar
(preserving sugar with pectin,
1 sugar : 2 fruits)
- 4 tbsp. Orange liqueur (for ex. Coitreau)

Preparation

1. Cut nectarines into small pieces.
2. Put them into an oval 3,5 l-glassform (pyrex).
3. Mix them with lemon juice and preserving sugar with pectin.
4. Cook on **SENSOR COOK No. 6** "Jam".
5. After cooking add orange liqueur, fill into well cleaned glasses and cover with twist-off-lid or with preserving film.

Raspberry Jam

Ingredients

- 750 g Raspberries
- 250 g Jelly sugar
(preserving sugar with pectin,
1 sugar : 3 fruits)

Preparation

1. Mix raspberries with preserving sugar with pectin and fill into an 3,5 l-glassform (pyrex).
2. Cook on **SENSOR COOK No. 6** "Jam".
3. After cooking fill into well cleaned glasses and cover with twist-off-lid or with preserving film.

Mixed Berries Jam

Ingredients

- 667 g Mixed berries (blackberry, blueberry, raspberry, currant, strawberry)
- 333 g Jelly sugar
(preserving sugar with pectin,
1 sugar : 2 fruits)

Preparation

1. Fill mixed berries and preserving sugar with pectin into an oval 3,5 l-glassform (pyrex) and mix them.
2. Cook on **SENSOR COOK No. 6** "Jam".
3. After cooking fill into well cleaned glasses and cover with twist-off-lid or with preserving film.

NOTE:



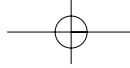





1. Please follow the instructions in the SENSOR COOK chart on page 24.
2. These instructions are for 1,0 kg. If you want to cook other weights, adjust the ingredients.



POTATO/INSTANT ACTION



The **POTATO/INSTANT ACTION** functions automatically work out the correct cooking mode and cooking time of the foods illustrated below.

POTATO keys		POTATO keys	
1		2	
<p>INSTANT ACTION keys</p>			
3		4	
5		6	
7		8	

What you need to know when using **POTATO/INSTANT ACTION** :

1. Input the menu by pressing the desired key. The **POTATO/INSTANT ACTION** can only be input within 3 minutes after cooking completion, closing the door or pressing the **STOP** key.
2. To increase the weight press the selected key until the desired weight is displayed. Enter the weight of the food only. Do not include the weight of the container.
For food weighing more or less than the weights/quantities given in the cooking charts, cook using manual operation.
3. The programmed cooking times are average times. If you want to alter the cooking times of **POTATO/INSTANT ACTION**, use the **LESS (▼)** or **MORE (▲)** keys after selecting the menu and weight (see page 17 for details). For best results use the cooking chart instructions.
4. The oven will start to cook instantly after the weight has been input.

Warning:

The oven cavity, door, outer cabinet, accessories and dishes will become very hot. Use thick oven gloves when removing food or the accessories from the oven to prevent burns.

NOTES:

When manipulation is required (eg: to turn food over) the oven will stop and the audible signal will sound, the display will show the necessary action. To continue cooking, press the **+1 min**  /**START** key. The final temperature of the food will vary according to its initial temperature. Check food is piping hot after cooking. If necessary, you can extend the cooking time. Always refer to the cooking charts given in the separate cookery book.

Example: Suppose you want to cook 200 g of French Fried Potatoes (Thick type).

Choose the menu and quantity by pressing the **FRENCH FRIED POTATO** key once.



The oven will instantly begin to cook.



NOTE: Please refer to the menu label for list of **POTATO/INSTANT ACTION** menus and weight ranges.

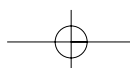



POTATO CHART

MENU	WEIGHT (Increasing Unit) / UTENSILS	PROCEDURE
Boiled/Jacket Potatoes (initial temp 20° C)	0,1 - 0,8 kg (100 g) Bowl & lid	<ul style="list-style-type: none"> Peel the potatoes and cut them into similar sized pieces, if necessary. Put them in a bowl. Add the required amount of water (2 tbsp. per 100 g) and add a little salt. Cover with lid. When the audible signals sound, stir and recover. After cooking, let stand for 1-2 minutes.
French Fried Potatoes (recommended for conventional ovens) (initial temp -18° C)	0,2 - 0,4 kg (50 g) Flat round gratin dish or Flan dish & high rack	<ul style="list-style-type: none"> Place the french fried potatoes in a flan dish on the high rack. When the audible signals sound, turn over. After cooking, remove from the flan dish and serve on a plate. Season with salt as desired. <p>NOTE: Use the LESS (▼) key for cooking thin french fried potatoes.</p>





INSTANT ACTION CHART

MENU	WEIGHT (Increasing Unit) / UTENSILS	PROCEDURE
Roast Chicken (initial temp 5° C)	0,9 - 2,0 kg (100 g) Low rack	<ul style="list-style-type: none"> Mix the ingredients and spread on chicken. Pierce the skin of the chicken. Put the chicken breast side down on the low rack. When the audible signals sound, turn the chicken over. After cooking, let stand for approx. 3 minutes.
Roast Pork (initial temp 5° C)	0,6 - 2,0 kg (100 g) Low rack	<ul style="list-style-type: none"> Using lean roast pork is recommended. Mix all ingredients and spread them on the pork. Place the pork on the low rack. When the audible signals sound, turn the food over. After cooking, let stand, wrapped in aluminium foil for approx. 10 minutes.
Chicken legs (initial temp 5° C)	0,2 - 1,0 kg (0,2 - 0,3 kg: 50 g 0,3 - 1,0 kg: 100 g) High rack	<ul style="list-style-type: none"> Mix the ingredients and spread on chicken legs. Pierce the skin of the chicken legs. Put the chicken legs on the high rack with the thin ends towards the centre. When the audible signals sound, turn the food over. After cooking, let stand for approx. 3 minutes.

INSTANT ACTION CHART



MENU	WEIGHT (Increasing Unit) / UTENSILS	PROCEDURE
Piquant Cakes  (initial temp 20° C) e.g. Onion gateau Leek tart, Pizza	1,0 - 1,6 kg (100 g) Square tin NOTE: The tin gets very hot during cooking. To avoid burning yourself, use oven gloves when removing it from the oven.	<ul style="list-style-type: none"> • Prepare the piquant cakes referring to pages 29-30. • Preheating is programmed for this menu, leave turntable in the oven during preheating and cooking. • After preheating, place prepared square tin in the lower shelf runner in the oven. • When the audible signals sound, remove the square tin and rotate it 90° and place in the lower shelf runner again. • After cooking, remove from square tin and serve on a plate.
Cake  (initial temp 20° C) e.g. Carrot cake, Gugelhupf, Apple cake with Calvados	0,5 - 1,5 kg (100 g) Baking tin and saucer Low rack	<ul style="list-style-type: none"> • Prepare the cook referring to the separate SHARP cookbook. • Put a saucer upside down on the low rack and place the baking tin on it. • After baking, let stand for approx. 10 minutes. • Remove the cake from the container.
Gratin  (initial temp 20° C) e.g. Courgette-pasta gratin, Broccoli- mushroom-pasta gratin	0,5 - 2,0 kg (100 g) Shallow, oval or round gratin dish Low rack	<ul style="list-style-type: none"> • Prepare the gratin referring to the separate SHARP cookbook. • Place the gratin dish on the low rack. • After cooking, let stand, covered with aluminium foil for approx 5 - 10 minutes.

RECIPES FOR INSTANT ACTION "PIQUANT CAKES"



ONION GATEAU

Utensils: Bowl with lid (3 l capacity)
 Square tin
 greaseproof paper

Ingredients - for the dough

375 g Flour
 30 g Yeast
 1 Egg
 125 ml Milk
 1/2 tsp. Salt
 75 g Butter

Ingredients - for the topping

650 g Onions
 100 g Streaky bacon
 30 g Butter
 Cheyenne pepper
 3 Eggs
 200 g Soured cream
 1/2 tsp. Salt

Preparation

This recipe makes approx. 1,6 kg.

1. Prepare from the mentioned ingredients a yeast dough. Cover the dough with heat-resistant film or a damp tea-cloth and allow to rise. Cook for 20 minutes on CONVECTION 40°C.
2. Peel and dice the onions and the streaky bacon. Place the butter, the onions and bacon in a bowl, cover and braise for 8-12 minutes (900 W). After cooking cool the mixture and blend the eggs, soured cream and salt into the mixture.
3. Preheating is programmed on INSTANT ACTION "Piquant Cakes" . Preheat the oven. Line the square tin with greaseproof paper. Roll out the dough and place inside the tin.
4. Spread the mixture evenly over the pastry case. Let the dough rise again before baking.
5. After preheating, place the square tin on lower level runner and press start.
6. When the audible signals sound and the oven stops, rotate the square tin by 90°.

ENGLISH



RECIPES FOR INSTANT ACTION "PIQUANT CAKES"

LEEK TART

Utensils: Bowl with lid (3 l capacity)
Square tin
greaseproof paper

Ingredients - for the dough

150 g Wholemeal flour
120 g Rye flour (type 1150)
(you can use normal flour type 405 instead)
4 tsp. Baking powder (12 g)
1 Egg
125 g Low fat yoghurt
1 1/2 tbsp. Vegetable oil
1/2 tsp. Salt

Ingredients - for the topping

450 g Leek, cut into rings
3 tbsp. Water
Salt
1 pinch Curry powder
150 g Soured cream
3 Eggs
2 tbsp. Wholemeal flour
Herb salt
Pepper
pinch Nutmeg
1 tsp. Parsley, chopped finely
1 tsp. Chives, chopped into small rings
1 tsp. Dill, chopped finely
100 g Grated Emmenthal cheese

Preparation

This recipe makes approx. 1,3 kg.

1. Place leek and water in a bowl. Cover and cook for 5-8 minutes on 900 W. Drain, add salt and curry powder to taste. Preheating is programmed on INSTANT ACTION "Piquant Cakes" . Preheat the oven.
2. Mix the flour and the baking powder. Add the egg, the yoghurt, oil and the salt. Blend together using the kneading hook on a hand-held blender.
3. Line the square tin with greaseproof paper. Roll out the dough and place inside the tin. Raise the rim by about 1 cm.
4. Stir the soured cream, eggs and flour together. Season with herb salt, pepper, nutmeg and herbs. Mix in the grated cheese.
5. Blend the mixture into the leek and spread it evenly over the pastry case.
6. After preheating, place the square tin on lower level runner and press start.
7. When the oven stops and the audible signal sounds, rotate the square tin by 90°.

PIZZA

Utensils: Square tin
greaseproof paper

Ingredients - for the dough

230 g Flour
20 g Yeast
1 tsp. Sugar
Salt
4 tsp. Oil
135 ml Lukewarm water

Ingredients - for the topping

250 g Tinned tomatoes, mashed
Basil, Oregano, Thyme, Salt, Pepper
250 g Topping as desired e.g. Pepper, Salami,
Mushrooms etc.
100 g Grated cheese

Preparation

This recipe makes approx. 1,0 kg.

1. Dissolve the yeast in lukewarm water.
2. Place the flour in a bowl and make a well in the centre. Add the yeast mixture to the flour and stir in gradually. Add salt and oil. Knead well.
3. Cover the dough with heat-resistant film or a damp tea-cloth and allow it to rise. Cook for 20 minutes on CONVECTION 40° C.
4. Preheating is programmed on INSTANT ACTION "Piquant Cakes" . Preheat the oven. Line the square tin with greaseproof paper. Roll out the dough and place inside the tin.
5. Cover the dough with the tomatoes. Season to taste and cover with the desired topping. Finally spread over the grated cheese.
6. After preheating, place the square tin on lower level runner and press start.
7. When the oven stops and the audible signal sounds, rotate the square tin by 90°.

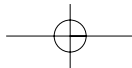

RECIPES FOR USING SQUARE TIN/SHELF



TURKEY BREAST IN ONION-CREAM SAUCE

Total Cooking time: 26 minutes

Utensils: Square tin

Ingredients

- 1000 g Turkey breast (9 pieces)
- 1 bag Onion soup mixture (dried, 1 bag for 750 ml)
- 500 ml Cream
- 200 g Mushrooms, sliced
- 9 slices Processed cheese

Preparation

1. Preheat the oven to 230° C.
2. Cut the turkey breast into similar sized pieces (9) and place on the square tin.
3. Mix together the dried onion soup with the cream (don't add water). Add the sliced mushrooms. Pour over the meat and finally cover with the cheese slices.
4. Place the square tin on lower level runner in the oven and cook for 26 minutes on CONVECTION 230° C.
5. After 16 minutes rotate the square tin by 90 degrees.

LASAGNE AL FORNO

Total Cooking time: 40-46 minutes

Utensils: Bowl with lid (3l capacity)
Rectangular gratin dish (35x29 cm)
Square shelf

Ingredients

- 600 g Tinned tomatoes
- 100 g Onion, finely chopped
- 100 g Ham, finely cubed
- 1 Clove of garlic, crushed
- 500 g Minced meat (beef)
- 4 tsps. Mashed tomato
- Salt, Pepper
- Oregano, Thyme, Basil
- 450 g Cream (crème fraîche)
- 300 ml Milk
- 100 g Grated Parmesan cheese
- 3 tsp. Mixed chopped herbs
- 2 tsp. Olive oil
- Salt, Pepper, Nutmeg
- 1 tsp. Vegetable oil to grease gratin dish
- 250 g Lasagne verde
- 2 tbsp. Grated Parmesan cheese
- 1 tbsp. Butter

Preparation

1. Cut the tomatoes into slices, mix with the ham and onion cubes, garlic, minced meat and mashed tomato. Season and cook with the lid on for 12-14 minutes on MICROWAVE 900 W.
2. Mix the cream with the milk, Parmesan cheese, herbs, oil and spices.
3. Preheat the oven to 250° C.
4. Grease the gratin dish and cover the bottom of the dish with about 1/3 of the pasta. Put half of the minced meat mixture on the pasta and pour on some sauce. Put an additional 1/3 of the pasta on top followed by another layer of the minced meat mixture and some sauce, finishing with the remaining pasta on top. Finally, cover the pasta with lots of sauce and sprinkle with Parmesan cheese. Place butterflakes on top and cook on the square shelf on lower level runner for 28-32 minutes on CONVECTION 250° C.

After cooking, let the lasagne stand for approx. 5-10 minutes.

ROQUEFORTTOAST

Total Cooking time: 15-18 minutes

Utensils: Square tin

Ingredients

- 9 Slices of bread for toasting
- butter
- 9 Slices of cooked ham
- 9 Half pears (tinned)
- 9 tsp. Cranberry jam
- 200 g Roquefort cheese

Preparation

1. Preheat the oven to 230° C.
2. Toast the bread and spread with butter.
3. Place one slice of ham on each slice of bread.
4. Slice the pears and place them partly overlapping on the ham. Put 1 tsp cranberry jam on each toast.
5. Cut the Roquefort in pieces and spread on the toasts.
6. Place on the square tin and cook on upper level runner for 15-18 minutes on CONVECTION 230° C. After 10 minutes rotate the square tin by 90 degrees.

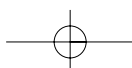



RECIPES FOR USING SQUARE TIN/SHELF

GYPSY'S ARM ROLL

Total Cooking time: 23-25 minutes

Utensils: Square tin
greaseproof paper

Ingredients - for the dough

4 Eggs
125 g Sugar
125 g Flour
1 tsp. Baking powder (3 g)

Ingredients - for the topping

250 ml Milk
1 Stick of cinnamon
The peel of a lemon
75 g Sugar
2 tbsps. Starch-flour (20 g)
2 Egg yolks
2 tbsps. Icing sugar (20 g)

Preparation

1. Cream the eggs and sugar using the hand-held blender, until it is frothy with air bubbles. Mix the flour and baking powder and sift over the egg and sugar mixture, then fold in carefully. Preheat the oven to 200° C.
2. Line the square tin with greaseproof paper, fill with the cake mixture and bake on lower level runner for 19-21 minutes on CONVECTION 200° C. After 10 minutes rotate the square tin by 90 degrees.
3. Turn out the cake onto a damp tea-cloth onto which you have sprinkled sugar. Carefully remove the greaseproof paper and immediately roll the cake up using the tea-cloth to assist you.
4. Place 200 ml of the milk with the cinnamon stick, lemon peel and sugar into the bowl, cover and heat for ca. 2 minutes on MICROWAVE 900 W.
5. Mix the rest of the milk with the starch-flour and the egg yolk. Take the lemon and cinnamon out of the 200 ml of milk, and stir in the starch-flour mixture. Cover and cook. Stir half-way through and at the end of cooking. Ca. 2 minutes on MICROWAVE 900 W.
6. Unroll the cake, brush on the cream mixture and then carefully roll it up again. Dust with icing sugar.

LINZER BISCUITS

Total Cooking time: 12-15 minutes

Utensils: Square tin
Square shelf
Bottom of a round baking tin (28 cm)
greaseproof paper

Preparation

1. Prepare the biscuits referring to the attached Sharp cookbook on page XX.
2. Preheat the oven to 230° C.
3. Line the square tin and the bottom of the baking tin with greaseproof paper. Place 20 biscuits on the square tin and 12 pieces on the round baking tin. Place the square tin on the lower level runner and the square shelf with the round baking tin on the upper level runner and bake for 12-15 minutes on CONVECTION 230° C.

Prepare the remaining dough in the same way.

CARE AND CLEANING



CAUTION! DO NOT USE COMMERCIAL OVEN CLEANERS, ABRASIVE, HARSH CLEANERS OR SCOURING PADS ON ANY PART OF YOUR MICROWAVE OVEN.

WARNING!

After **GRILL, DUAL, CONVECTION, EXPRESS COOK, POTATO** and **INSTANT ACTION** modes, the oven cavity, door, oven cabinet and accessories will become very hot. Before cleaning, make sure they are completely cool.

Oven exterior

The outside of your oven can be cleaned easily with mild soap and water. Make sure the soap is wiped off with a moist cloth, and dry the exterior with a soft towel.

Oven controls

Open the door before cleaning to de-activate the oven controls. Care should be taken when cleaning the oven control. Using a cloth dampened with water only, gently wipe the panel until it becomes clean. Avoid using excessive amounts of water. Do not use any sort of chemical or abrasive cleaner.

Oven Interior

1. For cleaning, wipe any splatters or spills with a soft damp cloth or sponge after each use while the oven is still warm. For heavier spills, use a mild soap and wipe several times with a damp cloth until all residues are removed.

Built-up splashes may overheat and begin to smoke or catch fire, and cause arcing.

Do not remove the waveguide cover.

- 2.** Make sure that mild soap or water does not penetrate the small vents in the walls which may cause damage to the oven.
- 3.** Do not use spray type cleaners on the oven interior.
- 4.** Heat up your oven regularly by using the convection and grill, refer to "Heating without food" on page 11. Remaining food or fat splashed can cause smoke or bad smell.

Accessories

The accessories should be washed in a mild washing up liquid solution and dried. They are dishwasher safe.

Door

To remove all trace of dirt, regularly clean both sides of the door, the door seals and adjacent parts with a soft, damp cloth.

NOTE: Keep the waveguide cover and accessories clean at all times. If you leave grease or fat in the cavity or accessories, it may overheat, cause arcing, smoke or even catch fire when next using the oven.



SERVICE CALL CHECK

PLEASE CHECK THE FOLLOWING BEFORE CALLING FOR SERVICE.

1. Power Supply

Check the power plug is properly connected to a suitable wall outlet.

Check the line fuse/circuit breaker is functioning properly.

2. When the door is opened, does the oven lamp light? YES _____ NO _____

3. Place a cup of water (approx. 150 ml) in the oven and close the door securely.

Set the cooking mode to microwave cooking mode.

Programme the oven for one minute on 900 W power and start the oven.

Does the oven lamp light? YES _____ NO _____

Does the turntable rotate? YES _____ NO _____

NOTE: The turntable turns in either direction.

Does the ventilation work? YES _____ NO _____

(Place your hand over the ventilation openings and check for air flow.)

After 1 minute does the signal sound? YES _____ NO _____

Does cooking in progress indicator go off? YES _____ NO _____

Is the water warm after the above operation? YES _____ NO _____

4. Take the cup out of the oven and close the door.

Set the **GRILL** cooking mode  for 3 minutes.

After 3 minutes does the grill heating element become red? YES _____ NO _____

5. Set the **CONVECTION** cooking mode  for three minutes at 250° C.



Is the inside of the oven hot after 3 minutes? YES _____ NO _____

If you answer "NO" to any of the above questions, call a Service Technician appointed by SHARP and report the results of your check. See inside back cover for details of address.

IMPORTANT: If the display shows nothing even if the power plug is properly connected, the energy save mode should carry on. To release it, open and then close the oven door. See page 9.

NOTES:

- If you cook the food over the standard time with only the same cooking mode, the power of the oven will lower automatically to avoid overheating. (The microwave power level will be reduced and the grill heating elements will begin to light on and off.)

Cooking mode	Standard time
Microwave 900 W cooking	20 min.
Grill cooking	15 min.
Dual 1  (630 W microwave power)	Micro - 40 min.
Dual 2  (900 W microwave power)	Micro - 15 min. Grill - 15 min.
Dual 2  (630 W microwave power)	Micro - 40 min. Grill - 15 min.

- After **GRILL, DUAL, CONVECTION, EXPRESS COOK, POTATO** and **INSTANT ACTION**, the cooling fan will run and "NOW COOLING" may appear on the display. Also, when you press the **STOP** key and open the door during these cooking modes, the cooling fan will run; you may, therefore, feel air blowing from the ventilation openings.

SPECIFICATIONS



AC Line Voltage	:	230 V, 50 Hz, single phase
Distribution line fuse/circuit breaker	:	Minimum 16 A
AC Power required:		
Microwave	:	1.5 kW
Grill	:	2.65 kW
Grill/Microwave	:	2.8 kW
Convection	:	2.75 kW
Convection/Microwave	:	2.9 kW
Output power:		
Microwave	:	900 W (IEC 60705)
Grill heating elements	:	1300 W (650 W x2)
Convection	:	1400 W
Microwave Frequency	:	2450 MHz
Outside Dimensions	:	550 mm (W) x 368 mm (H) x 537 mm (D)
Cavity Dimensions	:	375 mm (W) x 272 mm (H) x 395 mm (D)
Oven Capacity	:	40 litres
Turntable	:	ø362 mm, ceramic
Weight	:	24 kg
Oven lamp	:	25 W/240 - 250 V

This oven complies with the requirements of Directives 89/336/EEC and 73/23/EEC as amended by 93/68/EEC.

SPECIFICATIONS ARE SUBJECT TO CHANGE WITHOUT NOTICE AS PART OF
CONTINUOUS IMPROVEMENT

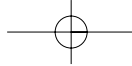

• SERVICE NIEDERLASSUNGEN • ADDRESSES D'ENTRETIEN • ONDERHOUDSADRESSEN • DIRECCIONES DE SERVICIO • INDIRIZZI DI SERVIZIO •

ÖSTERREICH

Bei einer Reklamation Ihrer SHARP Mikrowelle wenden Sie sich bitte an Ihren Fachhändler oder an eine der nachfolgend aufgeführten SHARP SERVICE Niederlassungen.

MCL - Service Ges.m.b.H., Deutschstrasse 19, A-1232 Wien, Phone: 0043 1 / 616 88 00-12, Fax: 00431 / 616 88 00-15 / **MAYER Manfred GmbH.**, Stipcakgasse 6, A-1234 Wien, Phone: 0043 1 / 609 31 20, Fax: 0043 1 / 699 36 29 / **REITMEIR Anton Radio Videoelektronik**, Leopoldstrasse 57, A-6020 Innsbruck, Phone: 0043 512 / 56 22 777, Fax: 0043 512 / 56 22 77 / **AUDIO VIDEO SERVICE Ges.m.b.H.**, Feldkirchnerstraße 104, A-9020 Klagenfurt, Phone: 0043 463 / 43 113/14, Fax: 0043 463 / 43 113-85 / **SCHEUERMANN Tele Service**, Rennsteinerstraße 8, A-9500 Villach, Phone: 0043 4242 / 21 174, Fax: 0043 4242 / 21 174-4 / **AVH-PICHLER**, Am Wagrain 342, A-8055 Graz, Phone: 0043 316 / 291292, Fax: 0043 316 / 29 12 92-6 / **MOSER Arnold RADIO - TV**, An der Heufurt 28, A-6900 Bregenz, Phone: 0043 5574 / 75 777, Fax: 0043 5574 / 75 777-4 / **SCHUHMANN Gesellschaft m.b.H**, Gablonzerweg 18, A-4030 Linz, Phone: 0043 732 / 382 280, Fax: 0043 732 / 382 280-8 / **GÖSCHL Roland**, Bayerhammerstr. 12 c, A-5020 Salzburg, Phone: 0043 662 / 88 23 07, Fax: 0043 662 / 88 19 26.

BELGIUM

En cas d'une réclamation concernant une four a micro-onde SHARP, nous vous prions de vous adresser à votre spécialiste ou à une adresse des SHARP Services suivantes.

Indien uw magnetron problemen geeft kunt u zich wenden tot uw dealer of een van de onderstaande Sharp service centra.

AVTC, Kleine Winkellaan 54, 1853 Strombeek-Bever, Phone:02/2674019, Fax:2679670,

ETS HENROTTE,Rue Du Campinaire 154,6240 Farciennes, Phone: 071/396290, Fax:391237

Nouvelle Central Radio (N.G.R) Rue des Joncs 15 L-1818 HOWALD Phone: 00352404078, Fax. 2402085

NEDERLAND

Indien uw magnetron problemen geeft kunt u zich wenden tot uw dealer of naar onderstaand Sharp Service Centrum.

SHARP ELECTRONICS BENELUX BV, - Helpdesk -,Postbus 900,3990 DW Houten, Telefoon: 09-007427728, Fax: 030-6359621

DEUTSCHLAND

Bei einer Reklamation Ihrer SHARP Mikrowelle wenden Sie sich bitte an Ihren Fachhändler oder an eine der nachfolgend aufgeführten SHARP SERVICE Niederlassungen.

03048 Groß Garglow, Cottbuser Str.129, Bernd Mindach, Tel: 0355-539987, Fax: 0355-5265685 / **04159 Leipzig**, Max-Liebermann-Straße 4 a, Rudi Franz, Tel: 0341-9112525, Fax: 0341-9112526 / **04600 Altenburg**, Gabelentzstraße 15 A, Mechanik Altenburg E.G., Tel: 03447-311102, 03447-315253 / **06217 Merseburg**, Gothardstraße 30, Looke & May GmbH, Tel: 03461-214121 Fax: 03461-216891 / **06295 Eisleben**, Hallesche Straße 36, Hausger. Kundend. Eisleben, Tel: 03475-603079, Fax: 03475-747262 / **06618 Naumburg**, Roßbacher Straße 7, Elektro Schröter, Tel: 03445-200268, Fax: 03445-200269 / **06618 Naumburg**, Wenzelstraße 15, Hausgeräte & Service GmbH, Tel: 03445-202016 Fax: 03445-202016 / **06844 Dessau**, Albrechtstraße 116-118, Dessau-Electric GmbH, Tel: 0340-213331, Fax: 0340-213332 / **07407 Rudolstadt**, Emil Hartmann Straße 2, Elektro Ernst Granowski, Tel: 03672-352123, Fax: 03672-357097 / **07545 Gera**, Amthorstraße 12, Ess Hardware Service GmbH, Tel: 0365-8820115, Fax: 0365-8820116 / **07973 Greiz**, Reichenbacher Straße 44 d, Elektro Riederer Haushaltgeräte, Tel: 03661-3148, Fax: 03661-430142 / **08280 Aue**, Bahnhofstraße 21, EHS Elektro-Hausgeräte SVC GmbH, Tel: 03771-552222 Fax: 03771-552255 / **08523 Plauen**, Weststraße 63, Elektrotechnik Plauen GmbH, Tel: 03741-2120, Fax: 03741-212259 / **09221 Neukirchen**, Hauptstraße 74, Walther Elektro, Tel: 0371-217096, Fax: 0371-217090 / **09246 Pleiße**, Zeppelinstraße 8 a, Hans Krempel Haustechnik GmbH, Tel: 03722-73780, Fax: 03722-737822 / **09328 Lunzenau**, Schulstraße 6, Peter Welsch GmbH, Tel: 037383-6434, Fax: 037383-6448 / **09376 Oelsnitz**, Bahnhofstraße 43, Elektrotechnik Oelsnitz-GmbH, Tel: 037298-2677, Fax: 037298-2678 / **12157 Berlin**, Cranachstraße 2, Michael Kittler, Tel: 030-8551335, Fax: 030-8554835 / **18055 Rostock**, Mühlendamm 5, Hetec, Tel: 0381-36231, Fax: 0381-36231 / **18435 Stralsund**, Kedingshäger Straße 78, RDS Haushaltsgeräte GmbH, Tel: 03831-391426, Fax: 03831-390121 / **20357 Hamburg**, Schulterblatt 132, Dieter Möller, Tel: 040-435332, Fax: 040-4302120 / **20537 Hamburg**, Eiffestraße 398, Deubel+Höfermann Elektronik GmbH, Tel: 040-257227, Fax: 040-2500192 / **22459 Hamburg**, Seesrein 35, Dieter A. Volbrecht VDI Klima und Kälte Service, Tel: 040 - 5517331, Fax: 040 - 5519996 / **23562 Lübeck**, Helmholtzstraße 12, Lutz H. Boenisch, Tel: 0451-51929, Fax: 0451-56787 / **24116 Kiel**, Eckernförder Straße 93, Jürgen Skop GmbH, Tel: 0431-13038, Fax: 0431-13811 / **24357 Fleckeby**, Südring 14, Kaack Elektro-Haushaltgeräte Service GmbH, Tel: 04354-700, Fax: 04354-1311 / **24975 Husby**, Flensburger Straße 41, Günter Josten, Tel: 04634-422, Fax: 04634-723 / **25770 Hemmingstedt**, Koesliner Straße 18, Dirk Stübner Dithmarscher Hausgeräte Service, Tel: 0481-64943, Fax: 0481-64764 / **26655 Westerstede**, Südring 37, Gerhard Ahrenholtz GmbH, Tel: 04488-84770, Fax: 04488-847711 / **27404 Heeslingen**, Kirchstraße 9-11, Helmut Willenbrock Elektro-Kälte-Radio, Tel: 04281-1031, Fax: 04281-6467 / **27478 Cuxhaven**, Am Kanal 5, Oskar Wieandt & Sohn OHG, Tel: 04724-81300, Fax: 04724-813050 / **28207 Bremen**, Neidenburger Straße 20, Hansa Haushaltsgeräte

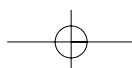

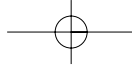

• SERVICE NIEDERLASSUNGEN • ADDRESSES D'ENTRETIEN • ONDERHOUDSADRESSEN • DIRECCIONES DE SERVICIO • INDIRIZZI DI SERVIZIO •

Service GmbH, Tel: 0421-492526, Fax: 0421-440932 / **29439 Lüchow**, Güldenboden 25, Elektro-Kittler, Tel: 05841-3322, Fax: 05841-3322 / **30926 Seelze**, Lange-Feld-Straße 122, Strickling Werkskundendienst, Tel: 0511-400399-9, Fax: 0511-40039920 / **34123 Kassel**, Heinrich-Hertz-Straße 9, KälteDienst v. Rappard, Tel: 0561-5809545, Fax: 0561-5809570 / **34128 Kassel**, Ahnatalstraße 84, Elektro Mohrhenne, Tel: 0561-61727, Fax: 0561-65470 / **35037 Marburg**, Wilhelmstraße 16, Hans-Georg Fuchs, Tel: 06421-22424, Fax: 06421-27549 / **35415 Pohlheim**, Ludwigstraße 13-15, Jung KDZ, Tel: 06403-61131, Fax: 06403-62151 / **37671 Höxter**, Krämerstraße 8, Elektro Nonn, Tel: 05271-7959, Fax: 05271-35053 / **38440 Wolfsburg**, Grauhorststraße 16, Gärtner Elektro-Haustechnik, Tel: 05361-30310, Fax: 05361-31272 / **39106 Magdeburg**, Ankerstr. 9, Industrie-Elektronik Magdeburg GmbH, Tel: 0391-5430402, Fax: 0391-5433520 / **40476 Düsseldorf**, Rather Straße 21, Horst Leven, Tel: 0211-486025, Fax: 0211-443399 / **41065 Mönchengladbach**, Gutenbergstraße 28, Horst Hommers Kundendienst-Center, Tel: 02161-603256u.57, Fax: 02161-651951 / **42781 Haan**, Talstraße 8 b, Horst Kerkühn Elektro-Haustechnik, Tel: 02129-4466+53550, Fax: 02129-34037 / **44357 Dortmund**, Freigrafenweg 23-29, Gehado Elektronik Service GmbH, Tel: 0231-9370000, Fax: 0231-93700078+44 / **44869 Bochum**, Ruhrstraße 181, ML Werks-Service GmbH, Tel: 02327-77899, Fax: 02327-74692 / **45219 Essen**, Corneliusstraße 39, R. Drengenburg, Tel: 02054-84114, Fax: 02054-15238 / **46045 Oberhausen**, Feldmannstraße 76, Dieter Kroppen, Tel: 0208-871711, Fax: 0208-876652 / **48165 Münster-Hiltrup**, Rohrkampstraße 23, Günter Pfeifer Großküchentechnik, Tel: 02501-3033, Fax: 02501-24277 / **49324 Melle**, Plettenberger Straße 50, H. U. Borgards GmbH, Tel: 05422-949740, Fax: 05422-9497-92 / **51598 Friesenhagen**, Mühlenhof 6, Hans Krempl Haustechnik GmbH, Tel: 02734-7377, Fax: 02734-40618 / **52146 Würselen**, De Gasperistraße 6+10, Hubert Hamacher, Tel: 02405-9600+9609, Fax: 02405-2704 / **53757 Sankt Augustin**, Kölnstraße 4, HDL Elektro-Kundendienst GmbH, Tel: 02241-920330, Fax: 02241-920334 / **55130 Mainz**, Nur telefonische Annahmestelle, Norbert Schwamb GmbH, Tel: 06131-881070 / **55543 Bad Kreuznach**, Industriestraße, Hans Krempl Haustechnik GmbH, Tel: 0671-794331, Fax: 0671-794369 / **56070 Koblenz**, August-Horch-Straße 14, Hans Krempl Haustechnik GmbH, Tel: 0261-8909173, Fax: 0261-8909199 / **57080 Siegen**, Gosenbacher Hütte 44, Hans Krempl Haustechnik GmbH, Tel: 0271-354114, Fax: 0271-351408 / **58239 Schwerte**, Holzener Weg 79, HHKT Electronica 2000 Josef Schlütz GmbH, Tel: 02304-982100, Fax: 02304-86360 / **61381 Friedrichsdorf**, Bahnstraße 17 a, O. Hollmann, Tel: 06172-778276, Fax: 06172-75883 / **63739 Aschaffenburg**, Maximilianstraße 8, Radio-Fernseh Reis, Tel: 06021-15177, Fax: 06021-15199 / **65239 Hochheim**, Eltviller Straße 14, Norbert Schwamb GmbH, Tel: 06146-4085, Fax: 06146-4088 / **65627 Elbtal-Hangenmeilingen**, Am Ohlenrod 10, Rudi Wagner, Tel: 06436-3444, Fax: 06436-3444 / **65931 Frankfurt**, Nur telef. Annahmestelle, Norbert Schwamb GmbH, Tel: 069-371525 / **66117 Saarbrücken**, Zinzinger Straße 13, Hans Krempl Haustechnik GmbH, Tel: 0681-5008522, Fax: 0681-5008533 / **67434 Neustadt**, Saarlandstraße 55, Hans Krempl Haustechnik GmbH, Tel: 06321-83077, Fax: 06321-83077 / **68309 Mannheim**, Heppenheimerstraße 23, Hans Krempl Haustechnik GmbH, Tel: 0621-737978, Fax: 0621-722404 / **68526 Ladenburg**, Brauergasse 2, Salinger Elektro Service, Tel: 06203-3341, Fax: 06203-16919 / **70186 Stuttgart**, Klippeneck Straße 1, Elektro Herterich Techn. Kundendienst, Tel: 0711-4687023, Fax: 0711-4687024 / **75236 Kämpfelbach**, Goethestraße 19, Horst Frei, Tel: 07232-1518, Fax: 07232-5238 / **76185 Karlsruhe**, Lotzbeckstraße 9, Electronic Service Franke, Tel: 0721-5700720-23, Fax: 0721-5700736 / **76872 Winden**, Hauptstraße 103, Hans Krempl Haustechnik GmbH, Tel: 06349-8571, Fax: 06349-3390 / **78462 Konstanz**, Nur telef. Annahmestelle, Elektro Herterich, Tel: 07531-27923 / **78737 Fluorn-Winzeln**, Schafbaumstraße 9, Edmund Schneider, Tel: 07402-482, Fax: 07402-8014 / **79650 Schopfheim**, Feldbergstraße 21, R. Grossmann, Tel: 07622-7673, Fax: 07622-61900 / **80339 München**, Schwantthalerstraße 110, Kesel & Schnitt, Tel: 089-505802, Fax: 089-5021596 / **85095 Denkendorf-Zandt**, Michlstraße 3, Elektro Pfeiffer, Tel: 08466-1319, Fax: 08466-1319 / **85413 Hörgertshausen**, Schlosstraße 7, Elektro Radlmaier, Tel: 08764-9306-0, Fax: 08764-9306-30 / **86157 Augsburg**, Stadtberger Straße 67, J. Haslinger Elektro-Geräte Kundendienst, Tel: 0821-523125, Fax: 0821-526664 / **87439 Kempten**, Heiligkreuzer Straße 17, Radio Hartmann, Tel: 0831-594646, Fax: 0831-91319 / **89231 Neu-Ulm**, Gartenstraße 4, Elektrotechnik Schneider, Tel: 0731-85897, Fax: 0731-74681 / **91522 Ansbach**, Am Ring 17, Elektro Merk GmbH, Tel: 0981-89574, Fax: 0981-86715 / **93102 Pfatter**, Regensburger Straße 60, Franz Bernhard, Tel: 09481-90060, Fax: 09481-90061 / **94130 Oberzell**, Hameter Straße 31, Elektro Service Schurig, Tel: 08591-2400, Fax: 08591-1285 / **96052 Bamberg**, Aronstraße 2 a, Bernhard Jackl, Tel: 0951-9370245, Fax: 0951-9370247 / **97070 Würzburg**, Untere Johanniergasse 16, Radio Wels City Service GmbH, Tel: 0931-3557119, Fax: 0931-14151 / **97318 Kitzingen**, Herrnstraße 4-6, Hoffritz GmbH, Tel: 09321-4221-32021, Fax: 09321-32185 / **98724 Neuhaus**, Eisfelder Straße 32, DLC Haustechnik GmbH, Tel: 03679-79060, Fax: 03679-790620 / **99096 Erfurt**, Goethestraße 14, Ernst Grüsser, Tel: 0361-3465719, Fax: 0361-3465719 / **99734 Nordhausen**, Töpferstraße 10, Südharzer Dienstleistungs-Gesellschaft GmbH, Tel: 03631-983651, Fax: 03631-983654 / **99817 Eisenach**, Bahnhofstraße 17, Blitz Elektro-Elektronik GmbH, Tel: 03691-292930, Fax: 03691-292915.

FRANCE

En cas de réclamation pour les fours micro-ondes SHARP, nous vous prions de vous adresser à votre spécialiste ou à l'une des stations techniques agréées SHARP suivantes :

A.A.V.I.: 1, Rue du Mont de Terre, 59818 Lesquin Cédex. Tél: 03 20 62 18 98 - Fax: 03 20 86 20 60. Départements desservis: 02, 08, 59, 62, 80 / **ATELIER ROUSSEL:** 12, Bld Flandre Dunkerque, 56100 Lorient. Tél: 02 97 83 07 41 - Fax: 02 97 87 02 36. Départements desservis: 22,29,35,44,56 / **C.E.A.T.:** 9, Rue de Venise, 21000 Dijon. Tél: 03

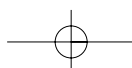

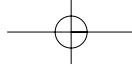

• SERVICE NIEDERLASSUNGEN • ADDRESSES D'ENTRETIEN • ONDERHOUDSADRESSEN • DIRECCIONES DE SERVICIO • INDIRIZZI DI SERVIZIO •

80 66 15 57 - Fax: 03 80 67 12 36. Départements desservis: 10,21,25,39,52,58,71,89 / **C.M.T.S.**: 38, Rue des Ormeaux, 75020 Paris. Tél: 01 43 70 20 00 - Fax: 01 43 70 36 46. Départements desservis: 75,77,78,91,92,93,94,95 / **C.T.E.**: Zone Tilly - 116 rte de Thionville, 57140 Woippy. Tél: 03 87 30 14 14 - Fax: 03 87 30 85 07. Départements desservis: 51,54,55,57,88 / **ELECTRO SERVICE**: 21 rue de Mulhouse, BP 122, 68313 ILLZACH. Tél: 03 89 62 50 00 - Fax: 03 89 50 80 14. Départements desservis: 67,68,70,90 / **ELECTRONIQUE SERVICE MARSEILLE**: 73 boulevard Saint Marcel, 13011 Marseille. Tél: 04 91 45 06 85 - Fax: 04 91 45 08 05 / **M.E.C.**: 118 Bld Tonnelle, 37020 Tours. Tél: 02 47 77 90 90 - Fax: 02 47 77 90 91. Départements desservis: 18,36,37, 41,45,44,49,79,85,86 / **M.R.T.**: 74, Rue Albert Einstein, 72021 Le Mans Cedex. Tél: 02 43 28 52 20 - Fax: 02 43 24 93 81. Départements desservis: 28,53,61,72 / **ROSSIGNOL**: ZL du Brezet Est, 6 rue P. Boulanger, 63100 Clermont Ferrand. Tél: 73 91 93 09, Fax: 73 92 28 79. Départements desservis: 3, 15, 19, 23, 43, 63 / **S.T.E.**: 3, Chemin de l'Industrie, 06110 Le Cannet Rocheville. Tél: 93 46 05 00 - Fax: 93 46 51 18. Départements desservis: 04,06 / **S.T.V.S.**: 18, Rue Benoit Malon, 42000 Saint Etienne. Tél: 77 32 74 57, Fax: 77 37 45 29. Départements desservis: 03,07,42,43,63 / **S.T.V.S.**: 10, Chemin Saint-Gobain, 69190 Saint Fons. Tél: 78 70 03 32 - Fax: 78 70 86 61. Départements desservis: 01,38,69,71,73,74 / **TECH SERVICE**: Batiment G-impasse Boudeville, 31100 Toulouse. Tél: 61 44 98 45 - Fax: 62 14 16 13. Départements desservis: 09,11,31,32,33, 40,47,64,65,66,81,82 / **TIMO VIDEO**: 29 rue Elisabeth, 91330 Yerres. Tél: 69 48 04 80 - Fax: 69 83 36 10. Départements desservis: 28, 45, 77, 89, 912, 94 / **U.N.T.D.**: 1, Rue des Lourdines, 76000 Rouen. Tél: 35 72 28 04 - Fax: 35 73 18 32. Départements desservis: 14,27,50,76 / **VIDEO TECHNOLOGY**: 8 allée Prefontaine aux Tournalles Z.I., 77230 Saint Mard. Tel: 01 60 54 99 44 - Fax: 01 60 54 99 45.

ITALIA

NEL CASO SI VERIFICASSERO PROBLEMI ALLA VOSTRA APPARECCHIATURA POTRETE RIVOLGERVI PRESSO UN NOSTRO CENTRO DI ASSISTENZA AUTORIZZATO SHARP

Microcentro, Via Falloppio 11, 20100 Milano, Phone: 02-26827306 / **Rota G.**, Via Martinella 65, 24020 Torre Boldone (BG), Phone: 035-344492 / **ServiceTVA**, Via Vergnano 59, 25127 Brescia, Phone: 011-2296000, Fax: 011253921 / **Tre Esse**, Via M. Coppino 96/e, 10147 Torino, Phone: 011-2296000, Fax: 011-253921 / **Video Service s.n.c.**, Via Giordano 52/54, 16100 Genova, Phone: 010-6043580 / **Tecnoservice s.n.c.**, Via San Vigilio 64/b-c-d, 39100 Bolzano, Phone: 0471-289062 / **Campi**, Via Noalese 87, 31100 Treviso, Phone: 0422-436245, Fax: 0422-435996 / **Video Service**, Via Vitruvio 11, 37100 Verona, Phone: 045-566299, Fax: 045-573865 / **Video Hi-fi**, Via Longhi 16 a/b, 40128 Bologna, Phone: 051-360986, Fax: 051-366863 / **Aerre Digit**, Via Marbellini 10/12, 50127 Firenze, Phone: 055-410874, Fax: 055-411490 / **Saec di Coppa**, Via Rinchiostro Nord 34, 54100 Massa, Phone: 0585-251724, Fax: 0585-791177 / **Tecniconsult**, Via Mad. Alta 185, 06100Perugia, Phone: 075-5003089 / **Digitecnica s.n.c.**, Via Zuccarini 1- Zona Baraccola, 60131 Candia (AN) Phone :071-2866067 / **S.A.R.E. s.r.l.**, Via Barbana 35/37, 00142 Roma, Phone 06-5406796 / **Tecno Labs**, Via Naz. Delle Puglie 294, 80026 Casoria (NA), Phone: 081-5845923 / **Marcantonio**, Via G.M.Giovane 45, 70124 Bari, Phone: 080-5618029 / **Audio Video**, Via A. de Gasperi 44, 88018 Vibo Valentia, Phone: 0963-45571/2 / **A.V.S.**, Via Sassari2/c, 95100 Catania, Phone: 095-446696, Fax: 095-434337 / **AS. TEC.**, Via R. Villasanta 227, 09100 Cagliari, Phone: 070-524153, Fax: 070-504109

ESPAÑA

En caso de una reclamación con vuestra SHARP Microwave, preguntan por favor la casa dónde han comprado su máquina o infórmense en una de las SHARP Service casas siguientes.

MERINO NICOLAS JOSE A., - 945/ 25.18.92 - AV JUDIZMENDI 24, 01003 VITORIA-GASTEIZ, ALAVA / **TELE-COLOR** - 96/585.24.60, CL DEL VENT 9, 03500 BENIDORM, ALICANTE / **TELECOM ELECTRONICA** - 96/539.50.21, CL HERNAN CORTES 8, 03600 ELDA, ALICANTE / **EUROSAT, S.L.** - 96/525.80.40, CL MONTERO RIOS 33 03013 ALICANTE, ALICANTE / **ELECTRONICA GOMEZ** - 96/ 546.75.81, CL BALTASAR TRISTANY 100, 03201 ELCHE, ALICANTE / **ANGEL AVELLAN PUIG** - 965/ 21.32.55, CL POETA QUINTANA 13, 03004 ALICANTE, ALICANTE / **ELECTRONICA ELER** - 965/ 25.63.32, CL PINOSO 8, 03012 ALICANTE, ALICANTE / **INSAT, CB** - 971/ 36.53.18, CL PINTOR CALBO 30, 07703 MAHON, BALEARES (MENORCA) / **REPARACIONES ORTEGA** - 971/ 39.01.55, CL VIA PUNICA 33, 07800 IBIZA, BALEARES (IBIZA). / **AUDIO IMAGEN** - 971/ 31.46.59, CL JOSE RIQUER LLOBET 8, 07800 IBIZA, BALEARES (IBIZA) / **IRTESA ELECTRONICA** - 971/ 20.47.02, CL JAUME FERRAN 72 BJOS, 07004 PALMA DE MALLORCA, BALEARES (MALLORCA) / **INSTALACIONES MAES, S.L.** - 971/ 27.49.47, CL SON NADAL 63, 07008 PALMA DE MALLORCA, BALEARES (MALLORCA) / **ELECTRON. PONS GOMILA SA** - 971/ 37.22.76, CR NUEVA 162, 07730 ALAYOR, BALEARES (MENORCA) / **JOSE MARQUES ANGLADA, S.L.** - 971/ 38.54.54, CL LEPANTO 19, 07760 CIUDADELA, BALEARES (MENORCA) / **ANOIA ELECTROVISIO** - 93/ 805.11.90, AV BALMES 12, 08700 IGUALADA, BARCELONA / **AUDIO VISION** - 385.78.08, CL MARE DEU MONTSERRAT 22, 08922 STA.COLOMA, BARCELONA / **SAC-2, S.C.P.** - 331.77.54, CL RIERA BLANCA 113, 08028 BARCELONA, BARCELONA / **FERMO** - 465.22.00, AV MORERA 5, 08915 BADALONA, BARCELONA / **ELEC.SAFONT** - 821.30.03, CL GRAL. MANSO SOLA 31, 08600 BERGA, BARCELONA / **SERVINTERS, S.C.C.L.** - 389.44.60 - PZ CASAGEMES 20, 08911 BADALONA, BARCELONA / **TECNIK'S, S.C.P.** - 630.11.20, CL JOAN BARDINA 32, 08830 SANT BOI DE LL, BARCELONA / **CE. VA. SAT, S.C.** - 785.51.11, CR MATADEPERA 87, 08225 TERRASSA, BARCELONA / **LAUREA S.A.T.** - 889.02.48, CL GUILLERIES BIS 20, 08500 VIC, BARCELONA / **CE. VA. SAT, S.C.** - 710.76.13, PS RUBIO I

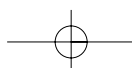

· SERVICE NIEDERLASSUNGEN · ADDRESSES D'ENTRETIEN · ONDERHOUDSADRESSEN · DIRECCIONES DE SERVICIO · INDIRIZZI DI SERVIZIO ·

ORS 105, 08203 SABADELL, BARCELONA / **VILLARET POLO RAMON** - 798.02.48, CL MOLI DE VENT 21, 08303 MATARO, BARCELONA / **ESTARLICH PRADAS VICENTE** - 766.22.33, CL INDUSTRIA 131, 08370 CALELLA, BARCELONA / **VIDEOCOLOR** - 93/ 454.99.08, CL VILLARROEL 44, 08011 BARCELONA, BARCELONA / **ELDE** - 872.85.42, CL BRUCH 55, 08240 MANRESA, BARCELONA / **PULGAR I EDO S.L.** - 93/ 436.44.11, CL CASTILLEJOS 333, 08025 BARCELONA, BARCELONA / **ELECTRONICA MATEOS** - 849.28.77, CR DE CALDAS (BAJOS) 76, 08400 GRANOLLERS, BARCELONA / **ANTONIO ROBLES SANCHEZ** - 872.55.41, CL SANT BARTOMEU 42, 08240 MANRESA, BARCELONA / **TOP ELECTRONICA**, 890.35.91, CL MISSER RUFET 4 bjos, 08720 VILAFRANCA PENEDES, BARCELONA / **LA CLINICA DEL ELECTROD.**, 93/ 236.44.11, CL BALMES 160, 08008 BARCELONA, BARCELONA / **FIX SERVICIO TECNICO**, 675.59.02, CL SANT RAMON 3 L2, 08190 SANT CUGAT VALLES, BARCELONA / **SONITEV ELECTRONICA, C.B.**, 815.74.44, CL AIGUA 143, 08800 VILANOVA I GEITRU, BARCELONA / **TOTVISIO ELECTRONICA S.L.**, 873.88.81, PJ FERRER 14, 08240 MANRESA, BARCELONA / **4 EN 1 REPARACIONES**, 430.97.2, CL TAQUIGRAFO MARTI 19, 08028 BARCELONA, BARCELONA / **MOVILFRIT S.A.**, 93/ 630.14.53, CL OSCA 11-C POL.SALINAS, 08830 SANT BOI DE LL., BARCELONA / **TELE-SERVEI BRUC S.L.**, 93/ 207.08.08, CL ROSSELLO 289, 08037 BARCELONA, BARCELONA / **SABE ELECTRONICA**, 964/ 21.52.65, CL JOAQUIN COSTA 46, 12004 CASTELLON, CASTELLON / **F.CARCELLER-F.CERVERA, C.B.**, 964/ 45.44.65, CL CARRERO 29, 12500 VINAROS, CASTELLON / **ASISTE, S.L.**, 964/ 21.57.69, AV DE VALENCIA NAVE 19, 12006 CASTELLON, CASTELLON / **TECHNOTRONIC**, 971/ 32.27.62, CL IBIZA 12, 07860 SAN FCO. JAVIER, FORMENTERA / **REPARACIONES PILSA S.C.**, 972/ 20.66.96, CL J. PASCUAL I PRATS 8, 17004 GERONA, GERONA / **SATEL**, 972/ 26.55.19, PS DE BARCELONA 12, 17800 OLOT, GIRONA / **SALLERAS PUIG JUAN**, 972/ 50.67.54, CL POU ARTESIA 4, 17600 FIGUERES, GIRONA / **RIERA DAVIU**, 972/ 50.32.64, CL TORRAS Y BAGES 19, 17600 FIGUERES, GIRONA / **LAVISON, C.B.**, 972/ 23.01.22, CL MONTSENY 35, 17005 GIRONA, GIRONA / **MONJE URE#A MANUEL**, 972/ 70.25.52, CL SANT QUINTI 33, 17534 RIBES DE FRESE, GIRONA / **ESTUDIOS 3, C.B.**, 943/ 45.37.97, PZ DE LOS ESTUDIOS 3, 20011 SAN SEBASTIAN, GUIPUZCOA / **NOMBRE1, TLFNO, CALLE, CIUDAD, PROVINCIA / TEKNIBAT ELECTRONICA**, 943/ 70.24.37, CL ZEZENBIDE 4, 20600 EIBAR, GUIPUZCOA / **REPARACIONES URRUTI S.L.**, 943/ 45.84.10, PS AINTZIETA 32, 20014 SAN SEBASTIAN, GUIPUZCOA / **TELESERVIC**, 974/ 31.34.44, CL ESTADILLA 6, 22300 BARBASTRO, HUESCA / **SERVIELECTRO**, 974/ 21.00.14, CL BALTASAR GRACIAN 5, 22002 HUESCA, HUESCA / **TELESONIC**, 974/ 36.32.97, CL TERUEL 6, 22700 JACA, HUESCA / **TELESERVICIO**, 974/ 22.01.39, CL TENERIAS 20, 22001 HUESCA, HUESCA / **SATEF**, 973/ 50.08.48, AV RAVAL DEL CARME 12, 25300 TARREGA, LERIDA / **IELSA, C.B.**, 973/ 24.71.27, CL TARRAGONA 40, 25005 LLEIDA, LLEIDA / **CRISTEL**, 973/ 27.08.26, CL VALLCALENT 32, 25006 LLEIDA, LLEIDA / **UNITEC**, 948/ 82.74.34, CL FUENTE CANONIGOS 5, 31500 TUDELA, NAVARRA / **TELSAN, C.B.**, 948/ 24.19.50, CL GAYARRE 1 BJOS., 31005 PAMPLONA, NAVARRA / **EURO TECNIC ELECTRONICA**, 977/ 32.24.89, CL LEPANTO 16-18, 43202 REUS, TARRAGONA / **ELECTRO SERVEI C.B.**, 977/ 51.04.42, PS MOREIRA 10, 43500 TORTOSA, TARRAGONA / **A.B.R. ELECTRONICA S.L.**, 977/ 50.21.20, CL CALDERON LA BARCA 3, 43520 ROQUETAS, TARRAGONA / **CURTO GAMUNDI S.R.C.**, 977/ 44.13.14, CL RIEROL CAPUTXINS 6, 43500 TORTOSA, TARRAGONA / **SELECCO S.L.**, 977/ 70.00.12, CL CALDERON DE LA BARCA 11, 43870 AMPOSTA, TARRAGONA / **ELECTRONICA S. TORRES**, 977/ 21.21.48, CL JOAN MIRO 4 ESC.D 1-2, 43005 TARRAGONA, TARRAGONA / **BUIRA TECNIC'S**, 977/ 66.04.37, CL SAN JAVIER 55, 43700 EL VENDRELL, TARRAGONA / **TECNO SERVEIS MORA**, 977/ 40.08.83, CL PAU PICASSO 1, 43740 MORA D'EBRE, TARRAGONA / **SERTECS, S.C.**, 977/ 22.18.51, CL CAPUTXINS (BAJOS) 22, 43001 TARRAGONA, TARRAGONA / **ELECTRONICA JOSEP**, 977/ 88.04.41, CTRA. IGUALADA 29 BJOS, 43420 STA. COLOMA QUERALT, TARRAGONA / **MARTORELL ALTES**, 977/ 75.32.41, CL ROSETA MAURI 10, 43205 REUS, TARRAGONA / **TELESERVICIO S.C.**, 978/ 87.08.10, CL ROMUALDO SOLER 4, 44600 ALCANIZ, TERUEL / **ELECTRONICA ALCANIZ S.L.**, 979/ 87.07.94, CL CARMEN 21, 44600 ALCANIZ, TERUEL / **SONOVISION, C.B.**, 978/ 60.11.74, CL ABADIA 5, 44001 TERUEL, TERUEL / **ELECTRONICA MONCHO**, 96/287.23.29, CL PARE PASCUAL CAT. 5, 46700 GANDIA, VALENCIA / **ENVISA ELECTRONIC, S.L.**, 96/241.24.87, CL GENERAL ESPARTERO 9, 46600 ALZIRA, VALENCIA / **ANTONIO MONLEON, S.L.**, 96/334.55.87, AV DE LA PLATA 91, 46006 VALENCIA, VALENCIA / **TECNO HOGAR**, 96/286.53.35, CL DOS DE MAYO 41, 46700 GANDIA, VALENCIA / **SERVICIOS ELECTRONICOS**, 96/340.20.34, CL DOCTOR OLORIZ 3, 46009 VALENCIA, VALENCIA / **ELECTRONICA LAS HERAS**, 96/ 238.11.14, CL JOSE IRANZO 6, 46870 ONTINYENT, VALENCIA / **NEGREDO MARTIN DANIEL**, 94/411.22.82, CL PADRE PERNET 8, 48004 BILBAO, VIZCAYA / **COLLANTES MARTIN ONOFRE**, 94/ 483.21.22, CL ORTUÑO DE ALANGO 7, 48920 PORTUGALETE, VIZCAYA / **ARGI GILTZ**, 94/ 443.77.93, CL AUTONOMIA 15, 48012 BILBAO, VIZCAYA / **SERVITELE**, 94/444.89.02, CL AUTONOMIA 24 Galerías, 48012 BILBAO, VIZCAYA / **CINCA MONTERDE ANTONIO**, 976/ 31.69.65, CL VIA UNIVERSITAT 52, 50010 ZARAGOZA, ZARAGOZA / **ARAGON TELEVIDEO, S.C.**, 976/ 32.97.12, CL BATALLA CLAVUJO 18, 50010 ZARAGOZA, ZARAGOZA / **TV VIDEO JIMENEZ, S.L.**, 967/ 34.04.43, CL JUAN XXIII 38, 02640 ALMANSA, ALBACETE / **JUMAN**, 967/ 22.40.78, CL EJERCITO 1, 02002 ALBACETE, ALBACETE / **TELEVIDEO**, 950/ 40.18.63, CL VELAZQUEZ 7 LOCALA, 04770 ADRA, ALMERIA / **SERVICIO TECNICO PONCE**, 950/ 45.67.53, UB MONTE ALMAGRO 10, 04610 CUEVAS DE ALMANZORA, ALMERIA / **SONIVITEL S.L.**, 950/ 22.97.55, CL POETA PACO AQUINO 51, 04005 ALMERIA, ALMERIA / **ELECTRONICA EDIMAR, S.A.**, 98/535.34.51, CL CANGAS DE ONIS 4, 33207 GIJON, ASTURIAS / **CAÑEDO S.T.**, 98/522.29.68, CL OTERO, S/N C. CIAL, 33008 OVIEDO, ASTURIAS / **ALVAREZ OLIVAR CASILDA**, 98/522.37.39, CL SAN JOSE 12, 33003 OVIEDO, ASTURIAS / **SANTIAGO VALDERREY**, 98/ 563.18.61, CL

• SERVICE NIEDERLASSUNGEN • ADDRESSES D'ENTRETIEN • ONDERHOUDSADRESSEN • DIRECCIONES DE SERVICIO • INDIRIZZI DI SERVIZIO •

DR. VENANCIO MTEZ. 7, 33710 NAVIA, ASTURIAS / **ASTUSETEL S.L.**, 98/539.10.11, CL CEA BERMUDEZ 9, 33208 GIJON, ASTURIAS / **ASTURSERVICE**, 98/556.83.87, CL SANCHEZ CALVO 6 bjos., 33401 AVILES, ASTURIAS / **JUAN MORILLON DEL CORRO**, 98/567.40.24, AV DE GIJON 19, 33930 LA FELGUERA/LANGREO, ASTURIAS / **S.A.T. JUAN-MANUEL**, 98/ 581.22.48, CL URIA 60, 33800 CANGAS DE NARCEA, ASTURIAS / **DANIEL SERRANO LABRADO**, 920/ 37.15.16, CL JOSE GOCHICOA 16, 05400 ARENAS DE S.PEDRO, AVILA / **ELECTRONICA GREDOS**, 920/ 22.48.39, CL EDUARDO MARQUINA 24, 05001 AVILA, AVILA / **JIMENEZ ALMOHALLA**, 920/ 25.08.76, CL JACINTO BENAVENTE 1, 05001 AVILA, AVILA / **ELECTRONICA BOTE**, 924/ 22.17.40, PZ PORTUGAL 2, 06001 BADAJOZ, BADAJOZ / **MARCIAL LAGOA GONZALEZ**, 924/ 49.03.33, CL RAMON Y CAJAL 7, 06100 OLIVENZA, BADAJOZ / **C.E. VILANOVENSE C.B.**, 924/ 84.59.92, CL CAMINO MAGACELA 4 LOCAL-5, 06700 VILLANUEVA SERENA, BADAJOZ / **ELECTRONICA CENTENO S.L.**, 924/ 57.53.08, AV DEL ZAFRA 1, 06310 PUEBLA SANCHO PEREZ, BADAJOZ / **INDALECIO AMAYA SANCHEZ**, 924/ 66.47.01, CL CARRERAS 11, 06200 ALMENDRALEJO, BADAJOZ / **PATRICIO ELECTRONICA**, 924/ 33.04.13, CL REYES HUERTAS 7, 06800 MERIDA, BADAJOZ / **ELECTRONICA MAS**, 947/ 31.49.94, CL ALFONSO VI 6, 09200 MIRANDA DE EBRO, BURGOS / **SERVITEC BURGOS S.L.**, 947/ 22.41.68, CL LAVADEROS 7-9, 09007 BURGOS, BURGOS / **RUIZ GARCIA JOSE**, 927/ 22.48.86, CL ECUADOR 5-B, 10005 CACERES, CACERES / **ARSENIO SANCHEZ, C.B.**, 927/ 41.11.21, CL TORNAVACAS 9, 10600 PLASENCIA, CACERES / **ZABALA VAZQUEZ JOSE**, 927/ 57.06.13, CL DEL AGUA 39, 10460 LOSAR DE LA VERA, CACERES / **RADIO SANCHEZ C.B.**, 927/ 32.06.88, AV DE MIAJADAS S/N, 10200 TRUJILLO, CACERES / **ELECTRONICA JEDA**, CL PAGADOR 31, 11500 PTO. STA. MARIA, CADIZ / **SERVICIO TECNICO**, 956/ 87.07.05, CL DIVINA PASTORA E-1 L-4, 11402 JEREZ LA FRONTERA, CADIZ / **JOSE BORJA Y JOSE ARANA**, 956/ 66.60.53, CL SAN ANTONIO 31, 11201 ALGECIRAS, CADIZ / **VHIFITEL**, 956/ 46.25.01, CL FCO.FDEZ.ORDOIEZ 5, 11600 UBRIQUE, CADIZ / **GALAN SAT S.L.**, 956/ 20.14.17, CL CRUZ ROJA ESPAÑOLA 11, 11009 CADIZ, CADIZ / **GALAN SAT S.L.**, 956/ 83.35.35, CL FACTORIA MATAGORDA 52, 11500 PUERTO REAL, CADIZ / **ELECTRONICA SEYMA**, 942/ 23.69.19, CL DEL MONTE 69 C bjos, 39006 SANTANDER, CANTABRIA / **TELE-NUOVA**, 926/ 50.59.96, CL CAMPO 56, 13700 TOMELLOSO, CIUDAD REAL / **ELECTRONICA ARELLANO**, 926/ 54.78.95, CL LORENZO RIVAS 14, 13600 ALCAZAR DE SAN JUAN, CIUDAD REAL / **ELECTRONICA LARA**, 926/ 21.17.87, CL DE LA JARA 1, 13002 CIUDAD REAL, CIUDAD REAL / **MANUEL VAZQUEZ**, 926/ 42.09.93, CL ADUANA 3, 13500 PUERTOLLANO, CIUDAD REAL / **ELECTRODIAZ S.L.**, 926/ 32.23.24, CL BUENSUCESO 10, 13300 VALDEPEÑAS, CIUDAD REAL / **DUEÑAS CAJAS TEODORO**, 957/ 26.35.06, CL HERMANO JUAN FDEZ 15, 14014 CORDOBA, CORDOBA / **ELECTRONICA SALES**, 957/ 66.09.04, CL ANDALUCIA 11, 14920 AGUILAR FRONTERA, CORDOBA / **LAIVISON ELECTRONICA S.L.**, 957/ 75.01.75, CM DE LA BARCA 3, 14010 CORDOBA, CORDOBA / **ANTONIO GONZALEZ**, 957/ 57.10.50, CL GRAL PRIMO RIVERA 61, 14200 PEÑARROYA, CORDOBA / **ELECTRONICA GARCIA**, 969/ 22.24.83, CL RAMON Y CAJAL 17, 16004 CUENCA, CUENCA / **GALLARDO ALONSO MIGUEL**, 958/ 67.64.81, CL CARMEN 104, 18510 BENALUA DE GUADIX, GRANADA / **VILCHEZ VILCHEZ RAFAEL**, 958/ 60.06.50, CL AMADEO VIVES 9, 18600 MOTRIL, GRANADA / **ELECTRONICA WENCESLAO**, 958/ 81.16.16, CL FONTIVEROS 42, 18008 GRANADA, GRANADA / **DIGIMAT ELECTRONICA**, 958/ 70.04.52, CL CASICAS 7, 18800 BAZA, GRANADA / **MEGATECNICA EXTREMERA**, 958/ 26.06.01, C/.MOZART L-2 Ed.Granate, 18004 GRANADA, GRANADA / **TECNICAS MARVI S.L.**, 949/ 23.27.63, PZ CAPITAN BOIXAREU 51, 19001 GUADALAJARA, GUADALAJARA / **ABRIL SANCHEZ VALENTIN**, 959/ 10.60.41, CL CADIZ 2, 21270 CALA, HUELVA / **TELESONID HUELVA, S.C.A.**, 959/ 24.38.60, CL FCO.VAZQUEZ LIMON 4, 21002 HUELVA, HUELVA / **ELECTRONICA SUR**, 959/ 47.11.51, CL M. LERDO DE TEJADA 9, 21400 AYAMONTE, HUELVA / **ELECTRO HIMEGA, S.A.**, 953/ 24.22.56, CL ADARVES BAJOS 4-C, 23001 JAEN, JAEN / **ELECTRONICA JUMAR**, 953/ 26.17.08, CL GOYA (LAS FLORES) 1, 23006 JAEN, JAEN / **ELECTRONICA GONZALEZ**, 953/ 50.33.82, CORREDERA SAN BARTOLOME 11, 23740 ANDUJAR, JAEN / **UNISERVIC ELECTRONICA**, 953/ 75.14.19, CL GOYA 1 BJS, 23400 UBEDA, JAEN / **NOMBRE1, TLFNO, CALLE, CIUDAD, PROVINCIA / ANUMA**, 953/ 69.70.41, CL PAREDON 24, 23700 LINARES, JAEN / **TALLERES INSTALUZ**, 981/ 26.80.26, CL JUAN FLOREZ 110, 15005 LA CORUÑA, LA CORUÑA / **GARCIA QUINTELA ARTURO**, 981/ 70.21.07, CL XOANE, 15100 CARBALLO, LA CORUÑA / **MANUEL MATO SEÑARIS**, 981/ 53.71.14, CL SILVOUTA-PEDRA DA, 15896 SANTIAGO COMPOSTELA, LA CORUÑA / **ZENER ELECTRONICA**, 981/ 22.07.00, CL RONDA DE MONTE ALTO 15, 15002 LA CORUÑA, LA CORUÑA / **S.T. MENDEZ**, 981/ 27.52.52, CL GIL VICENTE 13, 15011 LA CORUÑA, LA CORUÑA / **ELECTRONICA CASTILLA**, 981/ 32.14.09, CR CASTILLA 377-bis bjos, 15404 FERROL, LA CORUÑA / **BANDIN AUDIO**, 981/ 86.60.23, CL RUA ARCOS MOLDES 2 B-3, 15920 RIANXO, LA CORUÑA / **ELECTRONICA TORRES, S.C.**, 941/ 24.76.15, AV NAVARRA 14, 26001 LOGROÑO, LA RIOJA / **TOP SERVICE**, 941/ 13.50.35, CL ACHUTEGUI DE BLAS 17, 26500 CALAHORRA, LA RIOJA / **AGUADO GIL ROBERTO**, 941/ 25.25.53, AV VIANA 10, 26001 LOGROÑO, LA RIOJA / **TELSON**, 987/ 21.25.18, CL BATALLA CLAVIJO 2, 24006 LEON, LEON / **SALVADOR RODRIGUEZ, C.B.**, 987/ 40.36.02, CL ORTEGA Y GASSET 24, 24400 PONFERRADA, LEON / **PROSAT**, 987/ 20.34.10, PZ DOCE MARTIRES 5, 24004 LEON, LEON / **ELECTRONICA FOUCES**, 982/ 40.24.38, CL BENITO VICETTO 34, 27400 MONFORTE DE LEMOS, LUGO / **TELEVEXO S.L.**, 982/58.18.57, CL NOSA SRA. do CARMEN 82, 27880 BURELA, LUGO / **ELECTRONICA PENELO**, 982/ 21.47.43, CL SERRA GA#IDOIRA 63, 27004 LUGO, LUGO / **GOMESCAN**, 91/305.48.90, PZ DEL JUBILADO 8, 28042 BARAJAS-MADRID, MADRID / **ELECTRONICA GARMAN, C.B.**, 91/368.01.79, CL MANDARINA 15, 28027 MADRID, MADRID / **ELECTRONICA ANSAR**, 91/ 460.47.45, CL TOMASA RUIZ 4, 28019 MADRID, MADRID / **TEC-NORTE**, 91/851.63.47, CL SANTIAGO

· SERVICE NIEDERLASSUNGEN · ADDRESSES D'ENTRETIEN · ONDERHOUDSADRESSEN · DIRECCIONES DE SERVICIO · INDIRIZZI DI SERVIZIO ·

APOSTOL 12, 28400 COLLADO VILLALBA, MADRID / **VARIOSAT, S.L.**, 91/662.04.68, CL ISLA DE CORCEGA 24, 28100 ALCOBENDAS, MADRID / **ELBESERVI, S.A.**, 91/386.27.11, CL DR.R. CASTROVIEJO 19, 28029 MADRID, MADRID / **ALCALA SERVITEC C.B.**, 91/889.00.32, CL SANTA URSULA 5, 28801 ALCALA DE HENARES, MADRID / **GARMAN C.B.**, CL CARLOS SOLE 38 local, 28038 MADRID, MADRID / **AVILES SANCHEZ ANTONIO**, 952/ 36.16.02, CL CIUDAD DE ANDUJAR 2, 29006 MALAGA, MALAGA / **VIDEO TALLER, S.C.**, 952/ 54.23.95, EDIF. LA NORIA B BJOS-5, 29740 TORRE DEL MAR, MALAGA / **SERVISUEL, EDIF. LA UNION**, 952/ 46.90.28, CM DE LAS CA#ADAS LC 2, 29640 FUENGIROLA, MALAGA / **BISER, S.L.**, 952/ 25.55.53, CL LOZANO DE TORRES 8, 29013 MALAGA, MALAGA / **ELECTRO RONDA**, 952/ 87.59.99, CL SANTA CECILIA 11, 29400 RONDA, MALAGA / **DIEGO LOPEZ JODAR**, 95/ 280.12.23, PZ DEL RELOJ 13, 29680 ESTEPONA, MALAGA / **CARO PORLAN RAIMUNDO**, 968/ 46.18.11, CL JOSE MOULIAA 45, 30800 LORCA, MURCIA / **REG., C.B.**, 968/ 51.00.06, CL ANTONIO OLIVER 17, 30204 CARTAGENA, MURCIA / **ELECTROSERVICIOS SEBA, C.B.**, 968/ 29.85.93, CL ISAAC ALBENIZ 4 BJOS, 30009 MURCIA, MURCIA / **VISATEL**, 968/24.16.47, CL TORRE ALVAREZ S/N, 30007 MURCIA, MURCIA / **ELECTRO SERVICIOS PLAZA,**, 968/ 28.45.67, CL GOMEZ CORTINA 10, 30005 MURCIA, MURCIA / **RAFAEL GOMEZ YELO**, 968/ 26.14.67, PS CORBERA 17, 30002 MURCIA, MURCIA / **FERNANDEZ GONZALEZ JOSE**, 988/ 23.48.53, AV BUENOS AIRES 75 BJOS, 32004 ORENSE, ORENSE / **ELECTRONICA JAVIER**, 979/ 75.03.74, CL RAMIREZ 5, 34005 PALENCIA, PALENCIA / **CENTRAL DE SERVICIOS**, 986/ 37.47.45, CL ASTURIAS (BAJO) 10, 36206 VIGO, PONTEVEDRA / **MONTAJES SERVICIOS TECN.**, 986/ 84.16.36, CL LOUREIRO CRESPO 43, 36004 PONTEVEDRA, PONTEVEDRA / **SIAL-ALVIMO S.L.**, 986/ 29.93.01, C/ C.TORRECEDEIRA 92 bjos, 36202 VIGO, PONTEVEDRA / **ELECTRONICA CAMBADOS**, 986/ 50.83.27, CL CAMILO JOSE CELA 13, 36600 VILAGARCIA AROUSA, PONTEVEDRA / **ALMAT ELECTRONICA**, 923/ 22.45.08, CL GALILEO 21, 37004 SALAMANCA, SALAMANCA / **GUIJO S.T.**, 921/ 42.94.18, CL RAMON Y CAJAL 1, 40002 SEGOVIA, SEGOVIA / **AVITELSAT, S.A.**, 954/ 66.21.52, CL ESPINOSA Y CARCEL 31, 41005 SEVILLA, SEVILLA / **VANHCOLOR, S.L.**, 95/433.83.03, CL SAN JACINTO 96, 41010 SEVILLA, SEVILLA / **TELEPAL**, 95/464.95.80, CL JULIO VERNE 49, 41006 SEVILLA, SEVILLA / **AUVITEL, S.L.**, 95/427.57.07, CL VIRGEN DE AFRICA 20, 41011 SEVILLA, SEVILLA / **AUDIO COLOR**, 95/457.94.47, CL GOLGOTA 3 LOCALIZDA., 41003 SEVILLA, SEVILLA / **ELECTRO 93 S.L.**, 95/ 472.37.16, CL MELLIZA 1, 41700 DOS HERMANAS, SEVILLA / **TECO**, 975/ 22.61.25, CL ANTOLIN DE SORIA 10, 42003 SORIA, SORIA / **ELECTRONICA RIVAS**, 925/ 80.55.46, CL BARRIO SAN JUAN 1, 45600 TALAVERA LA REINA, TOLEDO / **ELECTRONICA FE-CAR, S.L.**, 925/ 21.21.45, AV SANTA BARBARA 30, 45006 TOLEDO, TOLEDO / **ELECTRONICA JOPAL S.L.**, 925/ 25.04.42, AV SANTA BARBARA S/N, 45006 TOLEDO, TOLEDO / **ELECTRO ANAYA**, 925/ 48.09.81, CL VERTEDEIRA ALTA 14, 45700 CONSUEGRA, TOLEDO / **TELESERVICIOS**, 983/ 30.92.61, CL ESGUEVA 6, 47003 VALLADOLID, VALLADOLID / **ASIST. TECNICA MARCOS**, 983/ 29.78.66, CL PIO DEL RIO HORTEGA 2-4, 47014 VALLADOLID, VALLADOLID / **ELECTRONICA VITELSON**, 983/ 80.43.56, PZ DEL MERCADO 9, 47400 MEDINA DEL CAMPO, VALLADOLID / **R.T.V. BLANCO**, 980/ 51.14.41, CL EDUARDO JULIAN PEREZ 9, 49018 ZAMORA, ZAMORA

SWITZERLAND

FALCOMAT AG, Allmendstrasse 134, 4058 BASEL. Tel. 061601-1919. Fax. 061601-5755

SWEDEN

Vid förfrågningar angående din mikrovågsugn var vänlig kontakta din återförsäljare eller någon av Sharps representanter **Centralservice Umeå**, Formvägen 8, 90621 Umeå, Phone: 090-125001, Fax: 090-131135 / **Bild o ljudservice**, Roxviksgalen 8, 582 73 Linköping, Phone: 013-356250, Fax: 013-356255 / **Jönköpings Antenn & TV Service**, Fridhemsvägen 20, 553 02 Jönköping, Phone: 036-161690, Fax: 036-160211 / **Ratronik Radio & TV Service**, Nordlandergatan 15, 931 32 Skellefteå, Phone: 0910-17305, Fax: 0910-16844 / **Tomi Elektronik AB**, Bäckvägen 90, 126 47 Hägersten, Phone: 08-186170, Fax: 08-186175 / **Tretronik**, Östermovägen 33, 854 62 Sundsvall, Phone: 060-155925, Fax: 060-173690 / **TV-Trim Service AB**, S:T Pauligatan 37, 416 60 Göteborg, Phone: 031-847200, Fax: 031-847500

NORWAY

Norsk Elektronik senter, Postbox 13, No-2007 Kjeller, Phone: +47-63804500, Fax: +47-63804501

ICELAND

Braedurnir Ormsson Ltd, PO box 8790, IS-128 Reykjavik, Phone: +354-5332800, Fax: +354-5332810
Hjólmtækni Ehf, Skeifar, IS-108 Reykjavik, Phone: +354-5332150, Fax: +354-5332151

DENMARK

Almstock Radio & Tv service, Sallingsvej 61, DK-2720 Vanløse, Phone: 45-38740021, Fax: 45-38740031

SUOMI

Oy Perkho, PL 40 Rälssintie 6, SF-00721 Helsinki, Phone: +35-8947805000, Fax: +35-8947805480
Theho Video, Kuoataankatu 7, SF-00520 Helsinki, Phone: +35-891451500, Fax: +35-891461767

SHARP

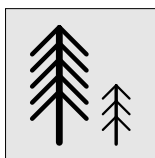

*Der Zellstoff zur
Herstellung dieses
Papiers kommt zu
100 % aus nachhaltig
bewirtschafteten
Wäldern*

*Ce papier est
entièrement fabriqué
à partir de pâte à
papier provenant
de forêts durables*

*De pulp die gebruik is
voor de vervaardiging
van dit papier is voor
100 % afkomstig uit
bossen die doorlopend
opnieuw aangepland
worden*

*Il 100 % della pasta
utilizzata per
produrre questa carta
proviene da foreste
sostenibili*

*El 100 % de la
pasta utilizada en
la fabricación de
este papel procede
de bosques
sostenibles*

SHARP ELECTRONICS (EUROPE) GMBH.
Sonninstrasse 3, 20097 Hamburg
Germany

TINS-A310URRO

Gedruckt in Grossbritannien
Imprimé au Royaume-Uni
Gedruckt in Groot-Brittannie
Stampato in Gran Bretagna
Impreso en el Reino Unido

SHARP



*Das Papier dieser
Bedienungsanleitung
besteht zu 100 %
aus Altpapier*

*Le papier de ce
mode d'emploi est
fait de 100 %
de papier réutilisé*

*De papier voor deze
gebruiksaanwijzing
is van 100 %
hergebruiken papier
gemaakt*

*La carta di questo
manuale d'istruzioni
è fatta di 100 %
della carta riciclata*

*El papel de este
manual de
instrucciones se
hace de 100 %
es del papel
reciclado*

SHARP ELECTRONICS (EUROPE) GMBH.
Sonninstrasse 3, 20097 Hamburg
Germany

TINS-A310URRO

Gedruckt in Grossbritannien
Imprimé au Royaume-Uni
Gedruckt in Groot-Brittannië
Stampato in Gran Bretagna
Impreso en el Reino Unido