

30DSERIES

turbofan[®]

E31D4
(Digital Operation)

Installation and Operation Manual

turbofan
CONVECTION OVEN SYSTEMS

MOFFAT[®]

BLUE SEAL[®]

MANUFACTURED BY

Moffat Limited

Christchurch
New Zealand

INTERNATIONAL CONTACTS

AUSTRALIA

Moffat Pty Limited

E.Mail: vsales@moffat.com.au
Main Office: (tel) (03) 9518 3888
(fax) (03) 9518 3833
Service: (tel): 1800 622 216
Spares: (tel): 1800 337 963
Customer Service: (tel): 1800 335 315
(fax): 1800 350 281

CANADA

Serve Canada

Web: www.servecanada.com
E.Mail: info@servecanada.com
Sales: (tel): 800 551 8795 (Toll Free)
Service: (tel): 800 263 1455 (Toll Free)

NEW ZEALAND

Moffat Limited

Web: www.moffat.co.nz
E.Mail: sales@moffat.co.nz
Main Office: (tel): 0800 663328

UNITED KINGDOM

Blue Seal

Web: www.blue-seal.co.uk
E.Mail: sales@blue-seal.co.uk
Sales: (tel): 0121 327 5575
(fax): 0121 327 9711
Spares: (tel): 0121 322 6640
(fax): 0121 327 9201
Service: (tel): 0121 322 6644
(fax): 0121 327 6257

UNITED STATES

Moffat

Web: www.moffat.com
Sales: (tel): 800 551 8795 (Toll Free)
(tel): 336 661 1556
(fax): 336 661 9546
Service: (tel): 800 858 4477 (Toll Free)
(tel): 366 661 1556
(fax): 336 661 1660

REST OF WORLD

Moffat Limited

Web: www.moffat.co.nz
E.Mail: export@moffat.co.nz

The reproduction or copying of any part of this manual by any means whatsoever is strictly forbidden unless authorized previously in writing by the manufacturer.

In line with policy to continually develop and improve its products, Moffat Ltd. reserves the right to change the specifications and design without prior notice.

Contents List

E31 Turbofan Convection Oven.

Model Numbers Covered in this Manual

E31D4 - Turbofan Oven - 4 Tray Convection Oven.

Introduction	2
Safety Information	
Specifications	3
Installation	4
Installation Requirements	
Unpacking	
Location	
Clearances	
Stand Mounted Ovens	
Electrical Connection	
Positioning and Levelling of Oven	
Initial Start-Up	
Operation	7
Operation Guide	
Oven Control Panel	
Using the Oven - Manual Mode	
Cooking in Program Mode	
Setting the Oven Programs	
Operator Accessible Parameters	11
Setting the Operator Accessible Parameters	
Table of Operator Accessible Parameters	
Cleaning	12
Cleaning Guidelines	
Oven Cleaning	
Fault Finding	14
Electrical Schematics	15
Replacement Parts List	16

Introduction

Before using your new oven, please read this instruction manual carefully, pay particular attention to any information labelled '**WARNING**', '**CAUTION**', '**IMPORTANT**' or '**NOTE**' in this manual.



Warning

Indicates a hazardous situation which, if not avoided, will result in death or serious injury.



Caution

Indicates a hazardous situation which, if not avoided, will result in minor or moderate injury.

If you are unsure of any aspect of the installation, instructions or performance of your oven, contact your TURBOFAN dealer promptly. In many cases a phone call could answer your question.

Should you contact your TURBOFAN dealer on any matter concerning this oven, please have the information provided opposite, readily available.

This manual must be kept by the owner for future reference.

A record of the **Date of Purchase**, **Date of Installation** and **Serial Number of the oven** should be recorded in the area provided below.

The serial number of this oven can be found on the Technical Data Plate located on the front right hand side panel, see diagram in 'Installation Section'.

Model Number:

Serial Number:

Dealer:

Service Provider:

Date Purchased:

Date Installed:

Safety Information

For your safety, please pay attention to the following symbols marked on the appliance.

- Risk of electric shock.



No user serviceable parts inside.

Qualified service person access only.

Disconnect from power before servicing.

Specifications

E31D4

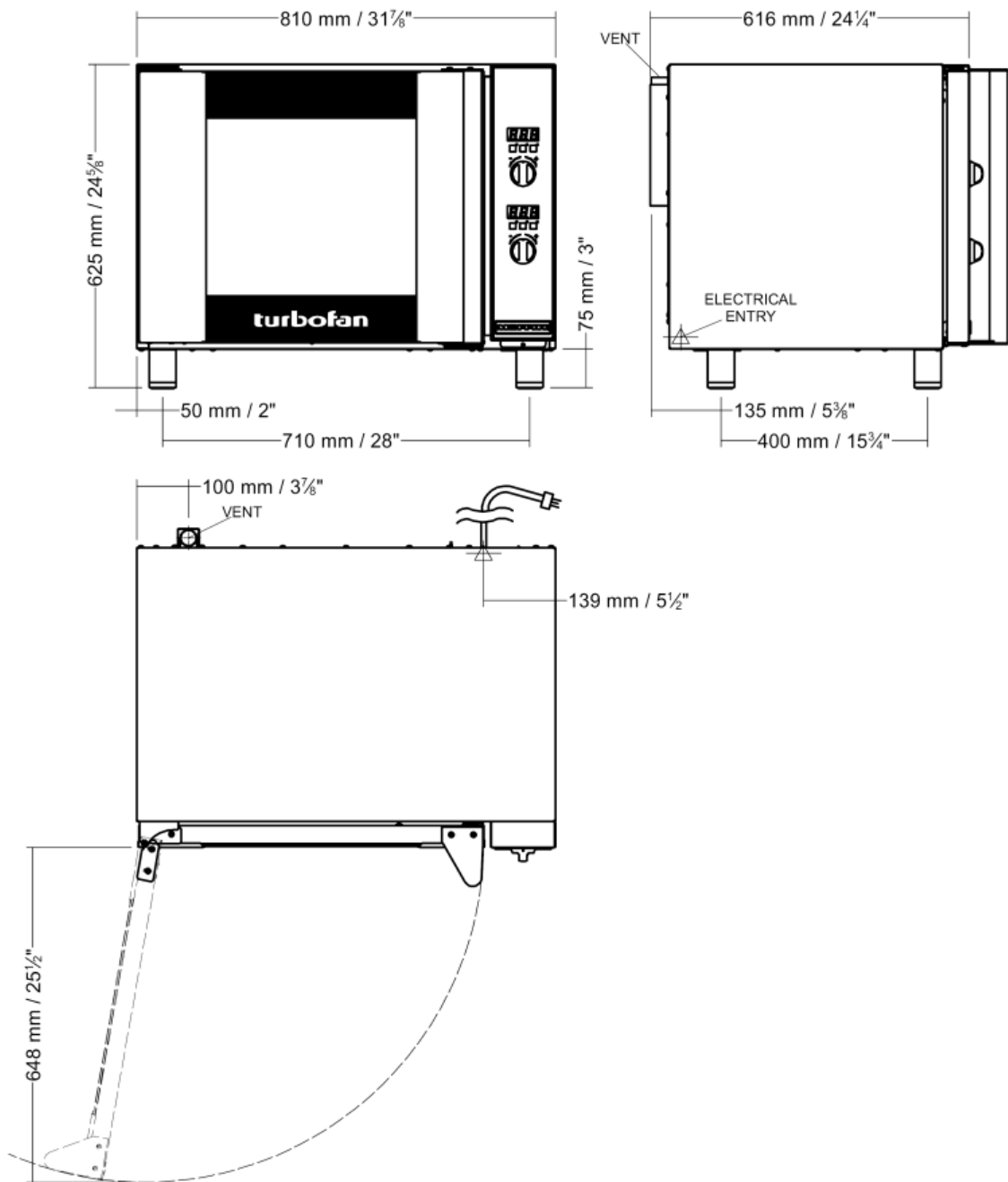

Oven Power Ratings				Oven Tray Details	
				Tray Capacity	Tray Spacing
208V,	1P+N+E,	50/60HZ,	2.9 kW	4 x GN 1/1 Pan 4 x US 1/2 Pan	85 mm / 3 ¹ / ₃ "
220V,	1P+N+E,	50/60HZ,	3.1 kW		
230-240V,	1P+N+E,	50/60HZ,	3.1 kW		

Installation

Installation Requirements

Important:

- Installation shall comply with local electrical, health and safety requirements.
- It is most important that this oven is installed correctly and that oven operation is correct before use.
- If you have any questions regarding the proper installation and / or operation of this oven, please contact your local Turbofan distributor.

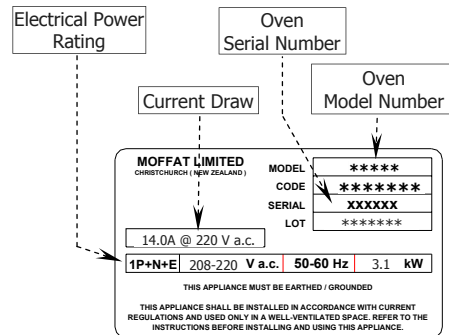

Technical Data Plate - Data and Location (example only)

Unpacking

1. Remove all packaging and transit protection including all protective plastic coating from the exterior stainless steel panels.
2. Check the oven and supplied parts for damage. Report any damage immediately to the carrier and distributor.
3. Check that the following parts have been supplied with your oven:-
 - 4 x Leg Adjustable.
4. Report any deficiencies to the distributor who supplied your oven.
5. Securely fit the 4 legs supplied with the oven.
6. Check that the available electrical supply is correct to that shown on the Technical Data Plate located on the front right hand side panel.

- Refer to 'Specifications' section, 'Oven Specifications Tables'.

Location

1. Position the oven in its approximate working position.
2. The unit should be positioned so that the control panel and oven shelves are easily reachable for loading and unloading.

Clearances

To ensure correct ventilation for the motor and controls, the following minimum installation clearances are to be adhered to:-

Top	200 mm / 8".
Rear	75 mm / 3".
Left-hand side	75 mm / 3".
Right-hand side	75 mm / 3".

Important:

The vent located at the rear of the oven must NOT be obstructed.

Oven Vent Location



Stand Mounted Ovens

For ovens that are to be mounted to a stand, the oven feet are used to level the oven on the stand. Refer to the instructions supplied with separately ordered stands for mounting details.

Installation

Electrical Connection



Warning

This oven must be earthed / grounded.

If the supply cord is damaged, it must be replaced by a suitably qualified person in order to avoid a hazard.

Each oven should be connected to an adequately protected power supply and an isolation switch mounted adjacent to, but not behind the oven and must be readily accessible to the operator. This switch must be clearly marked and readily accessible in case of fire.

Check the electricity supply is correct to as shown on the Technical Data Plate on the front right hand corner of the oven side panel.

Ensure that the oven is fitted with the appropriate power cord and plug.

Positioning and Levelling of Oven

1. Correctly locate the oven into its final operating position and using a spirit level, adjust the oven feet so that the oven is level and at the correct height.

Initial Start-Up

Before using the new oven;

1. For first time use of the oven, operate the oven for about 1 hour at 200°C / 400°F to remove any fumes or odours which may be present.
2. Please refer to the Operation Section of this manual for details on how to correctly operate and shutdown the oven.

Commissioning

Before leaving the new installation;

Check the oven functions in accordance with the operating instructions specified in the 'Operation' section of this manual.

Ensure that the operator has been instructed in the areas of correct operation and shutdown procedure for the appliance.

NOTE: If for some reason it is not possible to get the appliance to operate correctly, turn off the power supply at the mains supply and contact the supplier of this appliance.

Reversing the Oven Door

NOTE: This operation should only be carried out by a suitably competent person.

Remove the Oven Door Inner Glass.

1. Open the oven door and open the door inner glass.
2. Remove the screw securing the inner glass retaining clip and remove the clip.
3. Lift up the inner glass and remove, ensuring that the pivot spacer is removed from the lower inner glass pivot and retained.

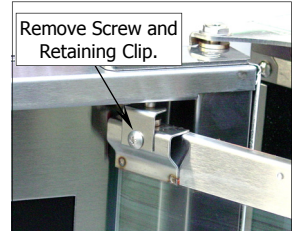

4. Remove the black plastic plugs from the top and bottom of the door and fit to the holes where the inner glass pivots were removed from.

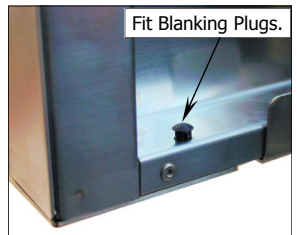

Remove the Oven Door.

5. Remove the door roller catch and blanking plate from the inside of the door and swap these over.

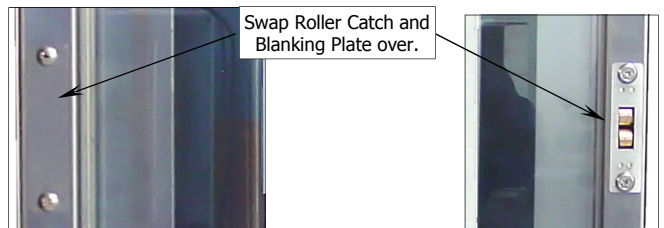

6. Whilst supporting the door, unscrew and remove the top door pivot bolt from the top door hinge assembly.
7. Remove the door and lay on a flat surface or workbench.

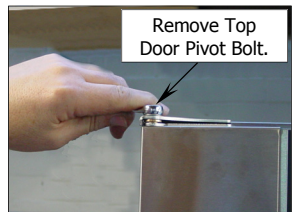

8. Unscrew the screws securing the door handle and remove the door handle.



9. Remove the top door hinge and fit to the bottom opposite corner of the door.
10. Remove the bottom door hinge and fit to the top opposite corner of the door.

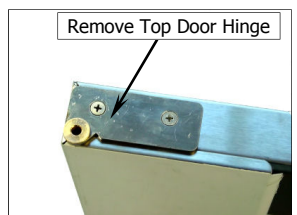

Installation

- Remove the inner glass latching studs and fit to opposite side of door using Loctite 243 to secure.

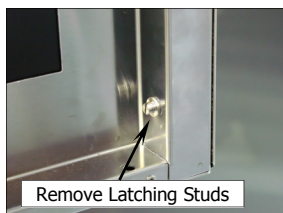

- Turn the door handle over and fit to the other end of the door where the hinges were removed from. Ensure Flat of handle is to the outside.

Remove the Upper and Lower Door Hinges and Door Catch.

- Remove the bottom door pivot bolt and spacers and fit the pivot bolt to the top door hinge assembly (as this will be swapped over and fitted to the bottom of the other side of the oven).

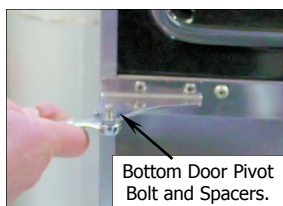

- Remove the 4 blanking screws from the front of the oven.



- Remove the Hinge Plate from the top of the oven and fit diagonally opposite, to the lower corner.



- Remove the Hinge Plate from the bottom of the oven and fit diagonally opposite, to the upper corner.

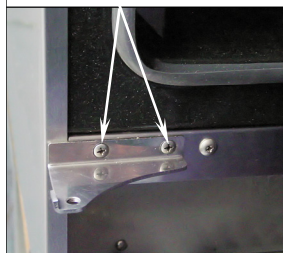

- Fit the screws removed at Item 14 above to where the hinges were fitted.

- Remove the Blanking Screw and Door Catch from the front of the oven and swap around.

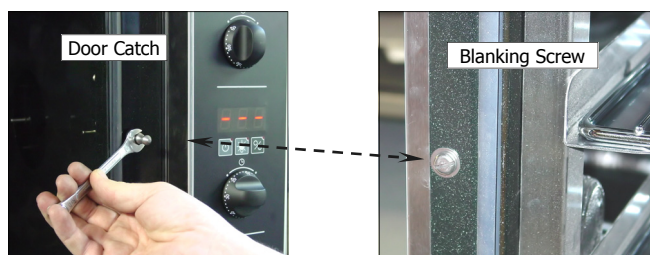

- Fit the door spacers removed at Item 13 opposite to the lower hinge pivot bolt.

Oven Door Re-Fitting

Fit the Door.

- Refit the oven door by locating the bottom of the door onto the bottom hinge plate pivot bolt and spacers.
- Fit the top of the door into the top hinge plate and secure with the top pivot bolt.

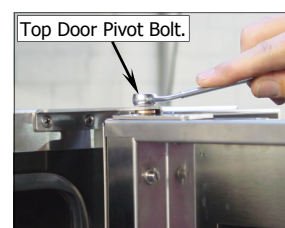

Fit Inner Glass to Door.

NOTE: It is important to ensure that the inner glass is fitted correctly and that the glass pivots at the hinge end of the door and not the handle end.

- Fit the pivot spacer removed at Item 3 on the previous page, to the lower inner glass pivot and locate the inner glass lower pivot into position on the inside of the door.
- Locate the top pivot of the inner glass into the top of the door and secure in position with the inner glass retaining clip.



- Lift the inner glass up onto the locking catch to lock into position.



Adjust the Door for Correct Alignment.

Check the operation of the door. Ensure that the door roller catch correctly retains the door in the closed position.

To adjust, slightly loosen the screws securing the roller catch and close the door. The roller catch will centralise itself. Open the door and tighten the roller catch securing screws.

Operation

Operation Guide



Warning

Some parts of this oven will become **VERY HOT** during use and could cause burns if touched.



Warning

Take care when opening the oven door during baking. Let hot air and steam escape before removing or replacing food as the steam produced can cause steam burns.

- Turbofan Ovens have been designed to provide simple operation.
- This oven is intended for use in a commercial kitchen and must only be put to the use for which it was intended, i.e. cooking food product. To use this oven correctly please read the following sections carefully:-

Oven Control Panel

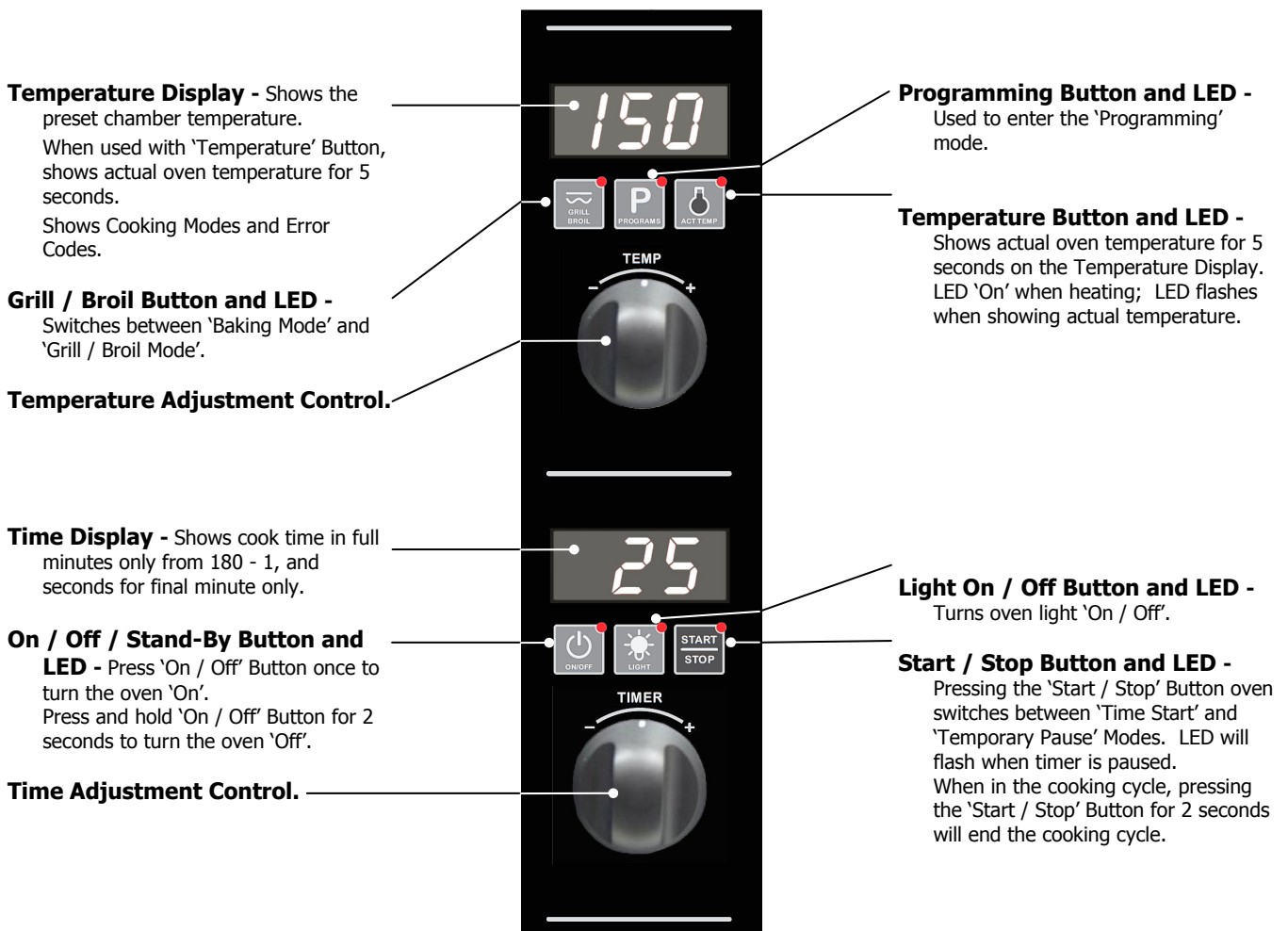

Starting the Oven

1. Turn 'On' electrical power to the oven. The controller will carry out a self check of the LED's.
2. Press the 'On/Off' Button.
3. The Heating Indicator will illuminate.

Oven Shut-Down

1. To turn 'Off' the oven, press and hold the 'On/Off' button for 3 seconds, the oven controller will go to 'Stand-By' mode.

Operation

Using the Oven - Manual Mode

1. TURN 'ON'.

Press 'On-Off' button.



Temperature Display.

Temperature Display will show actual temperature.

150

To check actual oven temperature during preheat or cooking, press 'Temperature' button. Actual temperature will display briefly on 'Temperature Display' before the display reverts to the pre-set temperature.

Heating 'On' Indicator

2. SET TEMPERATURE.

- + to increase the temperature.
- to decrease the temperature.

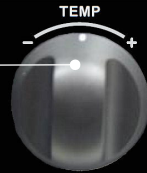

At any time during cooking, time and temperature can be adjusted by using the 'Time' / 'Temperature' controls.

Time Display.

Time Display will show actual time set.

25

Timer 'On' Indicator

Power 'On' Indicator

3. SET TIME.

- + to increase the time.
- to decrease the time.



This oven can be used without using the 'Timer', as it is purely a timer and does not control the baking operation of the oven.

4. START TIMER.

Press 'Start / Stop' button to start timer operation.

If the 'Timer' is set to the 'Infinity' setting **inf**, the timer will count elapsed time to a maximum of 999 minutes.

Opening the oven door during a cooking cycle will pause the cooking time. To continue cooking, close the oven door.

- Press any button, to cancel the 'Alarm'.



- Press 'Grill / Broil' button, to select the Grill / Broil mode.



- Press 'Act Temp' button, to check 'Actual' temperature of oven at any time during cooking.



- Press 'Light' button, to turn 'On' oven light. (refer - 'Operator Accessible Parameters').



- Press 'Program' button, to program the Oven refer to the 'Installation and Operation Manual'.



- Press and hold 'On / Off' button, for 3 seconds to turn 'Off' the Oven.

Grill / Broil; - Grill / Broil function can be selected at any time during the Manual Mode by pressing the 'Grill / Broil' button. The 'Grill / Broil' LED will illuminate.

The Time Display will show either 'Grill' **grL** or 'Broil' **brL**.

On completion of the Grill / Broil mode, the oven temperature will return to the temperature previously set.

Operation

Cooking in Program Mode

1. TURN 'ON'.

Press 'On-Off' button.



Press 'Programs' button.



Temperature Display.

Temperature Display will show program selected.

2. SELECT A PROGRAM.

+ to scroll forward through programs.
- to scroll backward through programs.

Time Display.

Time Display will show 'Pre-Heating'.
Program cannot be started until pre-heating is completed.

Load Oven.

'Time' display will show 'Ready'.



3. START PROGRAM.

Press 'Start / Stop' button to start cooking program.



Program Mode Indicator

Heating 'On' Indicator

To check actual oven temperature during preheat or cooking, press 'Temperature' button. Actual temperature will display briefly on 'Temperature Display' before the display reverts to the pre-set temperature.

When cooking in 'Program' mode, the oven light will remain 'On' until cooking is completed.

Opening the oven door during a cooking cycle will pause the cooking time. To continue cooking, close the oven door.

- **Press any button**, to cancel the 'Alarm'.



- **Press 'Grill / Broil' button**, to select the Grill / Broil mode.



- **Press 'Act Temp' button**, to check 'Actual' temperature of oven at any time during cooking.



- **Press 'Program' button**, to program the Oven refer to 'Setting the Oven Programs' overleaf.



- **Press and hold 'On / Off' button**, for 3 seconds to turn 'Off' the Oven.

Grill / Broil; - Grill / Broil function can be selected at any time during the Program Mode by pressing the 'Grill / Broil' button. The 'Grill / Broil' LED will illuminate.

The Time Display will show either 'Grill' **grL** or 'Broil' **brL**.

On completion of the Grill / Broil mode, the oven temperature will return to the temperature previously set.

Operation

Setting the Oven Programs

Oven can be pre-programmed with up to 20 Program's. When you receive your oven, the controller is not programmed. To set programs, carry out the following for each program required:-

1. ENTER PROGRAMMING MODE.

Press 'Programs' button to enter 'Programming' mode.



2. SELECT PROGRAM REQUIRED.

Rotate 'Temperature Control' to program required.
Temperature Display will show program selected.

Press and hold 'Temperature' button until 'Time' and 'Temperature' displays and 'Temperature' button LED flashes.



Change time and temperature parameters.

3. ENTER COOK TEMPERATURE.

Rotate 'Temperature Control' to set cook temperature.
+ to increase the temperature.
- to decrease the temperature.

'Temperature' Display will show temperature selected.



4. ENTER COOK TIME.

Rotate 'Timer Control' to set cook time.
+ to increase the time.
- to decrease the time.

'Time' Display will show time selected.



'Time' and 'Temperature' displays and 'Temperature' button LED flash.



Press 'Temperature' button to confirm 'Time' and 'Temperature' settings.

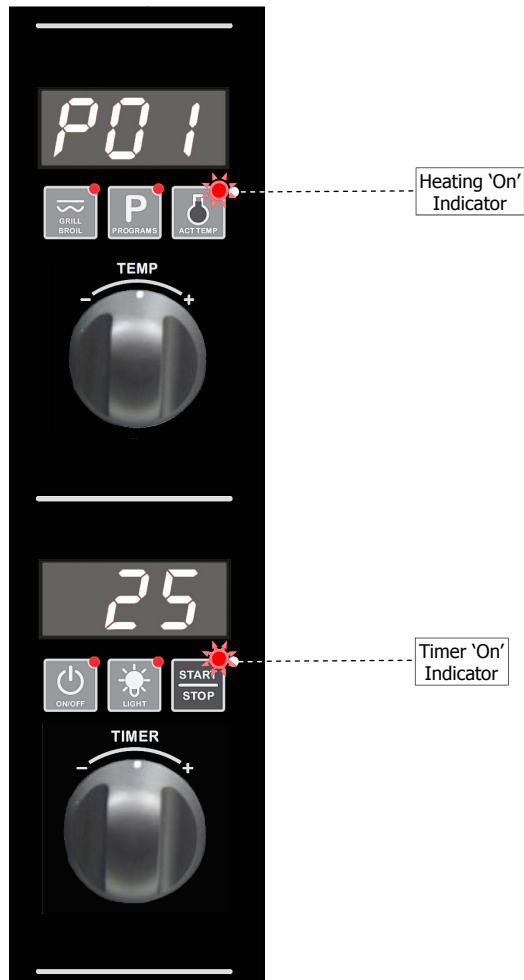

Operator Accessible Parameters

Setting the Operator Accessible Parameters

1. ENTER THE OPERATOR PARAMETER MODE.

Press 'Grill / Broil' and 'Start / Stop' buttons together.

'Temperature' Display will show 'PAS'.

The 'Time' Display will flash.



2. SET PASSWORD.

Rotate 'Timer Control' to set password;
(123) (Operator Password).

Press 'Light On / Off' button to confirm password.

'Temperature' Display will show one of Parameter Codes.

'Time' Display will show value of the parameter.



3. SETTING THE PARAMETERS.

Rotate 'Timer Control' to parameter required.

Press 'Light' button to confirm parameter. 'Time' display will flash.

While 'Time' display is flashing, rotate 'Timer Control' to select value required.

Press 'Light' button to confirm value. 'Time' display will stop flashing.



4. EXITING THE PARAMETER MODE.

Press 'On-Off' button, to return to 'Stand-By' mode.



Table of Operator Accessible Parameters

Parameter Number.	Description	Default Setting
	Turn -On Pre-Heating Temperature. (60 - 260°C / 140 - 500°F).	150
	Light Auto 'Off' Setting Time - 0 = 'On/Off'. 1 = 1 minute auto 'Off'. 2 = 2 minutes auto 'Off', etc.	1
	Buzzer Volume - Can be adjusted from '0' to '10'.	5
	Program Pre-Heating Condition - (Can be adjusted from 0 to 30 degrees above pre-heat temperature).	10

Cleaning

Cleaning Guidelines



Caution

Always turn off electrical power at the mains supply before commencing cleaning.

This oven is not water proof. Do not use water jet spray to clean interior or exterior of the appliance.

To achieve the best results, cleaning must be regular and thorough. If any small faults occur, have them looked at promptly. Don't wait until they cause a complete breakdown.

NOTE:

- Carefully read and follow the safety instructions on the label of the cleaning product to be used.
- **DO NOT** use harsh abrasive scouring pads or abrasive detergents as they could damage the oven.
- Ensure that any detergent or cleaning material has been completely removed after each cleaning.

To keep your oven clean and operating at peak efficiency, follow the procedures shown below:-

Oven Cleaning

NOTE:

- If the oven usage is very high, the cleaning procedure should be carried out on a more frequent basis.
- Allow the oven interior to cool to approx 50°C - 120°F before commencing cleaning.

Stainless Steel Surfaces

- Thoroughly clean the exterior surfaces of the oven with, a damp cloth moistened with a mild detergent solution, or a soft bristled brush.
- Baked on deposits or discolouration may require a good quality stainless steel cleaner. Always apply cleaner when the oven is cold and rub in the direction of the grain.

Side Racks

- Remove wire oven racks and bottom element guard.
- Partially undo the rack securing screw (anti-clockwise) securing side rack to the oven wall, until the rack is loose.

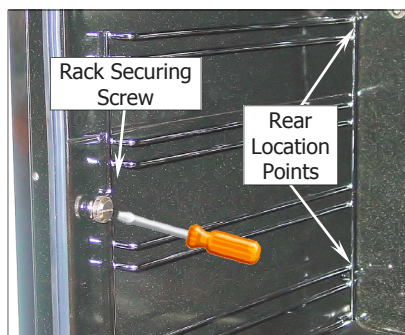

- Pull side racks forward to disengage the location pins at the rear of rack from the rear wall of the oven and remove the racks from the oven.
- Clean all racks with a mild anti bacterial detergent and hot water, using a soft bristled brush.
- Dry the racks thoroughly with a dry cloth.
- To refit the racks, engage the locating pins at the rear of side rack into the locating holes in the rear of the oven.
- At the same time locate the front of the rack over the rack securing screw and hand tighten the rack securing screw .
- Refit the wire oven racks and bottom element guard to the oven.

Lamp Glass / Fan Baffle

- Remove the wire racks as shown previously.

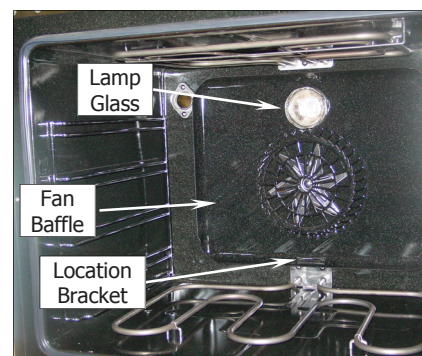

- Whilst holding the fan baffle in place, undo the lamp glass (anti-clockwise) and remove.



- Pull the fan baffle forward off the location bracket at lower rear of the oven.
- Clean fan baffle with mild anti bacterial detergent and hot water solution using a soft bristled brush.
- Dry fan baffle thoroughly with a soft dry cloth before re-fitting.
- Clean the lamp glass using a soft cloth with a mild anti bacterial detergent and hot water solution.
- Dry the lamp glass thoroughly with a dry cloth.
- Refit the fan baffle onto the location bracket below the fan.
- Whilst holding the fan baffle in place, refit the lamp glass, screw the glass in clockwise to secure the fan baffle in place. **Do not over tighten lamp glass.**

Cleaning

Door Seal

- a. To remove door seal, pull the 1 piece seal forward until it pulls out of the location groove around the oven. **Note the way the seal is fitted to the oven, with the lip facing inwards.**



- b. Check for wear and damage to the door seal and replace as required.
- c. Wash the door seal in a sink, taking care not to cut or damage the seal.
- d. Dry the door seal thoroughly.
- e. Refit the door seal with lip facing into centre of the oven.



- f. Press the door seal into the locating groove in the front face of the oven until the seal is properly located all around the oven.



Oven Interior

- **Allow the oven interior to cool to approx 50°C - 120°F before commencing cleaning.**
 - a. Remove the oven racks, element guard and the fan baffle as shown previously.
 - b. Clean any build up of grease from the oven interior, using a mild anti bacterial detergent and hot water solution and a soft bristled brush.
 - c. Dry the oven thoroughly with a soft dry cloth.
 - d. Clean the oven regularly with a good quality oven cleaner.

Door Glass Cleaning

- **Ensure that the oven door is cool before cleaning the oven door glass.**

- a. Open the oven door.
- b. Lift up the bottom of the inner glass at the centre of the door to unlock from the inner glass retaining catches and swing the glass inwards towards the oven.

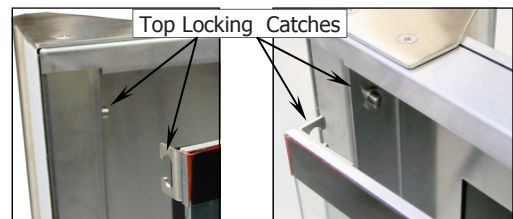
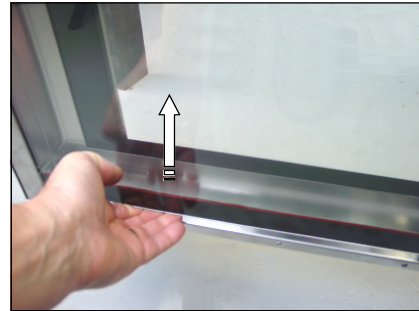

- c. Clean both sides of the inner glass and the inner side of the outer door glass with a conventional glass cleaner.
- d. Dry the oven door thoroughly with a soft dry cloth.
- e. Swing the inner glass back towards the outer door.
- f. Whilst holding the outer door, lift the inner glass back onto the locking catches until the inner glass is securely held.

Fault Finding

This section provides a reference to the more common problems that may occur during the operation of your oven. This fault finding guide is intended to help you correct and accurately diagnose problems with your oven.

You may encounter a problem not covered in this section, please contact your service provider who will require the following information:-

When fault finding a problem, always use a process of elimination starting with the simplest solution and working through to the most complex. Never overlook the obvious.

- **The Model and Serial Number of the oven, can be found on the Technical Data Plate located on the front right hand side panel of the oven.**

Fault	Possible Causes	Remedy
Oven does not operate.	Mains isolating switch, circuit breaker or fuses are 'Off' at the power board.	Turn 'On'.
	Overtemp tripped (No lights, no power light).	Call for service.
	Overtemp faulty.	Call for service.
	Digital Controller faulty	Call for service.
Oven Controller operates but No Heat in Oven.	Digital Controller faulty	Refer to 'Digital Controller Fault Codes'. Call for service.
	Door not closed fully.	Close door. (Refer 'Door does not close fully').
	Door Switch faulty.	Call for service.
	Heating Relay faulty.	Call for service.
	Element faulty.	Call for service.
Oven heats up but fan does not operate.	Fan motor faulty.	Call for service.
	Fan or fan motor obstructed.	Call for service.
Door does not close fully.	Tray in way of door.	Correctly position tray in rack.
	Door mis-aligned.	Re-align door.
	Door seal obstruction.	Correctly install door seal. (Refer to the 'Cleaning' Section).
Oven light not illuminating.	Blown bulb.	Replace bulb.
Uneven cooking.	Too high a temperature selected.	Select a lower temperature.
	Oven or racks not level.	Check oven racks and level.
	Insufficient air space around trays or baking tins.	Ensure oven racks are spaced to allow air flow around baking on all shelves.
	Oven overloaded with too much product.	Re-load oven.
	Opening oven door un-necessarily.	Ensure oven door remains closed during the baking process.
	Oven door seal damaged or faulty.	Check seals and replace if damaged.
	Oven vent restricted.	Ensure oven vent not blocked or shrouded.
'Err 001' on display.	Probe error.	Call for service.
'Err 003' on display.	Digital input error.	Call for service.

Electrical Schematics

Electrical Schematic E31D4 Turbofan Oven

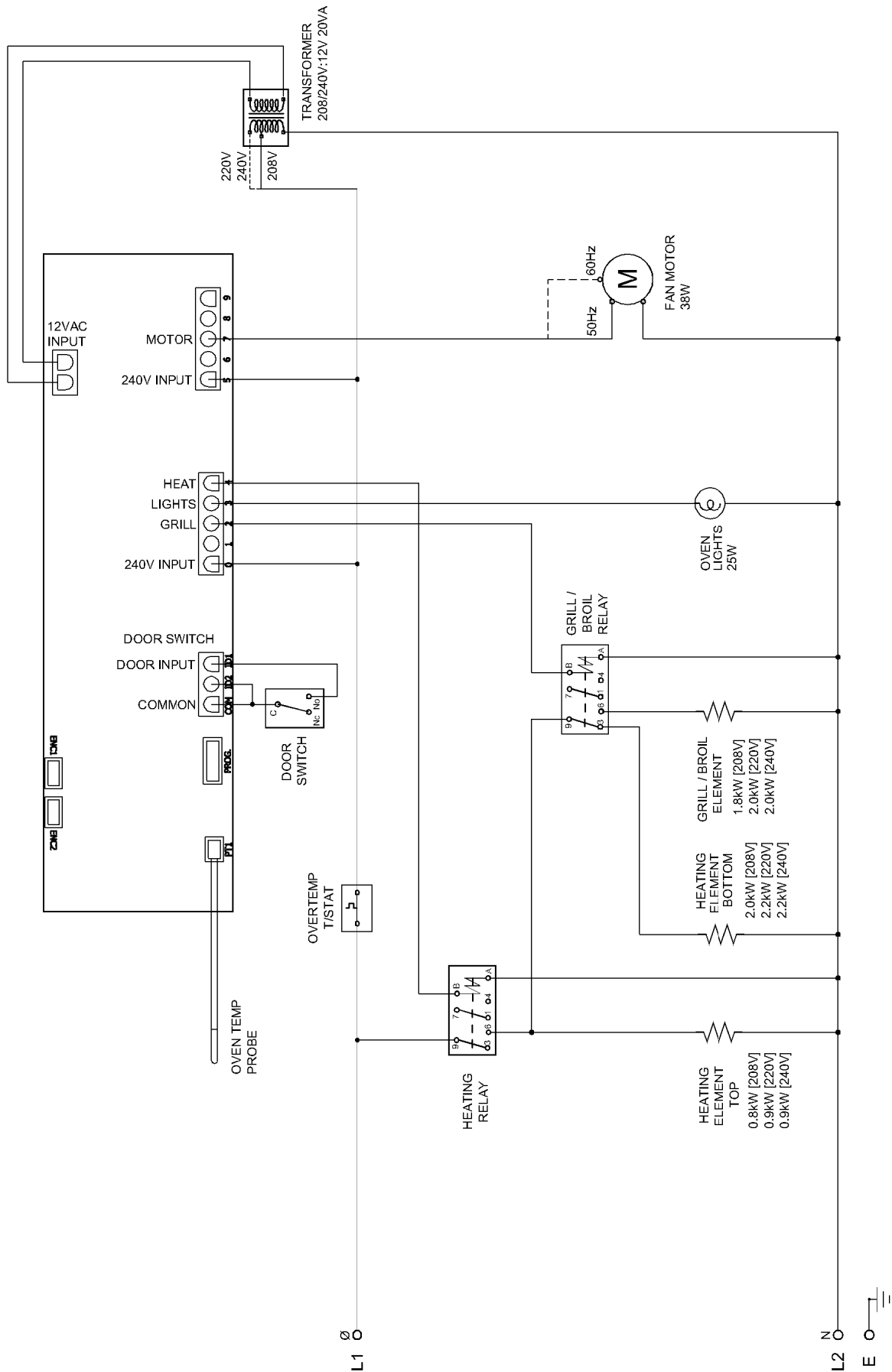

Replacement Parts List

Important:

**Only genuine authorized replacement parts should be used for the servicing and repair of this oven. The instructions supplied with the parts should be followed when replacing components.
For further information and servicing instructions, contact your nearest authorized service provider or Turbofan Dealer.**

When ordering replacement parts, please quote the part number and the description as listed below. If the part required is not listed below, request the part by description and quote model number and serial number which is shown on the Technical Data Plate.

Item	Description
234631	Digital Control Board Kit E31D4
234429	Transformer 208 / 240V x 12V AC SEC, 20VA
234450	Encoder
234434	Temperature Probe 20 mm PT1000 1 mtr
234202	Oven Bottom Element, 2000W, 230 - 240V
234203	Oven Bottom Element, 2000W, 208 - 220V
234462	Oven Top Element, 230 - 240V
234463	Oven Top Element, 208 - 220V
013431K	Fan Motor Kit, 208 - 240V, 50/60Hz
025400	Overtemp, 360°C - 680°F
233573	Overtemp Cap
233862	Door Microswitch
234447	Knob Indexed
233115	Oven Lamp Lens
231814	Lamp Bulb G9 25W, Halogen, 230V
234580	Door Roller Catch
234582	Door Catch Strike
234626	Door Hinge Top
234627	Door Hinge Bottom
234464	Door Seal - E31
232379	Foot Adjustable (73 - 80 mm)
234204	Oven Side Rack LH, E31
234205	Oven Side Rack RH, E31
233567	Oven Rack E31D
233552	Rack Securing Screw

