

# Attachment Illustrated Parts List



## Attachment

Mfg. No.	Description
1694958	50" Mulch Kit

## **Simplicity**

MANUFACTURING, INC.  
500 N. Spring Street / PO Box 997  
Port Washington, WI 53074-0997 USA

[www.simplicitymfg.com](http://www.simplicitymfg.com)

© Copyright 2007 Simplicity Manufacturing, Inc. All Rights Reserved. Printed In USA.

**Part No.:** 1734856

**Rev.** 04/2007

TP 400-4572-00-AT-SMA

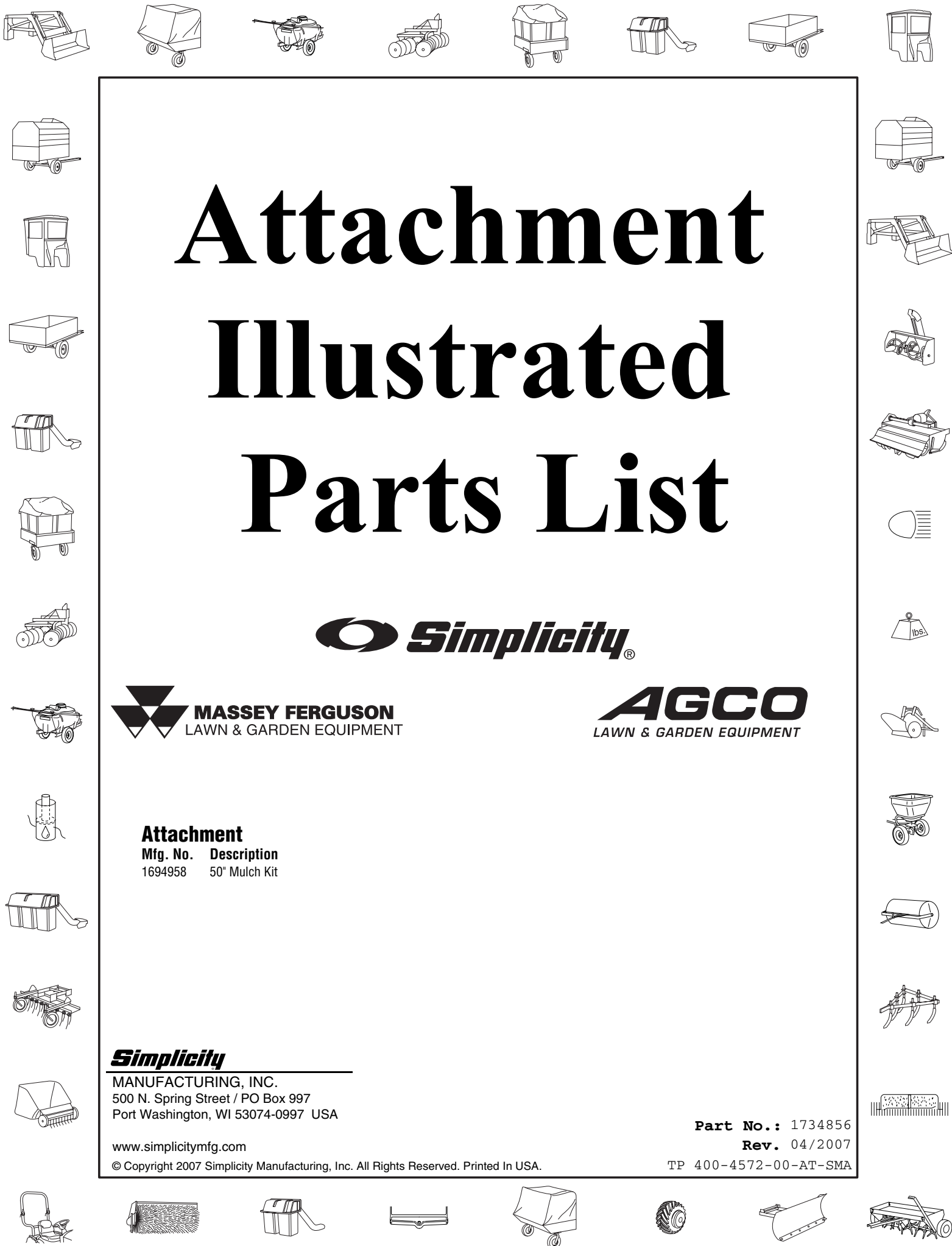



<b>PRODUCT COMPONENTS</b>	<b>PAGES</b>
44 & 50" Grass Mulcher Kit .....	4
<b>Torque Specification Chart</b> .....	<b>Inside Back Cover</b>

## 44 & 50" Grass Mulcher Kit

NOTE: Unless noted otherwise,  
use the standard hardware torque  
specification chart.

1694957

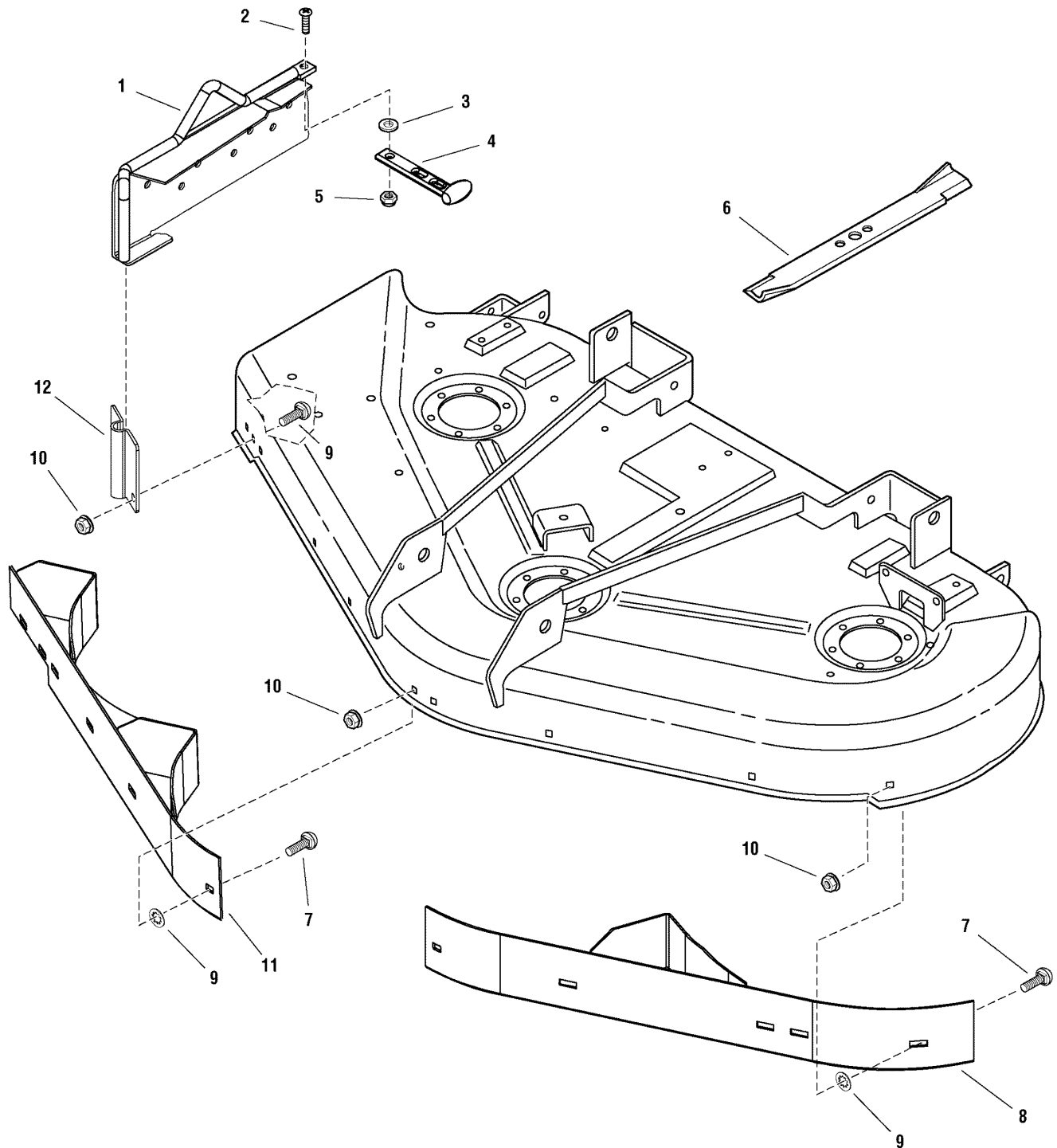

The above parts group applies to the following Mfg. Nos.:

1694958 - 50" Mulch Kit

## 44 & 50" Grass Mulcher Kit

---

REF NO	PART NO.	QTY.	DESCRIPTION
1	1732198ASM	1	BAFFLE ASSEMBLY, 44"
1	1732349ASM	1	BAFFLE ASSEMBLY, 50"
2	1960393SM	1	SCREW, Phillips, #10-24 x 1
3	1960096SM	1	WASHER
4	2171600SM	1	STRAP, Rubber
5	1933896SM	1	NUT, Hex, Nylock, #10-24
6	1716696ASM	3	BLADES, Mower 44"
6	1716697ASM	3	BLADES, Mower 50"
7	1931332SM	10	CARRIAGE BOLT, 5/16-18 x 5/8
8	1721946ASM	1	BAFFLE & DEFLECTOR, LH 44"
8	1716150ASM	1	BAFFLE & DEFLECTOR, LH 50"
9	1933988SM	8	NUT, Push, 5/16
10	1927557SM	10	NUT, Hex, Flange Lock, 5/16-18
11	1729370ASM	1	BAFFLE & DEFLECTOR, RH
11	1726913ASM	1	BAFFLE & DEFLECTOR, RH 50"
12	1726578ASM	1	PLATE, Mounting

### Footnotes

---

The above parts group applies to the following Mfg. Nos.:

1694958 - 50" Mulch Kit



# Hardware Identification & Torque Specifications

## Common Hardware Types

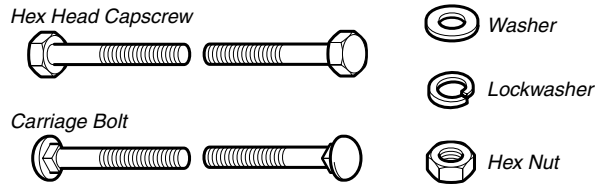

## Standard Hardware Sizing

When a washer or nut is identified as **1/2"**, this is the *Nominal size*, meaning the *inside diameter* is 1/2 inch; if a second number is present it represent the *threads per inch*

When bolt or capscrew is identified as **1/2 - 16 x 2"**, this means the *Nominal size*, or *body diameter* is 1/2 inch; the second number represents the *threads per inch* (16 in this example, and the final number is the *body length* of the bolt or screw (in this example 2 inches long).

**The guides and ruler furnished below are designed to help you select the appropriate hardware and tools.**

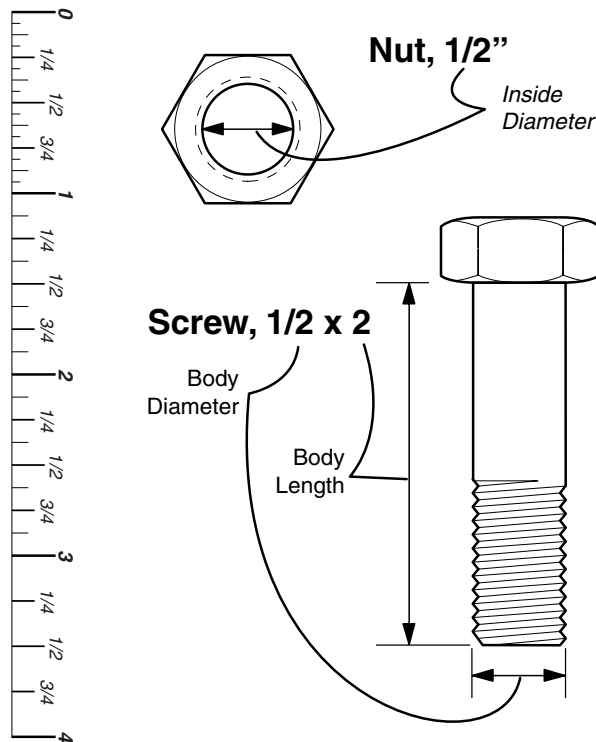

## Torque Specification Chart

FOR STANDARD MACHINE HARDWARE (Tolerance  $\pm 20\%$ )

Hardware Grade	No Marks		SAE Grade 2		SAE Grade 5		SAE Grade 8	
	in/lbs	Nm.	in/lbs	Nm.	in/lbs	Nm.	in/lbs	Nm.
8-32	19	2.1	30	3.4	41	4.6		
8-36	20	2.3	31	3.5	43	4.9		
10-24	27	3.1	43	4.9	60	6.8		
10-32	31	3.5	49	5.5	68	7.7		
1/4-20	66	7.6	8	10.9	12	16.3		
1/4-28	76	8.6	10	13.6	14	19.0		
5/16-18	11	15.0	17	23.1	25	34.0		
5/16-24	12	16.3	19	25.8	27	34.0		
3/8-16	20	27.2	30	40.8	45	61.2		
3/8-24	23	31.3	35	47.6	50	68.0		
7/16-14	30	40.8	50	68.0	70	95.2		
7/16-20	35	47.6	55	74.8	80	108.8		
1/2-13	50	68.0	75	102.0	110	149.6		
1/2-20	55	74.8	90	122.4	120	163.2		
9/16-12	65	88.4	110	149.6	150	204.0		
9/16-18	75	102.0	120	163.2	170	231.2		
5/8-11	90	122.4	150	204.0	220	299.2		
5/8-18	100	136	180	244.8	240	326.4		
3/4-10	160	217.6	260	353.6	386	525.0		
3/4-16	180	244.8	300	408.0	420	571.2		
7/8-9	140	190.4	400	544.0	600	816.0		
7/8-14	155	210.8	440	598.4	660	897.6		
1-8	220	299.2	580	788.8	900	1,244.0		
1-12	240	326.4	640	870.4	1,000	1,360.0		

### NOTES

- These torque values are to be used for all hardware excluding: locknuts, self-tapping screws, thread forming screws, sheet metal screws and socket head setscrews.
- Recommended seating torque values for locknuts:
  - for prevailing torque locknuts - use 65% of grade 5 torques.
  - for flange whizlock nuts and screws - use 135% of grade 5 torques.
- Unless otherwise noted on assembly drawings, all torque values must meet this specification.

## Wrench & Fastener Size Guide



1/4" Bolt or Nut  
Wrench—7/16"

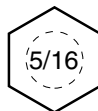

5/16" Bolt or Nut  
Wrench—1/2"

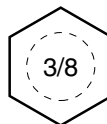

3/8" Bolt or Nut  
Wrench—9/16"



7/16" Bolt or Nut  
Wrench (Bolt)—5/8"  
Wrench (Nut)—11/16"

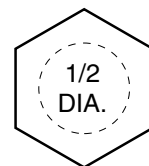

1/2" Bolt or Nut  
Wrench—3/4"

