

CV2017J

JENSEN

20" TV / DVD Combination

USER MANUAL



Please read this manual carefully before using this TV set and keep it for future reference.

PRECAUTIONS

FCC WARNING-This equipment may generate or use radio frequency energy.Changes or modifications to this equipment may cause harmful interference unless the modifications are expressly approved in the instruction manual.The user could lose the authority to operate this equipment if an unauthorized change or modification is made.

LASER SAFETY

This unit employs a laser.Only a qualified service person should remove the cover or attempt to service this device,due to possible eye injury.

CAUTION:USE OF CONTROLS OR ADJUSTMENTS OR PERFORMANCE OF PROCEDURES OTHER THAN THOSE SPECIFIED HEREIN MAY RESULT IN HAZARDOUS RADIATION EXPOSURE.

CAUTION:VISIBLE AND INVISIBLE LASER RADIATION WHEN OPEN AND INTERLOCK DEFEATED.DO NOT STARE INTO BEAM.

LOCATION:INSIDE,NEAR THE DECK MECHANISM.

CONTENTS

Before Operation

Warning and cautions..... 1

Installation.....4

 Antenna Connection.....4

 Preparation of the remote control.....4

Function buttons and External Connections.....5

 Front panel of the TV set.....5

 Rear panel of the TV set.....5

Using the remote control.....6

Basic operation

Menu Functions.....9

DVD Operation

DVD Features..... 18

Advanced Playback..... 19

Special Function Playback..... 20

DVD System Setup..... 21

Playable Discs..... 25

Disc Protection and DVD Characteristics..... 26

Others

Connection to the external audio and video equipment.....27

Troubleshooting guide.....28

Specifications 29

Important safety Instructions

WARNING: TO REDUCE THE RISK OF FIRE OR ELECTRIC SHOCK, DO NOT EXPOSE THIS APPLIANCE TO RAIN OR MOISTURE.



CAUTION

**RISK OF ELECTRIC SHOCK
DO NOT OPEN**



CAUTION: TO REDUCE THE RISK OF ELECTRIC SHOCK, DO NOT REMOVE COVER (OR BACK). NO USER SERVICEABLE PARTS INSIDE. REFER SERVICING TO QUALIFIED SERVICE PERSONNEL



THIS SYMBOL INDICATES THAT DANGEROUS VOLTAGE CONSTITUTING A RISK OF ELECTRIC SHOCK IS PRESENT WITHIN THIS UNIT.



THIS SYMBOL INDICATES THAT THERE ARE IMPORTANT OPERATING AND MAINTENANCE INSTRUCTIONS IN THE LITERATURE ACCOMPANYING THE APPLIANCE.

The important note is located on the rear of the cabinet.

IMPORTANT SAFEGUARDS

1. READ INSTRUCTIONS

All the safety and operating instructions should be read before the unit is operated.

2. RETAIN INSTRUCTIONS

The safety and operating instructions should be retained for future reference.

3. HEED WARNINGS

All warnings on the unit and in the operating instructions should be adhered to.

4. FOLLOW INSTRUCTIONS

All operating and use instructions should be followed.

5. CLEANING

Unplug this unit from the wall outlet before cleaning. Do not use liquid cleaners or aerosol cleaners.

Use a damp cloth for cleaning the exterior cabinet only.

6. ATTACHMENTS

The manufacturer of this unit does not make any recommendations for attachments, as they may cause hazards.

7. WATER AND MOISTURE

Do not use this unit near water. For example, near a bathtub, washbowl, kitchen sink, laundry tub, in a wet basement, or near a swimming pool.

8. ACCESSORIES

Do not place this unit on an unstable cart, stand, tripod, bracket, or table. The unit may fall, causing serious injury, and serious damage to the unit.

(symbol provided by RETAC)

8A. An appliance and cart combination should be moved with care. Quick stops, excessive force, and uneven surfaces may cause the appliance and cart combination to overturn.

S3126A



9. VENTILATION

Slots and openings in the cabinet back or bottom are provided for ventilation, and to ensure reliable operation of the unit, and to protect it from overheating. These openings must not be blocked or covered. The openings should never be blocked by placing the unit on a bed, sofa, rug, or other similar surface. This unit should never be placed near or over a radiator or heat source. This unit should not be placed in a built-in installation such as a bookcase or rack unless proper ventilation is provided or the manufacturer's instructions have been adhered to.

10. POWER SOURCE

This unit should be operated only from the type of power source indicated on the rating plate. If you are not sure of the type of power supply to your home, consult your appliance dealer or local power company. For units intended to operate from battery power, or other sources, refer to the respective pages in this Owner's Manual for their operating instructions.

Important safety Instructions

11. GROUNDING OR POLARIZATION

This unit is equipped with a polarized alternating-current line plug (a plug having one blade wider than the other). This plug will fit into the power outlet only one way. This is a safety feature. If you are unable to insert the plug fully into the outlet, try reversing the plug. If the plug should still fail to fit, contact your electrician to replace your obsolete outlet. Instead of the polarized alternating-current line plug, your unit may be equipped with a 3-wire grounding-type plug (a plug having a third (grounding) pin). This plug will only fit into a grounding-type power outlet. This too, is a safety feature. If you are unable to insert the plug into the outlet, contact your electrician to replace your obsolete outlet. Do not defeat the safety purpose of the grounding-type plug.

12. POWER-CORD PROTECTION

Power-supply cords should be routed so that they are not likely to be walked on or pinched by items placed upon or against them, paying particular attention to cords at plugs, convenience receptacles, and the point where they exit from the appliance.

13. LIGHTNING

To protect your unit from a lightning storm, or when it is left unattended and unused for long periods of time, unplug it from the wall outlet and disconnect the antenna or cable system. This will prevent damage to the unit due to lightning and powerline surges.

14. POWER LINES

An outside antenna system should not be located in the vicinity of overhead power lines or other electric light or power circuits, or where it can fall onto or against such power lines or circuits. When installing an outside antenna system, extreme care should be taken to keep from touching such power lines or circuits, as contact with them might be fatal.

15. OVERLOADING

Do not overload wall outlets and extension cords, as this can result in a risk of fire or electric shock.

16. OBJECT AND LIQUID ENTRY

Do not push objects through any openings in this unit, as they may touch dangerous voltage points or short out parts that could result in fire or electric shock. Never spill or spray any type of liquid into the unit.

17. OUTDOOR ANTENNA GROUNDING

If an outside antenna or cable system is connected to the unit, be sure the antenna or cable system is grounded to provide some protection against voltage surges and built-up static charges. Section 810 of the National Electrical Code (NEC), ANSI/NFPA 70, provides information with respect to proper grounding of the mast and supporting structure, grounding of the lead-in wire to an antenna discharge unit, size of grounding conductors, location of antenna discharge unit, connection to grounding electrodes, and requirements for the grounding electrode.

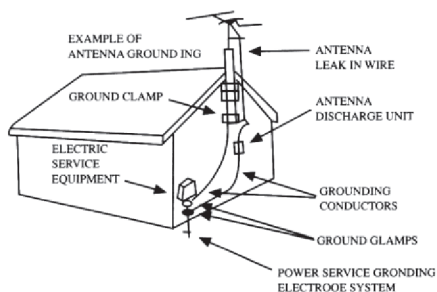

18. SERVICING

Do not attempt to service this unit yourself as opening or removing covers may expose you to dangerous voltage or other hazards. Refer all servicing to qualified service personnel.

Important safety Instructions

19. DAMAGE REQUIRING SERVICE

Unplug this unit from the wall outlet and refer servicing to qualified service personnel under the following conditions:

- a. When the power-supply cord or plug is damaged.
- b. If liquid has been spilled, or objects have fallen into the unit.
- c. If the unit has been exposed to rain or water.
- d. If the unit does not operate normally by following the operating instructions. Adjust only those controls that are covered by the operating instructions, as an improper adjustment of other controls may result in damage and will often require extensive work by a qualified technician to restore the unit to its normal operation.
- e. If the unit has been dropped or the cabinet has been damaged.
- F. When the unit exhibits a distinct change in performance, this indicates a need for service.

20. REPLACEMENT PARTS

When replacement parts are required, be sure the service technician uses replacement parts specified by the manufacturer or those that have the same characteristics as the original part. Unauthorized substitutions may result in fire, electric shock or other hazards.

21. SAFETY CHECK

Upon completion of any service or repairs to this unit, ask the service technician to perform safety checks to determine that the unit is in proper operating condition.

22. HEAT

The product should be situated away from heat sources such as radiators, heat registers, stoves, or other products (including amplifiers) that produce heat.

23. DISC SLOT

Keep your fingers well clear of the disc slot as it is closing. It may cause serious personal injury.

24. CONNECTING

When you connect the product to other equipment, turn off the power and unplug all of the equipment from the wall outlet. Failure to do so may cause an electric shock and serious personal injury. Read the owner's manual of the other equipment carefully and follow the instructions when making any connections.

25. SOUND VOLUME

Reduce the volume to the minimum level before you turn on the product. Otherwise, sudden high volume sound may cause hearing or speaker damage.

26. SOUND DISTORTION

Do not allow the product output distorted sound for a long time. It may cause speaker overheating and fire.

27. LASER BEAM

Do not look into the opening of the disc slot or ventilation opening of the product to see the source of the laser beam. It may cause sight damage.

28. DISC

Do not use a cracked, deformed, or repaired disc. These discs are easily broken and may cause serious personal injury and product malfunction.

29. NOTE TO CABLE TV SYSTEM INSTALLER

This reminder is provided to call the Cable TV system installer's attention to Article 820-40 of the NEC that provides guidelines for proper grounding and, in particular, specifies that the cable ground shall be connected to the grounding system of the building, as close to the point of cable entry as practical.

Installation

Antenna connection

Generally speaking, to enjoy a clearer picture, we recommend that you use a CATV system or an outdoor antenna. In different places, the suitable antenna type and position may vary.

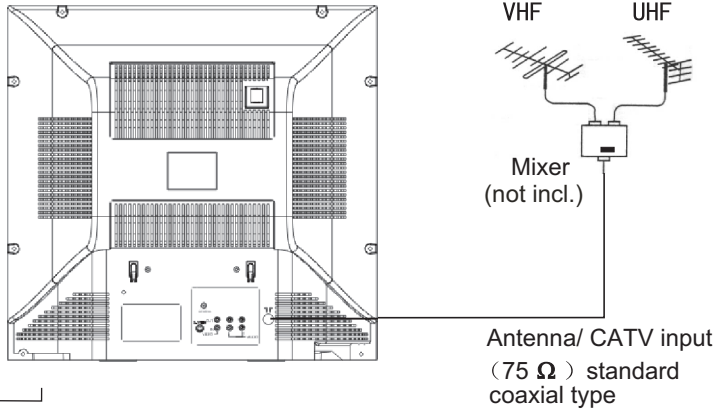

Note:

- * It is recommended that a 75 ohm coaxial antenna is used to avoid interference.
- * To avoid interference from electrical signals, do not bind the antenna cable together with any mains lead.

Preparation for the remote control

Battery installation

Remove the battery cover.

Insert two size AA batteries matching the +/- polarities of the battery to the +/- marks inside the battery compartment.

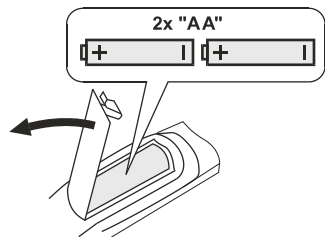

Tips for remote operation

When the remote control will not be used for a long period of time or when the batteries are worn out, remove the batteries to prevent leakage.

Do not throw the batteries into fire. Dispose of used batteries in the specified manner.

Do not drop, dampen or disassemble the remote control.

Function Buttons and External Connections

Front panel the TV set

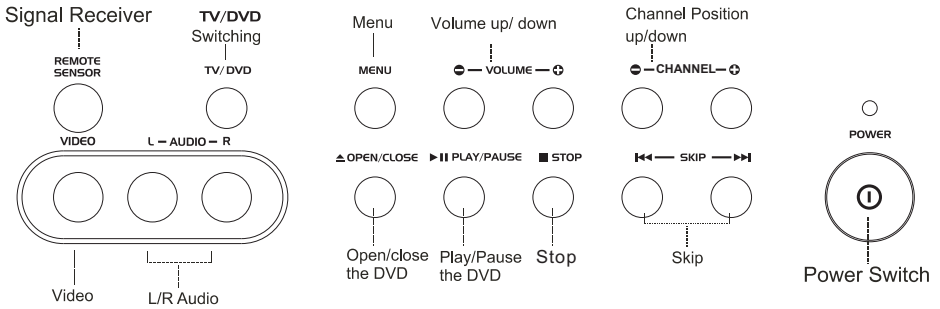

Rear panel of the TV set

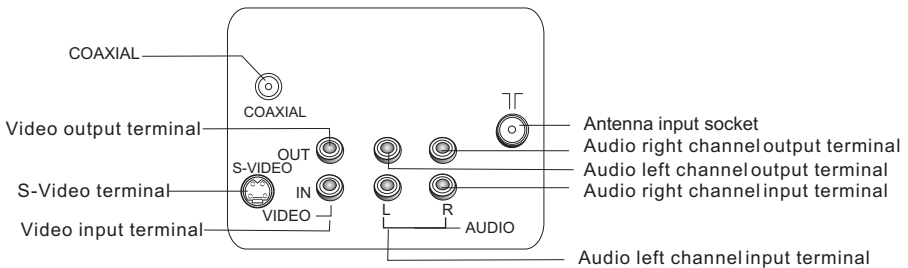
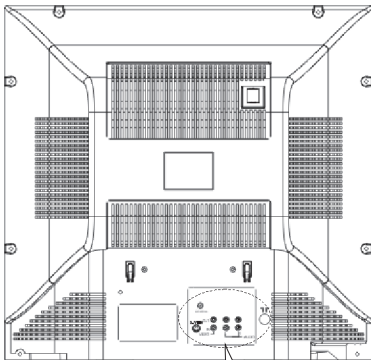

Using the Remote Control

Buttons on the remote control

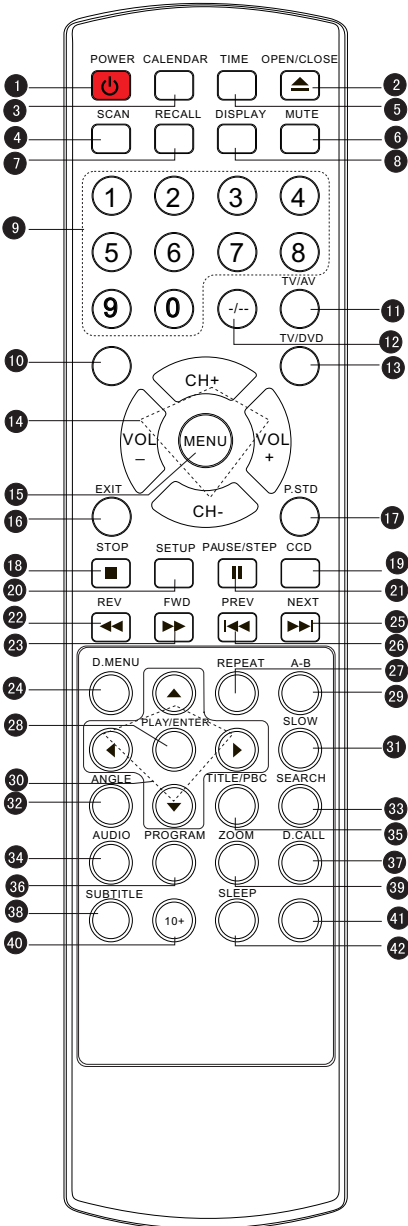

- 1 Power Switch
- 2 Open/close DVD Tray
- 3 Calendar Function
- 4 Channel Scan
- 5 TV Time Menu
- 6 Mute Sound
- 7 Return to Previous Channel
- 8 On Screen Display
- 9 Channel / Track Selection
- 10 (Non Functional)
- 11 TV / AV Mode Selection
- 12 Select 1 or 2 Digit Channel / Track Number Inputting
- 13 TV / DVD Mode Selection
- 14 Volume/Channel Adjusting
- 15 Go to TV Menu
- 16 Exit On Screen Display
- 17 Adjust Picture Mode
- 18 DVD STOP Playback
- 19 CCD (closed caption) On / Off
- 20 Enter DVD SETUP
- 21 DVD PAUSE/STEP
- 22 DVD FAST REVERSE
- 23 DVD FAST FORWARD
- 24 DVD MENU
- 25 DVD NEXT Chapter / Track
- 26 DVD PREVIOUS Chapter / Track
- 27 DVD REPEAT Mode
- 28 DVD Playback / Confirm Menu Selection
- 29 DVD A-B REPEAT
- 30 DVD Cursor Move button
- 31 DVD SLOW
- 32 DVD ANGLE Change
- 33 DVD SEARCH
- 34 DVD AUDIO Mode
- 35 DVD TITLE
- 36 DVD PROGRAM
- 37 DVD INFORMATION
- 38 DVD CAPTION (SUBTITLE) Selection
- 39 Zoom Function
- 40 10+
- 41 (Not available)
- 42 TV Sleep button

Using the Remote Control (Continued)

Remote Control Features

Power Button:

To turn power ON or OFF , press power button on remote control.

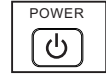

System and Channel Display Button:

This will show you the current channel number. System type will also be displayed if set.

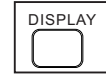

DVD/TV Button:

Press this button to change between TV and DVD mode.

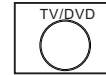

Sleep Timer Button:

This feature allows you to turn off television in pre-selected minutes (180, 170, 160,, 10 and 0). To cancel, keep pressing button until you exit out.



TV/AV input Button:

This button has three settings: A) Video 1, B) Video 2, C) SVHS, D) TV . Pressing this button will cycle you through each input type.

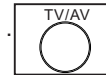

Mute Button:

Press mute button to turn off the TV volume.



Direct Channel Access Selection:

Follow one of the procedures noted below to access a channel.



One Digit Channel Selection:

When you want to select one digit channel ,press 0 and channel number digit.

Two Digit Channel Selection:

When you want to select two-digit channel. Press the digit button twice, then enter the two channel digits .

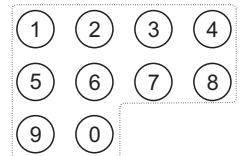

Three Digit Channel Selection:

When you want to select a three digit channel. Press the digit select button three times, then enter the three digits .

CCD Button:

Press CCD button to set the C.Caption (Closed Captioning).

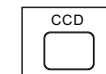

OPEN/CLOSE Button:

Press this button to open or close the DVD disc tray .



Using the Remote Control (Continued)

Channel (+/-) Select Button:

You can go up and down the channels by pressing CH (+) button and CH (-) button. This button can also be used in adjusting the functions in the Menu Mode.

Menu Select Button:

You can select the menu by pressing the MENU button. You can call on the menu (PICTURE, TIME, TUNE and FUNCTION) by pressing the corresponding button on the remote control.

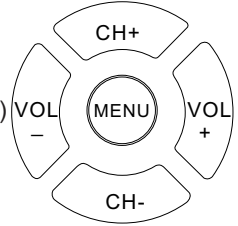

Volume (+/-) Select Button:

You can increase the volume by pressing VOL (+) button and decrease VOL (-) button. This button can also be used in adjusting the function selections in the Menu Mode.

Last Channel Recall Button:

This feature allows you to recall the previously viewed channel.



Picture Preference Select Button:

By pressing this exclusive personal preference button, you can select different preset brightness shades for various viewing environments.

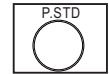

Program Scan Button:

This feature automatically scans the available channels. Pressing it again stops the channel scanning.



System and Channel Display Cancel Button:

This button allows you to turn off the channel display and exit system menus.

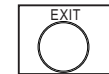

Time Menu Button:

When pressed it displays Time Menu Screen.



10+ Button:

This button can also be used to select 2 digit channel numbers.



Menu Functions

Information to user: This television receiver is equipped with close caption decoder and parental blocking technology as required by the FCC.

Menu Functions

Video Setup:

Pressing MENU button once will bring the Video Setup menu on the TV. The following is shown on your TV screen:



Follow the procedure below to adjust the picture quality of your choice:

1. Press the CH(+) and CH(-) button to go up and down the menu.
2. Press the VOL(+) and VOL(-) button to increase and decrease the level to your preference for each item.

Picture Quality Adjustments:

- Picture:** By increasing the level. It will adjust white areas of picture and by decreasing the level, it will adjust black areas of picture.
- Brightness:** By decreasing the level, the brightness level will be decreased. By increasing the level, the brightness level will be increased.
- Color:** By decreasing the level, color intensity will be decreased. By increasing the level, color intensity will be increased.
- Sharpness:** By decreasing the level, the picture becomes softer. By increasing the level, the picture becomes clearer.
- Hue:** This setting allows you to adjust the tint of the picture. By decreasing the level, it will give red tint to skin color and by increasing the color it will give green tint to skin color.
- Color Temp :** Press the VOL(-/+) buttons to select from three color temperature settings: A)Neutral, B)Warm, C)Cool.

Menu Functions (Continued)

Audio Setup:

By pressing MENU button ,and then pressing VOL(-/+) buttons it will bring you to Audio Setup display. You will see the following menu on your TV screen:



Follow the procedure below to adjust the sound quality:

Press VOL (+) button to increase and VOL (-) button to decrease the level to your preference.

Timer Setup:

By pressing MENU button ,and then pressing VOL(-/+) buttons it will bring you to Timer Setup display. You will see the following menu on your TV screen:



Follow the procedure below to select one of the above options:

1. Press the CH(+) and CH(-) button to go up and down the menu.
2. Press VOL (+) button or VOL (-) button to select your preference.

Clock: Press VOL (-/+) buttons for HOURS and VOL(-/+) buttons for MINUTES adjustment.

Time-On: Press VOL(-/+) buttons for HOURS and VOL (-/+) buttons for MINUTES adjustment. This feature works like an alarm clock. Your TV will turn on at the set time.

Ch. Select: This feature switches you to your favorite channel at the set time. Press VOL(+) and VOL(-) buttons to select the channel.

Time-Off : Press VOL (+/-) buttons for HOURS and VOL (+/-) buttons for MINUTES adjustment. This feature works like an alarm clock. Your TV will turn off at the set time.

Sleep Time: This feature allows you to turn off the television after a pre-selected number of minutes (180, 170,160,,10 and 0).

Remind Time: Press VOL(+/-) buttons to set HOURS of attention and VOL (+/-) buttons to set MINUTES of attention. You will see the flashing time on your TV when the reminder time arrives. Note: This exclusive feature can remind you of important tasks when watching TV.

Ch. Switch: This feature lets you store your favorite channel. Once you store the channel number in this function, when the set time is up, it will switch over to the set channel. This feature is used with the Exchange feature. Press VOL(+) or VOL(-) button to select the channel.

Menu Functions (Continued)

Function Setup:

By pressing the MENU button, and then pressing VOL(-/+) buttons, you will enter the Function Setup menu. You will see the following menu on your screen:



Follow the procedure below to select one of the above options:

1. Press the CH(+) and CH(-) button to go up and down the menu.
2. Press the VOL(+) and VOL(-) button to increase and decrease the level to your preference for each item.

Language: Use VOL(-/+) buttons to select the OSD language.

Background: Press the VOL (-/+) buttons to select between Background ON or Background OFF. When the Background ON function is chosen, a moving "NO SIGNAL" sign will be displayed if there is no input signal to the set.

Black Stretch: Press VOL (-/+) buttons to turn the Black Stretch feature on or off. When the Black Stretch function is on, the screen automatically increases the contrast range.

VNR: Press VOL (-/+) buttons to turn the VNR function on or off. VNR is a term for Video Noise Reduction, a built-in device that reduces video noise interference so the viewer is assured a clear picture.

Fade: FADE control allows for the picture tube to warm up and gently turn on, which can help prolong the life of the picture tube.

AVL: Automatic Volume Limit control reduces effect of large volume changes such as when the ads come on. Press VOL(+) button or VOL(-) button to set it ON or OFF.

Soft Change: Press VOL (-/+) buttons to turn the Soft Change feature on or off.

C.Caption: Press VOL (-/+) buttons to select the Closed Caption options. Closed Captioning helps the hearing impaired with the broadcast program, as well as helping children learn how to read. A built in decoder displays the audio portion of a program as text on the screen when this option is selected.

OFF: When OFF is displayed on TV, it means C.Caption is turned off.

CC1: When Cc1is displayed on TV means C.Caption is turned on.

CC2 to CC4: For other modes of video related broadcast information.

T1: For program guide and other information displayed by broadcasters. (This blocks a large portion of the picture on your screen).

T2 to T4: For other modes of information displayed by broadcasters.

(This blocks a large portion of the picture on your screen).

IMPORTANT: Closed captioning availability entirely depends on broadcasters supplying the signal. Therefore, closed captioning might not always be available and language availability will differ by broadcast.

Note: Select CC1 for full translation of the primary language such as English in your area. Select CC2 for secondary language translation such as French or any other language that may be broadcast in your area.

Demo Mode: This will display the main functions of the TV set.

Menu Functions (Continued)

Channel setup:

By pressing MENU button, and then pressing VOL-/+ button it will bring you to Channel Setup menu. You will see the following display on TV screen.

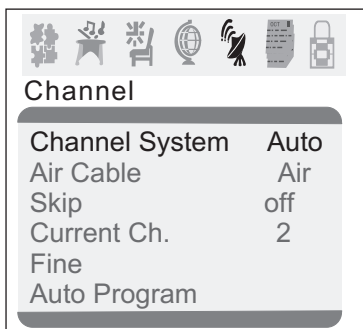

Follow the procedure below to select above options:

1. Press the CH(+) and CH(-) button to go up and down the menu.
2. Press VOL (+) button or VOL (-) button to select your preference.

Channel System: Press the VOL(-/+) buttons to select the correct channel system.

In general, you can set it as "AUTO" (AUTO,NTSC and NTSC443 will display in turn)

Air Cable: Press VOL (+) button or VOL(-) button to select Aerial Antenna (VHF and UHF) or Cable Antenna (CATV) reception preference.

Skip : Press VOL(+) button or VOL(-) button to add or delete a channel from the stored memory.

Current Ch. : Press VOL(+) button to go up and VOL (-) button to go down to set the channel position. The display will show the current playing channel.

Channel Coverage by Antenna:

Antenna Type	Channel Range
VHF	2-13
UHF	14-69
CATV	1-125

Fine: If the picture and/or sound are poor, try using the FINE TUNE feature. Do not use this feature unless reception is poor. Press VOL (+/-) to start the Fine Tune function.

Auto Program: Press VOL (+) button to auto program channels. This search automatically adds only the active channels in your area to the TV's memory. It deletes any channels on which there is no broadcast or a poor signal.

Note: The Auto Search function will scan the channels on the selected antenna input. If the TV is connected to cable, please select Cable under ' Air Cable ' sub menu.

Menu Functions (Continued)

Calendar:

Your TV has been designed with a calendar. By pressing MENU button ,and then pressing VOL(-/+) buttons it will bring you to Calendar. You will see the following display on TV screen.



Follow the procedure below to adjust the Calendar date:

1. Press the CH(+/-) buttons to select the year item, the month item or the date item.
2. Press the VOL(-/+) buttons to change the year, month or day.
3. Press EXIT button to exit the calendar mode.

Menu Functions (Continued)

PARENTAL LOCK Setup:

Press the MENU Button on your remote control to go to Password menu, then input the password (0000). It will bring Parental Lock set up menu onto the screen. You will see the following menu on your screen:

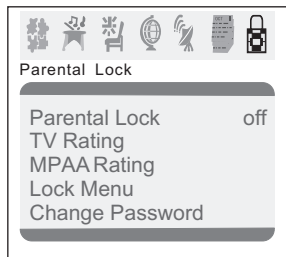

This function enables you to lock certain TV channels in accordance to the V-CHIP requirement established by the FCC.

To setup the PARENTAL LOCK function:

Select the TV Rating option. You will see the TV Rating menu on your TV screen:

1. Press CH(+/-) buttons to go up and down the menu.
2. Press VOL(-/+) buttons to go into TV Rating and Movie Rating menus.
3. Press VOL(-/+) buttons to set the Parental Lock ON and Parental Lock OFF.

When TV rating is selected, you will see the following rating table on your TV screen.

Rating	FV	D	L	S	V
TV-Y	>U				
TV-Y7	U	U			
TV-G	U				
TV-PG	U	U	U	U	U
TV-14	U	U	U	U	U
TV-MA	U		U	U	U

Note: You can press CH(+/-) buttons to go up and down the menu, then press VOL(+) button to select "B" (block channel) or "U" (unblock channel).

Menu Functions (Continued)

When MPAA Rating is selected, you will see the following rating table on your TV screen.

MPAA Rating	
G	U
P G	U
P G - 1 3	U
R	U
NC-17	U
X	U

- Parental Lock off means the lock function is turned off. If the Parental Lock is in "off" mode then function will not be active to accept the broadcast signal.
- Parental Lock on means the lock function is turned on. If the lock is in the "on" mode then function is activated to accept the broadcast signal.

Password

The "Default Password" preset by the manufacturer is "0000". If you want to change the preset password to your own password, just choose any four digits that can be easily remembered and set. Once you set password for a particular channel, that channel will be blocked. This channel can only be accessed with the password.

Lock Menu

AV Lock: When it is set to ON, the AV inputs are locked and therefore the TV will not allow you to view sources hooked up via AV inputs on the front and back of the TV. To unlock this feature, simply set this option to OFF

Program Lock: When it is set to ON, the current channel is locked and can therefore not be viewed. To view the channel (unlock) once again, set this option to OFF.

Menu Functions (Continued)

PARENTAL LOCK TECHNOLOGY:

The "P.L. Technology" allows you to use U.S. and Canadian Movies and TV PROGRAMS Guide ratings to block certain types of TV programs and movies.

To clearly understand TV program rating codes, read the following information:

U.S. TV Program Ratings

- NR: Not Rated-this means that programs are not rated or rating does not apply.
- TV-Y: For all children - these types of rated programs are designed for a very young audience, including children from ages 2-6.
- TV-Y7: Directed towards older children - this type of rated programs may include comedic violence of mild physical, or may frighten children under the age of 7.
- TV-G: General audience - these types of rated programs contains little or no violence, no strong language, and little or no sexual dialogue and situations.
- TV-PG: Parental Guidance Suggested-this type of rated programs may contain limited violence, some suggestive sexual dialogue and situations, and rare language.
- TV-14: Parents strongly cautioned-these types of rated programs may contain sexual content, strong language and more intense violence.
- TV-MA: Mature audience only these types of rated programs may contain sexual violence, explicit sexual content and profane language.
- FV: This type of rated programs contain Fantasy and cartoon violence.
- Violence: This type of rated programs contain violence.
- S: This type of rated programs contain sex.
- L: This type of rated programs contain offensive language.
- D: This type of rated programs contain dialogue with sexual content.

Menu Functions (Continued)

To understand clearly about movie rating codes, read the following list:

U.S. Movie Rating Chart

NR: This means movie is not rated yet. It is pending government rating approval.

G: General Audience-this type of movie rating means all ages admitted to see the movie.

PG-13:Parents Strongly Cautioned - this type of movie rating means some material may not be appropriate for children under13.

R: Restricted- This type of movie rating means children under 17 of age require to be with parent or guardian.

NC-17:This type of movie rating means no one 17 and under admitted.

X: This type of movie rating means adults only.

To clearly understand Canadian program rating codes, read the following list:

Canadian English Rating Chart

E: These types of programs are exempt from the rating system. Exempt programming includes: news, sports, documentaries, talk shows, music videos, and variety of other programs.

C: This type of programming is intended for children under age 8. There is no offensive language, nudity or sexual content.

C8+:These types of rated programs are generally considered acceptable for children 8 years and over. There is no profanity, nudity or sexual content.

G: These types of rated programs are generally suitable for all audiences.

PG: Parental Guidance Suggested -in these types of rated programs, some material may not be suitable for children.

14+: In these types of rated programs, some content may not be suitable for viewers under the age of 14.Parents are strongly cautioned not to have their children view 14+ rated programs by pre-teens and early teens.

18: Adults Only-these types of rated programs are only for adult viewers only.

DVD Features

Basic Playback

Preparations

- Press the DVD/TV button on the remote control or the TV to enter the DVD status.

Basic playback

1. Press OPEN/CLOSE to open the disc tray, place a disc in the disc tray.
 - There are two different disc sizes. Place the disc in the correct guide on the disc tray. If the disc is out of the guide, it may damage the disc and cause the DVD player to malfunction.
 - Do not place a disc which is unplayable in this DVD player.
2. Press OPEN/CLOSE to close the disc tray, the playback will automatically start.
 - Some discs do not start automatically. Press PLAY/ENTER to start playback.
3. Some discs may start playback with a menu. Use the cursor buttons on the remote control to select menu options and press PLAY/ENTER to start. You may also press the digit buttons to select a menu option directly. Many DVDs will not allow this during start-up.

Pause playback

1. Press PAUSE/STEP to pause playback (still mode). The sound will be muted during still mode.
2. Press PLAY/ENTER to resume normal playback.

Stop playback

1. Press STOP ■ button to go to stop mode, the TV screen will show the start logo. As some disc the player can recall the location where stopped, such as DVDs and audio CDs.
2. Press PLAY/ENTER to playback to resume playback from the location where playback is stopped or from the beginning of the disc.
3. Press STOP twice to stop completely.

Previous and Next

During Playing, pressing the PREV ◀ key will restart the current chapter and skip chapters backwards with each subsequent press until the start of the disc is reached. Each press of NEXT ▶ key during playing will skip the current chapter and play the next one.

Fast forward and Fast reverse

1. Press FWD ►► to fast forward through the disc. Each time the FWD ►► button is pressed, the fast forward motion speed changes.
2. Press PLAY/ENTER to resume normal playback.
3. Press REV ◀◀ to fast reverse through the disc. Each time the REV ◀◀ button is pressed, the fast reverse motion speed changes.
4. Press PLAY/ENTER to resume normal playback.

Single step playback

1. When paused, press PAUSE/STEP continuous to single step forward to the next frame in the video.
2. Press PLAY/ENTER to resume normal playback.

DVD Features(Continued)

Advanced Playback

IMPORTANT NOTE:

ALL DESCRIBED FUNCTION IS FOR DVD DISCS. IF YOU PLAY OTHER FORMAT DISCS, THE OPERATION AND ON SCREEN DISPLAY WILL BE DIFFERENT.

SUBTITLE

Press "SUBTITLE", the screen will display "SUBTITLE 01/XX XXXXX", "01" indicates the ordinal number of this language; "XX" indicates total number of language; "XXXXXX" indicates the language of country. (the number of language depends on disc). This function can select up to 32 languages displayed on screen.

REPEAT

Press "REPEAT" and Chapter repeat will be displayed on screen, the second press will display Title repeat, the third press will display All repeat, the fourth press will cancel this function.

A-B

Press "A-B" to begin start-point, press again to set an end point and complete setting. The selected section A-B will be repeated. The third press will cancel this function.

ANGLE

When enjoying sports, concert or theatre, press this key to watch same actions in different angles. (Valid for discs possessing this function. Using a disc recorded in multi-angle you can view the scene from different angles, for example, front, side, whole view and exterior scene).

D.MENU

Press this key to display root menu, select item according to your preference. (This function will work with a DVD having a multi-layer menu.)

D.CALL

Pressing this key will cycle through "Title Elapsed", "Title Remain", "Chapter Elapsed", "Chapter Remain" and "Display off".

PROGRAM

When playing discs, press "PROGRAM" to enter program mode. Press the digit buttons to select the program number that you want. When finished move the cursor to select "START". This will start the program playback.

SEARCH

Press "SEARCH" once to display the search menu. Press the button again to select. Press the program number buttons to input the item you require. Press PLAY/ENTER to confirm.

SLOW

Press SLOW to play a disc in slow forward. Each time the SLOW button is pressed, the slow motion speed changes. Press PLAY/ENTER to resume normal playback;

Note: This function does not work for CD and MP3.

TITLE/PBC

With some DVD discs pressing this key will display the title menu. You can then use the digit buttons to select the item you prefer.

AUDIO

Press this key can change the mode of audio. such as: Audio 1/2: AC 3 2 CH English
Audio 2/2: AC 3 5.1 CH English
Press this button to cycle between Mono Left, Mono Right, Mix-Mono and Stereo.

Note: When press this button continuously, you must above 3 seconds interval.

Special Function Playback

JPEG DISC PLAYBACK

When a disc containing standard JPEG picture files is inserted into the player, a navigation menu will be displayed automatically. Use the UP and DOWN cursor buttons to select a file then press PLAY/ENTER. The slide show will commence. Press PREVIOUS or NEXT to move between pictures. Press pause to stop on the current picture. Press PLAY/ENTER to resume normal playing.

A JPEG disc contains JPEG (.jpg) format picture information that can be decoded by a micro-computer software and displayed through the video output interface or on the television screen.

This function has many applications. For example one can save files from a scanner or digital camera in the JPEG format, record these on a CD-R disc and present them to an audience through this player.

The JPEG format is a convenient method to store images in a small amount of memory space, and is ideal for archiving information.

MP3 PLAYBACK

When playing an MP3 disc, a navigation menu will be displayed automatically. In the menu, use UP or DOWN cursor buttons to choose the folder, then press PLAY/ENTER to enter the folder. Use the UP and DOWN cursor buttons to select the file and press PLAY/ENTER. Pressing the LEFT cursor button will take you to the previous screen/menu.

SCREEN SAVER FUNCTION

This unit employs a screen saver mode to help protect the tube during static video pictures. This can be turned off on the GENERAL SETUP PAGE.

DVD System Setup

DVD System Setup

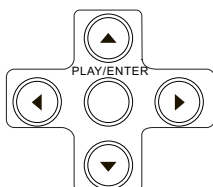

General Setup Process

1. Press the SETUP button, the General Setup Page, Preference Page will be displayed in turn.

2. Press ▲ or ▼ to select, the item, then press ► to enter the submenu.

3. Press ▲ or ▼ to select then press PLAY/ENTER to confirm.

4. Press EXIT key or press SETUP repeatedly to exit the set-up menus.

..General Setup Page..	
TV Display	LB 4: 3:Ps
Angle Mark	On 4: 3:Lb
OSD Lang	ENG 16: 9
Spdif Output	
Caption	On
Screen Saver	Off

..Preference Page..	
Parental	1 Kid Saf
Password	2 G
Default	3 Pg
	4 Pg 13
	5 Pgr
	6 R
	7 Nc17
	8 Adult

General Setup Page

ASPECT RATIO DESCRIPTION

When using the DVD with the internal TV, select 4: 3/LB.

The following information applies only when the DVD output is connected to an external TV.

- 4:3/PS (PS = Pan and Scan)

You may select if you have a normal aspect ratio (4:3) TV, although the NORMAL/LB (letter box) is a more common choice. In PS

mode, widescreen material will fill the screen, but at the expense of chopping off extreme left and right edges of the original film picture. For this feature to work, the disc must be specially coded. Such discs are uncommon.

- 4:3/LB (LB = Letter Box)

You may select this if you have a normal aspect ratio (4:3) TV. Widescreen material will be shown in pure unaltered form, allowing the entire picture area of the original film to be viewed without any side cropping. Black bars will appear above and below the picture.

- 16:9

You may select this if you have a widescreen (16:9) TV. Back bars may still appear above and below the picture even if using a widescreen TV. This is because some film directors prefer to use ultra widescreen aspect ratios e.g. 2.35:1. This will normally be indicated on the DVD packaging.

..General Setup Page..	
TV Display	LB 4: 3:Ps
Angle Mark	On 4: 3:Lb
OSD Lang	ENG 16: 9
Spdif Output	
Caption	On
Screen Saver	Off

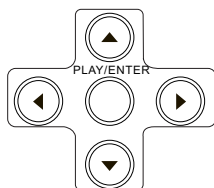

DVD System Setup(Continued)

DVD System Setup

General Setup Page

ANGLE MARK: Users can select a particular camera angle when playing a DVD which offers multiple angles.

This item allows you to set Angle Mark ON or OFF.

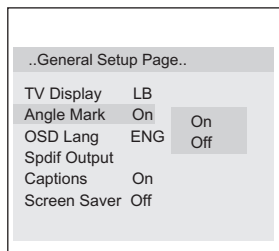

On Screen Display (OSD) Language: Users can select on-screen display language.

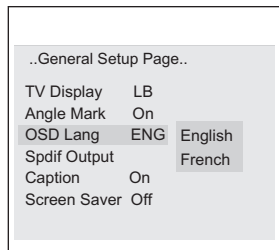

SPDIF OUTPUT MODE: Sets the audio outputs.

This DVD player includes three kinds of audio output:

1. **SPDIF OFF:** An analog surround sound format is output through the back-panel connections for 2-CH audio out or 5.1 CH audio out.
2. **SPDIF/RAW or SPDIF/PCM:** This surround sound format is output to a Dolby Digital/DTS decoder through the coaxial connector on the back panel of the product.

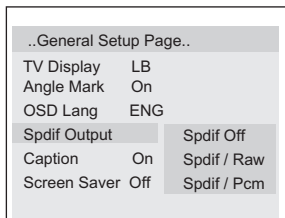

CAPTIONS: This function allows you to display or hide the caption.

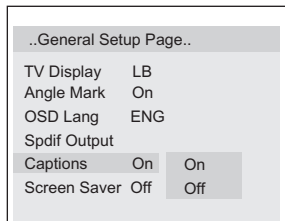

SCREEN SAVER: If the screen saver is on, then there will be an animated picture of DVD on the screen whenever the DVD player is idle for more than 3 minutes .

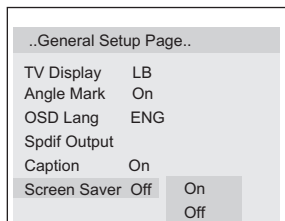

DVD System Setup(Continued)

DVD System Setup

Preference Page

The Preference Page is only available when there is no disc in the player. These settings are applied consistently to all discs which are inserted and played.

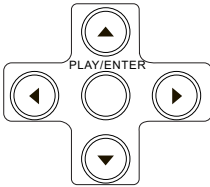

PARENTAL: The parental control function works in conjunction with the different censorship classes assigned to DVDs. These classes help to control the types of DVDs that the family watches, There are up to 8 censorship classes for DVDs.

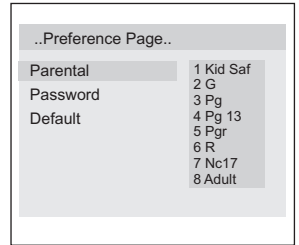

Note:

- 1 To change this setting you must enter your password. (Initial password is 0000)
- 2 When set to OFF, all discs may be viewed.

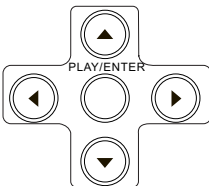

PASSWORD CHANGE:

You can change your password by entering 4 digits. You must confirm the 4 digits before the new password can be accepted.

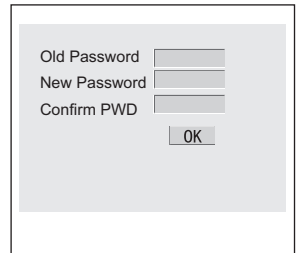
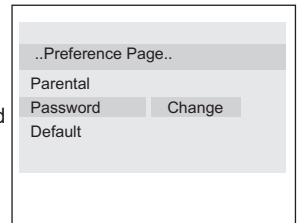

NOTE: If you forget your password or a password is accidentally set enter 2881 as the password. This will enable you to regain control.

DVD System Setup(Continued)

DVD System Setup

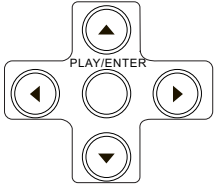

DEFAULT: Resets all settings (except password and parental lock status) for this DVD player back to the manufacturers original settings. Press ENTER to perform the reset.

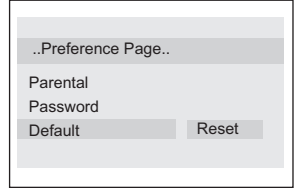









Note:

Some functions may not be available depending on the type of disc.

Playable Discs

The following discs can be played:

DISCS	LABEL	CONTENTS	DIMENSION
DVD VIDEO		Audio +Video (moving picture)	12cm
			8cm
AUDIO CD		Audio	12cm
			8cm
HDCD		Audio	12cm
			8cm
MP3		Audio	12cm
			8cm
JPEG		Video(picture)	12cm
			8cm
KODAK CD		Video(picture)	12cm
			8cm
CD-R		Audio or Video (moving picture)	12cm
			8cm
CD-RW		Audio or Video (moving picture)	12cm
			8cm
CD+G		Audio(picture)	12cm
			8cm

- You cannot play discs other than those listed above.
- You cannot play non-standardized discs, even if they may be labelled as above.
- The performance of CD-R or CD-RW disc depends on the way the disc was burned. In a few cases, their performance may not be consistent or may not even operate at all.

This DVD Player is designed and manufactured according to the Region Management Information that is recorded on a DVD disc. If the Region number described on the DVD disc does not correspond to the Region number of this DVD Player, this DVD player will not play that disc.

This Region number of this DVD Player is .



Disc Protection and DVD Characteristics

ON HANDLING DISCS

- Do not touch the playback side of the disc.
- Do not attach paper or tape to disc.

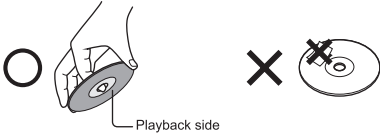

ON CLEANING DISCS

- Fingerprints and dust on the disc cause picture and sound deterioration. Wipe the disc from the centre outwards with a soft cloth. Always keep the disc clean.



- If you can not wipe off the dust with a soft cloth, wipe the disc lightly with a slightly moistened soft cloth and finish with a dry cloth.
- Do not use any type of solvent such as thinner, benzene, commercially available cleaners or anti-static spray for vinyl Lps. It may damage the disc.

ON STORING DISCS

- Do not store discs in a place subject to direct sunlight or near heat source.
- Do not store discs in place subject to moisture and dust such as a bathroom or near a humidifier.
- Store discs vertically in a case. Stacking or placing object on discs outside of their case may cause warping.

STRUCTURE OF DISC CONTENTS

Normally, DVD discs are divided into titles, and the titles are sub-divided into chapters. Audio CD are divided into tracks.

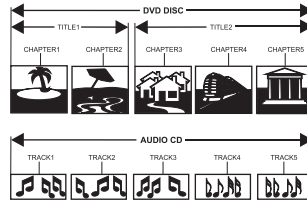

Each title, chapter, or track is assigned a number, which is called title number, chapter number or track number respectively.

There may be discs that do not have these number.

Compare DVD disc with other discs:

	DVD				LD	SVCD	VCD	CD
Encode method	Digital/MPEG II				Analog	Digital	Digital/MPEG I	Digital
Capacity	Single-side single-layer 4.7G	Double-side single-layer 8.5G	Single-side double-layer 9.4G	Double-side double-layer 17G	/	650MB	650MB	650MB
Playing Time	133 minutes	242 minutes	266 minutes	484 minutes	Single-side 60 minutes double-side 120 minutes	45 minutes	74 minutes	74 minutes
Disc diameter	12cm/8cm				30cm/20cm	12cm	12cm	12cm/8cm
Horizontal resolution	More than 500 line				No more than 430 line	No more than 350 line	No more than 250 line	/
Picture proportion	Multiple kinds				One kind	One kind	One kind	/
Subtitle	32 kinds				16 kinds at most	4 kinds	/	/
Language	8 kinds				4 kinds at most	4 kinds at most	2 kinds	2 kinds
Sound quality	48KHz, 96KHz/ 6, 20, 24bit				44.1KHz/ 16bit	44.1KHz/ 16bit	44.1KHz/ 16bit	44.1KHz/ 16bit

Connecting the TV set to the other video and audio equipment

Connection of AV input/output terminal

The figure below shows how to connect external equipment using AV signals.

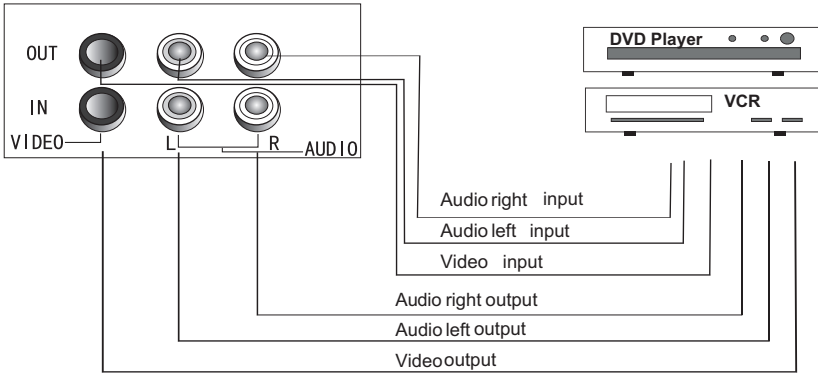



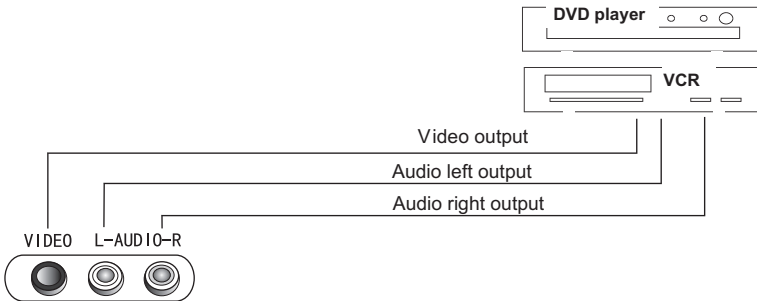













There is also an AV input on the front of your television. Use the Left Audio input (white terminal on the TV), if you are connecting equipment with mono sound. The MONO sound will be delivered by both left and right speakers.

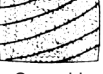

Troubleshooting guide

- To assist in location possible faults use help guide below.

BREAKDOWN PHENOMENON		CHECKING
PICTURE	SOUND	
 Picture with snow	 Noise	The aerial direction and connection
 Double or Triple Image	 Normal	This is called "ghosting" and can be minimized with an outside aerial, and good quality cable and terminations. Altering the aerial direction can also minimize this effect.
 Disturb	 Noise	Electrical interference which can be caused by cars, motorbikes etc, Fluorescent lamps and dirty insulators on overhead power cables.
 Normal	 No sound	Volume Sound mute
 No Picture	 No sound	Ensure that the power supply is connected to the TV set and turned on. Also ensure that the TV set is not in "Listen Mode" or that the brightness and contrast are not turned down.
 No colour	 Normal volume	Adjust colour control
 Scramble	 Normal or Weak Volume	Adjust channel again
 Colour Spot	 Normal volume	Colour Purity is a fault that can be caused by moving the TV set, placing magnets near the TV screen or turning on/off household appliances such as vacuum cleaners near the TV set. Turn the TV off with the main power switch for 15 minutes. When the power is turned on again the TV set will automatically degauss the picture. In severe cases leave the TV set turned off overnight.

Note:

1. If the fault can not be corrected using the above guide consult with your local authorized service center.
2. The TV set must only be repaired by a qualified registered service person. Never attempt to remove the back cover as TV set has dangerous voltages inside that may cause a fatality or fire.
3. The cabinet may produce the occasional "snapping sound" This is normal and caused by the materials in the cabinet expanding with room temperature changes.

Specifications

- The specifications offered you here are for reference only. With product improvement there may be some differences between the description and the final product.

Specifications

Colour system	NTSC
Sound system	M
Picture tube	20" colour picture tube
Sound output power	2X2W (10% THD)
Power requirements	AC 120V~ 60Hz
Power consumption	≤ 80W
Dimension (WDH)	500 (Width) x480 (Depth) x485 (Height) (mm)
Accessories	Remote control X1 Owner's manual X1 Battery ('AA' size) X2 Warranty card X1

NOTE

Design and specifications are subject to change without notice.
Dimensions quoted in this manual are approximate.

JENSEN