



Use and Care & Installation Guide

Electric Range with Convection Oven



Safety Instructions4-7

Anti-Tip Device4, 44, 53



Operating Instructions, Tips

Aluminum Foil6, 31, 34, 39, 41, 47, 48

Child Lock-Out20

Clock and Timer 19, 20

Convection Cooking23-29

 Baking24

 Roasting27-29

 Special Roasting Rack27

 Timed Baking 25, 26

Features8, 9

Oven21, 22, 29-43

 Baking29-31

 Broiling38-40

 Control Panel and Settings 18-20

 Roasting34-37

 Self-Cleaning Instructions41-43

 Timed Baking32, 33

Power Outage 19

Surface Cooking 10-17

 Canning Tips 12

 Coil Surface Units 10, 12-15

 Cooktop Comparison 10

 Cookware Tips 14-16

 Halogen/Radiant Surface Cleaning 17

 Halogen/Radiant Surface Units ... 10-17



Problem Solver54-56

Thermostat Adjustment-
Do It Yourself33

More questions?...call
GE Answer Center® 800.626.2000



Care and Cleaning44-48

Anti-Tip Device44

Cooktop47, 48

Door Removal45

Halogen/Radiant Cooktop 17

Oven Light45

Self-Cleaning Instructions41-43



Installation49-53

Anti-Tip Device53

Flooring Under the Range50

Leveling53



Consumer Services59

Appliance Registration3

Important Phone Numbers59

Model and Serial Number Location3

Warranty Back Cover

Models: *JBP80* *JBP95*
JBP90

GE Appliances

164D2966P235
49-8724

10-95 CG





Congratulations! You have just purchased one of the most innovative and exciting products on the market today. A great deal of research and technology has gone into the development of this appliance and we believe that by choosing GE, you have made a wise investment that will provide years of enjoyment. With this range you not only get the assurance of GE quality, but many other exceptional features.

Convection Cooking

- Convection cooking has long been the choice of many professional chefs and bakers. How does it work? A fan at the rear of the oven gently circulates heated air evenly throughout the oven cavity, resulting in more uniformly browned foods, shorter cooking times and lower cooking temperatures.

QuickSet Self-Clean Oven Controls

- QuickSet controls make setting the self-clean cycle easy. The controls also feature hi/low broil, digital time and temperature display, a preheat signal and more.

Soft “Sure Grip” Handle

- The cushioned handle enhances the styling of the range while providing a comfortable grip and feel.

“Big View” Window

- An exclusive feature from GE, the big window makes it easy to check baking progress without opening the door.

Safety Features

- The four hot surface indicator lights let you know which surface unit is turned on or still too hot to touch. The control lock-out feature prevents children from turning on the oven without your permission.

Clean Well™ Cooktop System with Calrod® surface units and more

- The cooktop is recessed and has high spill rims around the Calrod® surface units to help contain spills on the top for easy cleaning. Plug-in surface units and one piece drip bowls are easily removed for cleaning.

Quick Cooking Response

- With halogen/radiant heating surface units you get fast, uniform cooking. The heat cycles on and off to maintain the temperature level.

QuickClean™ Design

- Hard to clean cracks and crevices are eliminated. The full-width glass cooktop is sealed to the porcelain enamel spill proof frame. The raised edges and recessed top contain spills.

Glass Cooktop

- This durable “glass ceramic” material is impact, stain and scratch resistant.

HELP US HELP YOU...



Before using your range, read this guide carefully.

It is intended to help you operate and maintain your new range properly.

Keep it handy for answers to your questions.

If you don't understand something or need more help, call:

GE Answer Center®
800.626.2000
24 hours a day, 7 days a week

Write down the model and serial numbers.

You'll find them on a label behind the range door or behind the storage drawer.

These numbers are also on the Consumer Product Ownership Registration Card that came with your range. Before sending in this card, please write these numbers here:

Model Number

Serial Number

Use these numbers in any correspondence or service calls concerning your range.

If you received a damaged range...

Immediately contact the dealer (or builder) that sold you the range.

Save time and money. Before you request service...

Check the Problem Solver in the back of this guide. It lists causes of minor operating problems that you can correct yourself.

IF YOU NEED SERVICE...

To obtain service, see the Consumer Services page on the inside back cover.

We're proud of our service and want you to be pleased. If for some reason you are not happy with the service you receive, here are three steps to follow for further help.

FIRST, contact the people who serviced your appliance. Explain why you are not pleased. In most cases, this will solve the problem.

NEXT, if you are still not pleased, write all the details—including your phone number—to:

Manager, Consumer Relations
GE Appliances
Appliance Park
Louisville, KY 40225

FINALLY, if your problem is still not resolved, write:

Major Appliance Consumer Action Program
20 North Wacker Drive
Chicago, IL 60606



IMPORTANT SAFETY INSTRUCTIONS

Read all instructions before using this appliance.

IMPORTANT SAFETY NOTICE

- **The California Safe Drinking Water and Toxic Enforcement Act** requires the Governor of California to publish a list of substances known to the state to cause birth defects or other reproductive harm, and requires businesses to warn customers of potential exposure to such substances.
- **The fiberglass insulation in self-clean ovens gives off a very small amount of carbon monoxide during the cleaning cycle.** Exposure can be minimized by venting with an open window or using a ventilation fan or hood.
- **Fluorescent light bulbs contain mercury.** If your model has a surface light, you must recycle the fluorescent light bulb according to local, state and federal codes.

When using electrical appliances, basic safety precautions should be followed, including the following:

- **Use this appliance only for its intended use** as described in this guide.
- **Be sure your appliance is properly installed and grounded** by a qualified technician in accordance with the provided installation instructions.
- **Do not attempt to repair or replace any part of your range unless it is specifically recommended in this guide.** All other servicing should be referred to a qualified technician.
- **Before performing any service, DISCONNECT THE RANGE POWER SUPPLY AT THE HOUSEHOLD DISTRIBUTION PANEL BY REMOVING THE FUSE OR SWITCHING OFF THE CIRCUIT BREAKER.**
- **Never wear loose-fitting or hanging garments while using the appliance.** Be careful when reaching for items stored in cabinets over the range. Flammable material could be ignited if brought in contact with hot surface units or heating elements and may cause severe burns.

▲ WARNING—

All ranges can tip and injury could result. To prevent accidental tipping of the range, attach it to the wall and floor by installing the Anti-Tip device supplied.

To check if the device is installed and engaged properly, remove the kick panel or storage drawer and inspect the rear leveling leg. Make sure it fits securely into the slot.

If you pull the range out from the wall for any reason, make sure the device is properly engaged when you push the range back against the wall. If it is not, there is a possible risk of the range tipping over and causing injury if you or a child stand, sit or lean on an open door.

Please refer to the Anti-Tip device information in this guide. Failure to take this precaution could result in tipping of the range and injury.

- **Do not leave children alone**—children should not be left alone or unattended in an area where an appliance is in use. They should never be allowed to sit or stand on any part of the appliance.
- **Do not allow anyone to climb, stand or hang on the door, kick panel or storage drawer or cooktop.** They could damage the range and even tip it over, causing severe personal injury.
- **CAUTION: ITEMS OF INTEREST TO CHILDREN SHOULD NOT BE STORED IN CABINETS ABOVE A RANGE OR ON THE BACKSPASH OF A RANGE—CHILDREN CLIMBING ON THE RANGE TO REACH ITEMS COULD BE SERIOUSLY INJURED.**
- **Do not store flammable materials in an oven or near the cooktop.**



- **Use only dry pot holders**—moist or damp pot holders on hot surfaces may result in burns from steam. Do not let pot holders touch hot surface units or heating elements. Do not use a towel or other bulky cloth.
- **DO NOT STORE OR USE COMBUSTIBLE MATERIALS, GASOLINE OR OTHER FLAMMABLE VAPORS AND LIQUIDS IN THE VICINITY OF THIS OR ANY OTHER APPLIANCE.**

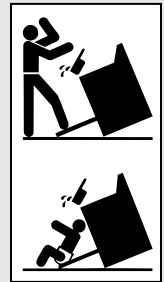



- **Do not let cooking grease or other flammable materials accumulate in or near the range.**
- **For your safety, never use your appliance for warming or heating the room.**
- **Keep the hood and grease filter clean to maintain good venting and to avoid grease fires.**



- **Do not use water on grease fires. Never pick up a flaming pan.**

Turn the controls off. Smother a flaming pan on a surface unit by covering the pan completely with a well-fitting lid, cookie sheet or flat tray. Use a multi-purpose dry chemical or foam-type fire extinguisher.

Flaming grease outside a pan can be put out by covering it with baking soda or, if available, by using a multi-purpose dry chemical or foam-type fire extinguisher.

Flame in the oven can be smothered completely by closing the oven door and turning the oven off or by using a multi-purpose dry chemical or foam-type fire extinguisher.

- **Do not touch the surface units, the heating elements or the interior surface of the oven.** These surfaces may be hot enough to burn even though they are dark in color. During and after use, do not touch, or let clothing or other flammable materials contact surface units, areas nearby surface units or any interior area of the oven; allow sufficient time for cooling, first.

Potentially hot surfaces include the cooktop, areas facing the cooktop, oven vent opening, surfaces near the opening, crevices around the oven door and metal trim parts above the door.

Remember: The inside surface of the oven may be hot when the door is opened.

- **When cooking pork,** follow the directions exactly and always cook the meat to an internal temperature of at least 170°F. This assures that, in the remote possibility that trichina may be present in the meat, it will be killed and the meat will be safe to eat.

Oven

- **Stand away from the range when opening the oven door.** Hot air or steam which escapes can cause burns to hands, face and/or eyes.
- **When using cooking or roasting bags in the oven,** follow the manufacturer's directions.
- **Do not heat unopened food containers.** Pressure could build up and the container could burst, causing an injury.
- **Keep the oven vent duct unobstructed.**
- **Keep the oven free from grease buildup.**
- **Place the oven shelf in the desired position while the oven is cool.** If shelves must be handled when hot, do not let pot holder contact the heating elements.
- **Pulling out the shelf to the shelf stop is a convenience in lifting heavy foods.** It is also a precaution against burns from touching hot surfaces of the door or oven walls.
- **Do not use your oven to dry newspapers.** If overheated, they can catch on fire.
- **Do not use oven for a storage area.** Items stored in an oven can ignite.
- **Do not leave paper products, cooking utensils or food in the oven when not in use.**

Self-Cleaning Oven

- **Do not clean the door gasket.** The door gasket is essential for a good seal. Care should be taken not to rub, damage or move the gasket.
- **Do not use oven cleaners.** No commercial oven cleaner or oven liner protective coating of any kind should be used in or around any part of the oven. Residue from oven cleaners will damage the inside of the oven when the self-clean cycle is used.
- **Clean only parts listed in this Use and Care Guide.**
- **Before self-cleaning the oven,** remove the broiler pan, grid and other cookware.
- **Be sure to wipe up excess spillage before starting the self-cleaning operation.**
- **If the self-cleaning mode malfunctions,** turn the oven off and disconnect the power supply. Have it serviced by a qualified technician.

(continued next page)



IMPORTANT SAFETY INSTRUCTIONS

(continued)

Surface Cooking Units (Electric Coil models only)



- **Use proper pan size**—Select cookware having flat bottoms large enough to cover the surface unit heating element. The use of undersized cookware will expose a portion of the surface unit to direct contact and may result in ignition of clothing. Proper relationship of the cookware to the surface unit will also improve efficiency.
- **Never leave the surface units unattended at high heat settings.** Boilovers cause smoking and greasy spillovers that may catch on fire.
- **Be sure the drip pans and the vent duct are not covered and are in place.** Their absence during cooking could damage range parts and wiring.
- **Do not use aluminum foil to line the drip pans** or anywhere in the oven except as described in this guide. Misuse could result in a shock, fire hazard or damage to the range.
- **Only certain types of glass, glass/ceramic, earthenware or other glazed containers are suitable for cooktop service;** others may break because of the sudden change in temperature.
- **To minimize the possibility of burns,** ignition of flammable materials and spillage, the handle of a container should be turned toward the center of the range without extending over the nearby surface units.
- **Always turn the surface units off before removing cookware.**
- **To avoid the possibility of a burn or electric shock,** always be certain that the controls for all surface units are at the off position and all coils are cool before attempting to lift or remove a unit.
- **Do not immerse or soak the removable surface units.** Do not put them in a dishwasher. Do not self-clean the surface units in the oven.
- **Clean the cooktop with caution.** If a wet sponge or cloth is used to wipe spills on a hot surface unit, be careful to avoid steam burns.
- **When flaming foods are under the hood,** turn the fan off. The fan, if operating, may spread the flame.
- **Keep an eye on foods being fried at high or medium high heat settings.**
- **Foods for frying should be as dry as possible.** Frost on frozen foods or moisture on fresh foods can cause hot fat to bubble up and over the sides of the pan.
- **Use little fat for effective shallow or deep-fat frying.** Filling the pan too full of fat can cause spillovers when food is added.
- **If a combination of oils or fats will be used in frying,** stir together before heating, or as fats melt slowly.
- **Always heat fat slowly, and watch as it heats.**
- **Use a deep fat thermometer** whenever possible to prevent overheating fat beyond the smoking point.



Halogen/Radiant Surface Units (on some models)



- **Use proper pan size**—Select cookware having flat bottoms large enough to cover the selected surface unit. The use of undersized cookware will expose a portion of the surface unit to direct contact and may result in ignition of clothing. Proper relationship of the cookware to the surface units will also improve efficiency.
- **Never leave the surface units unattended at high heat settings.** Boilovers cause smoking and greasy spillovers that may catch on fire.
- **Do not operate the halogen/radiant surface units if the glass is broken.** Spillovers or cleaning solution may penetrate a broken cooktop and create a risk of electrical shock. Contact a qualified technician immediately should your glass cooktop become broken.
- **Avoid scratching the glass cooktop surface.** The cooktop can be scratched with items such as sharp instruments, rings or other jewelry and rivets on clothing.
- **Never use the glass cooktop surface as a cutting board.**
- **Do not place or store items that can melt or catch fire on the glass cooktop, even when it is not being used.**
- **Do not stand on the glass cooktop.**
- **Be careful when placing spoons or other stirring utensils on glass cooktop surface** when it is in use. They may become hot and could cause burns.
- **To minimize the possibility of burns,** ignition of flammable materials and spillage, the handle of a container should be turned toward the center of the range without extending over the nearby surface units.
- **Always turn the surface units off before removing the cookware.**
- **Keep an eye on foods being fried at high or medium high heat settings.**

- **When flaming foods are under the hood, turn the fan off. The fan, if operating, may spread the flame.**
- **Foods for frying should be as dry as possible.** Frost on frozen foods or moisture on fresh foods can cause hot fat to bubble up and over the sides of the pan.
- **Use little fat for effective shallow or deep-fat frying.** Filling the pan too full of fat can cause spillovers when food is added.
- **If a combination of oils or fats will be used in frying,** stir together before heating, or as fats melt slowly.
- **Always heat fat slowly,** and watch as it heats.
- **Use a deep fat thermometer whenever possible** to prevent overheating fat beyond the smoking point.
- **Clean the cooktop with caution.** If a wet sponge or cloth is used to wipe spills on a hot surface unit, be careful to avoid steam burns. Some cleaners can produce noxious fumes if applied to a hot surface.
NOTE: We recommend that you avoid wiping any surface unit areas until they have cooled and the indicator has gone off. Sugar spills are the exception to this. Please see the Glass Cooktop Cleaning section.
When the cooktop is cool, use only the recommended cleaning cream brand cleaner to clean the cooktop.
- **Use care when touching the cooktop.** The glass surface of the cooktop will retain heat after the controls have been turned off.
- **To avoid possible damage to the cooking surface,** do not apply cleaning cream to the glass surface when it is hot.
- **After cleaning,** use a dry cloth or paper towel to remove all the cleaning cream residue.
- **Read and follow all instructions and warnings on the cleaning cream labels.**

**SAVE THESE
INSTRUCTIONS**



FEATURES OF YOUR RANGE

Not all features are on all models. Appearance may vary.

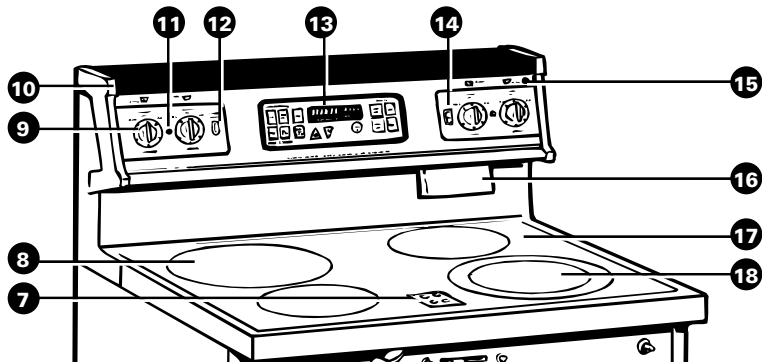

JBP90

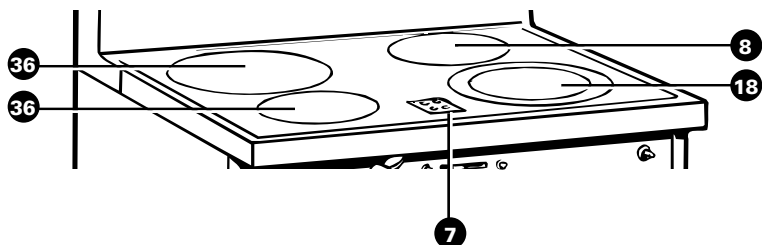
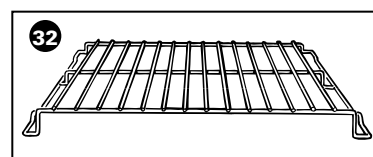
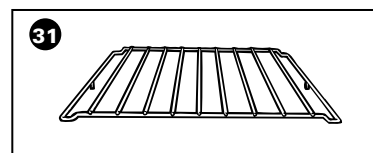
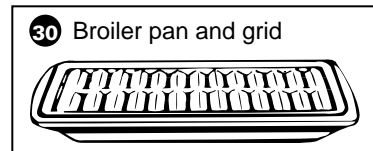
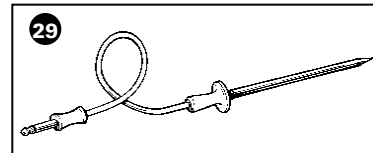

JBP95

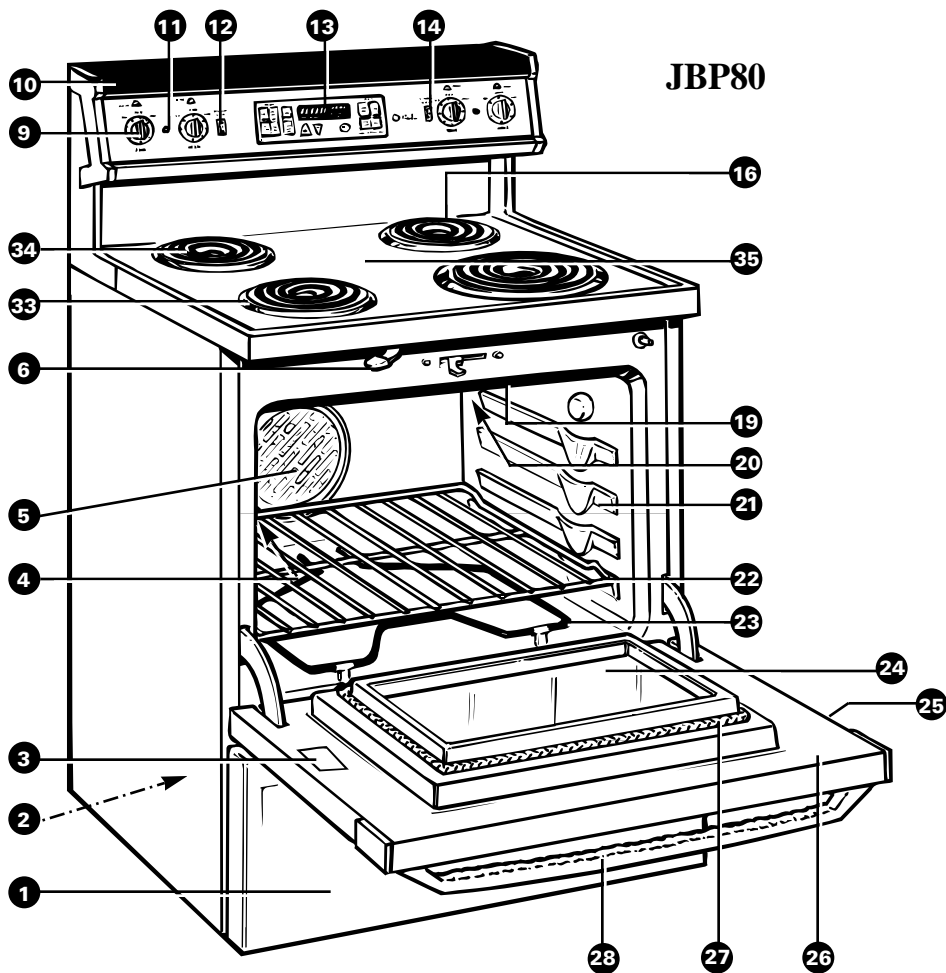

JBP80

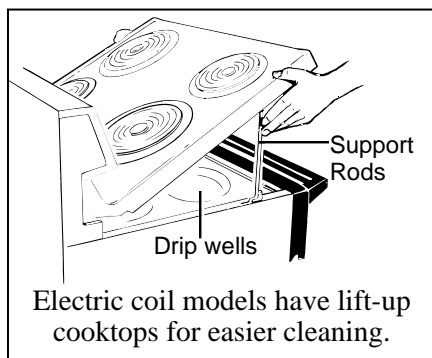

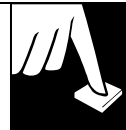

Feature Index*	Explained on page
1 Storage Drawer or Kick Panel	4, 46
2 Anti-Tip Device	4, 44, 49, 51
3 Anti-Tip Label	–
4 Probe Outlet	28, 36
5 Convection Fan Heating Element Operates during convection cooking.	23–26, 28
6 Oven Door Latch Used for self-cleaning only.	24, 25, 28, 29, 34, 38, 42, 43
7 Hot Surface Indicator Lights Glass Cooktop models only.	13, 14
8 Radiant Surface Units	7, 10–17
9 Surface Unit Controls	13, 44
10 Surface Light	13, 44
11 Surface Unit “On” Indicator Lights	13
12 Oven Light Switch	21
13 Oven Control, Clock and Timer	18–20
14 Surface Light Switch	13
15 Dual Surface Unit Switch Radiant models only.	14
16 Oven Vent	47
17 Glass Ceran Cooktop Halogen/Radiant models only.	2, 10–17
18 Dual Surface Unit Radiant models only.	14
19 Broil Element	5, 38, 47
20 Oven Interior Light Comes on automatically when the door is opened.	21, 41, 45

Feature Index*	Explained on page
21 Oven Shelf Supports Shelf positions for cooking are suggested in the Baking, Roasting and Broiling sections.	22, 24, 34, 40
22 Oven Shelf with Stop-Locks (number may vary)	22, 24, 30, 41, 43, 46
23 Bake Element May be gently lifted for wiping the oven floor.	5, 47
24 Oven Window	2, 31, 47
25 Model and Serial Number Location Behind the storage drawer.	3
26 Lift-Off Oven Door with Broil Stop Position Easily removed for cleaning.	4, 5, 38, 40, 41, 45
27 Oven Door Gasket	5, 41, 45
28 “Sure Grip” Handle	2, 44
29 Probe	28, 35, 36, 46
30 Broiler Pan and Grid	27, 34, 38, 39, 46
31 Roasting Rack	27, 46
32 Offset Shelf with Stop-Locks	21, 24, 41, 46
33 Drip Pans Electric Coil models only.	6, 48
34 Surface Units Electric Coil models only.	2, 6, 7, 10, 12–15, 48
35 Lift-Up Cooktop Electric Coil models only.	47, 48
36 Halogen Surface Units	7, 10–17, 47

*Not all features are on all models.







HOW DOES THIS COOKTOP COMPARE TO YOUR OLD ONE?

Your new cooktop has either electric coil surface units or a halogen/radiant glass cooktop. If you are used to cooking with gas burners or other types of electric cooktops, you will notice some differences when you use electric coils or a halogen/radiant glass cooktop.

The best types of cookware to use, plus heat-up and cool-down times, depend upon the type of burner or surface unit you have.

The following chart will help you to understand the differences between your new cooktop and any other type of cooktop you may have used in the past.

Type of Cooktop	Description	How it Works
Electric Coil 	Flattened metal tubing containing electric resistance wire suspended over a drip pan.	Heats by direct contact with the pan and by heating the air under the pan. For best cooking results, use good quality pans. Electric coils are more forgiving of warped pans than halogen/radiant or solid disks. Heats up quickly but does not change heat settings as quickly as gas or induction. Electric coils stay hot enough to continue cooking for a short time after they are turned off.
Halogen/Radiant (Glass Cooktop) 	Radiant: Electric coils under a glass cooktop. Halogen: Quartz tube filled with halogen gas around a tungsten wire heating element under a glass cooktop.	Heat travels to the glass surface and then to the cookware, so pans must be flat on the bottom for good cooking results. The glass cooktop stays hot enough to continue cooking long after it is turned off. Remove the pan from the surface unit if you want cooking to stop.
Induction 	High frequency induction coils under a glass surface.	Pans must be made of ferrous metals (metal that attracts a magnet). Heat is produced by a magnetic circuit between the coil and the pan. Heats up right away and changes heat settings right away, like a gas cooktop. After turning the control off, the glass cooktop is hot from the heat of the pan, but cooking stops right away.
Solid Disk 	Solid cast iron disk sealed to the cooktop surface.	Heats by direct contact with the pan, so pans must be flat on the bottom for good cooking results. Heats up and cools down more slowly than electric coils. The disk stays hot enough to continue cooking after it is turned off. Remove the pan from the solid disk if you want the cooking to stop.
Gas Burners 	Regular or sealed gas burners use either LP gas or natural gas.	Flames heat the pans directly. Pan flatness is not critical to cooking results, but pans should be well balanced. Gas burners heat the pan right away and change heat settings right away. When you turn the control off, cooking stops right away.



General Information About Halogen/Radiant Surface Units

The halogen/radiant cooktop features heating units beneath a smooth glass surface. The surface units are shown by outlines on the glass.

Before you use the cooktop for the first time, clean it with cleaning cream. This helps protect the top and makes clean-up easier.

NOTE: A slight odor is normal when a new cooktop is used for the first time. It is caused by the heating of new parts and insulating materials and will disappear in a short time.

When a surface unit is turned on, coils beneath the surface unit radiate heat through the glass to the cookware. The red glow of the coils will be visible through the glass. It will take the surface unit a few moments to heat up. The coil cycles on and off to maintain your selected control setting. With poor cookware, you will see frequent cycling of the unit off and on. Good, flat cookware will minimize the cycling.

Use only flat-bottomed cookware. Do not let pots boil dry. Overheated metal can bond to glass cooktop. An overheated copper pot will leave a residue that will permanently stain the glass.

Sliding aluminum cookware across the glass may leave metal marks. These metal marks will appear as small scratches. They can be removed with cleaning cream and a razor scraper.

It is safe to place hot cookware from the oven or surface on the glass surface when the surface is cool.

Avoid sliding pans on the glass cooktop. Pan edges that are even slightly rough or grit on the cooktop can cause scratches on the glass.

Even after the surface units are turned off, the glass cooktop retains enough heat to continue cooking. To avoid overcooking, remove pans from the surface units when the food is cooked. Avoid placing anything on the surface unit until it has cooled completely.

The Hot Surface Lights will stay lit until the cooktop is safe to touch. It is not unusual for the lights to stay lit for 30 minutes.

Differences Between Halogen and Radiant Units

Some cooktops have both radiant and halogen surface units. This is how they differ.

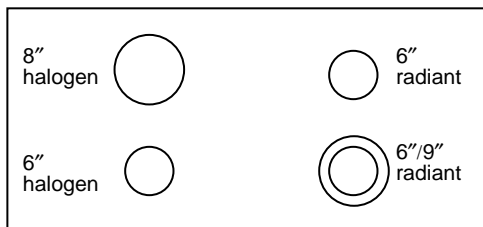

• Halogen units click when they cycle on and off. Radiant units do not. This is due to the different switches used on halogen units.

• Halogen units have radiant coils in the center that do not glow as brightly as the outer halogen coils.

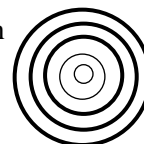

• Radiant coils take about 10 seconds longer to glow than halogen units.

- Halogen units are much **brighter** than the radiant units. Radiant units have a dull red glow.
- Halogen units **hum** louder than radiant units when they are first turned on.
- Halogen and radiant units **cycle** on and off frequently. This is normal. You will notice the cycling more on the halogen units because of their brightness.



HOME CANNING TIPS

Canning should be done on the surface units only.

Pots that extend beyond 1 inch of the surface unit are not recommended for most surface cooking. However, when canning with water-bath or pressure canner, larger-diameter pots may be used. This is because boiling water temperatures (even under pressure) are not harmful to the cooktop surfaces surrounding the surface units.

HOWEVER, DO NOT USE LARGE DIAMETER CANNERS OR OTHER LARGE DIAMETER POTS FOR FRYING OR BOILING FOODS OTHER THAN WATER. Most syrup or sauce mixtures—and all types of frying—cook at temperatures much higher than boiling water. Such temperatures could eventually harm the porcelain cooktop surfaces surrounding the electric coil surface units.

Observe the Following Points in Canning

1. Be sure the canner fits over the center of the surface unit. If your range or its location does not allow the canner to be centered on the surface unit, use smaller diameter pots for good canning results.
2. For best results, use canners with flat bottoms. On the glass cooktop, flat bottomed canners **must** be used. Canners with flanged or rippled bottoms (often found in enamelware) don't make good contact with the surface unit and take a long time to boil water.



Flat-bottomed canners are recommended for electric coils; they are *required* for glass cooktops.

3. When canning, use recipes and procedures from reputable sources. Reliable recipes and procedures are available from the manufacturer of your canner; manufacturers of glass jars for canning, such as Ball and Kerr; and the United States Department of Agriculture Extension Service.
4. Remember that canning is a process that generates large amounts of steam. To avoid burns from steam or heat, be careful when canning.

NOTE: If your house has low voltage, canning may take longer than expected, even though directions have been carefully followed.

The process time can be shortened by:

- (1) using a pressure canner, and
- (2) starting with **HOT** tap water for fastest heating of large quantities of water.

Glass Cooktop Cautions:

Safe canning requires that harmful microorganisms are destroyed and that the jars are sealed completely. When canning foods in a water-bath canner, a gentle but steady boil must be maintained for the required time. When canning foods in a pressure canner, the pressure must be maintained for the required time.

After you have adjusted the controls, it is very important to make sure the prescribed boil or pressure levels are maintained for the required time.

The glass cooktop surface units have temperature limiters that prevent the glass cooktop from getting too hot. If the bottom of your canner is not flat, the surface unit can overheat, triggering the temperature limiters to cycle the unit off for a time. This will stop the boil or reduce the pressure in the canner.

Since you must make sure to process the canning jars for the prescribed time, with no interruption in processing time, you cannot can on any of the cooktop surface units if your canner is not flat enough.

What is a Temperature Limiter?

Every halogen and radiant surface unit has a Temperature Limiter. The Temperature Limiter protects the glass cooktop from getting too hot.

The Temperature Limiter may cycle the units off for a time if:

- The pan boils dry.
- The pan bottom is not flat.
- The pan is off center.
- There is no pan on the unit.

SURFACE CONTROLS



At both OFF and HI the control “clicks” into position. You may hear slight “clicking” sounds during cooking, indicating the control is keeping the unit at the heat level or power level you set.

Switching heats to higher settings always shows a quicker change than switching to lower settings.

How to Set the Controls

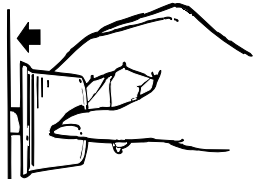

Push the knob in and turn in either direction to the desired heat setting.

Be sure you turn the control knob to OFF when you finish cooking.

The surface unit “on” indicator light will glow when ANY surface unit is on.

Cooking Guide for Using Heat Settings

HI—Used to begin cooking or to bring water to a boil. Reduce heat setting after water boils.

Medium High—(Setting halfway between HI and MED) Maintains a fast boil on large amounts of food.

MED—Sauté and brown; keeps food at a medium boil.

Medium Low—(Setting halfway between MED and LO) Cook after starting at HI; cooks with little water in covered pan.

LO—Used for long slow cooking (simmering) to tenderize and develop flavors. Use this setting to melt butter and chocolate or to keep foods warm.

NOTE: The surface unit “on” indicator light may glow between LO and OFF, but there is no power to the surface units.

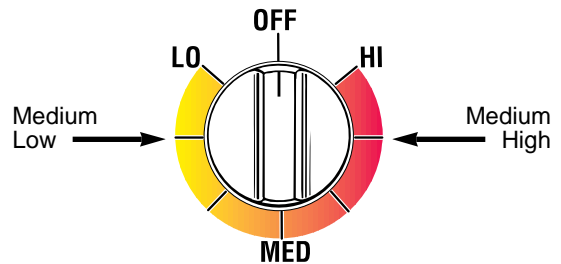

Appearance may vary slightly.

Light Over the Surface Units

The switch must be pushed, held for several seconds and released for the light to come on.

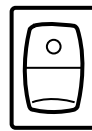

Special Notes for Glass Cooktops:

Cooktop temperatures increase with the number of surface units that are on. With 3 or 4 units turned on, surface temperatures are high so be careful when touching the cooktop. The hot surface indicator light will remain lit after the surface unit is off until the surface is cool enough to touch.

NOTE:

- At HI and Medium High settings never leave food unattended. Boilovers cause smoking and greasy spillovers may catch fire.
- At Medium Low and LO settings melt chocolate and butter on a small surface unit.

- When a surface unit is turned on, the unit can be seen glowing red within a few seconds (longer for radiant units). The red glow will turn on and off (cycling) to maintain the selected heat setting. With poor cookware, you will see frequent cycling of the unit off and on. Good, flat cookware will minimize the cycling. See the Surface Cookware Tips section.
- It is safe to place hot cookware from the oven or a surface unit on the glass cooktop when it is cool.

(continued next page)



SURFACE CONTROLS

(continued)

Dual Surface Unit Switch (Glass Cooktops Only)

The right front surface unit has 2 cooking sizes to select from so you can match the size of the unit to the size of the cookware you are using.

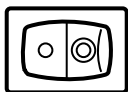

To use the **large** (9 inch) surface unit, push in the **right** portion of the COIL SIZE switch next to the control knob.

To use the **small** (6 inch) surface unit, push in the **left** portion of the COIL SIZE switch.

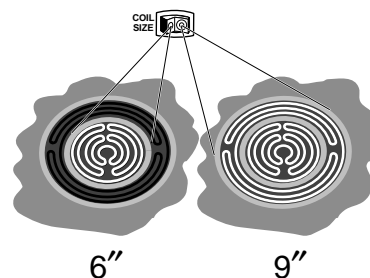
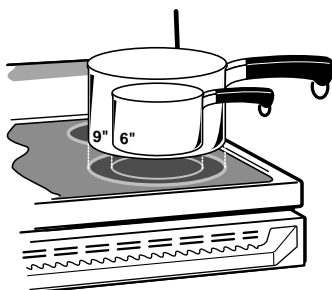

Hot Surface Indicator Light (Glass Cooktops Only)

A “HOT SURFACE” light will glow brightly when any element is turned on, and will remain lit after the unit is turned off until the surface is cool enough to touch. Each element has its own “HOT SURFACE” indicator light.

- It comes on instantly when the unit is turned on.
- It stays on even after the unit is turned off.
- It glows brightly until the unit is safe to touch.

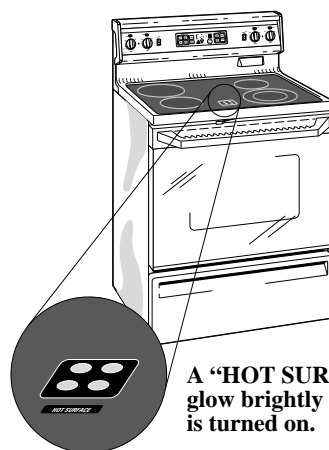

A “HOT SURFACE” light will glow brightly when any element is turned on.

SURFACE COOKWARE TIPS

(Electric Coil models only)

Cookware

Use medium- or heavy-weight cookware. Aluminum cookware conducts heat faster than other metals. Cast-iron and coated cast-iron cookware are slow to absorb heat, but generally cook evenly at low to medium heat settings. Steel pans may cook unevenly if not combined with other metals.

For best cooking results pans should be flat on the bottom. Match the size of the saucepan to the size of the surface unit. The pan should not extend over the edge of the surface unit more than 1 inch.

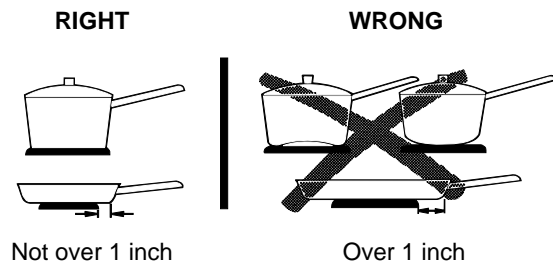



Wok Cooking

We recommend that you use only a flat-bottomed wok. They are available at your local retail store.



Do not use woks that have support rings. Use of these types of woks, with or without the ring in place, can be dangerous. Placing the ring over the surface unit will cause a build-up of heat that will damage the porcelain cooktop. Do not try to use such woks without the ring. You could be seriously burned if the wok tipped over.

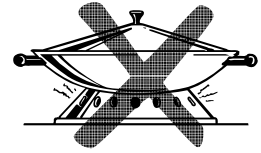

Do not use woks that have support rings.

SURFACE COOKWARE TIPS

(Glass Cooktop models only)

Types of Cookware

The following information will help you choose cookware which will give good performance.

Stainless Steel: *highly recommended*

Especially good with a sandwich clad bottom. The sandwich bottom combines the benefits of stainless steel (appearance, durability and stability) with the advantages of aluminum or copper (heat conduction, even heat distribution).

Aluminum: *heavy weight recommended*

Good conductivity. Aluminum residues sometimes appear as scratches on the cooktop, but can be removed if cleaned immediately. Because of its low melting point, thin weight aluminum should not be used.

Porcelain/enamel:

Good performance only with a thick, flat, smooth bottom. Avoid boiling dry, as porcelain can melt and fuse to the surface.

Copper Bottom: *heavy weight recommended*

Good performance, but copper may leave residues which can appear as scratches. The residues can be removed, as long as the cooktop is cleaned immediately. However, do not let these pots boil dry. Overheated metal can bond to glass cooktops. An overheated copper pot will leave a residue that will permanently stain the cooktop.

Glass-ceramic: *not recommended*

Poor performance. May scratch surface. Usable, but not recommended.

Stoneware: *not recommended*

Poor performance. May scratch the surface. Usable, but not recommended.

Cast Iron: *not recommended*

Poor performance. May scratch the surface. Usable, but not recommended.

(continued next page)



SURFACE COOKWARE TIPS

(Glass Cooktop models only—continued)

How to Check Pan Performance

Use of correct cookware can affect the cooking performance and cleaning of your cooktop.

The correct cookware reduces the temperature of the cooktop surface and minimizes the chance of spillovers burning onto the cooktop.

You must use pans with perfectly flat bottoms.

Some pans may have curved or rounded bottoms or may be warped. If you are unsure of the flatness of your pans you may do this quick test.

Turn your pan upside down on the countertop, place a ruler flat against the pan surface. The bottom of the pan and the straight edge of the ruler should fit flush against each other all the way across. Turn the ruler a full 360 degrees, checking for any space between the ruler and the bottom of the pan.

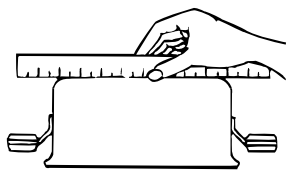

Pans with rounded, curved, ridged or warped bottoms are not recommended.

Another simple test to determine even heat distribution across the cookware bottom is to put one inch of water in the pan. Bring the water to a boil and observe the location of bubbles as the water starts to boil. Good flat cookware will have an even distribution of bubbles over the bottom surface area of the pan. Bubbles localized in only a portion of the bottom indicate uneven contact of the pan to the surface unit, uneven heat transfer or an unsuitable pan.

Use pans that match the diameter of the surface unit. Cooking performance will not be as good if the cookware is either smaller or larger than the surface unit.

• Place only dry pans on the surface units. Do not place lids on the surface units, particularly wet lids.

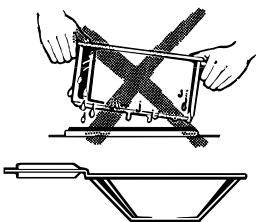

• We recommend that you use only a flat-bottomed wok. They are available at your local retail store. The bottom of the wok should have the same diameter as the surface unit to insure proper contact.

• Do not use woks that have support rings. This type of wok will not heat on glass cooktops.



• Some special cooking procedures require specific cookware such as pressure cookers, deep fat fryers, etc. All cookware must have flat bottoms and be the correct size.

SPECIAL CAUTIONS FOR GLASS COOKTOPS



• Never cook directly on the glass. Always use cookware.



• Do not use the surface as a cutting board.



• Don't store heavy items above the cooktop. If they drop onto the cooktop, they can cause damage.



• Always place the pan in the center of the surface unit you are cooking on.



• Do not slide cookware across the cooktop because it can scratch the glass—the glass is scratch resistant, not scratch proof.

HALOGEN/RADIANT SURFACE CLEANING

(on some models)

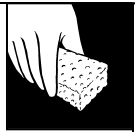

Glass Cooktop Cleaning

Cleaning of glass cooktops is different from cleaning a standard porcelain finish. To maintain and protect the surface of your new glass cooktop follow these basic steps.

Before you use the cooktop for the first time, clean it with cleaning cream. This helps protect the top and makes clean-up easier.

DAILY CLEANING: Use only a recommended cleaning cream, such as Cerama Brite or the Cooktop Cleaning Creme, on the glass cooktop.

For normal, light soil:

1. Rub a few drops (less is better) of the cleaning cream onto soiled area using a damp paper towel. Buff with a dry paper towel until all soil and cream are removed. Frequent cleaning leaves a protective coating which is essential in preventing scratches and abrasions.
2. Clean the surface with the cleaning cream after each use.

For heavy, burned on soil:

1. Apply a few drops of the cleaning cream to the (cool) soiled area.
2. Using a damp paper towel, rub the cream into the burned on area. As with any burned on spill, this may require some effort.
3. Carefully scrape soil with razor scraper. Hold scraper at a 30° angle against the glass cooktop.
4. If any soil remains, repeat the steps listed above. For additional protection, after all soil has been removed, polish the entire surface with the cleaning cream.
5. Buff with a dry paper towel.

NOTE:

- Using a razor scraper will not damage the surface if the 30° angle is maintained.
- Be sure to use a new, sharp razor scraper. Do not use a dull or nicked blade.
- **Store the razor scraper out of reach of children.**

SPECIAL CARE: Sugary spillovers (such as jellies, fudge, candy syrups) or **melted plastics** can cause pitting of the surface of your cooktop (not covered by the warranty) unless the spill is removed while still hot. **Special care should be taken when removing hot substances.** Follow these instructions carefully and remove soil while spill is still hot.

1. Turn off all surface units affected by the spillover. Remove hot pans.
2. Wearing an oven mitt, hold the razor scraper at a 30° angle to the cooktop and scrape hot spill to a cool area outside the surface unit.
3. With the spill in a cool area, use a dry paper towel to remove any excess. Any spillover remaining should be left until the surface of the cooktop has cooled. Do not continue to use the soiled surface unit until all of the spillover has been removed. Follow the steps under Heavy Soil to continue the cleaning process.

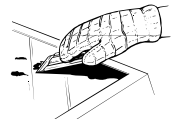

COOKTOP SEAL: To clean the cooktop seal, let a wet cloth rest on it for a few minutes, then wipe clean. Use a mild detergent if needed. Do not use a knife or any sharp object on the seal because it will cut or damage it.

GENERAL INFORMATION: As the cleaning cream cleans, it leaves a protective coating on the cooktop surface. This coating helps to prevent build-up of mineral deposits (water spots) and will make future cleaning easier. Dishwashing detergents remove this protective coating and therefore make the cooktop more susceptible to staining.

To conveniently order more cream and/or scrapers for cleaning your glass cooktop, please call our toll free number:

National Parts Center	800-626-2002
Cleaner	# WX10X300
Scraper	# WX5X1614
Cream and scraper kit	# WB64X5027

PRECAUTIONS

- If pots with a thin overlay of aluminum, copper or enamel are allowed to boil dry, the overlay may bond with the glass cooktop and leave a black discoloration. This should be removed immediately before heating again or the discoloration may be permanent.
- Water stains (mineral deposits) are removable using the cleaning cream or full strength white vinegar.
- Use of window cleaner may leave an iridescent film on the cooktop. The cleaning cream will remove this discoloration.

- If you slide **aluminum or copper cookware** across the surface of your cooktop, they may leave **metal markings which appear as scratches**. If this should happen, use the razor scraper and cleaning cream to remove these markings. Failure to remove these residues immediately may leave permanent marks.
- Most cleaners contain ammonia, chemicals and abrasives which can damage the surface of your cooktop. **Use only the recommended cleaning cream for proper cleaning and protection of your glass cooktop.**

Read and follow all instructions and warnings on the cleaning cream labels.



FEATURES OF YOUR OVEN CONTROL

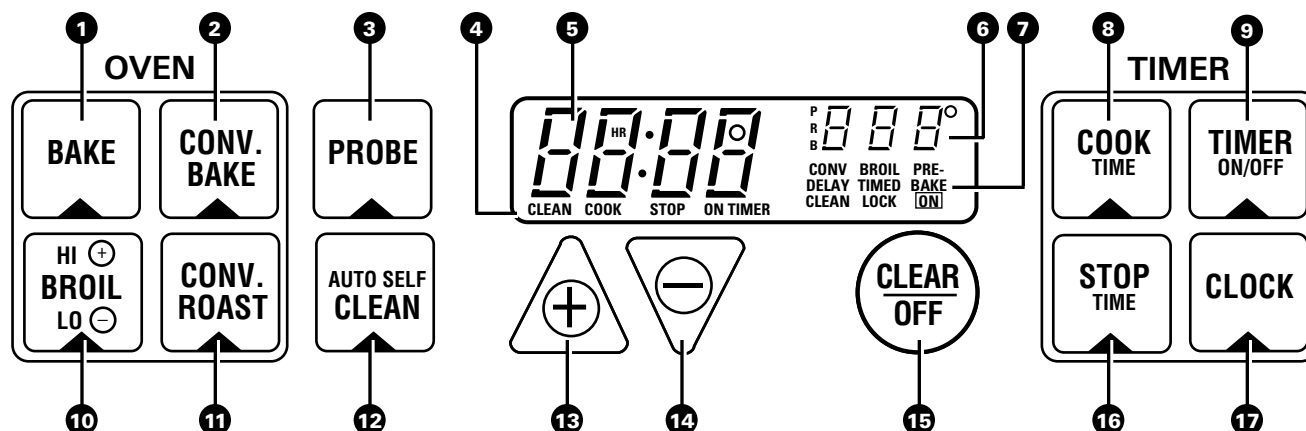

- 1. BAKE.** Press this pad to select the bake function.
- 2. CONV. BAKE.** Press this pad to select baking with convection.
- 3. PROBE.** Press this pad when using the probe to cook food.
- 4. PROGRAM STATUS.** Words light up in the display to indicate what is in time display.
Programmed information can be displayed at any time by pressing the pad of the operation you want to see. For example, you can display the current time of day while the timer is counting down by pressing the CLOCK pad.
- 5. TIME DISPLAY.** Shows the time of day, the times set for the timer or automatic oven operation.
- 6. OVEN OR PROBE TEMPERATURE AND BROIL DISPLAY.** Shows the oven temperature, probe temperature or broil setting.
- 7. FUNCTION INDICATORS.** Words light up to show whether the oven is in the bake, broil, convection bake, self-clean mode or set mode or if the probe is selected.
- 8. COOK TIME.** Use this pad for Timed Baking, Timed Convection Baking and Timed Convection Roasting operations.
- 9. TIMER ON/OFF.** Press this pad to select the timer function. The timer does not control oven operations. The timer can time up to 9 hours and 55 minutes.
To set the timer, first press the TIMER ON/OFF pad. Then press the + or – pad to change the time.
To cancel the timer, press and hold the TIMER ON/OFF pad until the word “TIMER” disappears from the display.
- 10. BROIL.** Press this pad to select the broil function.
- 11. CONV. ROAST.** Press this pad to select roasting with convection.
- 12. AUTO SELF CLEAN.** Press this pad to select the self-cleaning function. See the Operating the Self-Cleaning Oven section.
- 13. INCREASE (+).** Short taps to this pad increase the time or temperature by small amounts. Press and hold the pad to increase the time or temperature by larger amounts.
- 14. DECREASE (–).** Short taps to this pad decrease the time or temperature by small amounts. Press and hold the pad to decrease the time or temperature by larger amounts.
- 15. CLEAR/OFF.** Press this pad to cancel all oven operations except Clock and Timer.
- 16. STOP TIME.** Use this pad along with the COOK TIME or AUTO SELF CLEAN pad to set the oven to start and stop automatically at a time you select.
- 17. CLOCK.** To set the clock, first press the CLOCK pad. Then press the + or – pad to set the time of day. Press the CLOCK pad to start.

If “F—and a number” flash in the display and the oven control signals, this indicates function error code. If function error code appears during the self-cleaning function, check the oven door latch—the latch handle may have been moved, even if only slightly, from the latched position. Make sure handle is to the right as far as it will go. Press the CLEAR/OFF pad. Allow the oven to cool for one hour. If function error code repeats, disconnect power to the range and call for service.

OVEN CONTROL, CLOCK AND TIMER



Clock

The clock must be set for the automatic oven timing functions to work properly. The time of day cannot be changed during a Timed Baking or CLEAN cycle.

To Set the Clock



1. Press the CLOCK pad.

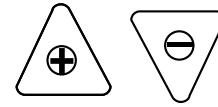

2. Press the + or – pad to set the time of day.
3. Press the CLOCK pad to start.

Timer

The timer is a minute timer; it does not control oven operations. The maximum setting on the timer is 9 hours and 55 minutes.

To Set the Timer



1. Press the TIMER ON/OFF pad.

2. Press the + or – pad to set the amount of time on the timer.

The timer will start automatically within a few seconds of releasing the + or – pad.

The timer, as you are setting it, will display hours and minutes. “HR” will be in the display.

During the countdown, when the timer reaches the last minute, the display will change to seconds only and a single beep will sound.

To Reset the Timer

If both “SET” and “TIMER” are displayed, press the + or – pad until desired time is reached.

If only “TIMER” is displayed, press the TIMER ON/OFF pad first, then follow the instructions above to set the timer.

To Cancel the Timer

Press and hold the TIMER ON/OFF pad until the word “TIMER” disappears from the display.

End of Cycle Tones

The end of cycle tone is a series of 3 beeps followed by 1 beep every 6 seconds. If you would like to remove the signal that beeps every 6 seconds, press and hold the CLEAR/OFF pad for 10 seconds.

To return the signal that beeps every 6 seconds, press and hold the CLEAR/OFF pad for 10 seconds.

Power Outage

After a power outage, when power is restored, the display will flash and time shown will no longer be correct—for example, after a 5-minute power interruption the clock will be 5 minutes slow.

All other functions that were in operation when the power went out will have to be programmed again.

Display Messages

Programmed information can be displayed at any time by pressing the pad of the operation you want to see. For example, you can display the current time of day while the timer is counting down by pressing the CLOCK pad. Press the TIMER ON/OFF pad to return to the timer display.

To check the start time for Delayed Bake or Self-Clean, press and hold the COOK TIME or AUTO SELF CLEAN pad for 3 seconds. The display will show the bake or clean start time for as long as you press the pad. When you release the pad, the display will return to the time of day.

If “door” appears in the display, LOCK flashes, and the oven control signals you set the self-clean cycle and did not shut the oven door.

(continued next page)



OVEN CONTROL, CLOCK AND TIMER

(continued)

INCREASE (+) and DECREASE (-) Pad Speed

You can change the speed of the + and – pads.

While the oven is off and the time of day shows in the display, press and hold the + and – pads and the TIMER ON/OFF pad at the same time for about 2 or 3 seconds.

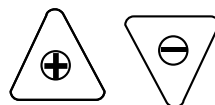

A number from 1 to 5 will replace “0:00” in the display. The slowest is 1 and the fastest is 5. Use the + or – pad to change the number, then press the CLEAR/OFF pad to return to the time of day display.

Child Lockout Feature

Your range has a special feature that allows you to lock the oven control preventing children from turning on the oven accidentally or without your permission.

To lock the oven control, press and hold the + and – pad and the STOP TIME pad at the same time for two seconds. The word “OFF” will appear and then disappear in the display and the oven control will be locked. During lockout, the word “OFF” will appear momentarily each time a cooking function pad is pressed.

To unlock the oven control, repeat the above procedure. The word “OFF” will appear in the display and then disappear after two seconds.

USING YOUR OVEN



Before Using Your Oven

1. Look at the controls. Be sure you understand how to set them properly. Read over the directions for the Oven Controls so you understand how to use them.
2. Check the oven interior. Look at the shelves. Take a practice run at removing and replacing them properly, to give sure, sturdy support.
3. Read over the information and tips that follow.
4. Keep this guide handy so you can refer to it, especially during the first weeks of using your new range.

Oven Light

The light comes on automatically when the oven door is opened.

Use the switch to turn the light on and off when the door is closed.

OVEN LIGHT

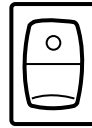

Offset Shelf

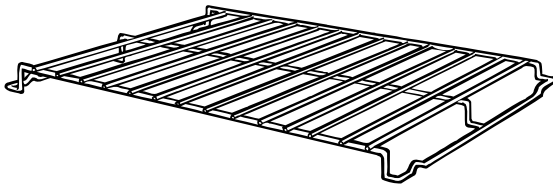

The offset shelf provides more cooking space between itself and the shelf below it. This allows more flexibility when placing foods in the oven. See the Multi-Shelf Baking section.

The offset shelf can be placed at any shelf position but be very careful if using it in the top position. Most foods will be too close to the broil unit in this position.

To remove the shelf, pull it forward to the stop-locks and lift the front of the shelf.

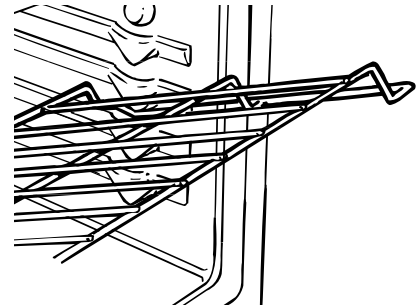

To replace the shelf, tilt the shelf up at the front and slide the curved extension of the shelf under the stop-locks on the shelf support. Then slide the shelf all the way into the oven.

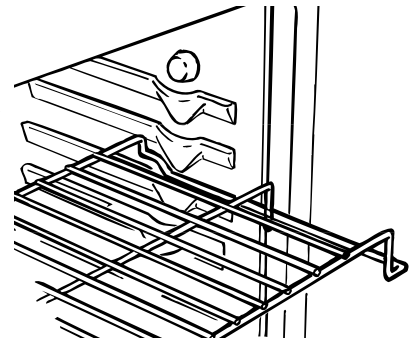

(continued next page)



USING YOUR OVEN

(continued)

Oven Shelves

The shelves are designed with stop-locks so that when placed correctly on the shelf supports, they will stop before coming completely out from the oven, and will not tilt when removing food from or placing food on them.

When placing cookware on a shelf, pull the shelf out to the bump on the shelf support. Place the cookware on the shelf, then slide the shelf back into the oven. This will eliminate reaching into the hot oven.

To remove a shelf from the oven, pull it toward you, tilt the front end upward and pull it out.

To replace, place the shelf on the shelf support with the stop-locks (curved extension of the shelf) facing up toward the rear of the oven. Tilt up the front and push the shelf toward the back of the oven until it goes past the bump on the shelf support. Then lower the front of the shelf and push it all the way back.

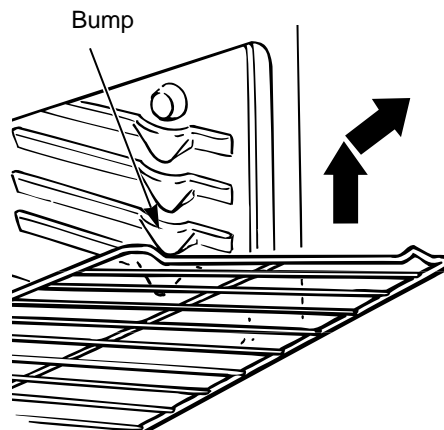

Shelf Positions

The oven has four shelf supports as identified in this illustration as A (bottom), B, C and D (top).

Shelf positions for cooking are suggested in the Baking, Roasting and Broiling sections.

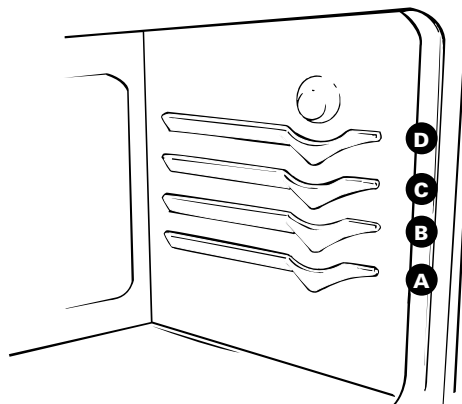

CONVECTION COOKING

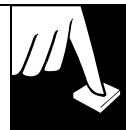

What is Convection?

In a convection oven, a fan circulates hot air over, under and around the food. This circulating hot air is evenly distributed throughout the oven cavity. As a result, foods are evenly cooked and browned—often in less time with convection heat.

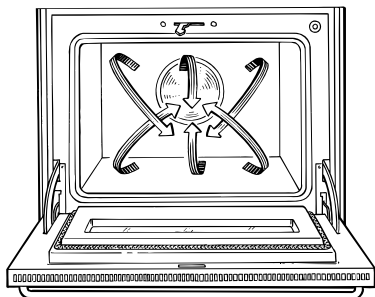

You can use your favorite recipes in the convection oven. Recipe conversion is as easy as 1, 2, 3.

1. When roasting, reduce normal roasting time by 25%.
2. When baking, reduce baking temperature by 25°F.
3. No need to preheat when cooking longer than 15 minutes.

CAUTION: The convection oven fan shuts off when the oven door is opened. DO NOT leave the door open for long periods of time while using convection cooking or you may shorten the life of the convection heating element.

When should you use Convection Bake or Convection Roast?

To help you understand the difference between convection bake and roast and traditional bake and roast, here are some general guidelines.

In convection bake, heat comes from the heating element in the rear of the oven. The convection fan circulates the heated air evenly, over and around the food. Preheating is not necessary with foods having a bake time of over 15 minutes.

In regular baking, the bottom heating element heats the air in the oven which then cooks the food.

Convection Bake

- Ideal for evenly browned baked foods cooked on all 3 shelves.
- Good for large quantities of baked foods.
- Good results with cookies, biscuits, muffins, brownies, cupcakes, cream puffs, sweet rolls, angel food cake and bread.

Regular Bake

- Foods such as layer cakes have a more level top crust when baked with traditional heat.

In convection roast, heat comes from the top heating element. The convection fan circulates the heated air evenly over and around the food. Meat and poultry are browned on all sides as if they were cooked on a rotisserie. Using the roasting rack provided, heated air will be circulated over, under and around the food being roasted. The heated air seals in juices quickly for a moist and tender product while, at the same time, creating a rich golden brown exterior.

Convection Roast

- Large tender cuts of meat, uncovered.
- Roasting pans with low sides to allow air movement around food.

Regular Roast

- Less tender cuts of meat because these need to cook a long time in liquid to become tender.
- Cooking bag
- Foil tent
- Covered dish

Cookware for Convection Cooking

Before using your convection oven, check to see if your cookware leaves room for air circulation in the oven. If you are baking with several pans, leave space between them. Also, be sure the pans do not touch each other or the walls of the oven.

Metal and Glass

Any type of cookware will work in your convection oven. However, metal pans heat the fastest and are recommended for convection baking.

- Darkened or matte-finished pans will bake faster than shiny pans.
- Glass or ceramic pans cook more slowly.

Paper and Plastic

Heat-resistant paper and plastic containers that are recommended for use in regular ovens can be used in convection ovens. Plastic cookware that is heat-resistant to temperatures of 400°F. can also be used.

When baking cookies, you will get the best results if you use a flat cookie sheet instead of a pan with low sides.

For recipes like oven-baked chicken, you should use a pan with low sides. Hot air cannot circulate well around food in a pan with high sides.



CONVECTION BAKING

Adapting Recipes For Convection Baking

As a general rule, reduce the temperature by 25°F for convection baking. For more specific instructions, follow the guidelines in the Convection Cookbook.

Preheating is not necessary with foods having a bake time of over 15 minutes.

Check foods for doneness at the minimum suggested cooking time.

Use pan size recommended in the recipe.

Some package instructions for frozen casseroles or main dishes have been developed using commercial convection ovens. For best results in this oven, preheat the oven and use the temperature on the package.

For more information on adapting recipes, see the Convection Cookbook.

Multi-Shelf Baking

Because heated air is circulated evenly throughout the oven, foods can be baked with excellent results on 2 or 3 shelves at a time. Multi-shelf baking may increase cook times slightly for some foods but the overall result is time saved. Cookies, muffins, biscuits, and other quickbreads give very good results with multi-shelf baking.

When baking on 3 shelves, divide the oven into thirds by placing the offset shelf in the second (B) shelf position and the straight shelves in first (A) and fourth (D) shelf position.

For 2-shelf baking, place the straight shelves in the A and C positions.

NOTE: When convection baking with only 1 shelf, follow the shelf positions recommended in the Oven Shelves section of the Regular Baking section.

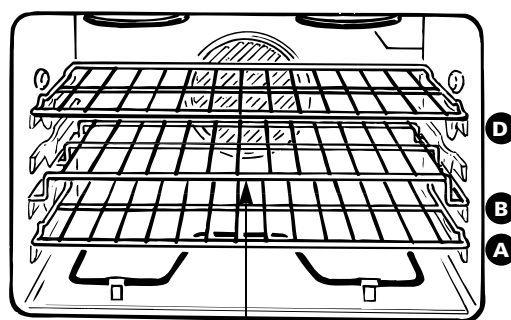

Offset shelf

How to Set Your Oven for Convection Baking

Do not lock the oven door with the latch during convection baking. The latch is used for self-cleaning only.

To avoid possible burns, place the shelves in the correct position before you turn the oven on.



1. Press the CONV. BAKE pad.

2. Press the + or – pad. The last oven set temperature appears in the display. Continue pressing until the desired temperature is displayed.

When the oven starts to heat, the word “ON” and the changing temperature, starting at 100°F., will be displayed. When the oven reaches the temperature you set, a tone will sound.



3. Press the CLEAR/OFF pad when baking is finished.

NOTE: You will hear a fan while cooking with this feature. The fan will stop when the door is opened but the heat will not turn off.

To change the oven temperature during the Convection Bake cycle, press the CONV. BAKE pad and then the + or – pad to get the new temperature.

TIMED CONVECTION BAKING

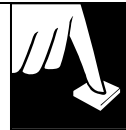

How to Convection Time Bake

Do not lock the oven door with the latch during timed convection baking. The latch is used for self-cleaning only.

Your oven can be set to turn on and off automatically.

NOTE: Before beginning, make sure the oven clock shows the correct time of day.



To set the clock, first press the CLOCK pad. Press the + or – pad until correct time of day is displayed. Press the CLOCK pad to start.

How to Set Immediate Start and Automatic Stop Convection Bake

To avoid possible burns, place the oven shelves in the correct position before you turn the oven on.

The oven will turn on immediately and cook for a specific length of time. At the end of Cook Time, the oven will turn off automatically.



1. Press the CONV. BAKE pad.



2. Press the + or – pad until the desired temperature is displayed.



3. Press the COOK TIME pad.



4. Press the + pad until the desired length of baking time appears in the display. The minimum Cook Time you can set is 10 minutes.

The words “TIMED CONV BAKE ” and “COOK TIME” will be displayed along with the oven temperature that you set and the cook time that you entered. When the oven starts to heat, the word “ON” and the changing temperature, starting at 100°F, will be displayed. When the oven reaches the temperature you set, a tone will sound. The oven will continue to cook for the programmed amount of time, then shut off automatically.



5. At the end of Timed Convection Bake the display will show “0HR:00 COOK TIME” and the oven will turn off. The end of cycle tone will sound. Press the CLEAR/OFF pad to clear the display if necessary.

6. Remove the food from the oven. Remember, foods that are left in the oven continue cooking after the controls are off.

NOTE:

- You will hear a fan while cooking with this feature. The fan will stop when the door is opened but the heat will not turn off.
- Foods that spoil easily such as milk, eggs, fish, stuffings, poultry and pork should not be allowed to sit for more than one hour before or after cooking. Room temperature promotes the growth of harmful bacteria. Be sure that oven light is off because heat from the bulb will speed harmful bacteria growth.

(continued next page)



How to Set Delay Start and Automatic Stop Convection Bake

Quick Reminder

1. Press the CONV. BAKE pad.
2. Press the + or – pad to select the oven temperature.
3. Press the COOK TIME pad.
4. Press the + or – pad to set the length of Cooking Time.
5. Press the STOP TIME pad.
6. Press the + or – pad until the desired Stop Time appears in the display.

To avoid possible burns, place the shelves in the correct position before you program the oven.

You can set the oven control to delay-start the oven, cook for a specific length of time and then turn off automatically.

For example: Let's say it's 2:00 and dinner time is shortly after 7:00. The recipe suggests 3 hours baking time at 325°F. Here's how:



1. Press the CONV. BAKE pad.



2. Press the + or – pad until "325°" is displayed.



3. Press the COOK TIME pad.



4. Press the + pad until "3HR:00" appears in the display. A Cook Time of 3 hours now appears in the display.



5. Press the STOP TIME pad. The display prompts you to set the Stop Time you want. It also shows the earliest Stop Time you can set. In this example, "5:00" and "COOK STOP TIME" appear in the display.

The control automatically sets the Stop Time by adding the Cook Time to the time of day. In this example, the time of day is 2:00 and the Cook Time is 3 hours. Adding 3 hours to the time of day equals 5:00.



6. Change the Stop Time from 5:00 to 7:00 by pressing the + pad until "7:00" appears in the display. The words "DELAY TIMED CONV BAKE" and "STOP TIME" appear in the display.

At 4:00, the oven will turn on automatically. When the oven starts to heat, the word "ON" and the changing oven temperature, starting at 100°F., will be displayed. The oven will continue to cook for the programmed 3 hours and shut off automatically at 7:00.

7. At the end of Timed Convection Bake, the display will show "0HR:00, COOK TIME" and the oven will turn off. The end of cycle tone will sound.



8. Press the CLEAR/OFF pad to clear the display if necessary. Remove the food from the oven. Remember, even though the oven shuts off automatically, foods continue cooking after the controls are off.

NOTE:

- You will hear a fan while cooking with this feature. The fan will stop when the door is opened but the heat will not turn off.
- Foods that spoil easily such as milk, eggs, fish, stuffings, poultry and pork should not be allowed to sit for more than one hour before or after cooking. Room temperature promotes the growth of harmful bacteria. Be sure that the oven light is off because heat from the bulb will speed harmful bacteria growth.

CONVECTION ROASTING



Meats cooked in a convection oven are dark brown on the outside and tender and juicy on the inside. In most cases, cooking time will be less when using the Convection Roast feature. Sometimes cooking time is reduced by 10 minutes per hour.

To make sure the meat is cooked the way you want it, we recommend using the temperature probe provided with the oven.

The special roasting rack and pan allow heated air to circulate over and under the meat. This allows the meat to brown on all sides.

Adapting Recipes for Convection Roasting

Use the temperature recommended in the Convection Roasting Guide.

Preheating is not necessary.

Check foods for doneness at the minimum suggested time.

Use the special roasting rack with the broiler pan and grid.

For more information on adapting recipes, see the Convection Cookbook.

Convection Roasting Rack

Roasts or poultry should be cooked on the lowest shelf position (A) on a shelf.

When you are convection roasting you will use the broiler pan and grid and the special roasting rack.

The pan is used to catch grease spills and the grid is used to prevent grease splatters. The rack holds the meat.

This rack allows the heated air to circulate under the meat and increase browning on the underside of the meat or poultry.

1. Place the shelf in the lowest shelf position (A).
2. Place the grid on the broiler pan and put the roasting rack over them making sure the posts on the roasting rack fit into the holes in the broiler pan.
3. Place the meat on the special roasting rack.

See the Regular Roasting with the Probe section to insert the probe correctly.

NOTE: It is important that the broiler pan and grid be used with the roasting rack for best convection roasting results.

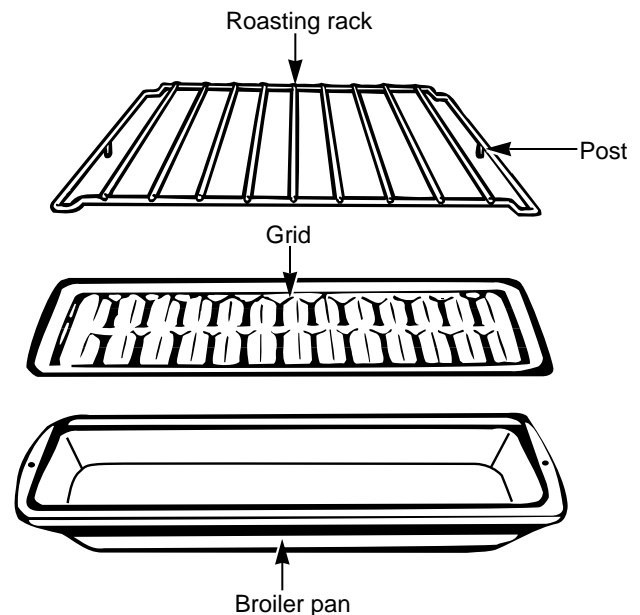

(continued next page)



CONVECTION ROASTING

(continued)

How to Set Your Oven for Convection Roasting When Using the Temperature Probe

NOTE: For best results when roasting large turkeys and roasts, we recommend using the probe included in the convection oven. For the correct placement of the probe, see the description in the Regular Roasting section.

Do not lock the oven door with the latch during convection roasting. The latch is used for self-cleaning only.

The display will flash “PROBE” and the oven control will signal if the probe is inserted into the outlet, but the oven is not programmed for the probe.

1. Place the shelf in the lowest position (A). Insert the probe into the meat.
2. Plug the probe into the outlet on the oven wall. Make sure it is pushed all the way in. Close the oven door.

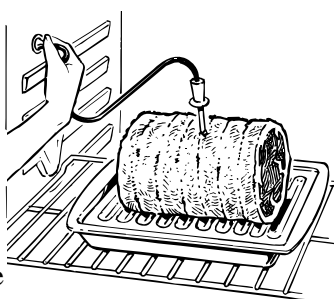

3. Press the PROBE pad.



4. Press the + or – pad until the desired internal probe temperature is displayed.

5. Press the CONV. ROAST pad.



6. Press the + or – pad. The last oven set temperature appears in the display. Continue pressing until the desired oven temperature is displayed.

When the oven starts to heat, the words “CONV ON” and the roasting temperature you set will be in the display.

After a few seconds, the words “LO PROBE” will replace the roasting temperature in the display.

After the internal temperature of the meat reaches 100°F., the changing internal temperature will be shown in the display.



7. When internal temperature of meat reaches the number you have set, the probe and the oven turn off and the oven control signals. To stop the signal, press the CLEAR/OFF pad. Use hot pads to remove the probe from the food. Do not use tongs to pull on it—they might damage it.

CAUTION: To prevent possible burns, do not unplug the probe from the oven outlet until the oven has cooled. Do not store the probe in the oven.

NOTE:

- If the probe is removed from the food before the final temperature is reached, a tone will sound and the display will flash until the probe is removed from the oven.
- You will hear a fan while cooking with this feature. The fan will stop when the door is opened but the heat will not turn off.
- You can use the timer even though you cannot use timed oven operations.

To change the oven temperature during the Convection Roast cycle, press the CONV. ROAST pad and then press the + or – pad to get the new desired temperature.

CONVECTION ROASTING GUIDE



Meats			Minutes/Lb.	Oven Temperature (°F.)	Internal Temperature (°F.)
Beef	Rib, Boneless Rib, Top Sirloin (3 to 5 lbs.)	Rare	20–24	325°	140°†
		Medium	24–28	325°	160°
		Well	28–32	325°	170°
	Beef Tenderloin	Rare	10–14	325°	140°†
		Medium	14–18	325°	160°
Pot Roast (2½ to 3 lbs.)	Chuck, Rump	35–45	300°	170°	
Pork	Bone-in, Boneless (3 to 5 lbs.)		23–27	325°	170°
	Chops (1/2 to 1-inch thick)	2 chops	30–35 total	325°	170°
		4 chops	35–40 total	325°	170°
		6 chops	40–45 total	325°	170°
Ham	Canned, Butt, Shank (3 to 5 lbs. fully cooked)		14–18	325°	140°
Lamb	Bone-in, Boneless (3 to 5 lbs.)	Medium	17–20	325°	160°
		Well	20–24	325°	170°
Seafood	Fish, whole (3 to 5 lbs.)		30–40 total	400°	
	Lobster Tails (6 to 8 oz. each)		20–25 total	350°	
Poultry	Whole Chicken (2½ to 3½ lbs.)		24–26	350°	180°–185°
	Cornish Hens	Unstuffed (1 to 1½ lbs.)	50–55 total	350°	180°–185°
		Stuffed (1 to 1½ lbs.)	55–60 total	350°	180°–185°
	Duckling (4 to 5 lbs.)		24–26	325°	180°–185°
	Turkey, whole*	Unstuffed (10 to 16 lbs.)	8–11	325°	180°–185°
		Unstuffed (18 to 24 lbs.)	7–10	325°	180°–185°
Turkey Breast (4 to 6 lbs.)		16–19	325°	170°	

*Stuffed birds generally require 30–45 minutes additional roasting time. Shield legs and breast with foil to prevent over browning and drying of skin.

†The U.S. Department of Agriculture says “Rare beef is popular, but you should know that cooking it to only 140°F. means some food poisoning organisms may survive.” (Source: *Safe Food Book. Your Kitchen Guide.* USDA Rev. June 1985.)

REGULAR BAKING

Do not lock the oven door with the latch during regular baking. The latch is used for self-cleaning only.

Your oven temperature is controlled very accurately using an oven control system. We recommend that you operate the oven for a number of weeks to become familiar with your new oven’s performance.

If you think an adjustment is necessary, see the Adjust the Oven Thermostat section. It gives easy *Do It Yourself* instructions on how to adjust the thermostat.

NOTE: When the oven is hot, the top and outside surfaces of the range get hot too.

How to Set Your Oven for Baking

To avoid possible burns, place the shelves in the correct position before you turn the oven on.

 1. Press the BAKE pad.

2. Press the + or – pad. The last oven set temperature appears in the display. Continue pressing until the desired temperature is displayed.

When the oven starts to heat, the word “ON” and the changing temperature, starting at 100°F., will be displayed. When the oven reaches the temperature you set, a tone will sound.



3. Press the CLEAR/OFF pad when baking is finished and then remove the food from the oven.

To change the oven temperature during the BAKE cycle, press the BAKE pad and then the + or – pad to get the new temperature.

(continued next page)



REGULAR BAKING

(continued)

Oven Shelves

Arrange the oven shelf or shelves in the desired locations while the oven is cool. The correct shelf position depends on the kind of food and the browning desired.

As a general rule, place most foods in the middle of the oven, on either shelf position B or C. See the chart for suggested shelf positions. B will be used more than C.

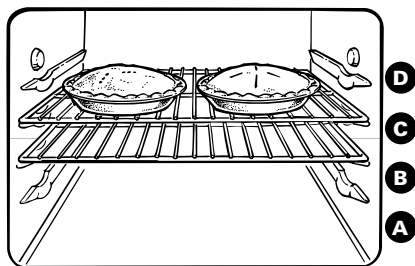

Type of Food	Shelf Position
Angel food cake	A
Biscuits or muffins	B or C
Cookies or cupcakes	B or C
Brownies	B or C
Layer cakes	B or C
Bundt or pound cakes	A or B
Pies or pie shells	B or C
Frozen pies	A (on cookie sheet)
Casseroles	B or C
Roasting	A or B

Preheating

Preheat the oven if the recipe calls for it. Preheat means bringing the oven up to the specified temperature before putting the food in the oven. To preheat, set the oven at the correct temperature—selecting a higher temperature does not shorten preheat time.

Preheating is necessary for good results when baking cakes, cookies, pastry and breads. For most casseroles and roasts, preheating is not necessary. For ovens without a preheat indicator light or tone, preheat 10 minutes. After the oven is preheated, place the food in the oven as quickly as possible to prevent heat from escaping.

Baking Pans

Use the proper baking pan. The type of finish on the pan determines the amount of browning that will occur.

- Dark, rough or dull pans absorb heat resulting in a browner, crisper crust. Use this type for pies.
- Shiny, bright and smooth pans reflect heat, resulting in a lighter, more delicate browning. Cakes and cookies require this type of pan.
- Glass baking dishes also absorb heat. When baking in glass baking dishes, the temperature may need to be reduced by 25°F.

Pan Placement

For even cooking and proper browning, there must be enough room for air circulation in the oven. Baking results will be better if baking pans are centered as much as possible rather than being placed to the front or to the back of the oven.

Pans should not touch each other or the walls of the oven. Allow 1- to 1½-inch space between pans as well as from the back of the oven, the door and the sides. If you need to use two shelves, stagger the pans so one is not directly above the other.

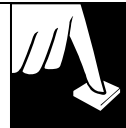

Baking Guides

When using prepared baking mixes, follow package recipe or instructions for the best baking results.

Cookies

When baking cookies, flat cookie sheets (without sides) produce better-looking cookies. Cookies baked in a jelly roll pan (short sides all around) may have darker edges and pale or light browning may occur.

Do not use a cookie sheet so large that it touches the walls or the door of the oven. Never entirely cover a shelf with a large cookie sheet.

For best results, use only one cookie sheet in the oven at a time.

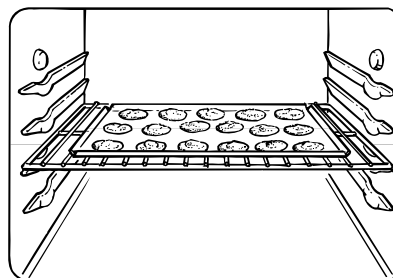

Pies

For best results, bake pies in dark, rough or dull pans to produce a browner, crisper crust. Frozen pies in foil pans should be placed on an aluminum cookie sheet for baking since the shiny foil pan reflects heat away from the pie crust; the cookie sheet helps retain it.

Cakes

When baking cakes, warped or bent pans will cause uneven baking results and poorly shaped products. A cake baked in a pan larger than the recipe recommends will usually be crisper, thinner and drier than it should be. If baked in a pan smaller than recommended, it may be undercooked and batter may overflow. Check the recipe to make sure the pan size used is the one recommended.

Aluminum Foil

Never entirely cover a shelf with aluminum foil. This will disturb the heat circulation and result in poor baking. A smaller sheet of foil may be used to catch a spillover by placing it on a lower shelf several inches below the food.

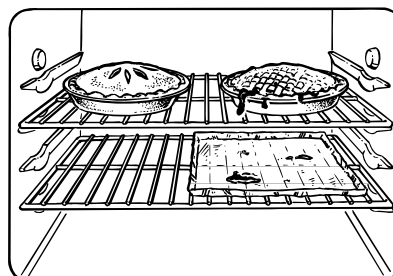

Don't Peek

Set the timer for the estimated cooking time and do not open the door to look at your food. Most recipes provide minimum and maximum baking times such as "bake 30-40 minutes."

DO NOT open the door to check until the minimum time. Take advantage of the "Big View" window to monitor cooking progress. Opening the oven door frequently during cooking allows heat to escape and makes baking times longer. Your baking results may also be affected.



REGULAR TIMED BAKING

How to Time Bake

Do not lock the oven door with the latch during regular timed baking. The latch is used for self-cleaning only.

Your oven can be set to turn on and off automatically.

NOTE: Before beginning, make sure the oven clock shows the correct time of day.



To set the clock, first press the CLOCK pad. Press the + or – pad until correct time of day is displayed. Press the CLOCK pad to start.

How to Set Immediate Start and Automatic Stop

To avoid possible burns, place the shelves in the correct position before you turn the oven on.

The oven will turn on immediately and cook for a selected length of time. At the end of Cook Time the oven will turn off automatically.



1. Press the BAKE pad.



2. Press the + or – pad until the desired temperature is displayed.



3. Press the COOK TIME pad.



4. Press the + or – pad until the desired length of baking time is displayed.

The words “TIMED BAKE” and “COOK TIME” will be displayed along with the oven temperature that you set and the cook time that you entered. When the oven starts to heat, the word “ON” and the changing temperature, starting at 100°F., will be displayed. When the oven reaches the temperature you set, a tone will sound. The oven will continue to cook for the programmed amount of time, then shut off automatically.

5. At the end of Timed Bake, the display will show “0HR:00 COOK TIME” and the oven will turn off. The end of cycle tone will sound.



6. Press the CLEAR/OFF pad to clear the display if necessary. Remove the food from the oven. Remember, foods that are left in the oven continue cooking after the controls are off.

NOTE: Foods that spoil easily such as milk, eggs, fish, stuffings, poultry and pork should not be allowed to sit for more than one hour before or after cooking. Room temperature promotes the growth of harmful bacteria. Be sure that oven light is off because heat from the bulb will speed harmful bacteria growth.

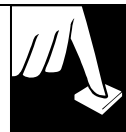

How to Set Delay Start and Automatic Stop

Quick Reminder:

1. Press the BAKE pad.
2. Press the + or – pad to select the oven temperature.
3. Press the COOK TIME pad.
4. Press the + or – pad to set the length of Cooking Time.
5. Press the STOP TIME pad.
6. Press the + or – pad until the desired Stop Time appears in the display.

To avoid possible burns, place the shelves in the correct position before you program the oven.

You can set the oven control to delay-start the oven, cook for a specific length of time and then turn off automatically.

For example: Let's say it's 2:00 and dinner time is shortly after 7:00. The recipe suggests 3 hours baking time at 325°F. Here's how:

1. Press the BAKE pad.
2. Press the + or – pad until “325°” is displayed.
3. Press the COOK TIME pad.
4. Press the + pad until “3HR:00” appears in the display. A Cook Time of 3 hours now appears in the display.

5. Press the STOP TIME pad. The display prompts you to set the Stop Time you want. It also shows the earliest Stop Time you can set. In this example, “5:00” and “STOP TIME” appear in the display. The control automatically sets Stop Time by adding the Cook Time to the time of day. In this example, the time of day is 2:00 and the Cook Time is 3 hours. Adding 3 hours to the time of day equals 5:00.
6. Change the Stop Time from 5:00 to 7:00 by pressing the + pad until “7:00” and Stop Time appear in the display. The words “DELAY TIMED BAKE” appear in the display. At 4:00, the oven will turn on automatically. When the oven starts to heat, the word “ON” and the changing temperature, starting at 100°F., will be displayed. The oven will cook for the programmed 3 hours and shut off automatically at 7:00.
7. At the end of Timed Baking, the display will show “0HR:00 COOK TIME” and the oven will turn off. The end of cycle tone will sound.
8. Press the CLEAR/OFF pad to clear the display if necessary. Remove the food from the oven. Remember, even though the oven shuts off automatically, foods continue cooking after the controls are off.

NOTE: Foods that spoil easily such as milk, eggs, fish, stuffings, poultry and pork should not be allowed to sit for more than one hour before or after cooking. Room temperature promotes the growth of harmful bacteria. Be sure that the oven light is off because heat from the bulb will speed harmful bacteria growth.

ADJUST THE OVEN THERMOSTAT—DO IT YOURSELF!

You may find that your new oven cooks differently than the one it replaced. We recommend that you use your new oven for a few weeks to become more familiar with it, following the times given in your recipes as a guide.

If you think your new oven is too hot or too cold, you can adjust the thermostat yourself. If you think it is too hot, adjust the thermostat to make it cooler. If you think it is too cool, adjust the thermostat to make it hotter.

We do not recommend the use of inexpensive thermometers, such as those found in grocery stores, to check the temperature setting of your new oven. These thermometers may vary 20–40 degrees.

The thermostat adjustment for Baking does not affect Convection Baking or Convection Roasting. To adjust these, press the CONV. BAKE or the CONV. ROAST pad instead of the BAKE pad when following the directions under To Adjust the Thermostat.

To Adjust the Thermostat:

1. Press the BAKE pad.
2. Select an oven temperature between 500°F. and 550°F.
3. Immediately, before “ON” appears, press and hold the BAKE pad for about 4 seconds. The time display will change to the oven adjustment display.
4. The oven temperature can be adjusted up to (+) 35°F. hotter or (–) 35°F. cooler. Use the + or – pad to select the desired change in the display.
5. When you have made the adjustment, press the CLEAR/OFF pad to go back to the time of day display. Use your oven as you would normally.

NOTE: This adjustment will not affect the broiling or self-cleaning temperatures. It will be retained in memory after a power failure.



REGULAR ROASTING

Do not lock the latch during regular roasting. The latch is used for self-cleaning only.

Roasting is cooking by dry heat. Tender meat or poultry can be roasted uncovered in your oven. Roasting temperatures, which should be low and steady, keep spattering to a minimum.

Roasting is really a baking procedure used for meats. Therefore, oven controls are set for Baking or Timed Baking. (You may hear a slight clicking sound, indicating the oven is working properly.) Timed Baking will turn the oven on and off automatically.

Most meats continue to cook slightly while standing, after being removed from the oven. Standing time recommended for roasts is 10 to 20 minutes. This allows roasts to firm up and makes them easier to carve. Internal temperature will rise about 5° to 10°F.; to compensate for temperature increase, if desired, remove the roast from the oven sooner (at 5° to 10°F. less than the temperature in the Regular Roasting Guide).

Remember that food will continue to cook in the hot oven and therefore should be removed when the desired internal temperature has been reached.

1. Place the shelf in A or B position. No preheating is necessary.
2. Check the weight of the meat. Place it, fat-side-up (or poultry breast-side-up) on a trivet in a shallow pan. The melting fat will baste the meat. Select a pan as close to the size of the meat as possible. (The broiler pan with grid is a good pan for this.)



3. Press the BAKE pad.

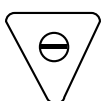

4. Press the + or – pad. The last oven set temperature appears in the display. Continue pressing the pad until the desired temperature is displayed.

When the oven starts to heat, the word “ON” and the changing oven temperature, starting at 100°F., will be displayed. When the oven reaches the temperature you set, a tone will sound.



5. Press the CLEAR/OFF pad when roasting is finished.

To change the oven temperature during roasting, press the BAKE pad and then the + or – pad to get the new temperature.

Use of Aluminum Foil

You can use aluminum foil to line the broiler pan. This makes clean-up easier when using the pan for marinating, cooking with fruits, cooking heavily cured meats or basting food during cooking. Press the foil tightly around the inside of the pan.

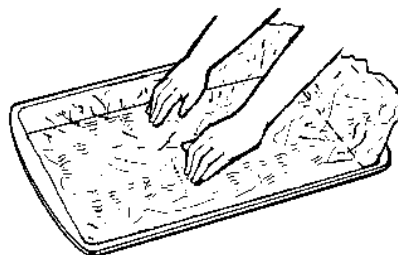

REGULAR ROASTING WITH THE PROBE

See the Regular Roasting Guide.



Correct Placement of the Temperature Probe

A temperature probe has been provided for use in your new oven. This probe is designed to withstand high temperatures. Temperature probes provided with other products, such as those used for microwave ovens, may not be designed to withstand high temperatures. Use of probes other than the one provided with this product may result in damage to the probe.

Never leave your probe inside the oven during a self-cleaning cycle.

For many foods, especially roasts and poultry, internal food temperature is the best test for doneness. The temperature probe takes the guesswork out of roasting by cooking foods to the exact doneness you want. When the internal temperature of the food reaches the temperature you set, the oven automatically shuts off.

The temperature probe has a skewer-like probe at one end and a plug at the other end that goes into the outlet on the oven wall.

Use the handles of the probe and plug when inserting and removing them from the meat and wall outlet. Do not use tongs to pull on the cable when removing the probe—they might damage it. **TO AVOID BREAKING THE PROBE, MAKE SURE FOOD IS COMPLETELY DEFROSTED BEFORE INSERTING.**

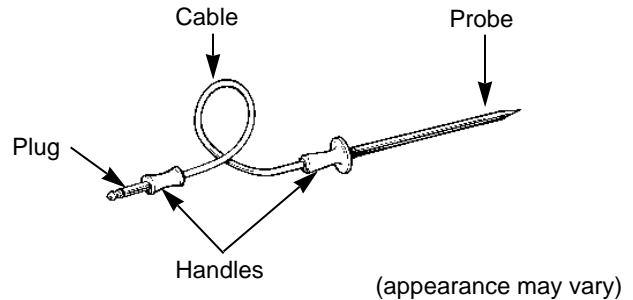

After preparing the meat and placing it on a trivet or on the broiler pan grid, follow these directions for proper probe placement.

1. Lay the probe on the outside of the meat along the top or side and mark with your finger where the edge of the meat comes to on the probe. The point should rest in the center of the thickest meaty part of the roast.

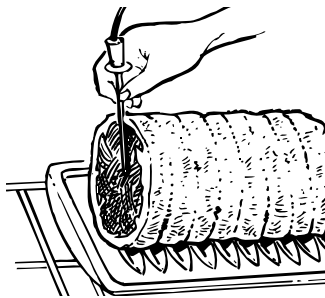

2. Insert the probe into the meat up to the point marked off with your finger. It should not touch the bone, fat or gristle.

No more than 2 inches of the probe, not counting the handle, should be left exposed outside the meat.

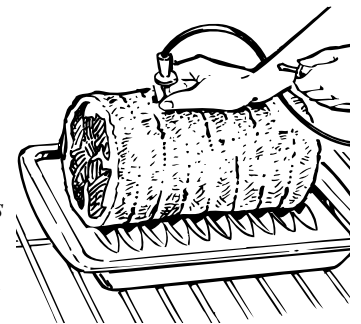

Ham or Lamb

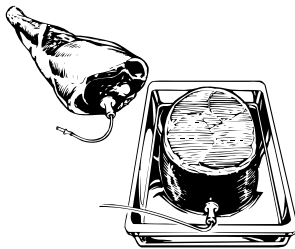

For roasts with no bone, insert the probe into the meatiest part of the roast. For bone-in ham or lamb, insert the probe into the center of the lowest large muscle or joint.

Casseroles or Fish

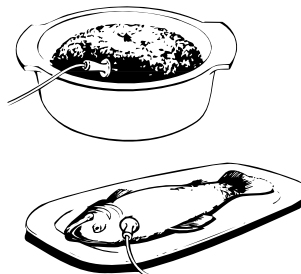

Insert the probe into the center of dishes such as meat loaf or casseroles. When cooking fish, insert the probe from just above the gill into the meatiest area, parallel to the backbone.

Poultry

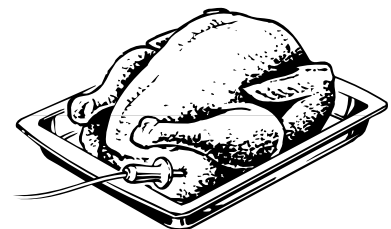

Insert the probe into the meatiest part of the inner thigh from below and parallel to the leg of a whole turkey.

(continued next page)



REGULAR ROASTING WITH THE PROBE

(continued)

How to Set the Oven When Using the Temperature Probe

The display will flash “PROBE” and the oven control will signal if the probe is inserted into the outlet, but the oven is not programmed for the probe.

1. Insert the probe into the meat.
2. Plug the probe into the outlet on the oven wall. Make sure it's pushed all the way in. Close the oven door.

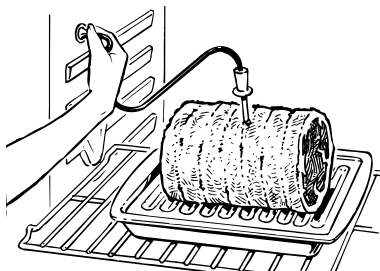

3. Press the PROBE pad.



4. Press the + or – pad until the desired internal probe temperature is displayed.



5. Press the BAKE pad.



6. Press the + or – pad. The last oven set temperature appears in the display. Continue pressing until the desired oven temperature is displayed.



When the oven starts to heat, the words “BAKE ON” and the roasting temperature you set will be in the display.

After a few seconds, the words “LO PROBE” will replace the roasting temperature in the display.

After the internal temperature of the meat reaches 100°F., the changing internal temperature will be shown in the display.



7. When the internal temperature of meat reaches the number you have set, the probe and the oven turn off and the oven control signals. To stop the signal, press the CLEAR/OFF pad. Use hot pads to remove the probe from the food. Do not use tongs to pull on it—they might damage it.

CAUTION: To prevent possible burns, do not unplug the probe from the outlet until the oven has cooled. Do not store the probe in the oven.

NOTE:

- If the probe is removed from the food before the final temperature is reached, a tone will sound and the display will flash until the probe is removed from the oven.
- You can use the timer even though you cannot use timed oven operations.

To change the oven temperature during the Roast cycle, press the BAKE pad and then the + or – pad to get the new temperature.

REGULAR ROASTING



Questions and Answers

Q. Is it necessary to check for doneness with a meat thermometer?

A. Checking the finished internal temperature at the completion of cooking time is recommended if you did not use the probe while cooking. Temperatures are shown in the Roasting Guide. For roasts over 8 lbs., check with thermometer at half-hour intervals after half the cooking time has passed.

Q. Why is my roast crumbling when I try to carve it?

A. Roasts are easier to slice if allowed to cool 10 to 20 minutes after removing them from the oven. Be sure to cut across the grain of the meat.

Q. Do I need to preheat my oven each time I cook a roast or poultry?

A. It is not necessary to preheat your oven.

Q. When buying a roast, are there any special tips that would help me cook it more evenly?

A. Yes. Buy a roast as even in thickness as possible, or buy rolled roasts.

Q. Can I seal the sides of my foil “tent” when roasting a turkey?

A. Sealing the foil will steam the meat. Leaving it unsealed allows the air to circulate and brown the meat.

ROASTING GUIDE

Frozen Roasts

Frozen roasts of beef, pork, lamb, etc., can be started without thawing, but allow 10 to 25 minutes per pound additional time (10 minutes per pound for roasts under 5 pounds, more time for larger roasts).

Make sure poultry is thawed before roasting. Unthawed poultry often does not cook evenly. Some commercial frozen poultry can be cooked successfully without thawing. Follow the directions given on the package label.

Type	Oven Temperature	Doneness	Approximate Roasting Time in Minutes per Pound		Internal Temperature °F.
Meat			3 to 5 lbs.	6 to 8 lbs.	
Tender cuts; rib, high quality sirloin tip, rump or top round*	325°	Rare: Medium: Well Done:	24–33 35–39 40–45	18–22 22–29 30–35	140°–150°† 150°–160° 170°–185°
Lamb leg or bone-in shoulder*	325°	Rare: Medium: Well Done:	21–25 25–30 30–35	20–23 24–28 28–33	140°–150°† 150°–160° 170°–185°
Veal shoulder, leg or loin*	325°	Well Done:	35–45	30–40	170°–180°
Pork loin, rib or shoulder*	325°	Well Done:	35–45	30–40	170°–180°
Ham, precooked	325°	To Warm:	17–20 minutes per pound (any weight)		115°–120°
Poultry			3 to 5 lbs.	Over 5 lbs.	
Chicken or Duck	325°	Well Done:	35–40	30–35	185°–190°
Chicken pieces	350°	Well Done:	35–40		185°–190°
Turkey	325°	Well Done:	10 to 15 lbs. 18–25	Over 15 lbs. 15–20	In thigh: 185°–190°

*For boneless rolled roasts over 6 inches thick, add 5 to 10 minutes per pound to times given above.

†The U. S. Department of Agriculture says “Rare beef is popular, but you should know that cooking it to only 140°F. means some food poisoning organisms may survive.” (Source: *Safe Food Book. Your Kitchen Guide.* USDA Rev. June 1985.)



BROILING

Do not lock the oven door with the latch during broiling. The latch is used for self-cleaning only.

Broiling is cooking food by intense radiant heat from the upper broil element in the oven. Most fish and tender cuts of meat can be broiled. Follow these directions to keep spattering and smoking to a minimum.

Turn the food only once during broiling. Time the foods for the first side according to the Broiling Guide.

Turn the food, then use the times given for the second side as a guide to the preferred doneness.

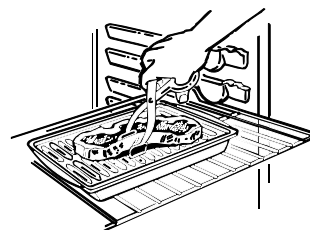

1. If the meat has fat or gristle around the edge, cut vertical slashes through both about 2 inches apart. If desired, the fat may be trimmed, leaving a layer about 1/8 inch thick.
2. Place the meat on the broiler grid in the broiler pan. Always use the grid so the fat drips into the broiler pan; otherwise the juices may become hot enough to catch on fire.
3. Position a flat shelf on the recommended shelf position as suggested in the Broiling Guide.

4. **Leave the door open to the broil stop position.** The door stays open by itself, yet the proper temperature is maintained in the oven.

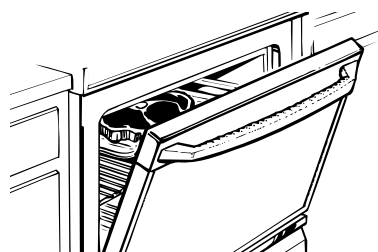

5. Press the BROIL pad.

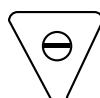

6. Press the + pad for HI broil or press the - pad for LO broil. To change from HI Broil to LO Broil, press the - pad once.



7. When broiling is finished press the CLEAR/OFF pad. Serve the food immediately, and leave the pan outside the oven to cool during the meal for easiest cleaning.

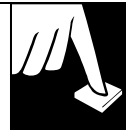

Use of Aluminum Foil

You can use aluminum foil to line your broiler pan and broiler grid. However, you must mold the foil tightly to the grid and cut slits in it just like the grid.

Without the slits, the foil will prevent fat and meat juices from draining to the broiler pan. The juices could become hot enough to catch on fire. If you do not cut the slits, you are frying, not broiling.

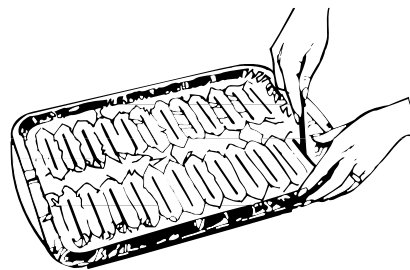

Questions and Answers

Q. When broiling, is it necessary to always use a grid in the pan?

A. Yes. Using the grid suspends the meat over the pan. As the meat cooks, the juices fall into the pan, thus keeping meat drier. Juices are protected by the grid and stay cooler, thus preventing excessive spatter and smoking.

Q. Do I need to grease my broiler grid to prevent meat from sticking?

A. No. The broiler grid is designed to reflect broiler heat, thus keeping the surface cool enough to prevent meat from sticking to the surface. However, spraying the broiler grid lightly with a vegetable cooking spray before cooking will make clean-up easier.

Q. Why are my meats not turning out as brown as they should?

A. In some areas, the power (voltage) to the range may be low. In these cases, preheat the broil element for 10 minutes before placing broiler pan with food in oven. Check to see if you are using the recommended shelf position. Broil for longest period of time indicated in the Broiling Guide. Turn the food only once during broiling.

Q. Should I salt the meat before broiling?

A. No. Salt draws out the juices and allows them to evaporate. Always salt after cooking. Turn the meat with tongs; piercing the meat with a fork also allows juices to escape. When broiling poultry or fish, brush each side often with butter.

(continued next page)



BROILING GUIDE

- Always use a broiler pan and rack. They are designed to minimize smoking and spattering by trapping juices in the shielded lower part of the pan.
- **The oven door should be open to the broil stop position.**
- If desired, marinate meats or chicken before broiling, or brush with barbecue sauce last 5 to 10 minutes only.
- When arranging food on the pan, do not let fatty edges hang over the sides because the dripping fat will soil the oven.
- Frozen steaks can be broiled by positioning the oven shelf at next lowest shelf position and increasing cooking time given in this guide 1½ times per side.
- Use LO Broil to cook foods such as poultry or thick pork chops thoroughly without over-browning them.

Food	Quantity and/or Thickness	Shelf Position	First Side Time, Minutes	Second Side Time, Minutes	Comments
Bacon	1/2 lb. (about 8 thin slices)	C	4½	4½	Arrange in single layer.
Ground Beef Well Done	1 lb. (4 patties) 1/2 to 3/4 inch thick	C	10	7	Space evenly. Up to 8 patties take about same time.
Beef Steaks					
Rare	1 inch thick	C	6	5	Steaks less than 1 inch thick cook through before browning. Pan frying is recommended.
Medium	(1 to 1½ lbs.)	C	8	6	
Well Done		C	12	11	
Rare	1½ inch thick	C	10	7-8	Slash fat.
Medium	(2 to 2½ lbs.)	C	15	14-16	
Well Done		C	25	20-25	
Chicken	1 whole (2 to 2½ lbs.), split lengthwise	A	35	10-15	Reduce time about 5 to 10 minutes per side for cut-up chicken. Brush each side with melted butter. Broil skin-side-down first.
Bakery Products					
Bread (Toast) or Toaster Pastries	2 to 4 slices	C or D	1½-2	1/2	Space evenly. Place English muffins cut-side-up and brush with butter, if desired.
English Muffins	1 pkg. (2) 2 (split)	C or D	3-4		
Lox	2-4 (6 to 8 oz. each)	B	13-16	Do not turn over.	Cut through back of shell. Spread open. Brush with melted butter before broiling and after half of broiling time.
Fish	1-lb. fillets 1/4 to 1/2 inch thick	C	5	5	Handle and turn very carefully. Brush with lemon butter before and during cooking, if desired. Preheat broiler to increase browning.
Ham Slices (precooked)	1 inch thick	B	8	8	Increase time 5 to 10 minutes per side for 1½ inch thick or home cured ham.
Pork Chops Well Done	2 (1/2 inch thick) 2 (1 inch thick), about 1 lb.	C B	10 13	10 13	Slash fat.
Lamb Chops					
Medium	2 (1 inch thick),	C	10	9	Slash fat.
Well Done	about 10 to 12 oz.	C	12	10	
Medium	2 (1½ inch thick),	C	14	12	
Well Done	about 1 lb.	B	17	12-14	
Wieners and similar precooked sausages, bratwurst	1-lb. pkg. (10)	C	6	1-2	If desired, split sausages in half lengthwise; cut into 5- to 6-inch pieces.

OPERATING THE SELF-CLEANING OVEN

Normal Cleaning Time: 3 hours



Quick Reminder:

1. Latch the door.
2. Press the AUTO SELF CLEAN pad.
3. Press the + or – pad to set the Clean Time.

Before a Clean Cycle

We recommend venting with an open window or using a ventilation fan or hood during the first self-clean cycle.

The range must be completely cool in order to set the self-clean cycle. You may have to allow the oven to cool before you can slide the door latch.

1. Remove all cookware and any aluminum foil from the oven—they cannot withstand the high cleaning temperatures.

NOTE: The oven shelves (including the offset shelf) and the roasting rack may be cleaned in the self-cleaning oven. However, they will darken, lose their luster and become hard to slide.

2. To avoid heavy smoke in the kitchen during self-cleaning, wipe up heavy soil on the oven bottom. (If you use soap, rinse thoroughly before self-cleaning to prevent staining.) The enamel grid and broiler pan may be cleaned in the self-clean oven. However, to help prevent heavy smoke caused by self-cleaning the greasy soil in the pan, you must first clean off the excess grease.

3. Clean spatters or spills on the oven front frame, and the oven door outside the gasket with a dampened cloth. The oven front frame and the oven door outside the gasket do not get cleaned by the self-clean cycle. On these areas use detergent and hot water or a soap-filled steel wool pad. Rinse well with a vinegar and water solution. This will help prevent a brown residue from forming when the oven is heated. Buff these areas with a dry cloth. Do not clean the gasket.

Clean the top, sides and outside front of the oven door with soap and water. Do not use abrasives or oven cleaners.

Make sure the oven light bulb cover is in place.

Do not rub or clean the door gasket—the fiberglass material of the gasket has an extremely low resistance to abrasion. An intact and well-fitting oven door gasket is essential for energy-efficient oven operation and good baking results. If you notice the gasket becoming worn, frayed or damaged in any way or if it has become displaced on the door, you should have it replaced.

4. Close the door and make sure the oven light is off. If the oven light is not turned off, the life of the bulb will be shortened or it may burn out immediately.

Do not use commercial oven cleaners or oven protectors in or near the self-cleaning oven.

A combination of any of these products plus the high clean cycle temperatures may damage the porcelain finish of the oven.

(continued next page)

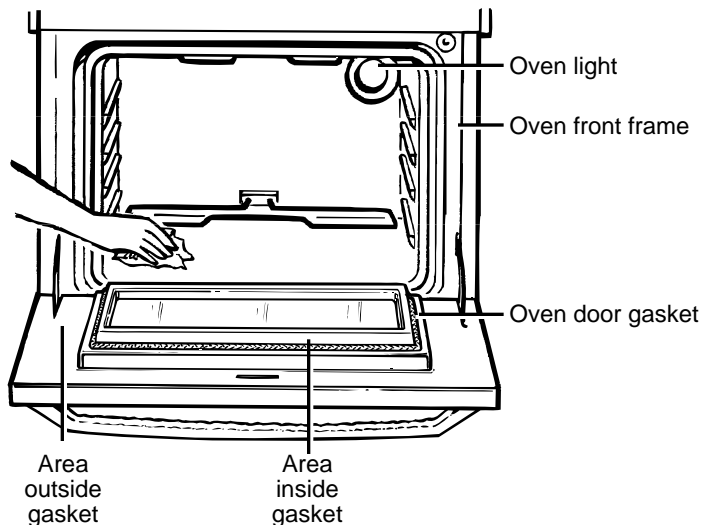



OPERATING THE SELF-CLEANING OVEN

(continued)

How to Set the Oven for Cleaning

Quick Reminder:

1. Latch the oven door.
2. Press the AUTO SELF CLEAN pad.
3. Press the + or – pad until the desired Clean Time appears.

If the oven is too hot and you start to set a clean cycle, the word “OFF” will appear in the display. Allow additional time for cooling before you try to set the cycle.

1. Follow the directions to prepare the oven for cleaning.

2. Close the oven door and slide the latch handle to the right as far as it will go.

Never force the door latch handle. Forcing the handle may damage the door lock mechanism.

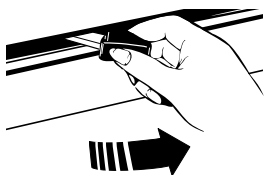

NOTE: The word “door” will be displayed, “LOCK” will flash and the oven control will signal if you set the Clean Cycle and forget to close or latch the oven door.



3. Press the AUTO SELF CLEAN pad.



4. Press the + or – pad until the desired Clean Time is displayed.

Clean Time is normally 3 hours. You can change the Clean Time to any time between 2 and 4 hours, depending on the amount of soil in your oven.

The self-clean cycle will automatically begin after “Clean” is displayed and the time for the Clean Cycle is set. The words “ON” and “LOCK” will appear in the display. It will not be possible to unlatch the oven door until the temperature drops below the lock temperature and the lock light goes off.

5. When the LOCK light is off, slide the latch handle to the left. If you cannot slide the latch easily to unlock the door, allow additional time for cooling.

NOTE: You can find out when the clean cycle will be finished by pressing the STOP TIME pad.

After a Clean Cycle

When the clean cycle is finished, the word “CLEAN” will go out in the display and the oven will begin to cool. When the oven temperature has fallen below the locking temperature, the word “LOCK” goes out and the door can be opened.

Slide the latch handle to the left as far as it will go and open the door.

Never force the latch handle. The latch slides easily. Forcing the latch handle may damage the door lock.



You may notice some white ash in the oven.

Just wipe it up with a damp cloth after the oven cools.

If white spots remain, remove them with a soap-filled steel wool pad. Be sure to rinse thoroughly with a vinegar and water mixture. These deposits are usually a salt residue that cannot be removed by the clean cycle.

If the oven is not clean after one clean cycle, repeat the cycle.

If the shelves have become hard to slide, wipe the shelf supports with cooking oil.

To Stop a Clean Cycle

1. Press the CLEAR/OFF pad.
2. When the LOCK light goes off and the oven has cooled below the locking temperature, open the door.

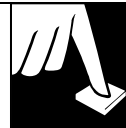

How to Delay Start of Cleaning

Quick Reminder:

1. Latch the oven door.
2. Press the AUTO SELF CLEAN pad.
3. Press the + or – pad until desired Clean Time appears.
4. Press the STOP TIME pad.
5. Press the + or – pad until the desired Stop Time appears in the display.

Delay Start is setting the oven timer to start the clean cycle automatically at a later time than the present time of day.

NOTE: Before beginning, make sure the oven clock shows the correct time of day.

1. Follow steps to prepare the oven for cleaning.
2. Slide the latch handle to the right as far as it will go.
3. Press the AUTO SELF CLEAN pad.
4. Press the + or – pad to enter the Clean Time.

5. Press the STOP TIME pad. The earliest Stop Time will be the Clean Time selected plus the time of day. **For example:** If the Clean Time is 3 hours and the time of day is 6:00, the Stop Time that appears in the display will be 9:00.

6. Press the + pad to change the Stop Time to a later time of day if desired. **For example:** If you set Stop Time at 11:00, oven will start clean cycle at 8:00 and end at 11:00.

The self-clean cycle will automatically begin after “CLEAN” is displayed and the time for the Clean Cycle is set. The words “ON” and “LOCK” will appear in the display. It will not be possible to open the oven door until the temperature drops below the lock temperature and the LOCK light goes off.

7. When the LOCK light is off, slide the latch handle to the left and open the door.

NOTE: During a delayed self-clean operation you can find out when the oven is set to turn on by pressing and holding the AUTO SELF CLEAN pad for 3 seconds.

Questions and Answers

Q. If my oven clock is not set to the correct time of day, can I still self-clean my oven?

A. If the clock is not set to the correct time of day you will not be able to set a delay clean to end at a specific time.

Q. Can I use commercial oven cleaners on any part of my self-cleaning oven?

A. No cleaners or coatings should be used around any part of this oven. If you do use them and do not thoroughly rinse the oven with water, wiping it absolutely clean afterwards, the residue can scar the oven surface and damage metal parts the next time the oven is automatically cleaned.

Q. Can I cook food on the cooktop while the oven is self-cleaning?

A. Yes. While the oven is self-cleaning, you can use the cooktop just as you normally do.

Q. What causes the hair-like lines on the enameled surface of my oven?

A. This is a normal condition, resulting from heating and cooling during cleaning. These lines do not affect how your oven performs.

Q. Should there be any odor during the cleaning?

A. Yes, there will be an odor during the first few cleanings. Failure to wipe out excessive soil might also cause a strong odor when cleaning.

Q. My oven shelves do not slide easily. What is the matter?

A. The self-clean cycle causes the oven shelves to lose their luster and become hard to slide. To make the shelves slide more easily, wipe the shelf supports with cooking oil.

Q. What should I do if excessive smoking occurs during cleaning?

A. This is caused by excessive soil. Press the CLEAR/OFF pad. Open the windows to rid the room of smoke. Wait until the oven has cooled and the word “LOCK” is off in the display. Wipe up the excess soil and reset the clean cycle.

Q. Is the “crackling” or “popping” sound I hear during cleaning normal?

A. Yes. This is the sound of the metal heating and cooling during both cooking and cleaning functions.

Q. Why do I have ash left in my oven after cleaning?

A. Some types of soil will leave a deposit which is ash. It can be removed with a damp sponge or cloth.

Q. My oven shelves have become gray after the self-clean cycle. Is this normal?

A. Yes. After the self-clean cycle, the shelves will lose some luster and change to a deep gray color.

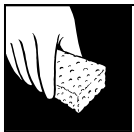

CARE AND CLEANING

Proper care and cleaning are important so your range will give you efficient and satisfactory service. Follow these directions carefully in caring for it to help assure safe and proper maintenance.

BE SURE ELECTRIC POWER IS OFF BEFORE CLEANING ANY PART OF THE RANGE.

⚠ If your range is removed for cleaning, servicing or any reason, be sure anti-tip device is re-engaged properly when the range is replaced. Failure to take this precaution could result in tipping of the range and cause injury.

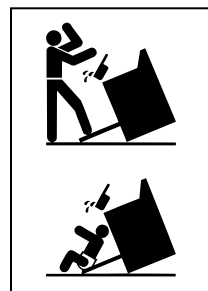

Control Panel and Knobs

Clean up any spills or spatters with a damp cloth. Remove heavier soil with warm, soapy water.

Clean the control panel with mild liquid dish detergent and a soft cloth. Rub the control panel lightly.

CAUTION: Do not use abrasives of any kind on the control panel. The lettering on models with touch pads is sensitive to abrasives and pressure.

The control knobs may be removed for easier cleaning. To remove a knob, pull it straight off the stem. Wash the knobs in soap and water but do not soak.

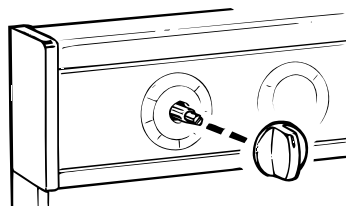

Cooktop Surface Light

When changing a cooktop light, do not touch the metal at the ends of the light.

The cooktop light is easily replaced with a fluorescent tube of the same wattage. Before changing the light, pull the plug to the range or disconnect the power at the main fuse or circuit breaker panel.

To remove:

- Lift the light cover by pulling the bottom edge toward you and then up.
- Place fingers on top near each end of the light.
- Roll the top of the light gently toward the front of the range and gently pull the light from the socket, making sure it does not hit the light cover.

To replace:

- Place fingers on the top near each end of the light.
- Press the light into the slots until it snaps into place.
- Move the light cover down and snap into place.

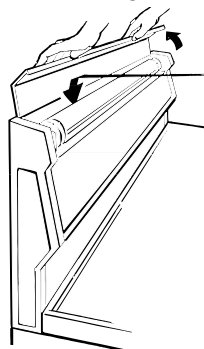

“Sure Grip” Handle

The soft door handle is easy to keep clean. Soil will easily wash off with soap and water or a non-abrasive all-purpose cleaner. Avoid using heavy-duty all-purpose cleaners and detergents, as they may contain chemicals which might harm the sure grip handle.

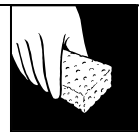

Lift-Off Oven Door

The oven door is removable, but it is heavy. You may need help removing and replacing the door. Do not lift the door by the handle. This can cause the glass to break or can cause damage to the door.

To remove the door, open it a few inches to the special stop position that will hold the door open. Grasp firmly on each side and lift the door straight up and off the hinges.

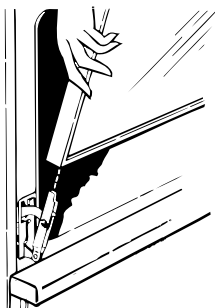

NOTE: Be careful not to place hands between the hinge and the oven door frame as the hinge could snap back and pinch fingers.

To replace the door, make sure the hinges are in the special stop position. Position the slots in the bottom of the door squarely over the hinges. Then lower the door slowly and evenly over both hinges at the same time. If hinges snap back against the oven frame, pull them back out. If the oven door is crooked, push down on the high corner to straighten it.

TO CLEAN THE DOOR:

Inside of the door:

- Because the area inside the gasket is cleaned during the self clean cycle, you do not need to clean this by hand. Any soap left on the liner causes additional stains when the oven is heated.
- The area outside the gasket can be cleaned with a scouring pad.

- Do not rub or clean the door gasket—the fiberglass material of the gasket has an extremely low resistance to abrasion. An intact and well-fitting oven door gasket is essential for energy-efficient oven operation and good baking results. If you notice the gasket becoming worn, frayed or damaged in any way or if it has become displaced on the door, you should have it replaced.

NOTE: The gasket is designed with a gap at the bottom to allow for proper air circulation.

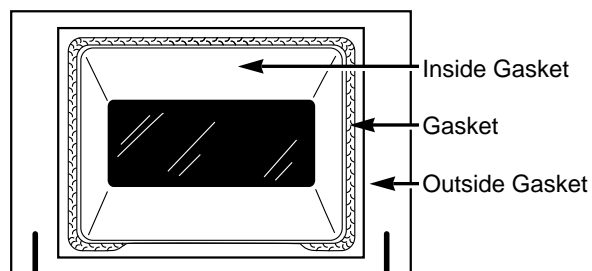

Outside of the door:

- Use soap and water to thoroughly clean the top, sides and front of the oven door. Rinse well. You may also use a glass cleaner to clean the glass on the outside of the door. To avoid water marks inside the glass front, do not let water drip into the vents.
- Spillage of marinades, fruit juices, tomato sauces and basting materials containing acids may cause discoloration and should be wiped up immediately. When surface is cool, clean and rinse.
- Do not use oven cleaners, cleansing powders or harsh abrasives on the outside of the door.

Oven Light Replacement

CAUTION: Before replacing your oven light bulb, disconnect the electric power for your range at the main fuse or circuit breaker panel or pull the plug. Be sure to let the light cover and bulb cool completely before removing or replacing them. When in use, light bulbs can become warm enough to break if touched with a moist cloth or towel. When cleaning, avoid touching warm lights with cleaning cloths if the light cover is removed.

The oven light (bulb) is covered with a removable glass cover which is held in place with a wire. Remove the oven door, if desired, to reach the cover easily.

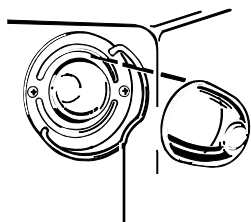

Wire Cover Holder

To remove: Hold your hand under the cover so it doesn't fall when released. With fingers of the same hand, firmly push back the wire cover holder. Lift off the cover.

DO NOT REMOVE ANY SCREWS.

- Replace bulb with 40-watt home appliance bulb.

To replace cover:

- Place it into the groove of the light receptacle. Pull the wire forward to the center of cover until it snaps in place. When in place, the wire holds the cover firmly. Be certain the wire is in the depression in the center of the cover.
- Connect electric power to the range.

(continued next page)



CARE AND CLEANING

(continued)

Probe

The temperature probe may be cleaned with soap and water or a soap-filled scouring pad. Cool the temperature probe before cleaning. Scour stubborn spots with a soap-filled scouring pad, rinse and dry.

Do not immerse the temperature probe in water.
Do not store the temperature probe in the oven.

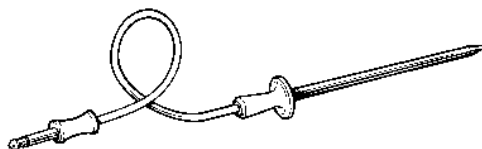

Broiler Pan and Grid

After broiling, remove the broiler pan from the oven. Remove the grid from the pan. Carefully pour out the grease from the pan into a proper container. Wash and rinse the broiler pan and grid in hot water with a soap-filled or plastic scouring pad.

The enamel grid and broiler pan may be cleaned in the self-clean oven. However, to prevent heavy smoke caused by self-cleaning the greasy soil in the pan, you must first clean off the excess grease.

If food has burned on, sprinkle the grid with detergent while hot and cover with wet paper towels or a dishcloth. Soaking the pan will remove burned-on foods.

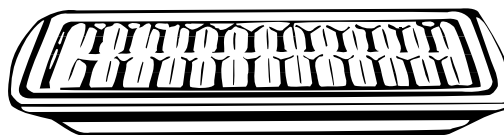

The broiler pan may be cleaned with a commercial oven cleaner. If the grid is grey enamel, it can also be cleaned with an oven cleaner. If the grid is chrome, do not use an oven cleaner to clean it.

Both the broiler pan and grid can also be cleaned in the dishwasher.

Do not store a soiled broiler pan and grid anywhere in the range.

Oven Shelves and Convection Roasting Rack

Clean the oven shelves (including the offset shelf) and the convection roasting rack with an abrasive cleanser or steel wool. After cleaning, rinse the shelves and rack with clean water and dry with a clean cloth.

NOTE: The oven shelves and convection roasting rack may be cleaned in the self-cleaning oven, however, the shelves will darken in color, lose their luster and become hard to slide if cleaned during the self-cleaning cycle. You can wipe the shelf supports with cooking oil after self-cleaning to make the shelves slide more easily.

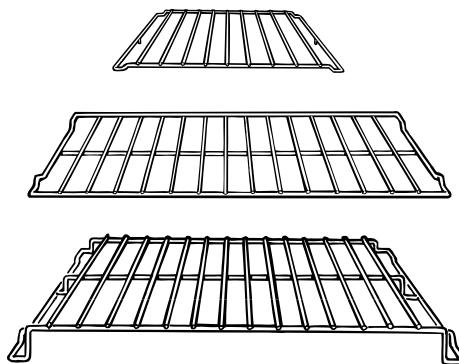

How to Remove the Storage Drawer or Kick Panel to Clean Under the Range

The area under the range can be reached easily for cleaning by removing the bottom drawer (on some models). To remove, pull the drawer out all the way, tilt up the front and remove it. To replace, insert glides at the back of the drawer beyond the stop on range glides. Lift the drawer if necessary to insert easily. Let the front of the drawer down, then push in to close.

To clean under models with a front kick panel, remove the panel by pulling it straight out at the bottom. To replace the panel, first hook the top tabs on and then the bottom tabs.



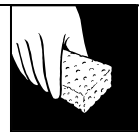

Painted Surfaces

Painted surfaces include the sides, control panel and drawer front. Clean these with soap and water or a vinegar and water solution.

Do not use commercial oven cleaners, cleansing powders, steel wool or harsh abrasives on any painted surface.

Metal Parts

Do not use steel wool, abrasives, ammonia or commercial oven cleaners. To safely clean surfaces; wash, rinse and then dry with a soft cloth.

Glass Window

To clean the outside of the oven window, use a glass cleaner. Rinse and polish with a dry cloth.

Oven Vent (Electric Coil Models)

The oven is vented through an opening under the right rear surface unit. Never cover the opening with aluminum foil or any other material. This would prevent the oven vent from working properly.

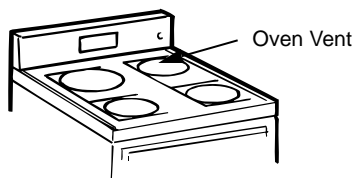

Oven Vent (Glass Cooktop Models)

The oven is vented through an opening at the rear of the cooktop. Never cover the opening with aluminum foil or any other material. This would prevent the oven vent from working properly.

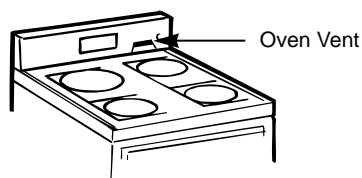

Convection cooking cooks most foods faster. This faster cooking causes the oven vent to put out more steam or water vapor than usual. The steam will condense on surfaces such as the cooktop, control panel and adjacent pans. This is normal.

Oven Heating Elements

Do not clean the bake element or the broil element. Any soil will burn off when the elements are heated.

The bake element can be lifted gently to clean the oven floor. If spillovers, residue or ash accumulate around the bake element gently wipe around the element with warm water.

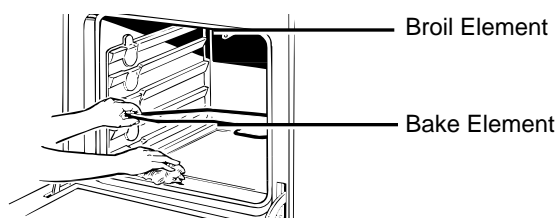

Porcelain Enamel Cooktop (Electric Coil Models)

The porcelain enamel finish is sturdy but breakable if misused. This finish is acid-resistant. However, any acidic foods spilled (such as fruit juices, tomato or vinegar) should not be permitted to remain on the finish.

If acids spill on the cooktop while it is hot, use a dry paper towel or cloth to wipe it up right away. When the surface has cooled, wash with soap and water. Rinse well.

For other spills such as fat splatterings, wash with soap and water or cleansing powders after the surface has cooled. Rinse well. Polish with a dry cloth.

(continued next page)



CARE AND CLEANING

(continued)

Lift-Up Cooktop (Electric Coil Models)

Some models have a cooktop that can be lifted up for easier cleaning. To make cleaning easier, the entire cooktop may be lifted up and supported in the up position.

Be sure all surface units are turned off before raising the cooktop. The surface units and drip pans do not need to be removed, however, you may remove one to make raising the cooktop easier. There are 2 side supports that lock into position when the cooktop is lifted up. The surface units do not need to be removed before lifting.

After cleaning under the cooktop with hot, mild soapy water and a clean cloth, lower the cooktop. Be careful not to pinch your fingers.

To lower the cooktop, push the rods back and gently lower the cooktop until it rests in place.

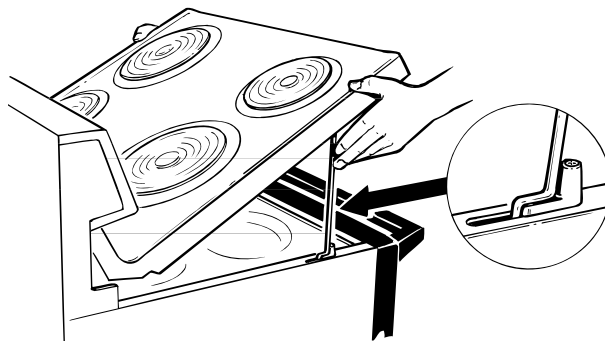

Surface Units/Drip Pans (Electric Coil Models)

To clean the surface units, turn the control to the highest setting for a minute. The coils will burn off any soil.

CAUTION

- **Be sure all the controls are turned to OFF and the surface units are cool before attempting to remove them.**
- Do not immerse the surface units in liquids of any kind.
- Do not clean the surface units in a dishwasher.
- Do not bend the surface unit plug terminals.
- Do not attempt to clean, adjust or in any way repair the plug-in receptacle.

To remove a surface unit:

To remove the drip pans for cleaning, the surface units must be removed first.

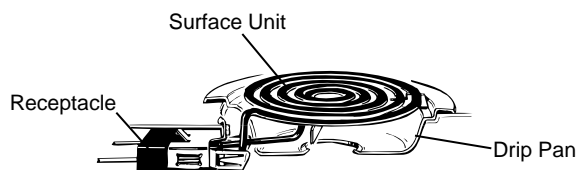

Lift the surface unit about 1 inch above the drip pan and pull it out.

Do not lift the surface unit more than 1 inch. If you do, it may not lie flat on the drip pan when you plug it back in.

Repeated lifting of the surface unit more than 1 inch above the drip pan can permanently damage the receptacle.

To replace a surface unit:

- Replace the drip pan into the recess in the cooktop. Make sure opening in the pan lines up with the receptacle.
- Insert the terminals of the surface unit through the opening in the drip pan and into the receptacle.
- Guide the surface unit into place so it rests evenly.

Drip Pans

Remove the surface units. Then lift out the drip pans.

For best results, clean the drip pans by hand. Place them in a covered container (or a plastic bag) with 1/4 cup ammonia to loosen the soil. Then scrub with a soap filled scouring pad if necessary. Rinse with clean water and polish with a clean soft cloth.

The drip pans may also be cleaned in the dishwasher.

Clean the area under the drip pans often.

Built-up soil, especially grease, may catch fire.

Do not cover the drip pans with foil. Using foil so close to the receptacle could cause shock, fire or damage to the range.

INSTALLATION INSTRUCTIONS

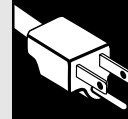

BEFORE YOU BEGIN

Read these instructions completely and carefully.

IMPORTANT: Save these instructions for the local electrical inspector's use.

IMPORTANT: OBSERVE ALL GOVERNING CODES AND ORDINANCES.

NOTE TO INSTALLER: Leave these instructions with the appliance after installation is completed.

NOTE TO CONSUMER: Keep this Use and Care Guide and Installation Instructions for future use.

NOTE: This appliance must be properly grounded.

TOOLS YOU WILL NEED

- Large blade screwdriver
- Channel lock pliers or small ratchet wrench with 3/16" socket (for leveling range)
- 1/4" hex head nutdriver

ELECTRICAL REQUIREMENTS

CAUTION, FOR PERSONAL SAFETY: DO NOT USE AN EXTENSION CORD WITH THIS APPLIANCE.

REMOVE HOUSE FUSE OR OPEN CIRCUIT BREAKER BEFORE BEGINNING INSTALLATION.

This appliance must be supplied with the proper voltage and frequency, and connected to an individual, properly grounded branch circuit, protected by a circuit breaker or time delay fuse, as noted on the rating plate.

Wiring must conform to National Electric Codes.

If the electric service provided does not meet the above specifications, it is recommended that a licensed electrician install an approved outlet.

Because range terminals are not accessible after range is in position, flexible service conduit or cord must be used.

STEP 1

PREPARE THE OPENING

1½" spacing is recommended from the range to adjacent vertical walls above cooktop surface.

Allow 30" minimum clearance between surface units and bottom of unprotected wood or metal top cabinet, and 15" minimum between countertop and adjacent cabinet bottom.

EXCEPTION: Installation of a listed microwave oven or cooking appliance over the cooktop shall conform to the installation instructions packed with that appliance.

To eliminate the risk of burns or fire by reaching over heated surface units, cabinet storage space above the surface units should be avoided. If cabinet storage is to be provided, the risk can be reduced by installing a range hood that projects horizontally a min. of 5" beyond the bottom of the cabinets. Make sure the wall coverings, countertops and cabinets around the range can withstand heat generated by the range, oven or cooktop up to 200° F.

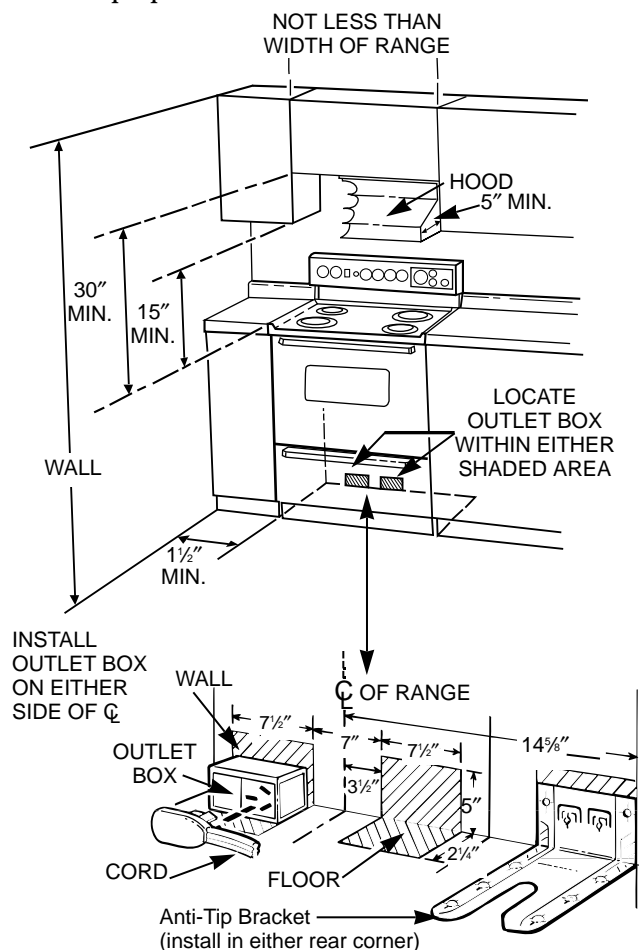

(continued next page)

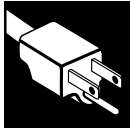

INSTALLATION INSTRUCTIONS

(continued)

PREPARE THE OPENING (continued)

Flooring Under the Range

Your range, like many other household items, is heavy and can settle into soft floor coverings such as cushioned vinyl or carpeting. When moving the range on this type of flooring, it should be installed on a 1/4 inch thick sheet of plywood (or similar material) as follows:

When the floor covering ends at the front of the range, the area that the range will rest on should be built up with plywood to the same level or higher than the floor covering. This will allow the range to be moved for cleaning or servicing.

STEP 2

PREPARE FOR ELECTRICAL CONNECTION

Effective January 1, 1996 the National Electric Code requires that new construction (not existing) utilize a 4 conductor connection to an electric range. When installing an electric range in new construction follow Steps 3 and 5 for 4 wire connection.

Use only 3-conductor or 4-conductor U.L. listed range cord. These cords may be provided with ring terminals on wire and strain relief device.

A range cord rated at **40 amps** with 125/250 minimum volt range is required. A 50 amp range cord is not recommended but if used, it should be marked for use with nominal 1 3/8" diameter connection openings. Care should be taken to center cable and strain relief within knockout hole to keep the edge from damaging the cable.

NOTE: A 4-conductor cord is to be used when the appliance is installed in a mobile home or when local codes do not permit grounding through the neutral. If conduit is being used, go to Step 6 or 7.

STEP 3

POWER CORD STRAIN RELIEF INSTALLATION

A. Remove the lower rear range wiring cover to expose the connector block and bracket.

B. Remove the knockout ring (1 3/8") located on bracket directly below the connector. To remove the knockout, use a pair of pliers to bend the knockout ring away from the bracket and twist until ring is removed.

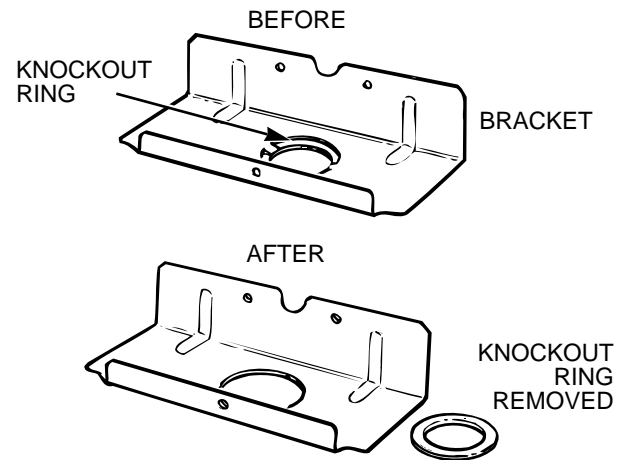

C. Assemble the strain relief in the hole. Insert the power cord through the strain relief and tighten. Allow enough slack to easily attach the cord terminals to the connector block. If tabs are present at the end of the winged strain relief, they can be removed for better fit.

NOTE: Do not install the power cord without a strain relief.

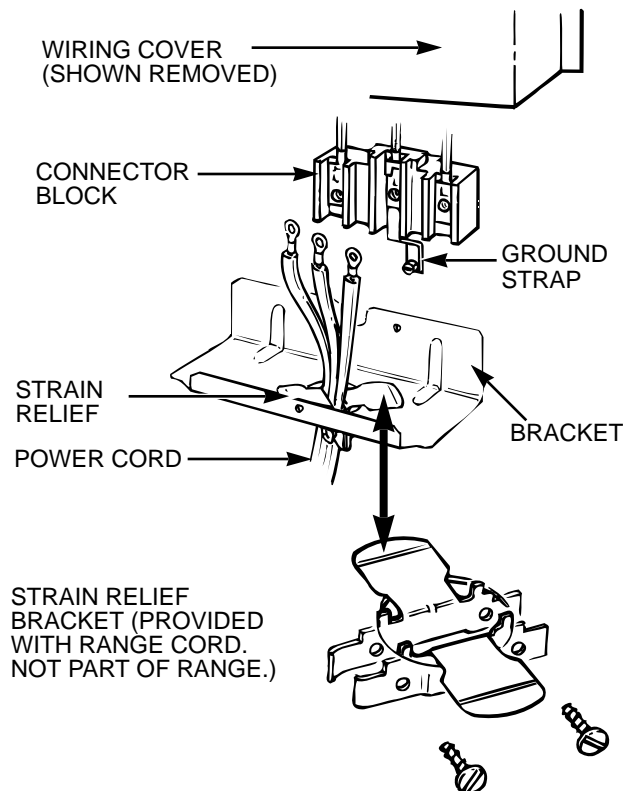

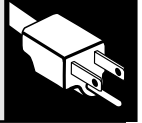

STEP 4

3 WIRE POWER CORD INSTALLATION

Remove the 3 wire terminal screws from the connector block. Insert screws through each power cord terminal ring and into the connector block until the screws engage the nuts. Be certain that the center wire is connected to the center screw of the connector block. Tighten screws securely. Do NOT remove ground strap connection.

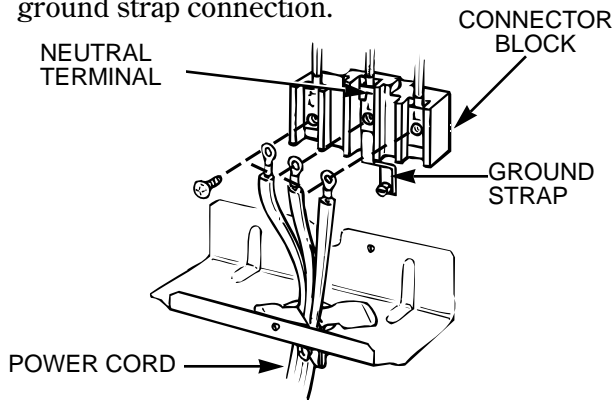

WARNING: THE NEUTRAL OR GROUND WIRE OF THE POWER CORD MUST BE CONNECTED TO THE NEUTRAL TERMINAL LOCATED IN THE CENTER OF THE CONNECTOR BLOCK. THE POWER LEADS MUST BE CONNECTED TO THE OUTSIDE (BRASS COLORED) TERMINALS.

STEP 5

4 WIRE POWER CORD INSTALLATION

A. Remove the 3 screws from the connector block.

B. Remove the grounding screw and strap from the connector block middle location and the screw connection to the frame of the range.

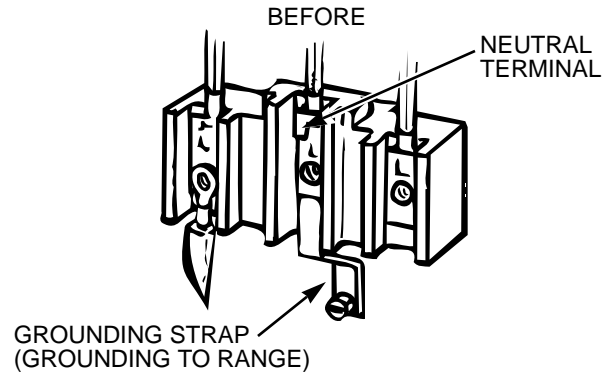

C. Insert screws through each power cord terminal ring and into connector block until screw engages nut. Be certain that the center wire is connected to the center screw of the connector block. Tighten screws securely.

D. Attach ground wire to the frame of the range.

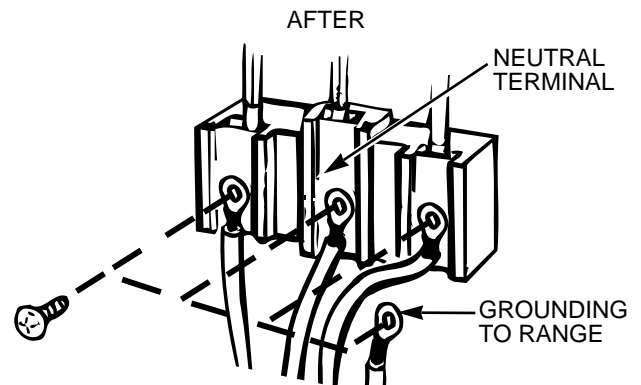

WARNING: THE NEUTRAL WIRE OF SUPPLY CIRCUIT IS CONNECTED TO THE NEUTRAL TERMINAL LOCATED IN THE CENTER OF THE CONNECTOR BLOCK. THE POWER LEADS MUST BE CONNECTED TO THE OUTSIDE (BRASS COLORED) TERMINALS. THE 4TH GROUNDING LEAD MUST BE CONNECTED TO THE FRAME OF THE RANGE WITH THE GROUNDING SCREW.

(continued next page)

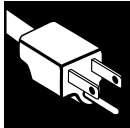

INSTALLATION INSTRUCTIONS

(continued)

STEP 6

3 WIRE CONDUIT INSTALLATION

Remove the 3 screws from the connector block. Insert bare wires between the connector block terminals and movable nuts. Tighten screws securely. Do not remove ground strap connection.

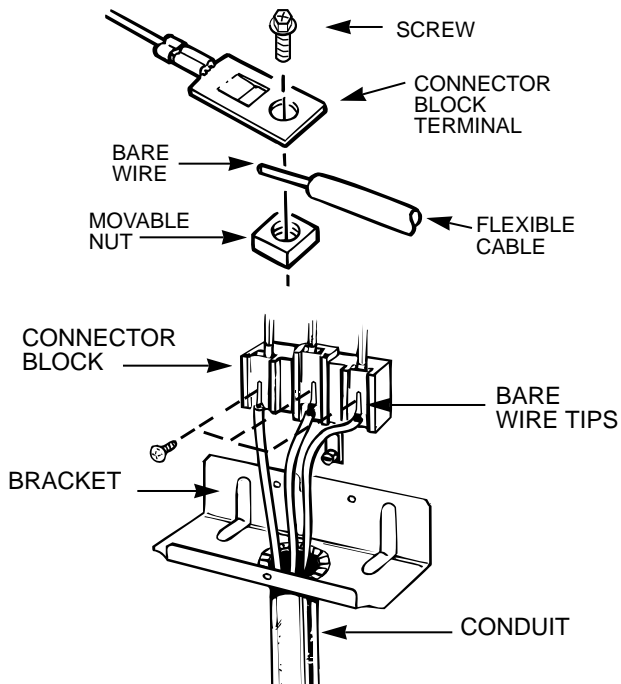

WARNING: CONNECTOR BLOCK IS APPROVED FOR COPPER WIRE CONNECTION ONLY. IF ALUMINUM WIRE IS USED, SEE NOTE BELOW.

NOTE: ALUMINUM WIRING

A. Do not connect Aluminum wire to connector block. Use copper building wire rated for the correct amperage and voltage to make 3 (three) 3 inch copper jumper wires. Connect wire as per Step 6 or 7 depending on number of wires.

B. Splice copper wires to aluminum wiring using special connector terminals designed and UL approved for joining copper to aluminum and follow the connector manufacturer's recommended procedure closely.

Wire used, location and enclosure of splices, etc., must conform to good wiring practices and local codes.

STEP 7

4 WIRE CONDUIT INSTALLATION

Remove the 3 screws from the connector block. Remove the grounding strap from the connector block middle location and the screw connecting it to the frame of the range. Insert bare wires between the connector block terminals and movable nuts. Tighten screws securely. Attach ground wire to the frame of the range.

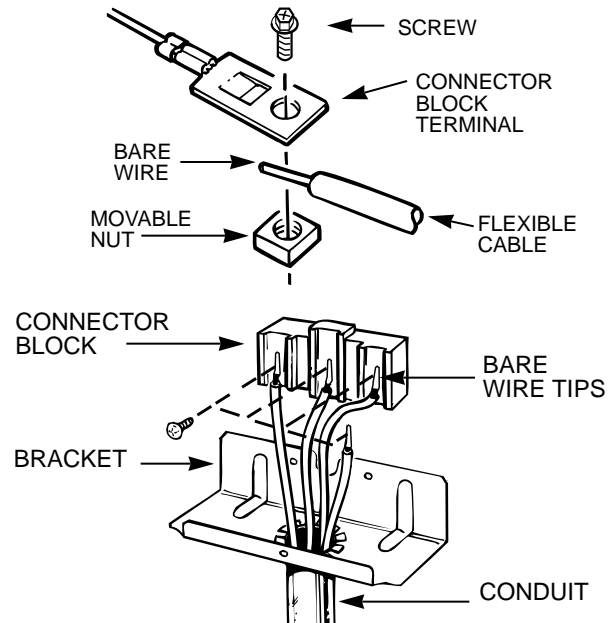

WARNING: CONNECTOR BLOCK IS APPROVED FOR COPPER WIRE CONNECTION ONLY. IF ALUMINUM WIRE IS USED, SEE NOTE BELOW.

NOTE: ALUMINUM WIRING

A. Do not connect Aluminum wire to connector block. Use copper building wire rated for the correct amperage and voltage to make 3 (three) 3 inch copper jumper wires. Connect wire as per Step 6 or 7 depending on number of wires.

B. Splice copper wires to aluminum wiring using special connector terminals designed and UL approved for joining copper to aluminum and follow the connector manufacturer's recommended procedure closely.

Wire used, location and enclosure of splices, etc., must conform to good wiring practices and local codes.

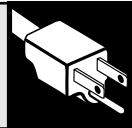

STEP 8

ANTI-TIP BRACKET INSTALLATION

AN ANTI-TIP bracket is supplied with instructions for installation in a variety of locations. The instructions include a template, a parts list and a list of tools necessary to complete the installation. Read the IMPORTANT SAFETY INSTRUCTIONS and the instructions that fit your situation before beginning installation.

WARNING

1. Range must be secured by ANTI-TIP bracket supplied.
2. See instructions to install (supplied with bracket).
3. Unless properly installed, range could be tipped by stepping or sitting on door. Injury might result from spilled hot liquids or from range itself.

Typical Installation of Anti-Tip Bracket Attachment to Wall

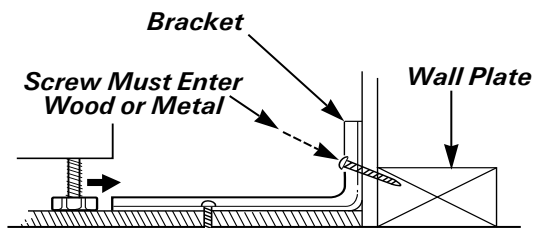

STEP 9

LEVELING THE RANGE

The range must be level. Leveling feet are located at each corner of the base of the range. Remove the storage drawer or kick panel (depending on your model) and using channel locks, rotate the leveling feet in and out as required to level the range. (For instructions on how to remove and replace the storage drawer or the kick panel, see the Cleaning Under the Range section in Care and Cleaning.) On some models, there are plastic covers which may be removed for easy adjustment (just squeeze and pull).

One of the rear leveling feet will engage the ANTI-TIP bracket (allow for some side to side adjustment). Allow a minimum clearance of 1/8-inch between the range and the leveling foot that is to be installed into the ANTI-TIP bracket.

Check the range for proper installation into the ANTI-TIP bracket (after the range has been properly installed) by removing the kick panel or storage drawer and inspecting the rear leveling leg. Make sure it fits securely into the slot.

STEP 10

FINAL CHECK

Be sure all switches are in the OFF position before leaving the range.



QUESTIONS? USE THIS PROBLEM SOLVER

PROBLEM	POSSIBLE CAUSE
“F-AND A NUMBER” FLASH IN THE DISPLAY	<ul style="list-style-type: none">• If the time display flashes “F-and a number”, you have function error code. If a function error code appears during the self-cleaning cycle, check the oven door latch. The latch may have been moved, even if only slightly, from the latched position. Make sure the latch is moved to the right as far as it will go. Press the CLEAR/OFF pad. Allow the oven to cool for one hour. Put the oven back into operation.• Disconnect all power to the range for 5 minutes and then reconnect power. If the failure code repeats, then call for service.
“OFF” APPEARS IN THE DISPLAY	<ul style="list-style-type: none">• Oven is too hot for the self-clean cycle to be set.• Bake or Broil cycles attempted too soon after self-cleaning. Let the oven cool longer.
CLOCK AND TIMER DO NOT WORK	<ul style="list-style-type: none">• Make sure the electrical plug is plugged into a live, properly grounded power outlet.• Check for power outage.• See the Oven Control, Clock and Timer section of this guide.
OVEN WILL NOT WORK	<ul style="list-style-type: none">• The plug on the range is not completely inserted in the electrical outlet.• The circuit breaker in your house has been tripped, or a fuse has been blown.• The oven controls are not properly set.• The door left in the locked position after cleaning.
OVEN LIGHT DOES NOT WORK	<ul style="list-style-type: none">• The light bulb is loose or defective. Tighten or replace.• The switch operating the oven light is broken. Call for service.
SURFACE LIGHT DOES NOT WORK	<ul style="list-style-type: none">• The fluorescent light is loose or defective. Adjust or replace.• Press the switch for 2 seconds. If the light does not come on, repeat.• The switch operating the light is broken. Call for service.
FOOD DOES NOT BROIL PROPERLY	<ul style="list-style-type: none">• The oven is not set at BROIL.• The door was not left open to the broil stop position as recommended.• Improper shelf position being used. See the Broiling Guide.• Food is being cooked on hot pan.• Cookware is not suited for broiling.• Aluminum foil used on the broil pan rack has not been fitted properly and slit as recommended.
FOOD DOES NOT ROAST OR BAKE PROPERLY	<ul style="list-style-type: none">• The oven is not set at BAKE.• Shelf position is incorrect. See the Roasting or Baking sections.• The oven shelf is not level.• Incorrect cookware or cookware of improper size is being used.• The oven thermostat needs adjustment. See the Adjust the Oven Thermostat–<i>Do It Yourself</i> section.
OVEN TEMPERATURE TOO HOT OR TOO COLD	<ul style="list-style-type: none">• The oven thermostat needs adjustment. See the Adjust the Oven Thermostat–<i>Do It Yourself</i> section.
OVEN WILL NOT SELF-CLEAN	<ul style="list-style-type: none">• The oven temperature is too high to set self-clean operation. Allow the range to cool to room temperature and reset the controls.• The door latch handle not moved all the way to the right.• Probe is plugged in the oven. Remove the probe.



PROBLEM	POSSIBLE CAUSE
OVEN DOOR ACCIDENTALLY LOCKED DURING COOKING	<ul style="list-style-type: none"> • Press the CLEAR/OFF pad. Allow the range to cool to room temperature and reset the controls.
OVEN DOOR WILL NOT UNLOCK	<ul style="list-style-type: none"> • The oven must cool below the locking temperature.
OVEN DOOR IS CROOKED	<ul style="list-style-type: none"> • Because the oven door is removable, it sometimes gets out of position during installation. To straighten the door, push down on the high corner.
OVEN NOT CLEAN AFTER CLEAN CYCLE	<ul style="list-style-type: none"> • The oven controls are not set properly. • Heavily soiled ovens may need to self-clean again or for a longer period. • Heavy spillovers should be cleaned before starting clean cycle.
“door” APPEARS IN THE DISPLAY	<ul style="list-style-type: none"> • The self-clean cycle has been selected but the latch handle was not moved all the way to the right. Move the latch handle. • The latch handle was moved to the right but another program other than self-clean was selected. Move latch handle to the right only when setting self-clean cycle.
CONTROL SIGNALS AFTER ENTERING OVEN TIME OR STOP TIME	<ul style="list-style-type: none"> • This is reminding you to enter a bake temperature.
Electric Coil Models	
SURFACE UNITS NOT FUNCTIONING PROPERLY	<ul style="list-style-type: none"> • Surface units are not plugged in solidly. • Drip pans are not set securely in the cooktop. • Surface unit controls are not properly set.
COOKTOP FEELS HOT	<ul style="list-style-type: none"> • Large pans hold heat close to the cooktop. • Pans on the right rear surface unit block air flow from the oven vent and cause the cooktop to get hot.
Glass Cooktop Models	
SURFACE UNITS WILL NOT MAINTAIN A ROLLING BOIL OR FRYING RATE IS NOT FAST ENOUGH	<ul style="list-style-type: none"> • You must use pans which are absolutely flat. If light can be seen between the pan bottom and a straight edge, the surface units will not transfer heat properly. • Pan bottoms should closely match the diameter of the surface unit selected.
SURFACE UNITS DO NOT WORK PROPERLY	<ul style="list-style-type: none"> • Difficulty may be in the main distribution panel of your house, caused by a blown oven-circuit fuse, a tripped oven-circuit breaker, the main fuse or the main circuit breaker, depending on the nature of the power supply. If a circuit breaker is involved, reset it. If the control box uses fuses, the oven fuse (a cartridge-type) should be changed, BUT ONLY BY SOMEONE FAMILIAR WITH ELECTRICAL CIRCUITS. If after performing one of these procedures, the fuse blows or circuit breaker trips again, call for service. NOTE: Apartment tenants or condominium owners should ask their building management to perform this check before calling for service. • If the range is connected to 208 volts, you will notice some increase in cooking times. • The cooktop surface unit controls are not properly set, or the wrong control knob is set for the surface unit you are using.

(continued next page)



THE PROBLEM SOLVER

(continued)

PROBLEM	POSSIBLE CAUSE
Glass Cooktop Models (continued)	
FOODS COOK SLOWLY	<ul style="list-style-type: none">• Improper cookware being used. Pan bottoms should be flat, fairly heavy weight and the same diameter as the surface unit selected.
TINY SCRATCHES (may appear as cracks) OR ABRASIONS ON GLASS COOKTOP SURFACE	<ul style="list-style-type: none">• Incorrect cleaning methods have been used, cookware with rough bottoms has been used, or coarse particles (salt or sand) were between the cookware and the surface of the cooktop. Use recommended cleaning procedures, be sure cookware bottoms and cookware are clean before use, and use cookware with smooth bottoms. Tiny scratches are not removable but will become less visible in time as a result of cleaning.
METAL MARKINGS (may appear as scratches)	<ul style="list-style-type: none">• Do not slide aluminum cookware across the surface. Use the recommended cleaning procedure to remove marks.• Incorrect cleaning materials have been used or encrusted boilovers or grease spatters remain on the surface. Use a razor scraper and the recommended cleaning procedure.
DARK STREAKS OR SPECKS	<ul style="list-style-type: none">• Use a razor scraper and recommended cleaning procedure.
AREAS OF DISCOLORATION ON COOKTOP	<ul style="list-style-type: none">• Marks from aluminum and copper pans as well as mineral deposits from water or food can be removed with the cleaning cream.
HOT SUGAR MIXTURES/ PLASTIC MELTED TO THE SURFACE	<ul style="list-style-type: none">• See the Glass Ceramic Cooktop Cleaning section.
FREQUENT CYCLING OFF AND ON OF SURFACE UNITS	<ul style="list-style-type: none">• Incorrect cookware used. Use only flat cookware to minimize cycling.

If you need more help...call, toll free:

GE Answer Center®

800.626.2000

consumer information service

NOTES

NOTES

We'll Be There

With the purchase of your new GE appliance, receive the assurance that if you ever need information or assistance from GE, we'll be there. All you have to do is call—toll-free!

GE Answer Center®

800.626.2000

Whatever your question about any GE major appliance, GE Answer Center® information service is available to help. Your call—and your question—will be answered promptly and courteously. And you can call any time. GE Answer Center® service is open 24 hours a day, 7 days a week.

In-Home Repair Service

800-GE-CARES (800-432-2737)

A GE consumer service professional will provide expert repair service, scheduled at a time that's convenient for you. Many GE Consumer Service company-operated locations offer you service today or tomorrow, or at your convenience (7:00 a.m. to 7:00 p.m. weekdays, 9:00 a.m. to 2:00 p.m. Saturdays). Our factory-trained technicians know your appliance inside and out—so most repairs can be handled in just one visit.

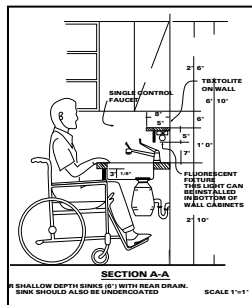

For Customers With Special Needs...

800.626.2000

Upon request, GE will provide Braille controls for a variety of GE appliances, and a brochure to assist in planning a barrier-free kitchen for persons with limited mobility. To obtain these items, free of charge, call 800.626.2000.

Consumers with impaired hearing or speech who have access to a TDD or a conventional teletypewriter may call 800-TDD-GEAC (800-833-4322) to request information or service.

Service Contracts

800-626-2224

You can have the secure feeling that GE Consumer Service will still be there after your warranty expires. Purchase a GE contract while your warranty is still in effect and you'll receive a substantial discount. With a multiple-year contract, you're assured of future service at today's prices.

Parts and Accessories

800-626-2002

Individuals qualified to service their own appliances can have parts or accessories sent directly to their home. The GE parts system provides access to over 47,000 parts...and all GE Genuine Renewal Parts are fully warranted. VISA, MasterCard and Discover cards are accepted.

User maintenance instructions contained in this guide cover procedures intended to be performed by any user. Other servicing generally should be referred to qualified service personnel. Caution must be exercised, since improper servicing may cause unsafe operation.

YOUR GENERAL ELECTRIC RANGE WARRANTY

Staple sales slip or cancelled check here. Proof of original purchase date is needed to obtain service under warranty.

WHAT IS COVERED

FULL ONE-YEAR WARRANTY

For one year from date of original purchase, we will provide, free of charge, parts and service labor in your home to repair or replace **any part of the range** that fails because of a manufacturing defect.

FULL FIVE-YEAR WARRANTY

(on some models) For five years from the date of original purchase, we will provide, free of charge, parts and service labor in your home to repair or replace the glass cooktop due to:

- Cracking of the glass cooktop due to thermal shock
- Discoloration of the glass cooktop
- Wear off of the pattern on the glass cooktop
- Cracking of the rubber seal between the glass cooktop and the porcelain edge

- Burn out of any of the radiant surface units.

This warranty is extended to the original purchaser and any succeeding owner for products purchased for ordinary home use in the 48 mainland states, Hawaii and Washington, D.C. In Alaska the warranty is the same except that it is LIMITED because you must pay to ship the product to the service shop or for the service technician's travel costs to your home.

All warranty service will be provided by our Factory Service Centers or by our authorized Customer Care® servicers during normal working hours.

Should your appliance need service, during warranty period or beyond, call 800-GE-CARES (800-432-2737).

WHAT IS NOT COVERED

- Service trips to your home to teach you how to use the product.

Read your Use and Care material.

If you then have any questions about operating the product, please contact your dealer or our Consumer Affairs office at the address below, or call, toll free:

GE Answer Center®
800.626.2000
consumer information service

- Improper installation.
If you have an installation problem, contact your dealer or installer. You are responsible for providing adequate electrical, gas, exhausting and other connecting facilities as described in the Installation Instructions provided with the product.
- Replacement of house fuses or resetting of circuit breakers.

- Damage to the glass cooktop caused by use of cleaners other than the recommended cleaning cream provided with the product.
- Damage to the glass cooktop caused by hardened spills of sugary materials or melted plastic that are not cleaned according to the directions in the Use and Care Guide.
- Damage to the product due to misuse or abuse.
- Failure of the product if it is used for other than its intended purpose or used commercially.
- Damage to product caused by accident, fire, floods or acts of God.

WARRANTOR IS NOT RESPONSIBLE FOR CONSEQUENTIAL DAMAGES.

Some states do not allow the exclusion or limitation of incidental or consequential damages, so the above limitation or exclusion may not apply to you. This warranty gives you specific legal rights, and you may also have other rights which vary from state to state. To know what your legal rights are in your state, consult your local or state consumer affairs office or your state's Attorney General.

Warrantor: General Electric Company

**If further help is needed concerning this warranty, write:
Manager—Consumer Affairs, GE Appliances, Louisville, KY 40225**

This book is printed on recycled paper.

Part No. 164D2966P235

Pub No. 49-8724

10-95 CG

JBP80
JBP90
JBP95

Printed in Louisville, KY