

Rotisserie/Convection Oven Combination

MODEL VGG-CO

Operation & Installation Manual



Fresh ideas in foodservice equipment

Warranty Information

LIMITED ONE YEAR WARRANTY

BKI (The "Company") warrants to the original purchaser that at time of shipment from the Company factory, this equipment will be free from defect in materials and workmanship. Written notice of a claim under this warranty must be received by the Company within ONE YEAR from the date of installation, but no longer than ONE YEAR AND THREE MONTHS from date of shipment from the factory. Defective conditions caused by abnormal use or misuse, lack of or improper maintenance, damage by third parties, alterations by unauthorized personnel, acts of God, failure to follow installation and/or operating instructions, or any other events beyond the reasonable control of the Company will NOT be covered under this warranty. The obligation of the Company under this warranty shall be limited to repairing or replacing (at the option of the Company) any part, with the exception of lamps, fuses, and glass (which are not covered under warranty), which is found defective in the reasonable opinion of the Company. Any part found defective by the Company will be repaired or replaced without charge F.O.B. factory, Simpsonville, South Carolina or F.O.B. authorized BKI Distributor. The Company and/or its authorized representatives will assume the normal replacement labor expense for the defective part for the period of the warranty as stated above, excluding travel and/or other expenses incidental to the replacement of the defective part, where replacement work is performed during standard business hours and not subject to overtime, holiday rates, and/or any additional fees. IN NO EVENT SHALL THE COMPANY BE LIABLE FOR LOSS OF USE, LOSS OF REVENUE OR LOSS OF PRODUCT OR PROFIT OR FOR INDIRECT OR CONSEQUENTIAL DAMAGES INCLUDING BUT NOT LIMITED TO, FOOD SPOILAGE OR PRODUCT LOSS. WARRANTY DOES NOT COVER GLASS BREAKAGE. THE ABOVE WARRANTY IS EXCLUSIVE AND ALL OTHER WARRANTIES, EXPRESS OR IMPLIED, ARE EXCLUDED INCLUDING THE IMPLIED WARRANTIES OF MERCHANTABILITY AND FITNESS FOR A PARTICULAR PURPOSE.

REPLACEMENT PARTS

Any appliance replacement part, with the exception of lamps, fuses, and glass, which proves to be defective in material or workmanship within ninety (90) days of installation will be replaced without charge F.O.B. Factory, Simpsonville, SC or F.O.B. authorized BKI Distributor. The user shall have the responsibility and expense of removing and returning the defective part to the Company as well as the cost of reinstalling the replacement or repaired part.

Table of Contents

| | |
|--|-----------|
| Table of Contents | 1 |
| Introduction | 2 |
| Safety Precautions | 2 |
| Safety Signs and Messages | 2 |
| Specific Precautions | 3 |
| Safe Work Practices | 3 |
| Safety Labels | 6 |
| Health And Sanitation Practices..... | 7 |
| Food Handling..... | 7 |
| Storage Of Raw Meats..... | 7 |
| Coding Cooked Foods..... | 7 |
| Storage Of Prepared Foods..... | 7 |
| Installation | 8 |
| Unpacking and Handling | 8 |
| Location and Clearance | 8 |
| Wiring | 8 |
| Operation | 9 |
| VGG-8 Operation | 9 |
| Controls and Indicators | 9 |
| Programming the Controller Using the Touchscreen Interface | 14 |
| Programming the Controller Using the RS-232 Interface | 15 |
| Operation with the Controller | 16 |
| Accessory Use | 17 |
| CO Operation | 18 |
| Controls and Indicators | 18 |
| Operating the Oven..... | 20 |
| Cooking Suggestions | 20 |
| Maintenance | 21 |
| Scheduled Maintenance..... | 21 |
| VGG Oven Cleaning (Daily)..... | 21 |
| CO Oven Cleaning..... | 24 |
| Troubleshooting..... | 25 |
| VGG | 25 |
| CO..... | 26 |
| Notes | 28 |

Introduction

Your **BKI** VGG-CO is a computer controlled VGG-8 rotisserie oven mounted atop a convection oven. The VGG-8 utilizes a revolving mechanism and convection heat to ensure even product cooking. A touchscreen control and switches are provided to allow for quick setup and operation. The convection oven is 7.14 cubic feet and has a solid state timing control. Both units have removable components that allow for easy maintenance and cleaning.

The **BKI** name and trademark on this unit assures you of the finest in design and engineering -- that it has been built with care and dedication -- using the best materials available. Attention to the instructions in this manual regarding proper installation, operation, and maintenance will result in long lasting dependability and ensure the highest profitable return on your investment.

NOTICE

PLEASE READ THIS ENTIRE MANUAL BEFORE OPERATING THE UNIT. If you have any questions, please contact your BKI Distributor. If they are unable to answer your questions, phone the applicable BKI Technical Services Department:

BKI North America: (864) 963-3471

BKI Europe: (44) 0870 9904242

Safety Precautions

Always follow recommended safety precautions listed in this manual. Below is the safety alert symbol. When you see this symbol on your equipment, be alert to the potential for personal injury or property damage.

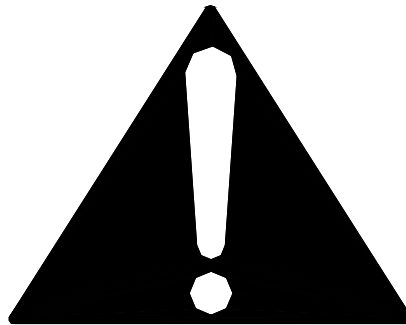

Safety Signs and Messages

The following Safety signs and messages are placed in this manual to provide instructions and identify specific areas where potential hazards exist and special precautions should be taken. Know and understand the meaning of these instructions, signs, and messages. Damage to the equipment, death or serious injury to you or other persons may result if these messages are not followed.

DANGER

This message indicates an imminently hazardous situation which, if not avoided, will result in death or serious injury.

WARNING

This message indicates a potentially hazardous situation, which, if not avoided, could result in death or serious injury.

CAUTION

This message indicates a potentially hazardous situation, which, if not avoided, may result in minor or moderate injury. It may also be used to alert against unsafe practices.

NOTICE

This message is used when special information, instructions or identification are required relating to procedures, equipment, tools, capacities and other special data.

Specific Precautions

CAUTION

Equipotential Ground Plane

When a high current flows through a conductor, differences in potential appear between the conductor and nearby metallic surfaces near the appliance. As a result, sparks may be produced between the appliance and surrounding metal surfaces. These sparks could cause serious injury, damage, or fire.

BKI provides an Equipotential ground terminal for the connection of a bonding conductor after the installation of the appliance per IEC60417-1. This terminal is located on the drive side of the oven base and is marked with this symbol.



NOTICE

Full Disconnection for IEC / CE Regulations

In accordance with Local and/or National wiring codes, the installer must provide a means of full disconnection for overvoltage Category III conditions. An IEC approved cord and plug combination will meet this requirement.

Units not provided with a cord and plug do not meet this requirement. In accordance with Local and/or National wiring codes, the installer must provide the means of full disconnection.

Safe Work Practices

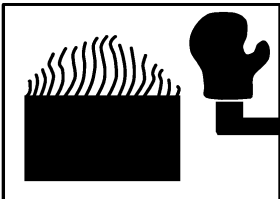

Wear Safe Clothing Appropriate To Your Job

Always wear your insulated mitts when handling hot oven parts or touch any hot metal surface. If you lose or damage your mitts, you can buy new ones at your local restaurant equipment supply store or from your local **BKI** Distributor.

Always wear non-skid shoes when working around the oven or any other equipment.

Never wear loose clothing such as neckties or scarves while operating this equipment. Keep loose hair tied back or in a hair net while operating this equipment.

Always wear appropriate personal protection equipment during the cleaning process to guard against possible injury.



WARNING – DANGEROUS VOLTAGE

This equipment uses high voltage. Serious injury can occur if you or any untrained or unauthorized person installs, services, or repairs this equipment. Always Use an Authorized Service agent to Service Your Equipment.

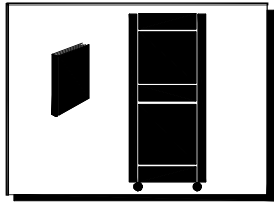

Keep this manual with the Equipment

This manual is an important part of your equipment. Always keep it near for easy access. If you need to replace this manual, phone the applicable BKI Technical Services Department:

BKI North America: (864) 963-3471

BKI Europe: (44) 0870 9904242



Protect Children

Keep children away from this equipment. Children may not understand that this equipment is dangerous for them and others.

NEVER allow children to play near or operate your equipment.

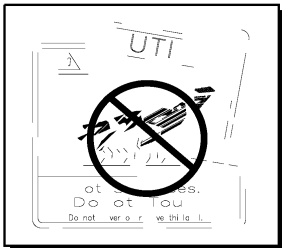

Keep Safety Labels Clean and in Good Condition

Do not remove or cover any safety labels on your equipment. Keep all safety labels clean and in good condition. Replace any damaged or missing safety labels. Refer to the Safety Labels section for illustration and location of safety labels on this unit. If you need a new safety label, obtain the number of the specific label illustrated on page 6, then phone the applicable BKI Technical Services Department:

BKI North America: (864) 963-3471

BKI Europe: (44) 0870 9904242

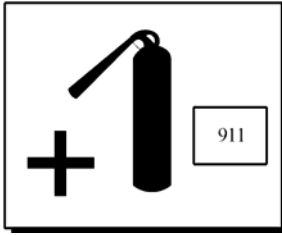
**Be Prepared for Emergencies**

Be prepared for fires, injuries, or other emergencies.

Keep a first aid kit and a fire extinguisher near the equipment. You must use a 40-pound Type BC fire extinguisher and keep it within 25 feet of your equipment.

Keep emergency numbers for doctors, ambulance services, hospitals, and the fire department near your telephone.

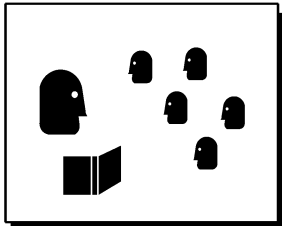
**Know your responsibilities as an Employer**

- Make certain your employees know how to operate the equipment.
- Make certain your employees are aware of the safety precautions on the equipment and in this manual.
- Make certain that you have thoroughly trained your employees about operating the equipment safely.
- Make certain the equipment is in proper working condition. If you make unauthorized modifications to the equipment, you will reduce the function and safety of the equipment.

Safety Labels

| Label Description | BKI Part # | QTY | Location |
|--|------------|------|---|
| Caution – Do not use harsh cleaners when cleaning this unit. | N0166 | 1 | Front Control panel (below switches) |
| Danger – High Voltage. Turn power off before servicing. May have more than one disconnect switch. | N0202 | 2(3) | Side covers & Power entry hole on control panel |
| Danger – This appliance has more than one power supply connection point. Disconnect all power supplies before servicing. | N0298 | 1 | Top of CO back control panel |
| Warning – For continued protection against risk of fire and electrical shock, replace with 15 Amp fuse only. | N0542 | 1 | On fuse bracket inside component compartment |
| CO Rating Tag | N0023 | 1 | Bottom of back control panel |
| Warning – Risk of electrical shock. Appliance must be secured to building structure. See installation instructions. | QC Printed | 1 | On panel between back control panel and motor plate at bottom |

Health And Sanitation Practices

BKI Rotisserie Ovens are manufactured to comply with health regulations and are tested and certified to NSF and FSA standards. You must operate the equipment properly, using only quality products and use meat thermometers to insure meats are thoroughly cooked.

Food Handling

- Wash hands thoroughly in warm, soapy water after handling raw poultry or meats.
- Clean and sanitize all utensils and surfaces that have been in contact with raw products. Clean and sanitize the meat forks or baskets between cooking.
- **Never** place cooked meats on the same surfaces used to prepare raw meats, unless the area has been thoroughly cleaned and sanitized.

Storage Of Raw Meats

- Designate an area or shelf strictly for the storage of all raw meats to be used in the rotisserie.
- Raw product must always be stored at temperatures below 38° F. (3° C.).
- **Never** store or mix raw foods above cooked foods, as this is a health hazard. The drippings from raw foods contaminate cooked or processed foods.
- All chicken and chicken parts to be stored overnight must be thoroughly iced down and refrigerated.

Coding Cooked Foods

All products cooked during the day should be sold the same day.

NOTE: It is not the intent of the rotisserie program to have unsold merchandise at the end of the cooking day. Follow your company's procedures for the handling of any leftover product.

Storage Of Prepared Foods

- Cold foods should be kept at or below 38° F. (3° C.).
- Hot foods must be maintained to meet local health codes, usually a minimum 145° F. (63° C.).

Installation

⚠ WARNING Serious injury, equipment damage or death could result if attempting to install this oven yourself. Ensure that an authorized BKI service agent install the oven.

⚠ WARNING “Risk of Electrical Shock – Appliance must be secured to building structure. Follow tethering kit instructions for installation” (sold separately).

Unpacking and Handling

It is the owners’ responsibility to file all freight claims with the delivering truck line. Inspect all cartons and crates for damage as soon as they arrive. If damage to cartons or crates is found, or if a shortage is found, note this on the bill of lading (all copies) prior to signing.

If damage is found when the equipment is opened, immediately call the delivering truck line and follow up the call with a written report indicating concealed damage to your shipment. Ask for an immediate inspection of your concealed damage item. Packaging material **MUST** be retained to show the inspector from the truck line.

Remove all packing from the interior and exterior of the oven.

Location and Clearance

1. Place the unit not less than 8” from the back wall.
2. Lock the casters so the oven does not move. After every time the oven is moved, make sure the casters are locked.

Wiring

⚠ WARNING Electrocutation, equipment failure or property damage could result if an unlicensed electrician performs the electrical installation. Ensure that a licensed electrician perform the electrical installation.

The oven, when installed by an authorized BKI service agent, must be grounded in accordance with local codes, or in the absence of local codes, with the National Electrical Code, ANSI NFPA 70-2002. You can obtain this code from:

The National Fire Protection Association
Batterymarch Park
Quincy, MA 02269

Operation

VGG-8 Operation

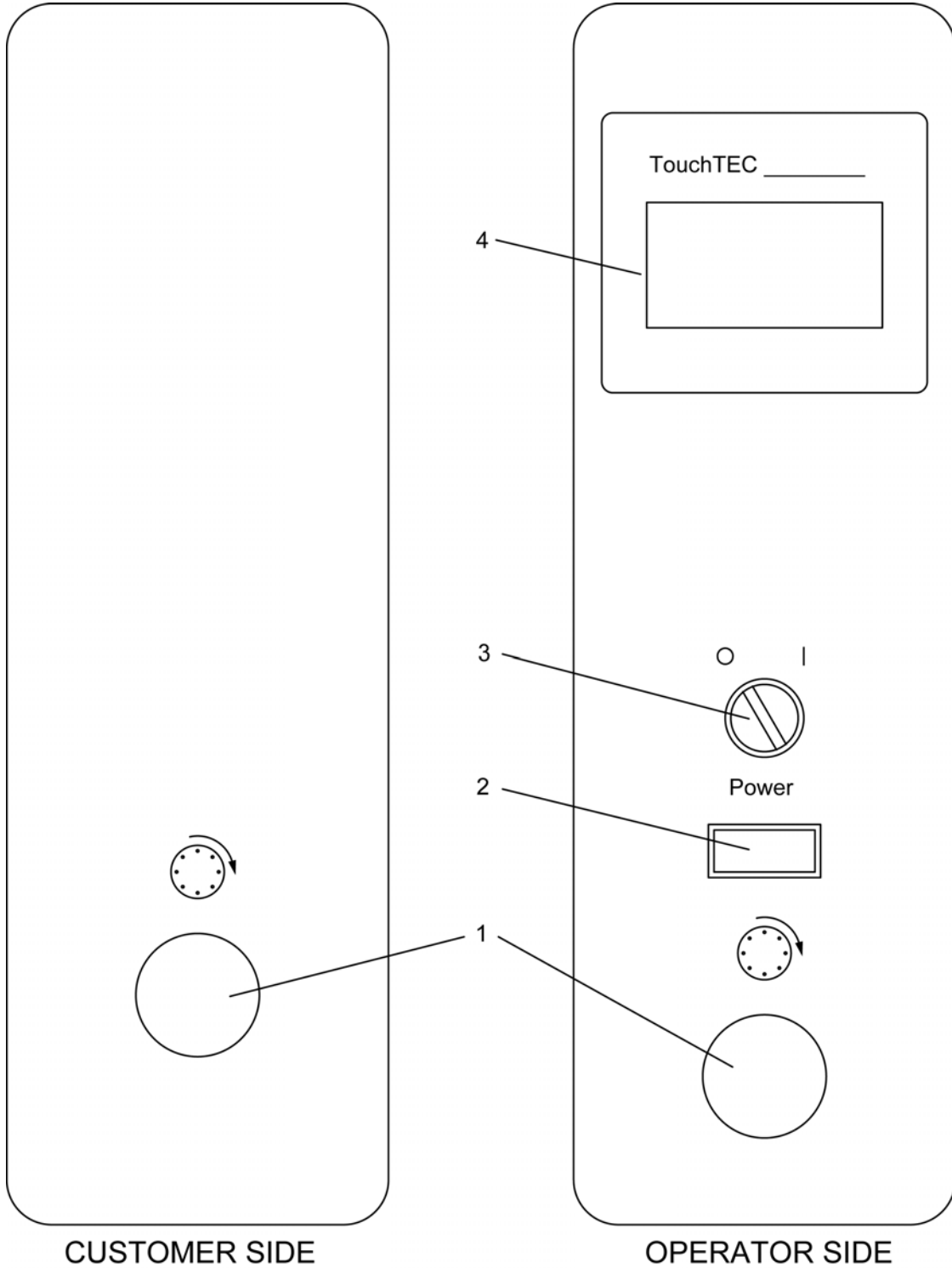

Controls and Indicators





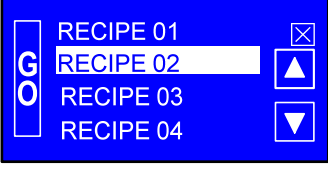
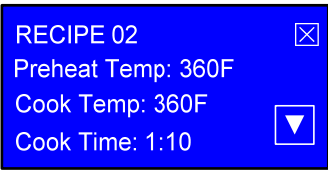
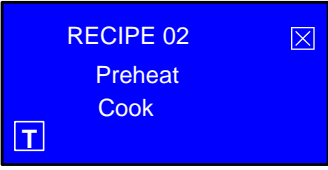

Hardware Controls

| Item # | Description | Function |
|--------|-------------------------------|--|
| 1 | Rotor Switch | Depressing the switch allows the operator to “jog” the rotor position when the door is open. Releasing the switch stops the rotor. |
| 2 | Main Power Isolator Light | This light illuminates to indicate that power is being applied to the oven from the Main Power Isolator (Circuit Breaker). |
| 3 | Main Power Switch | Turns power to the entire unit on or off. When placed in the on position, the Touchscreen controller is powered, lights illuminate and the rotor motor engages (if both doors are closed). When placed in the off position, power is removed from the entire unit. |
| 4 | Analog Touchscreen Controller | Used for operation and programming of the oven. A built-in beeper is used to indicate touchscreen presses and other oven functions. It has 15 programmable cooking recipes. |



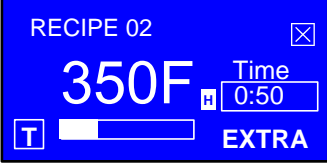

Software Controls – Operation Screens



| Screen Name | Screen | Description |
|------------------------|---|--|
| Startup |  | Appears when the Main Power Switch is placed in the on position. |
| Controller Off |  | Appears after the Startup screen displays. This screen indicates that the controller is turned off. Touching anywhere on the screen will turn the controller on and display the Recipe Selection screen. |
| Recipe Selection |  | Displays a list of available recipes. The up and down arrow buttons move the highlight box from one recipe to the next. Once the desired recipe is highlighted the user touches the GO button to start the cook cycle. Touching the X button for 3 seconds turns the controller off. Touching any recipe will show the settings for that recipe. |
| Recipe Settings |  | Displays Preheat Temperature, Cook Temperature, Cook Time, Hold Temperature and Cook To settings for a selected recipe. Touching the up and down arrow buttons scroll the screen to view more settings. Touching the X button momentarily returns you to the previous screen. |
| Preheat/Cook Selection |  | Displays once the user highlights a recipe and touches the GO button if the recipe has a preheat temperature programmed. The user selects where to start the cooking cycle by touching Preheat or Cook . Touching Preheat displays the Preheat screen. Touching Cook displays the Ready To Cook screen. If the Preheat temperature is set to OFF the controller goes directly to the Ready To Cook screen. The T button can be used to display the current oven temperature. Touching the T button displays the temperature, then automatically returns to the previous screen in 2 seconds. Touching the X button momentarily returns you to the previous screen. |

| Screen Name | Screen | Description |
|---------------|---|--|
| Preheat |  | <p>Displays once the user touches the Preheat option from the Preheat/Cook Selection screen. The Preheat cycle heats the cooking cavity up to the pre-defined preheat temperature. Once this temperature is reached the unit automatically switches to the Ready To Cook mode. A small highlighted letter H will appear to the right of the temperature display to indicate that the controller has energized the heating elements. The absence of the letter H indicates that the controller has de-energized the heating elements as the oven temperature has reached the set temperature limit. The T button works as described for the Preheat/Cook Selection screen. Touching the X button for 3 seconds returns you to the Recipe Selection screen.</p> |
| Ready to Cook |  | <p>Displays once the user touches the Cook option from the Preheat/Cook selection screen or once the preheat cycle is finished or directly from the Recipe Selection screen if no preheat temperature was programmed. When the temperature is within 5° of the cook temperature the controller will emit three 2 second beeps indicating that the product can be loaded. The user places the product to be cooked into the cooking cavity and touches the COOK button to start the cooking process. If the door is opened and/or the temperature drops below 25° below the preheat temperature, the screen will flash and beep every 30 seconds until the COOK button is touched. The highlighted letter H works as described for the Preheat screen. The T button works as described for the Preheat/Cook Selection screen. Touching the X button for 3 seconds returns you to the Recipe Selection screen.</p> |
| Cooking |  | <p>Displays once the COOK button is touched from the Ready To Cook screen. This screen shows the cooking temperature, the time remaining in the cook cycle, and the elapsed time shown with the progress bar at the bottom of the screen. Hold the X button for 2 seconds to stop the cook in progress. The EXTRA button can be used to add more cook time to the cycle. The cook cycle ends when the cook time elapses. This is indicated by three 2 second beeps. If a hold temperature was programmed then the Hold screen is displayed. If no hold temperature was programmed then the screen will flash and beep until touched. The highlighted letter H works as described for the Preheat screen. The T button works as described for the Preheat/Cook Selection screen. Touching the X button for 3 seconds returns you to the Preheat/Cook Selection screen.</p> |

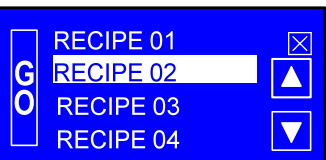
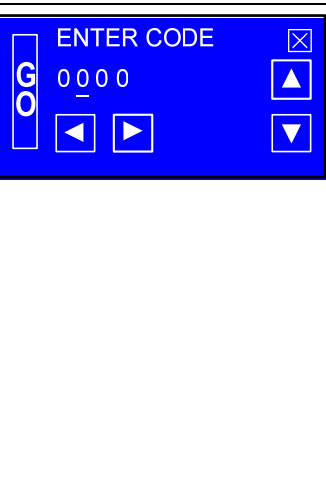
| Screen Name | Screen | Description |
|-------------|---|--|
| Hold |  | <p>Displays once the cook cycle is complete if a hold temperature was programmed. This screen displays the hold temperature (or nothing if set to OFF), and the elapsed time in the hold mode. The EXTRA button is available here so the product can be cooked for more time if required. The highlighted letter H works as described for the Preheat screen. The T button works as described for the Preheat/Cook Selection screen. Touching the X button for 3 seconds returns you to the Recipe Selection screen.</p> |
| Extra Cook |  | <p>Appears when the EXTRA button is touched from the Cooking or Hold screens. Use the up and down arrow buttons to set the amount of additional cook or hold time in 5 minute increments. Touch the GO button to add the additional time you set. Touch the X button to return to the previous screen without adding any extra cook or hold time.</p> |

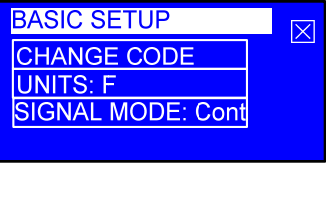
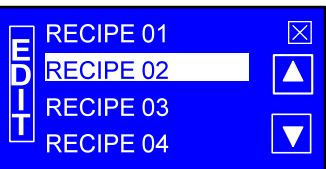
Software Controls – Programming Screens

| Screen Name | Screen | Description |
|------------------------|---|---|
| Startup |  | <p>Appears when the Main Power Switch is placed in the on position.</p> |
| Controller Off |  | <p>Appears after the Startup screen displays. Indicates that the controller is turned off. Touching anywhere on the screen will turn the controller on and display the Recipe Selection screen.</p> |
| Recipe Selection |  | <p>Appears once the Controller Off screen is touched. Touch any recipe for 3 seconds to enter the programming mode. Touch the X button for 3 seconds to turn the controller off.</p> |
| Program Security |  | <p>Appears upon entering the programming mode and is used to enter a 4 digit passcode. When the controller is first powered, 0000 is used to access the programming mode. Upon subsequent access, if you don't want to use a special passcode but want to leave it 0000 just press the GO button. If you do want to use a special passcode, configure one using the Basic Setup screen. Use the left and right arrow buttons to move the cursor under the digit to be changed. The up and down arrow buttons increase or decrease the digit as desired. Touch the GO button to submit the security passcode. If the passcode is valid the Programming mode Selection screen will appear. If the passcode is invalid the Program Security screen will reappear showing the passcode you entered. Touch the X button to return to the previous screen.</p> |
| Program Mode Selection |  | <p>Appears once a valid passcode is entered from the Security screen. Touch the BASIC SETUP option to change basic controller parameters. Touch the COOK PROGRAMS option to change cook parameters for a specific recipe. Touch the X button to return to the Recipe Selection screen.</p> |
| Basic Setup |  | <p>Appears when the BASIC SETUP option is touched from the Programming Mode Selection screen. Use this screen to configure the controller to display temperature in Fahrenheit of Centigrade, to use short or long beeps at the end of a cook cycle and to modify the four digit passcode. Touch the X button to return to the previous screen.</p> |
| Recipe Edit Selection |  | <p>Appears when the COOK PROGRAMS option is touched from the Programming Mode Selection screen. This screen is used to select the recipe you want to edit. Use the up and down arrow buttons to highlight the recipe then touch the EDIT button. Touch the X button to return to the previous screen.</p> |

| Screen Name | Screen | Description |
|----------------------------|---|--|
| Recipe Parameter Selection |  | Appears when a recipe is selected and the EDIT button is touched from the Recipe Edit Selection screen. This screen is used to select a specific recipe parameter to edit. Use the up and down arrow buttons to scroll through the list of parameters and touch the parameter you want to change. Touch the X button to return to the previous screen. |
| Recipe Parameter Edit |  | Appears when a recipe parameter is touched from the Recipe Parameter Selection screen. This screen is used to edit a specific recipe parameter. The editable parameters are: Recipe name, Preheat Temp, Cook Temp, Cook Time and Hold Temp. The left and right arrow buttons are used to move the cursor under the character to be changed. The up and down arrow buttons changes the character as desired. The Preheat Temp and Hold Temp parameters can be turned off by scrolling the temperature below 150°. Touch the SAVE button to save the changed parameter. Touch the X button to abort all changes and return to the previous screen. |

Programming the Controller Using the Touchscreen Interface

Use the procedures below to edit a separate recipe or to change the basic controller configuration.

Edit a Recipe

1. Turn on the Main Power Switch. The Startup screen will briefly appear then the Controller Off screen will display.
2. Touch anywhere on the touchscreen. The Recipe Selection screen will appear displaying a list of recipes.
3. Touch any recipe for 3 seconds. The Security screen will appear.
4. Use the up/down and left/right arrow buttons to enter the passcode and touch the **GO** button. The Program Mode Selection screen will appear if a valid passcode is entered.
5. Touch the **COOK PROGRAMS** option. A Recipe Edit Selection screen will appear.
6. Highlight the recipe you want to edit using the up/down arrow buttons then touch the **EDIT** button. The Parameter Selection screen will appear.
7. Use the up/down arrow buttons to view the recipe parameters and touch the parameter you want to edit. The Parameter Edit screen will appear.
8. Change the parameter value using the left/right and up/down arrow buttons then touch the **SAVE** button to save your changes. You will return to the Parameter Selection screen.
9. Repeat the process to change any other parameters.
10. Touch the **X** button as necessary to return to the Recipe Selection screen.

Edit the Basic Setup

1. Turn on the Main Power Switch. The Startup screen will briefly appear then the Controller Off screen will display.
2. Touch anywhere on the touchscreen. The Recipe Selection screen will appear displaying a list of recipes.
3. Touch any recipe for 3 seconds. The Security screen will appear.
4. Use the up/down and left/right arrow buttons to enter the passcode and touch the **GO** button. The Program Mode Selection screen will appear if a valid passcode is entered.
5. Touch the **BASIC SETUP** option. A Basic Setup Selection screen will appear.
6. Touch the parameter that needs to be changed. A Basic Setup Parameter Edit screen appears.
7. Change the parameter value using the left/right and up/down arrow buttons then touch the **SAVE** button to save your changes. You will return to the Basic Setup Selection screen.
8. Repeat the process to change any other parameters.
9. Touch the **X** button as necessary to return to the Recipe Selection screen.

Programming the Controller Using the RS-232 Interface

The TouchTEC controller incorporates an RS-232 interface allowing factory and field personnel to read out, modify and write in the entire recipe and controller configuration using a special Controller Configuration program on a PC. The program allows a user to read the configuration data from the controller, edit any feature of the configuration, write data back to the controller, save the data to a file on the PC and to retrieve the data from a previously created file. The file saved in the PC contains a description field to aid in identifying the contents of the configuration file. Follow the steps below to program the controller using the RS-232 interface.

1. Connect the communications interface module between the serial port on the PC and the controller.
2. Start the Controller Configuration program.
3. Select the COM port that the controller will use to communicate with the PC from the pull down list in the Controller Com area.
4. Click the OPEN button and select a previously created configuration file or click the READ button to download the configuration data from the controller.
5. Edit any of the following: Description of the configuration file, Recipe Parameters, Max number of recipes visible, four digit passcode, Unit of Measurement for Temperature display and the Beep Type used at the end of the cook cycle.
6. Touch the SAVE button and save the file using a different name.
7. Touch the WRITE button to upload the new configuration data back to the controller.
8. Disconnect the the communications interface module between the serial port on the PC and the controller.

Operation with the Controller

Use the procedures below to view a separate recipe or to activate a cook cycle using a one of the preprogrammed recipes.

Viewing Recipes

1. Turn on the Main Power Switch. The Startup screen will briefly appear then the Controller Off screen will display.
2. Touch anywhere on the touchscreen. The Recipe Selection screen will appear displaying a list of recipes.
3. Use the up/down arrow buttons to highlight the recipe you wish to view then touch it. A Recipe Settings screen will appear.
4. Use the up/down arrow buttons to view any settings for the recipe selected.
5. Touch the **X** button momentarily to return to the previous screen.

Cooking

1. Turn on the Main Power Switch. The Startup screen will briefly appear then the Controller Off screen will display.
2. Touch anywhere on the touchscreen. The Recipe Selection screen will appear displaying a list of recipes.
3. Use the up/down arrow buttons to highlight the recipe you wish to use then touch the **GO** button. If a preheat temperature was programmed then the Preheat/Cook Selection screen will appear. If no preheat temperature was programmed then the controller enters the Ready To Cook mode displaying the Ready To Cook screen.
 - If the Preheat/Cook Selection screen appears, do either of the following:
 - Touch the **Preheat** option to enter the Preheat mode. The controller will display the Preheat screen. Once the preheat temperature is reached the controller enters the Ready To Cook mode.
 - Touch the **Cook** option to enter the Ready to Cook mode.

Once the temperature is within 5° of the cook temperature in the Ready To Cook mode the controller will emit three 2 second beeps indicating that the oven can be loaded with product.

4. Load the product into the oven. Use the Rotor Switch on the front panel to operate the rotors during loading.
5. Close the door.
6. Touch the **COOK** button. The controller now enters the cook mode and displays the cooking temperature, time remaining in the cook cycle and the elapsed time. If necessary, use the **EXTRA** button to add more cook time to the cycle. At the end of a cook cycle the controller will emit three 2 second beeps and enter the Hold mode and display the Hold screen if a Hold temperature was programmed. If a Hold temperature was not programmed the screen will flash and beep until touched.
7. Open the oven door and check the product for proper internal temperature. If necessary, use the **EXTRA** button to add more cook time.
8. Unload the product if it is done.

Accessory Use

Standard Meat forks

The standard meat forks are ideal for chicken and poultry. Use the following procedure to prepare the bird for loading in the oven.

1. Fold wings to back, place on back with cavity away from you.
2. Run pointed ends of meat fork through sides of chicken under wings and through thighs (breast up and legs down). Ensure that legs of adjacent birds **DO NOT PRESS TIGHTLY TOGETHER**, this will cause the area of contact to be under-cooked!
3. Load the meat-forks by holding the meat-fork with the handle to the right-hand side, facing up.
4. Open the oven door.
5. Press Rotor Switch to rotate rotor to open position if required.
6. Place the pointed ends of the meat-fork into the left-hand disc holes.
7. From the control side, push the meat-fork into the disc to allow the right-hand (handle end) pins locate into the right-hand disc.
8. Be sure to adjust the meat-fork position so that the handle end locates firmly in the spit groove.

Baskets

Baskets can be used for large chickens or other meats. After loading with product, simply locate pins in the holes on the discs.

CO Operation

Controls and Indicators

Refer to the figure and table below for an explanation of controls and indicators.

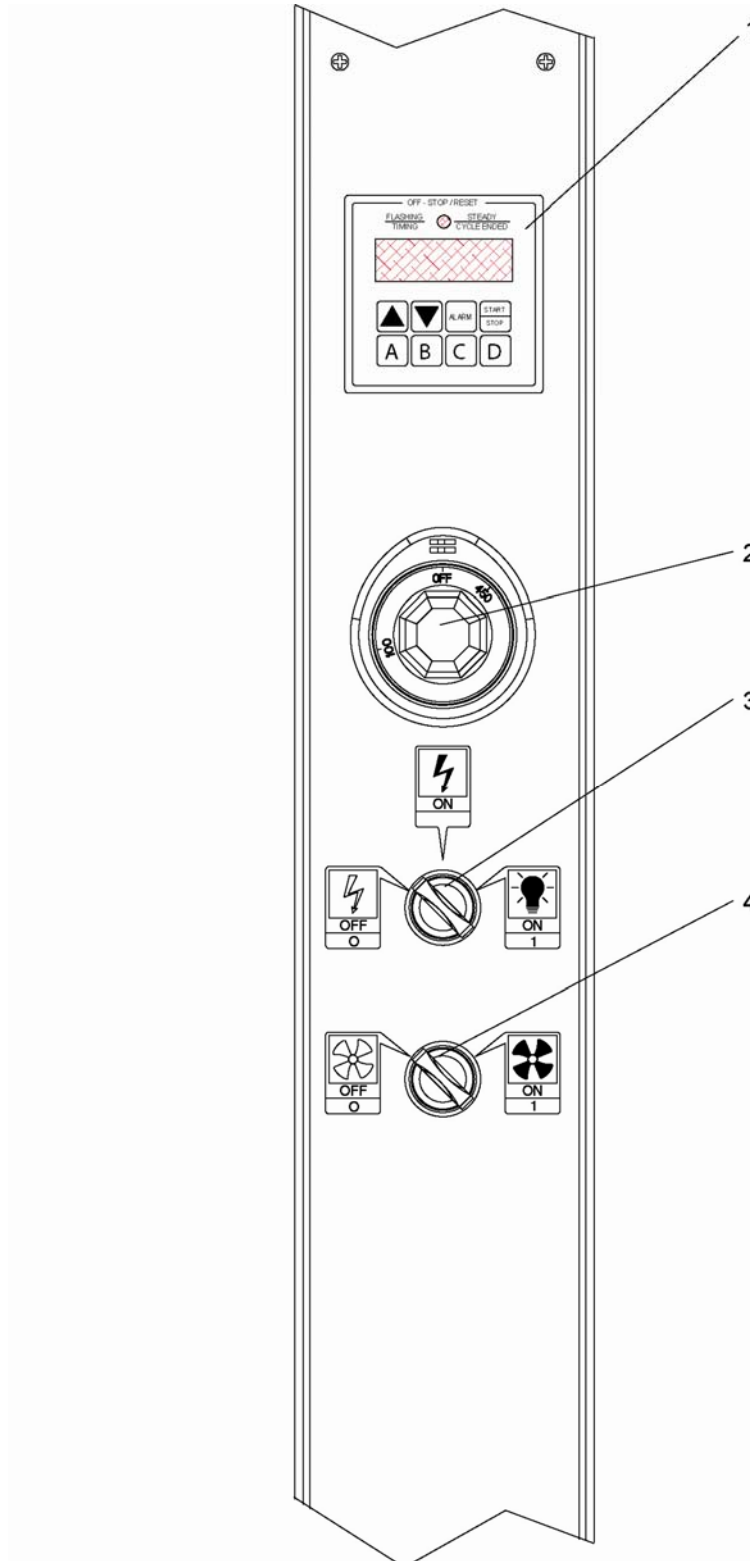

| Item # | Description | Function |
|--------|---------------|---|
| 1 | Digital Timer | <p>The digital timer consists of an LED, display, beeper and 8 buttons described below:</p> <p>LED indicator – Prior to the start of a timing cycle the LED will be OFF. When running a timing cycle the LED will flash. At the end of a timing cycle the LED will turn ON steady. When idle the LED is off.</p> <p>TIME SELECT (2 arrow buttons) – Two arrow buttons on the front panel are used to set the time. Hold the UP ARROW button down to increase the time. The longer the button is held down, the faster the rate at which the time will increase. The DOWN ARROW button is used in the same manner as the UP ARROW button except it will cause the time to decrease. The time is increased or decreased in 30-second increments.</p> <p>START/STOP button Starting the Timer - Pressing this button while the timer is not active will cause the timer to begin counting down the time on the display. Stopping the Timer - Pressing this button while the timer is active will stop the timer from counting down and display the remaining time. Time cannot be changed with the TIME SELECT buttons at this point. If this button is pressed again the timer will continue counting down from the point it was stopped. Resetting the Timer - Pressing and holding this button for longer than two (2) seconds will reset the timer and the display will return to the original starting time. At this point, time can be changed using the TIME SELECT buttons or the preset buttons.</p> <p>ALARM button - This button allows the user to set an elapsed time at which the internal alarm will sound during a cycle. The time is set by pressing and holding the ALARM button while using the UP and DOWN arrows to change the time. The controller will limit the alarm time to be less than the currently programmed interval cycle time. The default alarm time is 0:00 which disables it. The ALARM time is saved on power down in the same manner as the last interval time. When a time cycle is running and the alarm time has elapsed the internal alarm will sound for 10 seconds. For example, a cycle time 10:00 and alarm time of 2:00 would cause the alarm to sound for 10 seconds once the controller has counted down from 10:00 to 8:00.</p> <p>A, B, C, D preset buttons - These buttons are used to save and recall preset cycle and alarm times, saving operator time and minimizing error when changing interval cycle times and alarm times. To save the current interval and alarm times into one of the preset locations, press and hold the A, B, C, or D preset button for 2 seconds and the controller will double chirp to indicate the times have been saved. To recall any preset time, press and quickly release the appropriate button and the time values are loaded and displayed.</p> <p>Beeper – A beeper sounds when the timer counts down to 0. Pressing the START/STOP button stops the beeper and resets the timer causing the display to return to the original starting time. At this point, time can be changed using the TIME SELECT buttons or the preset buttons. The beeper will also sound for 10 seconds if the alarm time has elapsed during a timing cycle.</p> <p>Display – Used to display the time.</p> |
| 2 | Thermostat | <p>Used to set the cook temperature. Turn the thermostat knob clockwise to the desired cook temperature. A light will turn on when the thermostat calls for heat. The light will turn off when the temperature is reached.</p> |

| Item # | Description | Function |
|--------|---------------------------------|---|
| 3 | Power/Light Switch (3 position) | Used to turn the oven power and lights ON (1) or OFF (0). Place the knob in the center position to power the oven. Place the knob in the fully clockwise position to power the oven and the lights. Place the knob in the fully counterclockwise position to turn the oven off. |
| 4 | Blower Switch (2 position) | Used to turn the fan on providing optimum air circulation for even baking. Place the knob in the fully clockwise position to turn on the fan. The fan is automatically turned off when the door is opened. |

Operating the Oven

1. Place the Power/Light switch in the fully clockwise position. This will apply power to the oven and turn the lights on.
2. Place the Blower switch in the ON (1) position.
3. Press and hold the TIME SELECT arrow buttons on the digital timer until the desired cook time is displayed or recall a preset time by quickly pressing the appropriate preset button.
4. Pre-heat the oven by setting the thermostat to the desired temperature. The thermostat light will turn off when the temperature is reached.
5. Open the door and load product into oven once the oven has pre-heated. **NOTE:** Keep oven door closed when not loading oven to avoid a sharp decline in oven temperature.
6. Activate the timer by pressing the START/STOP button on the digital timer. The timer will begin to count down.
7. When the timer has counts down to 0, the digital timer beeper will sound. Press the START/STOP button.
8. Using your oven mitts, open the door and unload the product.
9. Place the Blower switch in the OFF (0) position.
10. Place the Power/Light switch in the fully counterclockwise position OFF (0).

Cooking Suggestions

Most recipes can be adjusted for convection oven use by decreasing the temperature by 25° F and decreasing cooking time about 25%. Dishes with cooking times over 45 minutes and that might dry out too much (like lasagna, or meatloaf) should be covered for the first half of the cooking time.

Maintenance

⚠ CAUTION

Failure to comply with the maintenance below could result in a serious accident or equipment damage.

⚠ DANGER

Failure to remove power from this unit before performing maintenance may cause severe electrical shock. This unit may have more than one disconnect switch.

Scheduled Maintenance

VGG Oven Cleaning (Daily)

Cleaning is not only necessary for sanitary reasons, but will increase sales appeal and maximize operating efficiency.

⚠ DANGER

Failure to remove power from this unit may cause severe electrical shock. This unit may have more than one disconnect switch.

⚠ CAUTION

Always wear appropriate personal protection equipment during the cleaning process to guard against possible injury.

Using abrasive cleaners may damage the cabinet finish. Use only a mild soap and water solution.

DO NOT USE OVEN CLEANER on this machine. Caustic cleaners can cause damage to the machine.

Never steam clean or get excess water in the interior of the cabinet as this can damage unit.

This appliance is not intended to be cleaned with a water jet.

1. Allow oven to cool below **50° C (120° F)**.
2. Turn the Main Power Switch off and disconnect from the Main Power Isolator (Circuit Breaker).
3. Empty the grease drawer using the drain valve or fat pump.
4. Remove all food products from the unit.
5. Remove V-spits, meat forks, hanging baskets and drip trays from the unit and place them in a large sink to soak in hot cleaning solution. Clean the components with warm water, a sponge and **BKI** Cleaner. Wipe dry with a clean cloth.

6. Remove the Rotor System as described below:
 - a. Lift the washer from the groove and slide down the shaft.
 - b. Slide each rotor cup down the shaft.
 - c. Remove the inner shaft.

NOTE: The welded bead in the center of shaft denotes the shaft removal direction.
 - d. Remove rotors.
7. Place the Rotor System components in a large sink to soak in hot cleaning solution. Clean the components with warm water, a sponge and **BKI** Cleaner. Wipe dry with a clean cloth.
8. Remove the Fan Guard, Circulation Bottom and Fan Blades as described below:
 - a. Unfasten (counterclockwise) each 1/4 turn latch on the Fan Guard and remove from oven.

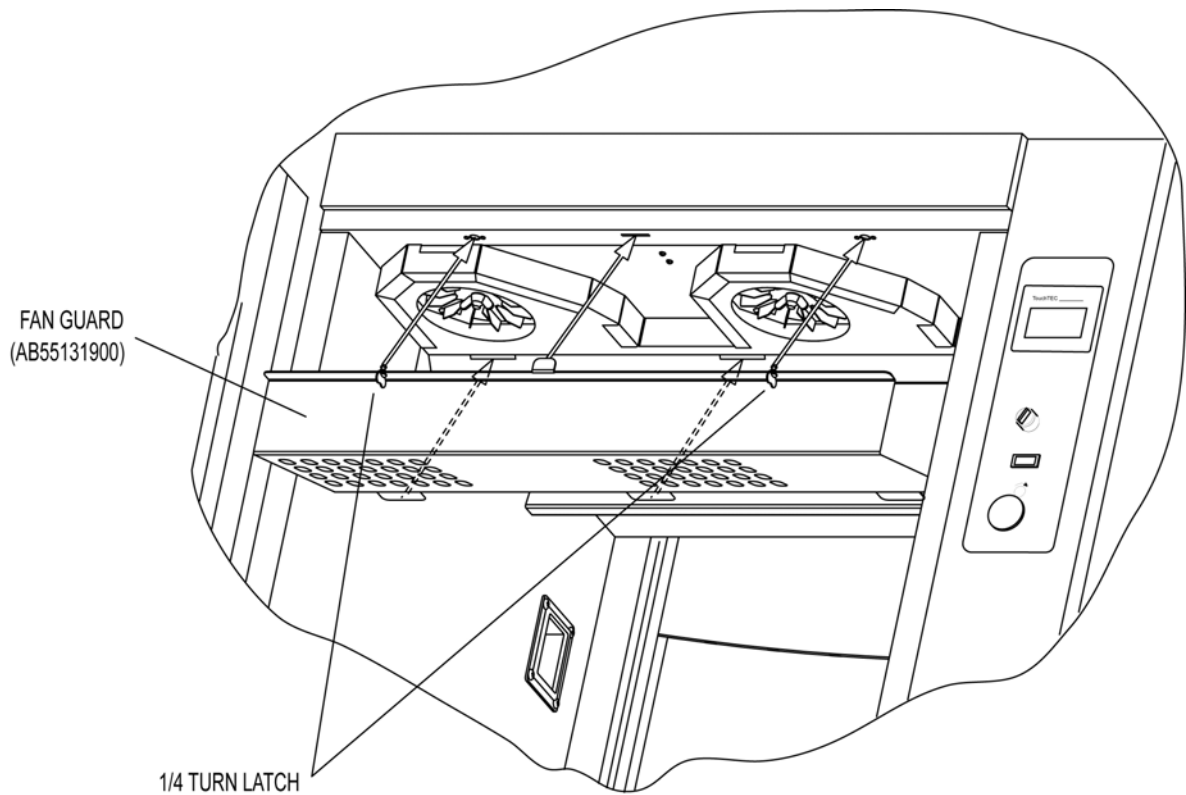

- b. Pull Circulation Bottom out of oven then unscrew (clockwise) the wing nut on each Blower Fan to remove the fan blades.

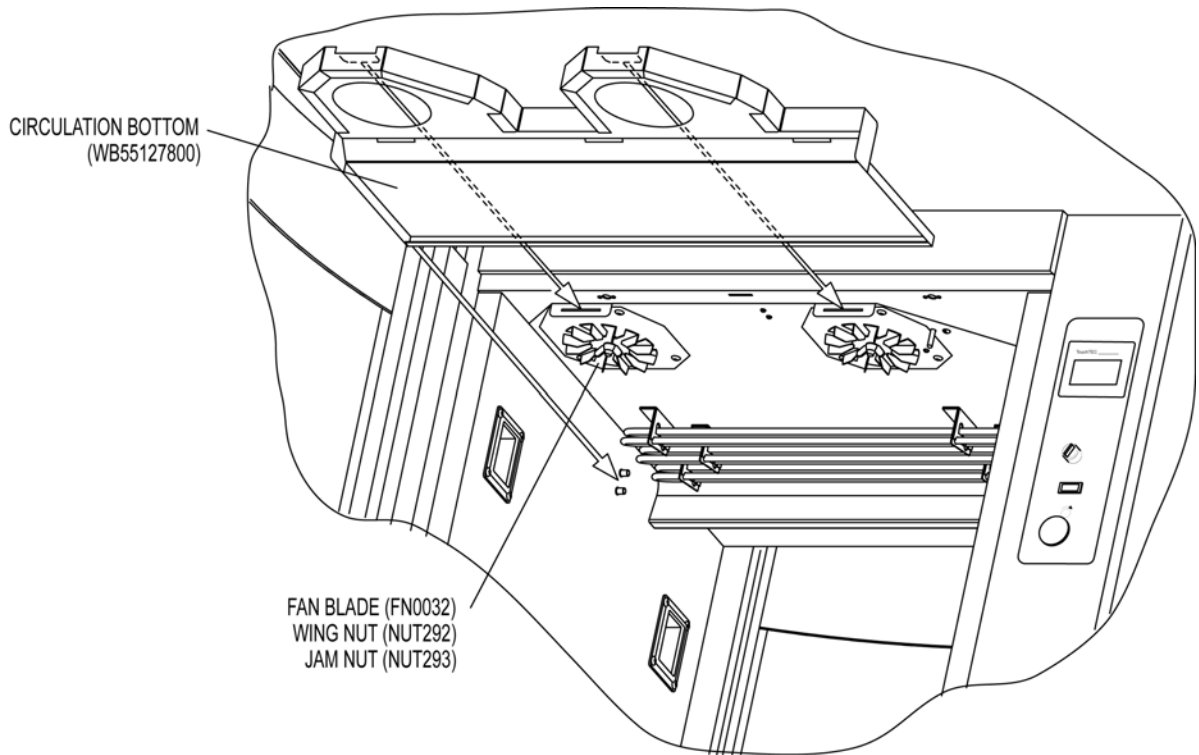

9. Place the Fan Guard and Circulation Bottom in a large sink to soak in hot cleaning solution. Clean the components with warm water, a sponge and **BKI** Cleaner. Wipe dry with a clean cloth.
10. Carefully clean the fan blades using a scrub brush and hot cleaning solution. Do not bend or disfigure the fan blades.
11. Clean the top of oven. Carefully clean around fan and surrounding areas.
12. Clean grease drawer and tray area with hot soapy water.
13. Replace the grease drawer.
14. Clean the outside and inside of the rotisserie oven with warm water, a sponge and an approved cleaner which is authorized for use on food surface areas.
15. Reassemble the oven.

CO Oven Cleaning

The oven must be cleaned at the end of each business day. It is easier to clean while still warm. Cleaning is not only necessary for sanitary reasons, but will increase sales appeal and maximize operating efficiency.

DANGER

Failure to remove power from this unit may cause severe electrical shock. This unit may have more than one disconnect switch.

CAUTION

Using abrasive cleaners may damage the oven finish. Use only a mild soap and water solution.

Never steam clean or get excess water in the interior of the oven as this can damage unit.

DO NOT USE OVEN CLEANER on this machine. Caustic cleaners can cause damage to the machine.

Always wear appropriate personal protection equipment during the cleaning process to guard against possible injury from hot cleaning solution.

1. Place the Power/Light switch in the fully counterclockwise position OFF (0).
2. Turn the circuit breaker off that supplies power to the oven.
3. Wearing your insulated mitts, remove all products from the unit. Remove all food pans, racks and inside bottom pan from the unit and place them in a large sink to soak in hot cleaning solution (BKI Cleaner).
4. Allow the unit to cool to room temperature before proceeding.
5. Lift the left-side tray rack off of its mounting brackets and out of the oven. Repeat this for the right-side tray rack. Place the tray racks in a large sink to soak in hot cleaning solution (BKI Cleaner).
6. Slide the bottom of the inside blower cabinet forward and remove from oven. Place in a large sink to soak in hot cleaning solution (BKI Cleaner).
7. Slide the bottom of the left side insert assembly to the center of the oven and remove from oven. Place the assembly in a large sink to soak in hot cleaning solution (BKI Cleaner).
8. Slide the bottom of the right side insert assembly to the center of the oven and remove from oven. Place the assembly in a large sink to soak in hot cleaning solution (BKI Cleaner).
9. Clean the outside of the oven with warm water, a sponge and approved cleaner which is authorized for use on food surface areas.
10. Wipe the unit dry with a soft cloth.
11. Finish cleaning the parts, wipe dry and reassemble the oven.

Troubleshooting

VGG

| Problem | Cause | Possible Solution |
|--|---|--|
| Unit will not turn on. Main Power Isolator Light is not lit. | Unit power plug disconnected (where applicable). | Plug unit into mating receptacle. |
| | Problem with building power supply | Check circuit breaker at building power panel. If problem persists, contact BKI service agent for corrective action. |
| Unit will not turn on. Main Power Isolator Light is lit. | Blown Fuse | Contact BKI service agent for corrective action. |
| | Safety cut out thermostat tripped or defective. | Contact BKI service agent for corrective action. |
| | Defective contactor. | Contact BKI service agent for corrective action. |
| Rotor not rotating. | Door not completely closed. | Check that both doors are completely closed |
| | Defective door switch. | Contact BKI service agent for corrective action. |
| | Blown Fuse | Contact BKI service agent for corrective action. |
| | Defective contactor. | Contact BKI service agent for corrective action. |
| | Defective motor or capacitor. | Contact BKI service agent for corrective action. |
| Rotor will not rotate while depressing Rotor switch with door open but operates with doors closed. | Defective rotor switch. | Contact BKI service agent for corrective action. |
| Oven does not heat at all. | Improper program settings. | Check program settings. |
| | Improper parameter settings. | Contact BKI service agent for corrective action. |
| | Fan cover & circulation bottom not installed or improperly installed. | Check that components are properly installed. |
| | Fan cover switch defective. | Contact BKI service agent for corrective action. |
| | Defective controller or contactor. | Contact BKI service agent for corrective action. |
| | Heating elements not functioning. | Contact BKI service agent for corrective action. |
| Oven heats up slowly | Improper line voltage. | Contact BKI service agent for corrective action. |

| Problem | Cause | Possible Solution |
|---|--|--|
| | Defective blower fan motor. | Contact BKI service agent for corrective action. |
| | Defective heating element. | Contact BKI service agent for corrective action. |
| Control displays “999” under the temperature display. | Temperature probe connection loose or defective probe. | Contact BKI service agent for corrective action. |
| Cavity lights do not illuminate when unit is on. | Blown fuse. | Contact BKI service agent for corrective action. |
| Individual cavity lamp does not illuminate. | Defective bulb. | Contact BKI service agent for corrective action. |

CO

| Problem | Cause | Possible Solution |
|--|---|---|
| Unit will not turn on | Oven is not connected to power source. | Have a licensed electrician connect the oven to an appropriate power source. |
| | Power to unit is not on. Problem with building power panel, circuit breaker/fuse or receptacle. | Check circuit breaker or fuses at building power panel. If problem persists, contact a licensed electrician. |
| | Blown fuse on unit. | Contact an authorized BKI service agent for corrective action. |
| | Defective power switch. | Contact an authorized BKI service agent for corrective action. |
| Unit operates for a period of time, then, the oven shuts down. | Problem with building power panel, circuit breaker/fuse or receptacle. | Check circuit breaker or fuses at building power panel. If problem persists, contact a licensed electrician. |
| | Defective over-temperature switch. | Contact an authorized BKI service agent for corrective action. |
| Oven does not heat at all. | Blower fan stopped. | Check that blower switch is on. If problem persists, contact an authorized BKI service agent for corrective action. |
| | Loose wire on heater circuit. | Contact an authorized BKI service agent for corrective action. |
| | Defective relay. | Contact an authorized BKI service agent for corrective action. |
| | Heating elements not functioning. | Contact an authorized BKI service agent for corrective action. |
| Oven has very slow heat up or recovery. | Heating elements not functioning. | Contact an authorized BKI service agent for corrective action. |

| Problem | Cause | Possible Solution |
|--------------------------------------|---|--|
| Oven will not come up to temperature | Improper thermostat setting. | Check temperature setting. |
| | Failed heating element or blower fan. | Contact an authorized BKI service agent for corrective action. |
| Product not cooked thoroughly | Oven not preheated. | Be sure to preheat the oven before placing product in oven. |
| | Door left open. | Keep door closed when not loading oven. |
| | Improper time or temperature. | Check for proper time and temperature setting. |
| | Failed heating element, thermostat or blower fan. | Contact an authorized BKI service agent for corrective action. |

Notes



P.O. Box 80400, Simpsonville, S.C. 29680-0400, USA
<http://www.bkideas.com>

Made and printed in the U.S.A
LI0132/0407