

Cat. No. 43-469
OWNER'S MANUAL

Please read before using this equipment.

ET-469

**Two-Line Speakerphone with
Line Status Indicators**

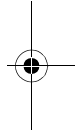
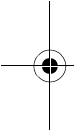

RadioShack®

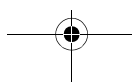
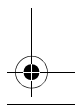
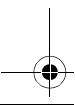

FEATURES

Your RadioShack ET-469 Two-Line Speakerphone lets you place or receive calls from two separate telephone lines. The phone's Line Status Indicators show you which line is available, in use, or on hold.

Your system's features include:

Conference Calling — lets you conduct 3-way conversations with two callers.

Speakerphone — allows hands-free telephone conversations.

Memory Dialing — lets you store up to 20 numbers in memory so you can quickly dial them.

Hold Button — lets you put a call on hold so you can answer another one.

Flash — sends an electronic switch-hook signal for use with special phone services such as Call Waiting.

Redial — lets you quickly dial the last dialed number with the press of a button.

Privacy — lets you talk to someone else in the room without being overheard by the person(s) on the phone.

Headset Jack — lets you connect an optional headset for added convenience.

Volume Control — lets you control the volume of the sound you hear through the handset, speakerphone, or headset.

Touch-Tone (DTMF) or Pulse Dialing — lets you use your phone with either type of service.

Hearing Aid Compatible — lets you use your telephone with hearing aids that have a T (telephone) switch.

Ringer Controls — let you turn off the ringer or control its volume for each line.



Note: Your local phone company might offer special phone services such as Rollover, Hunt, or Call Forwarding which can be set up for the two lines connected to this phone. These services switch incoming calls from one line to another. Contact your local phone company for more information about these services.

This telephone has been tested and found to comply with all applicable UL and FCC standards.

We recommend you record your phone's serial number here. The number is on the bottom of the phone.

Serial Number _____

WARNING: To reduce the risk of fire or shock hazard, do not expose this product to rain or moisture.

	CAUTION RISK OF ELECTRIC SHOCK. DO NOT OPEN.	
CAUTION: TO REDUCE THE RISK OF ELECTRIC SHOCK, DO NOT REMOVE COVER OR BACK. NO USER-SERVICEABLE PARTS INSIDE. REFER SERVICING TO QUALIFIED PERSONNEL.		



This symbol is intended to alert you to the presence of uninsulated dangerous voltage within the product's enclosure that might be of sufficient magnitude to constitute a risk of electric shock. Do not open the product's case.



This symbol is intended to inform you that important operating and maintenance instructions are included in the literature accompanying this product.

READ THIS BEFORE INSTALLATION

This telephone conforms to federal regulations, and you can connect it to most telephone lines. However, each device that you connect to the phone line draws power from the phone line. We refer to this power draw as the device's *ringer equivalence number*, or REN. The REN is on the bottom of the phone.

If you are using more than one phone or other device on the line, add up all the RENs. If the total is more than five (or three in rural areas), your phones might not ring. If ringer operation is impaired, remove a device from the line.

FCC STATEMENT

This telephone complies with Part 68 of *FCC Rules*. You must, upon request, provide the FCC registration number and the REN to your phone company. These numbers are on the bottom of the phone.

Note: You must not connect the telephone to:

- coin-operated systems
- party-line systems
- most electronic key phone systems

CONTENTS

Installation	5
Choosing a Location	5
Mounting the Phone	5
On a Desktop	5
On a Wall-Plate	7
On a Wall	8
Connecting the Handset Cord	9
Preparation	10
Line Status Indicators	10
Adjusting the Line Status Indicators	10
Disabling Line 2	11
Setting the Dialing Mode	11
Setting the Ringer	11
Confirming the Line Numbers	11
Basic Operation	12
Using the Speakerphone	12
Switching Between the Handset and the Speakerphone	13
Adjusting the Volume	13
Using HOLD	13
Using PRIVACY	14
Using FLASH	14
Using REDIAL	14
Conference Calling	14
Using Tone Services on a Pulse Line	15
Special Features	16
Using Memory Dialing	16
Storing a Number in Memory	16
Storing a Pause in Memory	17
Dialing a Stored Number	17
Chain Dialing Service Numbers	17
Testing Stored Emergency Numbers	17
Using the Phone Number Index Card	18
Connecting an Optional Headset	18
Troubleshooting	19
Care and Maintenance	20
The FCC Wants You to Know	21
Lightning	21

INSTALLATION

CHOOSING A LOCATION

You can use your telephone as a desk phone, mount it on a standard wall plate, or mount it directly on a wall. Select a location that is near the telephone line jack(s) and an easily accessible AC outlet.

To take full advantage of many of the ET-469's features (like conference calling) you must have two telephone lines with separate phone numbers. If you have only one phone line, you can order a second line from your local phone company.

You can use a two-line jack (RJ14C or RJ14W for a wall plate) that contains both lines, or you can use a separate single-line jack (RJ11C) for each line.

Notes:

- The line that connects the phone jack to the telephone company wiring must be twisted-pair cable. Otherwise, you might experience interference (crosstalk) between the two phone lines.
- Your telephone connects directly to a modular telephone line jack. If your telephone wiring does not have a modular jack, you can update the wiring yourself using jacks and adapters available at your local RadioShack store, or have the telephone company update the wiring for you.

MOUNTING THE PHONE

On a Desktop

1. Remove the mounting bracket by holding in the tab on the right side of the bracket and gently pulling the bracket away from the base.

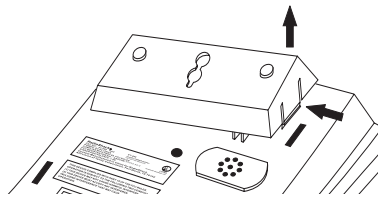

2. If you have a single two-line phone jack, plug one end of the supplied two-line long modular cord into **L1** or **L1/L2** on the back of the phone's base.

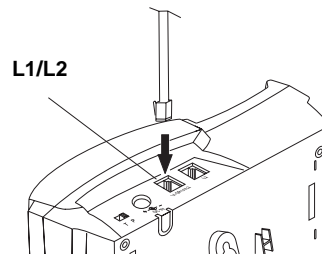

Note: If you connect the phone to a two-line phone jack with a two-line cord, do not connect another modular cord to the **L2** jack. Otherwise, the phone will not operate properly.

If you have two separate one-line modular jacks, plug one end of the supplied two-line long modular cord into **L1 or L1/L2** and plug the supplied one-line long modular cord into **L2**.

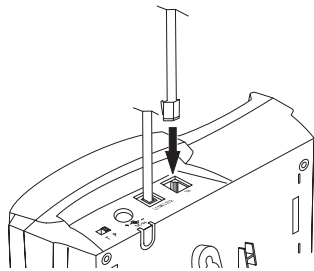

3. Insert the supplied AC adapter's barrel plug into the **DC 9V** jack on the back of the phone.

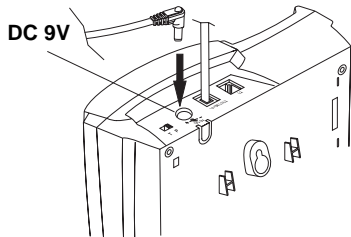

Caution: You must use a Class 2 power source that supplies 9 volts DC and delivers at least 150 mA. Its center tip must be set to negative and its plug must fit the TAD-469's **DC 9V** jack. The supplied adapter meets these specifications. Using an adapter that does not meet these specifications could damage the TAD-469 or the adapter.

4. Route the adapter's cord through the strain relief slot on the back of the phone.

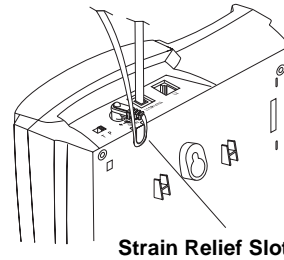

5. Insert the bracket's two small tabs into the matching slots at the upper left on the bottom of the phone, and snap the large tab of the bracket into the large slot at the upper right.

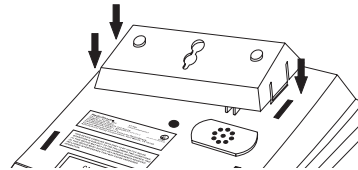

6. Connect the other end(s) of the phone cord(s) to the phone line jack(s).

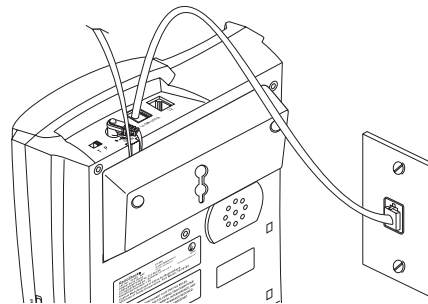

7. Plug the AC adapter into a standard AC outlet.

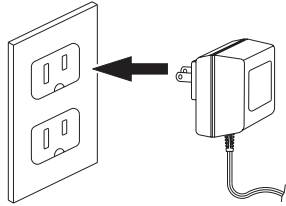

On a Wall-Plate

1. Remove the bracket by pressing and holding in the tab on the right side of the bracket, then gently pulling the bracket away from the base.

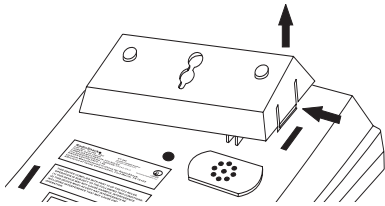

2. Insert the bracket's two small tabs into the matching slots at the lower right on the bottom of the phone, and snap the large tab into the large slot at the lower left.

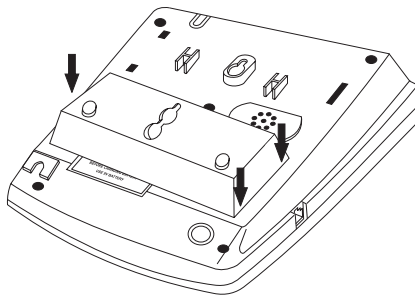

3. If the wall plate has a single two-line phone jack, plug one end of the supplied two-line short modular cord into **L1 or L1/L2** on the back of the phone's base.

If the wall plate has a single one-line phone jack, and there is another telephone jack close by, plug one end of the supplied two-line short phone cord into **L1 or L1/L2**, and plug the supplied one-line long phone cord into **L2**.

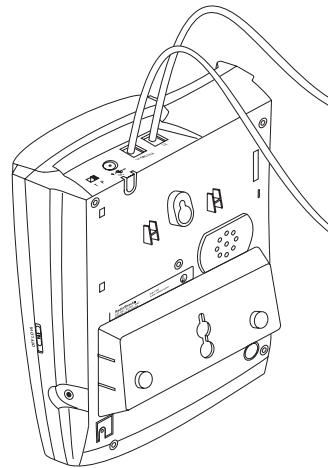

4. Insert the supplied AC adapter's barrel plug into the **DC 9V** jack on the back of the phone.

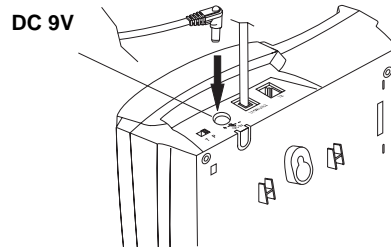

5. Plug the other end of the two-line short modular cord into the wall plate jack. If you attached a long modular cord, plug it into the wall jack. Align the wall plate studs with the phone's keyhole slots and slide the phone downward to secure it.
6. Plug the adapter into a standard AC outlet.

On a Wall

To mount your phone on a wall, you need two screws (not supplied) with heads that fit into the keyhole slots on the bottom of the phone.

1. Drill two holes $3^{15}/16$ inches (100 mm) apart. Then, thread a screw into each hole, letting the heads extend about $3/16$ inch (5 mm) from the wall.

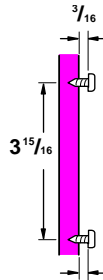

2. Remove the bracket by holding in the tab on the right side of the bracket and gently pulling the bracket away from the base.

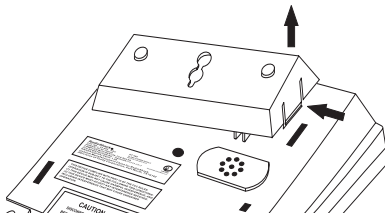

3. Insert the bracket's two small tabs into the matching slots at the lower right on the bottom of the phone,

and snap the large tab into the large slot at the lower left.

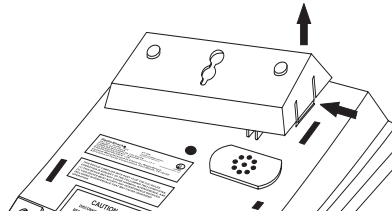

4. If you have a single two-line phone jack, plug one end of the supplied two-line short modular cord into **L1** or **L1/L2** on the back of the phone's base.

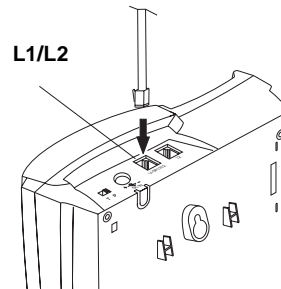

If you have a single one-line phone jack, and there is another modular telephone line jack close by, plug one end of the supplied two-line short phone cord into **L1** or **L1/L2**, and plug the supplied one-line long phone cord into **L2**.

5. Insert the supplied AC adapter's barrel plug into the **DC 9V** jack on the back of the phone.

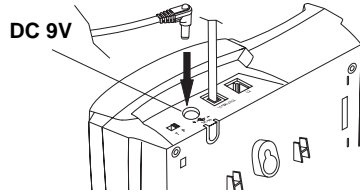

6. Plug the other end of the two-line short modular cord into one of the wall jacks. If you attached a long modular cord, plug it into the other wall jack. Align the screws on the wall jack. Align the screws on the wall with the phone's keyhole slots and slide the phone downward to secure it.
7. Plug the adapter into a standard AC outlet

CONNECTING THE HANDSET CORD

Plug the supplied coiled handset cord into the jacks on the handset and the left side of the phone.

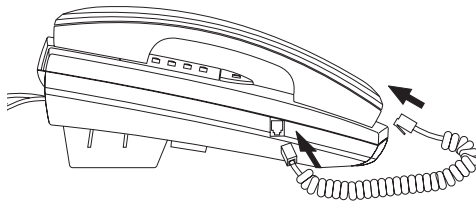

Note: Your local RadioShack store sells a variety of longer coiled handset cords, which are especially useful when you mount the phone on the wall.

PREPARATION

LINE STATUS INDICATORS

The Line Status Indicators show you which line is in use or on hold. If a line is on hold, the indicator light flashes. If a line is in use, the indicator lights.

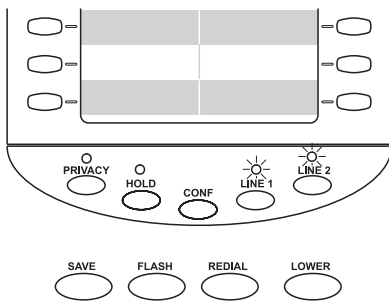

Indicator is:	Line is:
Off	Not in use
On Steadily	In use
Flashing rapidly	Ringing
Flashing slowly	On hold

Adjusting the Line Status Indicators

Each line status indicator is preset to work correctly with most telephone lines. However, if an indicator does not light when its line is in use, you may need to adjust the indicator to ensure correct operation.

Follow these steps to test and adjust the Line Status Indicators.

1. Press **LINE 1** then lift the handset. The **LINE 1** indicator should light steadily.
2. Press **HOLD**. The indicator should flash slowly.
3. If the indicator worked correctly, it does not need adjustment. Otherwise, proceed to Step 4.
4. Slide the phone's name and number index card and plastic cover out of its slot and remove it. Locate the **L1** control.

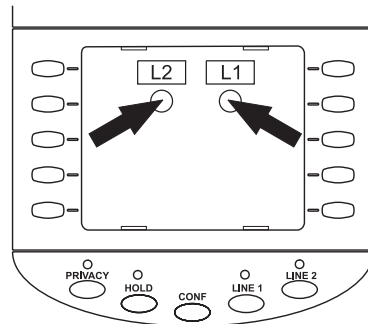

5. Press **HOLD** and insert the supplied flat-blade screwdriver into the indicator control slot and turn in either direction until the line indicator flashes slowly.
6. Press **LINE 1**. If the indicator flashes slowly, turn the **L1** control until the indicator lights steadily.
7. Press **HOLD** again and repeat Steps 4 and 5 until the indicator works correctly with the line on and off hold.

Repeat these steps to adjust **L2**.

DISABLING LINE 2

Should you ever need to disable Line 2, leave the handset in the cradle and press **HOLD, LINE 2**, then *****.

To enable the Line 2 indicator, leave the handset in the cradle and press **HOLD, LINE 2**, then **#**.

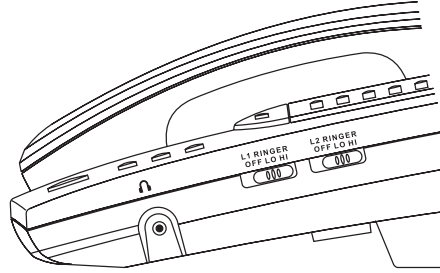

SETTING THE DIALING MODE

Set **T/P** (Tone/Pulse) on the back of the phone for the type of service you have. If you are not sure which type you have, do this test.

1. Press **LINE 1**.
2. Set **T/P** to **T**.
3. Press any number other than **0**.

If the dial tone stops, you have touch tone service. Leave **T/P** set to **T**.

If the tone continues, you have pulse service. Set **T/P** to **P**.

If you do not want a line's ringer to sound, set **RINGER OFF/LO/Hi** for that line to **OFF**. The line indicator will light when a call comes in. You can still receive and make calls on that line.

CONFIRMING THE LINE NUMBERS

Follow these steps to determine which phone number is connected to which line.

1. Press **LINE 1** then lift the handset.
2. Dial one of your phone numbers. If the Line 2 indicator flashes, the number is connected to Line 2. If you hear a busy signal, the number is connected to Line 1.

SETTING THE RINGER

The lines on your phone ring with different tones when you receive a call. You can set the phone lines to ring at the same volume, at different volumes, or not at all.

To set each ringer's volume, set **RINGER OFF/LO/Hi** for that line to the desired position.

After you confirm the phone number for each line, write each number on the name and number directory located above the **L1** and **L2** buttons.

BASIC OPERATION

To make a call, pick up the handset and select a line by pressing **LINE 1** or **LINE 2**. When you hear the dial tone, dial the number.

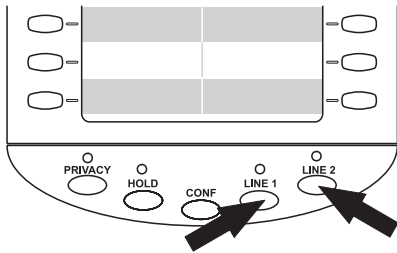

Notes:

- The phone automatically selects the free line if you do not press **LINE 1** or **LINE 2**.
- If you do not select a line before picking up the handset, the free line activates.

When you receive a call on a line, the indicator for that line flashes and the phone rings (if **RINGER** is set to **LO** or **HI**). To answer the call, press the ringing line's button (**LINE 1** or **LINE 2**) and pick up the handset.

To help you tell which line is ringing, each line has a distinctive ring tone. Line 1 has a higher tone than Line 2.

Note: Line 2 does not operate during a power failure.

USING THE SPEAKERPHONE

To make or answer a call using the speakerphone, press **HEADSET/SPEAKER**. The **SPEAKER** indicator lights and the phone automatically selects a free line or the line that is ringing. To make a call or answer on the other line, press the line's button (**LINE 1** or **LINE 2**).

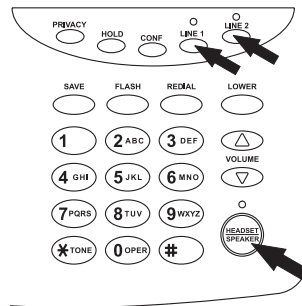

To end a speakerphone call, press **HEADSET/SPEAKER**. The **SPEAKER** indicator turns off.

Notes:

- If background noise interferes with the speakerphone's operation, you can press **PRIVACY** to turn off the base's microphone while the other party is speaking (see "Using Privacy" on Page 14).
- You cannot use the speakerphone with a headset connected to the phone (see "Connecting an Optional Headset" on Page 18).
- You cannot use the speakerphone during a power failure.

Switching Between the Handset and the Speakerphone

To switch from the handset to the speakerphone at any time during a call, press **HEADSET/SPEAKER** so its red indicator lights, then resume the conversation.

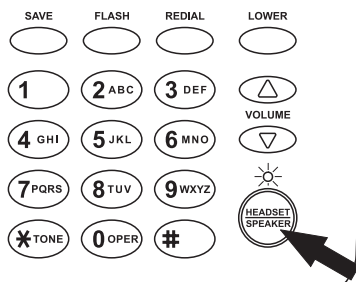

To switch from the speakerphone to the handset, just lift the handset and resume your conversation. The **SPEAKER** indicator turns off.

ADJUSTING THE VOLUME

To increase or decrease the volume when using the speakerphone, handset, or connected headset, press **VOLUME ▲** or **▼**.

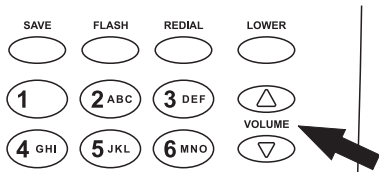

USING HOLD

To place a call on hold, press **HOLD**. You can then hang up the handset or use the other phone line (to answer another call, for example) without disconnecting the current call.

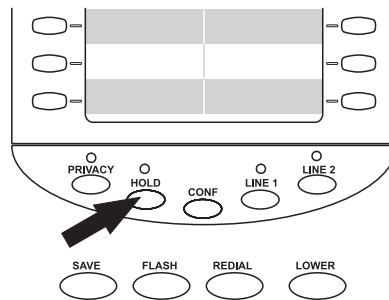

To pick up a line that is on hold, press that line's button (Line 1 or Line 2).

Notes:

- You can put a call on hold at one extension and pick up the call at another extension.
- You can alternate between two lines by pressing **HOLD** to put your current line on hold, then pressing the button for the line you want to pick up.
- If you press the other line's button without first pressing **HOLD**, the first call disconnects.

USING PRIVACY

If you do not want the person on the other end of the phone line to hear your conversation with someone else at your location, press **PRIVACY**. The **PRIVACY** indicator lights and the microphone turns off, but you can still hear the calling party. Press **PRIVACY** again to resume your conversation.

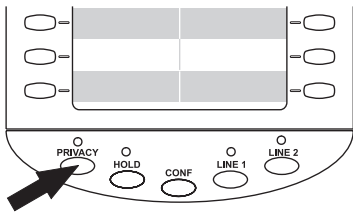

USING FLASH

Use **FLASH** to perform the switchhook operation for special phone services, such as Call Waiting.

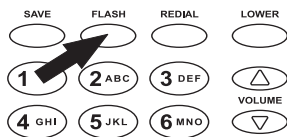

For example, if you have Call Waiting, press **FLASH** to take an incoming call without disconnecting the current call. Press **FLASH** again to return to the first call.

Note: If you do not have any special phone services, pressing **FLASH** might disconnect the current call.

USING REDIAL

You can quickly redial the last number dialed from the selected line.

To use redial with the handset, lift the handset then press **REDIAL** when you hear the dial tone.

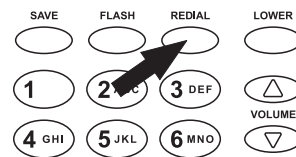

To use redial with the speakerphone, press **HEADSET/SPEAKER** then **REDIAL**.

Notes:

- The redial memory holds up to 31 digits, so you can redial long-distance as well as local phone numbers.
- When you redial a phone number that includes a **FLASH** entry, the phone only redials the numbers you pressed before **FLASH**.

CONFERENCE CALLING

Conference calling lets you conduct a 3-way conversation, joining Line 1 and Line 2 into one phone call. To place a conference call, follow these steps.

1. Place a call to one party.

2. Press **HOLD** to put the first call on hold.

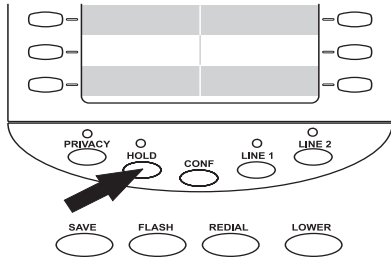

3. Press either **LINE 1** or **LINE 2** for the line not in use, then place a call to another party.

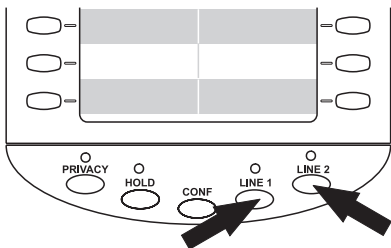

4. After the second party answers, press **CONF**. This connects all three parties.

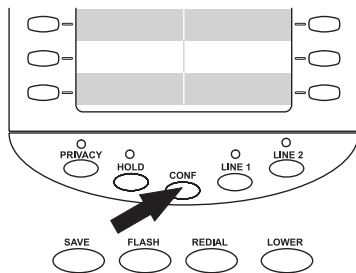

Note: To talk on only one line without disconnecting the other line, press **HOLD**. Both lines' red indicators flash. Then, press the button for the line you want to talk on. To

return to the three-way conversation, press **CONF**.

5. To end the conference call with both lines, hang up the handset.

To disconnect one line and continue talking on the other, press either **LINE 1** or **LINE 2**.

USING TONE SERVICES ON A PULSE LINE

Some special services, such as bank-by-phone, require tone signals. If you have pulse service, you can still use these special tone services by following these steps.

1. Set **T/P** (Tone/Pause) at the back of the base to **P**.

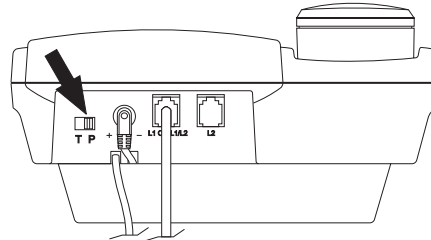

2. Dial the service's main number.
3. When the service answers, press *****. Any additional numbers you dial are sent as tone signals.
4. After you complete the call, hang up. The phone automatically resets to the pulse mode.

SPECIAL FEATURES

USING MEMORY DIALING

You can store up to 20 numbers in the speakerphone's memory and dial a stored number at the press of a few buttons. Each stored number can be up to 24 digits.

Storing a Number in Memory

Each of the phone's 10 memory locations can hold up to 2 phone numbers; one each in an upper and lower memory location.

Follow these steps to store a number in memory.

Note: To prevent unauthorized access to special services, we recommend you do not store a personal identification number in memory.

1. Lift the handset from the cradle or press **HEADSET/SPEAKER**.
2. Press **SAVE**.

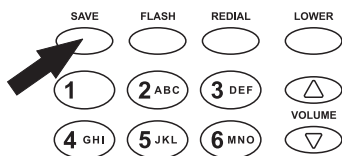

3. Enter the phone number you want to store (up to 24 digits, including any **PAUSE** entries). (See "Storing a Pause in Memory" on Page 17.)

Notes:

- Each pause entry counts as one memory digit.
- If you make a mistake while entering the number, start again at Step 1.

4. Press **SAVE**.
5. Select the location where you want to store the number.

- For an upper memory location, press a memory number button.

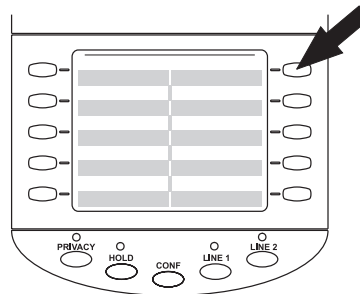

- For a lower memory location, press **LOWER**, then a memory number button.

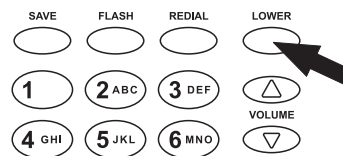

Each time you finish storing or erasing a number in memory, the speakerphone beeps to confirm the entry.

Repeat these steps for each number you want to store.

Notes:

- To change a number in memory, store a new one in its place.
- To erase a number from memory, repeat all except Step 2, selecting the location you want to erase in Step 4.

Storing a Pause in Memory

In some telephone systems, you must dial an access code (9, for example) and wait for a second dial tone before you can dial an outside number. You can store the access code with the phone number. However, you should also store a pause after the access code to allow the outside line time to connect.

To add one or more 2-second pauses to a phone number you are storing in memory, press **REDIAL** at each point where a pause is needed.

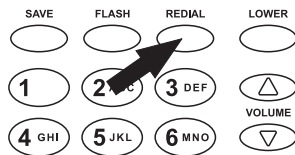

Note: Each pause entry counts as one memory digit in the stored number.

Dialing a Stored Number

To dial a number stored in memory, lift the handset or press **HEADSET/SPEAKER**, then:

- To dial a number stored in upper memory, press the desired memory location number.
- To dial a number stored in lower memory, press **LOWER** then the desired memory location number.

Note: If you select a memory location number that does not have a phone number stored in it, press **HEADSET/SPEAKER** again then press the correct memory location number.

Chain Dialing Service Numbers

You can make a call using more than one of the two-line speakerphone's memory locations. This is called chain dialing. Chain dialing is useful for dialing special services such as alternate long distance or bank-by-phone.

Testing Stored Emergency Numbers

If you store an emergency service's number (police and fire departments, ambulance) and you want to test the stored number, make the test call during the late evening or early morning hours to avoid peak demand periods. Also, remain on the line to explain the reason for your call.

Using the Phone Number Index Card

Slide the phone's name and number index card and plastic cover out of its slot and remove it. Use the phone number index card on the base to keep track of numbers stored in the memory locations or to record important phone numbers.

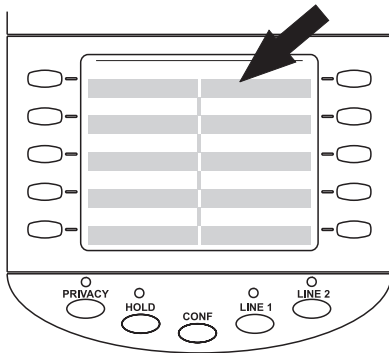

2. Place the headset on your head with the earpiece over either ear and adjust the microphone boom until it is about even with your chin.

3. Press **HEADSET** to make or receive calls.

When you finish the conversation, press **HEADSET** to hang up

Note: The headset does not operate during a power failure.

CONNECTING AN OPTIONAL HEADSET

Your ET-469 is equipped with a headset jack on the base. This jack allows you to connect an optional headset (such as RadioShack Cat. No. 43-195) so you can step away from the phone within the headset cord's length — perfect for when you are moving around in the office or kitchen.

Follow these steps to use a headset:

1. Insert the headset's $\frac{3}{32}$ -inch (2.5 mm) plug into the Ω jack on the right side of the base.

TROUBLESHOOTING

We do not expect you to have any problems with your phone, but if you do, these suggestions might help.

Problem:	Suggestion:
Low volume or unusual sounds.	Someone has picked up another phone on the same line. Hang up the other phone.
Phone does not work or works poorly.	Check that the appropriate LINE button is pressed.
	Check the T/P (Tone/Pulse) setting.
	Check the phone line connection.
	Check the AC adapter connection.
The call is too noisy (static or interference).	Hang up and redial the number.
Both red line indicators are lit, but there is no dial tone on either line.	Check that the modular cord is properly connected at both ends.
The phone's line status indicators do not light.	Adjust the line status indicators.

If you still have problems, disconnect the phone. If other phones on the same line(s) work properly, the fault is in this phone or its installation. If you cannot locate the problem, take your phone to your local RadioShack store for assistance.

CARE AND MAINTENANCE

Your RadioShack ET-469 Two-Line Speakerphone is an example of superior design and craftsmanship. The following suggestions will help you care for your ET-469 so you can enjoy it for years.



Keep the ET-469 dry. If it gets wet, wipe it dry immediately. Liquids might contain minerals that can corrode the electronic circuits.



Use and store the ET-469 only in normal temperature environments. Temperature extremes can shorten the life of electronic devices and distort or melt plastic parts.



Keep the ET-469 away from dust and dirt, which can cause premature wear of parts.



Handle the ET-469 gently and carefully. Dropping it can damage circuit boards and cases and can cause the ET-469 to work improperly.



Wipe the ET-469 with a damp cloth occasionally to keep it looking new. Do not use harsh chemicals, cleaning solvents, or strong detergents to clean the ET-469.

Modifying or tampering with the ET-469's internal components can cause a malfunction and might invalidate its warranty and void your FCC authorization to operate it. If your ET-469 is not performing as it should, take it to your local RadioShack store for assistance. If the trouble is affecting the telephone lines, the phone company can ask you to disconnect your ET-469 until you have resolved the problem.



THE FCC WANTS YOU TO KNOW

In the unlikely event that your phone causes problems on the phone line, the phone company can temporarily discontinue your service. If this happens, the phone company attempts to notify you in advance. If advance notice is not practical, the phone company notifies you as soon as possible and advises you of your right to file a complaint with the FCC.

Also, the phone company can make changes to its lines, equipment, operations, or procedures that could affect the operation of this telephone. The telephone company notifies you of these changes in advance, so you can take the necessary steps to prevent interruption of your telephone service.

LIGHTNING

Your telephone has built-in protection circuits to reduce the risk of damage from surges in telephone line and power line current. These protection circuits meet or exceed the FCC requirements. However, lightning striking the telephone or power lines can damage your telephone.

Lightning damage is not common. Nevertheless, if you live in an area that has severe electrical storms, we suggest that you unplug your phone during storms to reduce the possibility of damage.

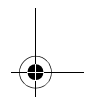
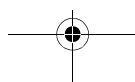
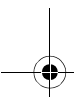
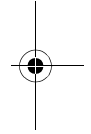
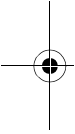

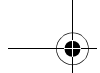

NOTES

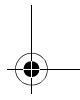
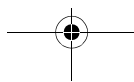
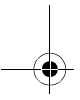
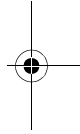
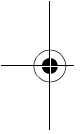

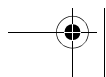
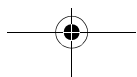
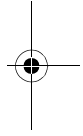
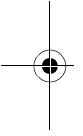
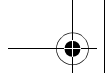

Limited One-Year Warranty

This product is warranted by RadioShack against manufacturing defects in material and workmanship under normal use for one (1) year from the date of purchase from RadioShack company-owned stores and authorized RadioShack franchisees and dealers. EXCEPT AS PROVIDED HEREIN, RadioShack MAKES NO EXPRESS WARRANTIES AND ANY IMPLIED WARRANTIES, INCLUDING THOSE OF MERCHANTABILITY AND FITNESS FOR A PARTICULAR PURPOSE, ARE LIMITED IN DURATION TO THE DURATION OF THE WRITTEN LIMITED WARRANTIES CONTAINED HEREIN. EXCEPT AS PROVIDED HEREIN, RadioShack SHALL HAVE NO LIABILITY OR RESPONSIBILITY TO CUSTOMER OR ANY OTHER PERSON OR ENTITY WITH RESPECT TO ANY LIABILITY, LOSS OR DAMAGE CAUSED DIRECTLY OR INDIRECTLY BY USE OR PERFORMANCE OF THE PRODUCT OR ARISING OUT OF ANY BREACH OF THIS WARRANTY, INCLUDING, BUT NOT LIMITED TO, ANY DAMAGES RESULTING FROM INCONVENIENCE, LOSS OF TIME, DATA, PROPERTY, REVENUE, OR PROFIT OR ANY INDIRECT, SPECIAL, INCIDENTAL, OR CONSEQUENTIAL DAMAGES, EVEN IF RadioShack HAS BEEN ADVISED OF THE POSSIBILITY OF SUCH DAMAGES.

Some states do not allow the limitations on how long an implied warranty lasts or the exclusion of incidental or consequential damages, so the above limitations or exclusions may not apply to you.

In the event of a product defect during the warranty period, take the product and the RadioShack sales receipt as proof of purchase date to any RadioShack store. RadioShack will, at its option, unless otherwise provided by law: (a) correct the defect by product repair without charge for parts and labor; (b) replace the product with one of the same or similar design; or (c) refund the purchase price. All replaced parts and products, and products on which a refund is made, become the property of RadioShack. New or reconditioned parts and products may be used in the performance of warranty service. Repaired or replaced parts and products are warranted for the remainder of the original warranty period. You will be charged for repair or replacement of the product made after the expiration of the warranty period.

This warranty does not cover: (a) damage or failure caused by or attributable to acts of God, abuse, accident, misuse, improper or abnormal usage, failure to follow instructions, improper installation or maintenance, alteration, lightning or other incidence of excess voltage or current; (b) any repairs other than those provided by a RadioShack Authorized Service Facility; (c) consumables such as fuses or batteries; (d) cosmetic damage; (e) transportation, shipping or insurance costs; or (f) costs of product removal, installation, set-up service adjustment or reinstallation.

This warranty gives you specific legal rights, and you may also have other rights which vary from state to state.

RadioShack Customer Relations, Dept. W, 100 Throckmorton St., Suite 600, Fort Worth, TX 76102

We Service What We Sell

3/97

RadioShack
A Division of Tandy Corporation
Fort Worth, Texas 76102

01A99

Printed in China