

Model 28213 Series DECT 6.0 Multi-Handset Speakerphone User's Guide



Your new GE telephone system is **EXPANDABLE**
up to a total of 6 handsets (by purchase of optional
Model 28203 handset with charge cradle)

Equipment Approval Information

Your telephone equipment is approved for connection to the Public Switched Telephone Network and is in compliance with parts 15 and 68, FCC Rules and Regulations and the Technical Requirements for Telephone Terminal Equipment published by ACTA.

1 Notification to the Local Telephone Company

On the bottom of this equipment is a label indicating, among other information, the US number and Ringer Equivalence Number (REN) for the equipment. You must, upon request, provide this information to your telephone company.

The REN is useful in determining the number of devices you may connect to your telephone line and still have all of these devices ring when your telephone number is called. In most (but not all) areas, the sum of the RENs of all devices connected to one line should not exceed 5. To be certain of the number of devices you may connect to your line as determined by the REN, you should contact your local telephone company.

A plug and jack used to connect this equipment to the premises wiring and telephone network must comply with the applicable FCC Part 68 rules and requirements adopted by the ACTA. A compliant telephone cord and modular plug is provided with this product. It is designed to be connected to a compatible modular jack that is also compliant. See installation instructions for details.

Notes

- This equipment may not be used on coin service provided by the telephone company.
- Party lines are subject to state tariffs, and therefore, you may not be able to use your own telephone equipment if you are on a party line. Check with your local telephone company.
- Notice must be given to the telephone company upon permanent disconnection of your telephone from your line.
- If your home has specially wired alarm equipment connected to the telephone line, ensure the installation of this product does not disable your alarm equipment. If you have questions about what will disable alarm equipment, consult your telephone company or a qualified installer.

US Number is located on the cabinet bottom.

REN Number is located on the cabinet bottom.

2 Rights of the Telephone Company

Should your equipment cause trouble on your line which may harm the telephone network, the telephone company shall, where practicable, notify you that temporary discontinuance of service may be required. Where prior notice is not practicable and the circumstances warrant such action, the telephone company may temporarily discontinue service immediately. In case of such temporary discontinuance, the telephone company must: (1) promptly notify you of such temporary discontinuance; (2) afford you the opportunity to correct the situation; and (3) inform you of your right to bring a complaint to the Commission pursuant to procedures set forth in Subpart E of Part 68, FCC Rules and Regulations.

The telephone company may make changes in its communications facilities, equipment, operations or procedures where such action is required in the operation of its business and not inconsistent with FCC Rules and Regulations. If these changes are expected to affect the use or performance of your telephone equipment, the telephone company must give you adequate notice, in writing, to allow you to maintain uninterrupted service.

Interference Information

This device complies with Part 15 of the FCC Rules. Operation is subject to the following two conditions: (1) This device may not cause harmful interference; and (2) This device must accept any interference received, including interference that may cause undesired operation.

This equipment has been tested and found to comply with the limits for a Class B digital device, pursuant to Part 15 of the FCC Rules. These limits are designed to provide reasonable protection against harmful interference in a residential installation.

This equipment generates, uses, and can radiate radio frequency energy and, if not installed and used in accordance with the instructions, may cause harmful interference to radio communications. However, there is no guarantee that interference will not occur in a particular installation.

Privacy of Communications may not be ensured when using this product.

If this equipment does cause harmful interference to radio or television reception, which can be determined by turning the equipment off and on, the user is encouraged to try to correct the interference by one or more of the following measures:

- Reorient or relocate the receiving antenna (that is, the antenna for radio or television that is "receiving" the interference).
- Reorient or relocate and increase the separation between the telecommunications equipment and receiving antenna.
- Connect the telecommunications equipment into an outlet on a circuit different from that to which the receiving antenna is connected.

If these measures do not eliminate the interference, please consult your dealer or an experienced radio/television technician for additional suggestions. Also, the Federal

Communications Commission has prepared a helpful booklet, "How To Identify and Resolve Radio/TV Interference Problems." This booklet is available from the U.S. Government Printing Office, Washington, D.C. 20402. Please specify stock number 004-000-00345-4 when ordering copies.

Notice: The changes or modifications not expressly approved by the party responsible for compliance could void the user's authority to operate the equipment.

Hearing Aid Compatibility (HAC)

This telephone system meets FCC standards for Hearing Aid Compatibility.

Licensing

Licensed under US Patent 6,427,009.

FCC RF Radiation Exposure Statement

This equipment complies with FCC RF radiation exposure limits set forth for an uncontrolled environment. This equipment should be installed and operated with a minimum distance of 20 centimeters between the radiator and your body. This transmitter must not be co-located or operated in conjunction with any other antenna or transmitter.

For body worn operation, this phone has been tested and meets the FCC RF exposure guidelines when used with the belt clip supplied with this product. Use of other accessories may not ensure compliance with FCC RF exposure guidelines.

Information for DECT Product



This telephone is compliant with the DECT 6.0 standard which operates in the 1.92GHz to 1.93GHz frequency range. Installation of this equipment is subject to notification and coordination with UTAM. Any relocation of this equipment must be coordinated through and approved by UTAM. UTAM may be contacted at 1-800-429-8826.



Table of Contents

EQUIPMENT APPROVAL INFORMATION ...	2	LANGUAGE.....	17
INTERFERENCE INFORMATION.....	3	AUTO TALK.....	18
HEARING AID COMPATIBILITY (HAC) ...	4	REGISTRATION.....	18
LICENSING	4	DE-REGISTRATION.....	19
FCC RF RADIATION EXPOSURE		GLOBAL DE-REGISTRATION.....	20
STATEMENT.....	4	SOUND SETUP.....	20
INFORMATION FOR DECT PRODUCT ...	4	RINGER TONE.....	20
INTRODUCTION	7	RINGER VOLUME.....	21
BEFORE YOU BEGIN	7	KEY TONE.....	21
PARTS CHECKLIST.....	7	RESET SETTING.....	21
TELEPHONE JACK REQUIREMENTS.....	8	VOICEMAIL.....	22
INSTALLATION	8	ALL SETTINGS.....	22
DIGITAL SECURITY SYSTEM.....	8	TELEPHONE OPERATION	22
IMPORTANT INSTALLATION		VISUAL INDICATORS	22
GUIDELINES.....	9	BASE.....	22
BASE LAYOUT	10	HANDSET.....	23
FRONT VIEW.....	10	VMWI / VISUAL RINGER INDICATOR ON	
HANDSET LAYOUT	11	HANDSET.....	23
DISPLAY ICONS.....	11	SPEAKERPHONE OPERATION ...	23
INSTALLING THE PHONE.....	12	MAKING A CALL.....	23
INSTALLING THE HANDSET BATTERY	12	ANSWERING CALLS.....	24
BASE STATION	13	CALL TIMER.....	24
PROGRAMMING THE TELEPHONE	14	AUTO STANDBY.....	24
STANDBY SCREEN.....	14	RINGER VOLUME.....	24
PROGRAMMING FUNCTIONS.....	14	FLASH/CALL WAITING.....	25
ROOM MONITOR.....	14	LAST NUMBER REDIAL.....	25
ALARM CLOCK.....	15	EXIT.....	25
INITIAL SETUP.....	16	PAGE.....	26
HANDSET NAME.....	16	PAGING FROM THE BASE/GROUP	
DATE AND TIME.....	16	PAGE.....	26
AREA CODE.....	17	MUTE.....	26
TONE/PULSE.....	17	RECEIVER VOLUME CONTROL.....	26

Table of Contents

DO NOT DISTURB (D-N-D)	26	DELETING A CID RECORD	33
GOOG411	27	DELETING ALL CID RECORDS	33
INTERCOM OPERATION	28	PHONEBOOK	34
MAKING AN AUTO INTERCOM		REVIEW RECORDS.....	34
CALL.....	28	ADD RECORDS.....	34
ADVANCED INTERCOM FEATURES.....	29	INSERTING A PAUSE IN THE DIALING	
RECEIVING AN INCOMING CALL		SEQUENCE.....	35
DURING AN INTERCOM		EDIT RECORDS.....	35
CALL	29	DELETE RECORDS.....	35
USING INTERCOM WITH EXTERNAL		DIALING A NUMBER FROM INTERNAL	
TELEPHONE CALLS	29	MEMORY	36
TWO-WAY CALLING.....	29	CHANGING THE BATTERY	37
THREE-WAY CALLING	29	BATTERY SAFETY PRECAUTIONS.....	37
TRANSFERRING EXTERNAL CALLS TO		DISPLAY MESSAGES	38
OTHER HANDSETS	30	TROUBLESHOOTING GUIDE	39
CALLER ID (CID)	30	CAUSES OF POOR RECEPTION	41
CALL WAITING CALLER ID	31	GENERAL PRODUCT CARE	42
RECEIVING CID RECORDS.....	31	WARRANTY ASSISTANCE	42
STORING CID RECORDS.....	31	LIMITED WARRANTY	43
REVIEWING CID RECORDS.....	31	ACCESSORY INFORMATION	45
DIALING A CID NUMBER.....	32	INDEX	46
STORING CID RECORDS IN INTERNAL			
MEMORY	32		

WARNING: TO PREVENT FIRE OR ELECTRICAL SHOCK HAZARD, DO NOT EXPOSE THIS PRODUCT TO RAIN OR MOISTURE.

	<p>CAUTION: RISK OF ELECTRIC SHOCK DO NOT OPEN</p>	
<p>THE LIGHTNING FLASH AND ARROW HEAD WITHIN THE TRIANGLE IS A WARNING SIGN ALERTING YOU OF "DANGEROUS VOLTAGE" INSIDE THE PRODUCT.</p>	<p>CAUTION: TO REDUCE THE RISK OF ELECTRIC SHOCK, DO NOT REMOVE COVER (OR BACK). NO USER SERVICEABLE PARTS INSIDE. REFER SERVICING TO QUALIFIED SERVICE PERSONNEL.</p>	<p>THE EXCLAMATION POINT WITHIN THE TRIANGLE IS A WARNING SIGN ALERTING YOU OF IMPORTANT INSTRUCTIONS ACCOMPANYING THE PRODUCT.</p>
<p>SEE MARKING ON BOTTOM / BACK OF PRODUCT</p>		

Introduction



CAUTION: When using telephone equipment, there are basic safety instructions that should always be followed. Refer to the **IMPORTANT SAFETY INSTRUCTIONS** provided with this product and save them for future reference.

IMPORTANT: Because cordless phones operate on electricity, you should have at least one phone in your home that isn't cordless, in case the power in your home goes out.

Before You Begin

Parts Checklist (for 28213 model)

Make sure your package includes the items shown here.

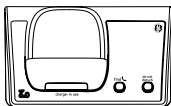

Base



Battery
compartment
cover



AC power
adaptor



Telephone line cord



Belt Clip



Handset
battery pack



Handset

Note: If a speaker box is included in your package, it replaces one set of a handset, belt clip, battery pack and cover.

For **Model 28213xx2** there will be **ONE** additional handset, charge cradle, belt clip, battery pack and cover than shown above.

For **Model 28213xx3** there will be **TWO** additional handsets, charge cradles, belt clips, battery packs and covers than shown above.

For **Model 28213xx4** there will be **THREE** additional handsets, charge cradles, belt clips, battery packs and covers than shown above.

For **Model 28213xx5** there will be **FOUR** additional handsets, charge cradles, belt clips, battery packs and covers than shown above.

For **Model 28213xx6** there will be **FIVE** additional handsets, charge cradles, belt clips, battery packs and covers than shown above.

Telephone Jack Requirements

To use this phone, you need an RJ11C type modular telephone jack, which might look like the one pictured here, installed in your home. If you don't have a modular jack, call your local phone company to find out how to get one installed.

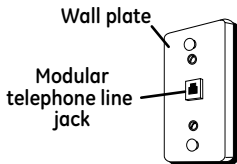

Installation

Digital Security System

Your cordless phone uses a digital security system to protect against false ringing, unauthorized access, and charges to your phone line.

INSTALLATION NOTE: Some cordless telephones operate at frequencies that may cause or receive interference with nearby TVs, microwave ovens, and VCRs. To minimize or prevent such interference, the base of the cordless telephone should not be placed near or on top of a TV, microwave ovens, or VCR. If such interference continues, move the cordless telephone farther away from these appliances.

Certain other communications devices may also use the 1.9GHz DECT frequency for communication, and, if not properly set, these devices may interfere with each other and/or your new telephone. If you are concerned with interference, please refer to the owner's manual for these devices on how to properly set channels to avoid interference. Typical devices that may use the 1.9GHz DECT frequency for communication include wireless audio/video senders, wireless computer networks, multi-handset cordless telephone systems, and some long-range cordless telephone systems.

Important Installation Guidelines

- Avoid sources of noise and heat, such as motors, fluorescent lighting, microwave ovens, heating appliances and direct sunlight.
- Avoid areas of excessive dust, moisture and low temperature.
- Avoid other cordless telephones or personal computers.
- Never install telephone wiring during a lightning storm.
- Never install telephone jacks in wet locations unless the jack is specifically designed for wet locations.
- Never touch non-insulated telephone wires or terminals, unless the telephone line has been disconnected at the network interface.
- Use caution when installing or modifying telephone lines.

Base Layout

Front View

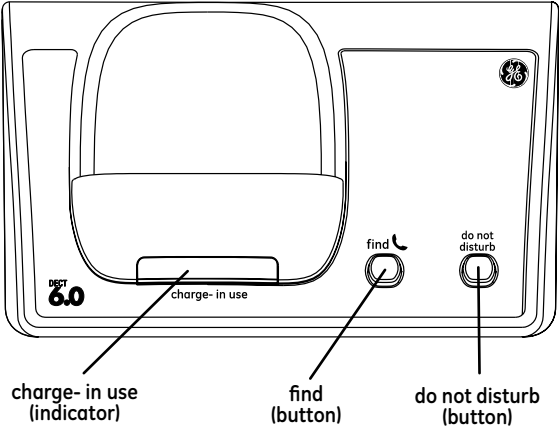

Handset Layout

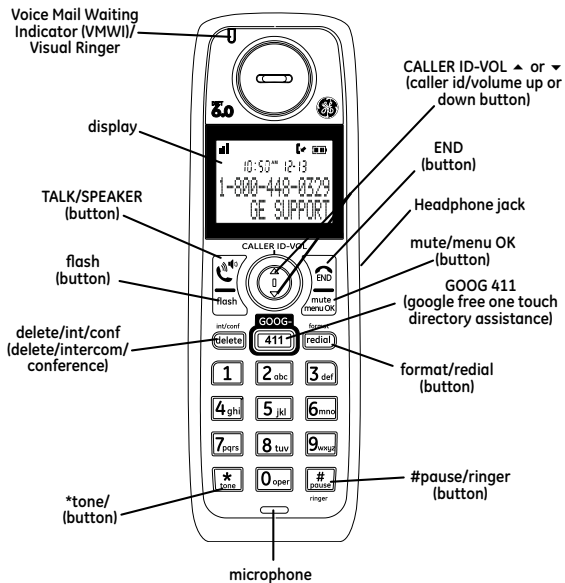

Display Icons

	Signal strength		Alarm ON
	Speakerphone		New Call
	Message		Battery
	Voicemail	AM	AM
	SMS	PM	PM
	Ringer OFF/DND ON		

Installing the Phone

Installing the Handset Battery

NOTE: You must connect the handset battery before use.



CAUTION: To reduce the risk of fire or personal injury, use only the Thomson Inc. approved Nickel-metal Hydride battery (Ni-MH) battery model 5-2840, that is compatible with this unit.

1. Locate battery and battery door which are packaged together inside a plastic bag and are separate from the handset.
2. Locate the battery compartment on the back of the handset.
3. Plug the battery pack cord into the jack inside the compartment.

NOTE: To ensure proper battery installation, the connector is keyed and can be inserted only one way.

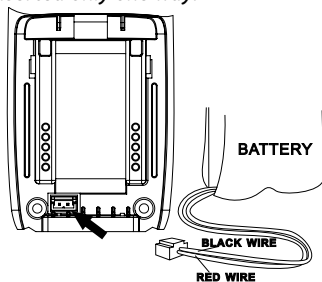

4. Insert the battery pack.
5. Close the battery compartment by pushing the door up until it snaps into place.

Base Station

1. Choose an area near an electrical outlet and a telephone wall jack (RJ11C), and place your cordless telephone on a level surface, such as a desktop or tabletop, or you may mount it on the wall.

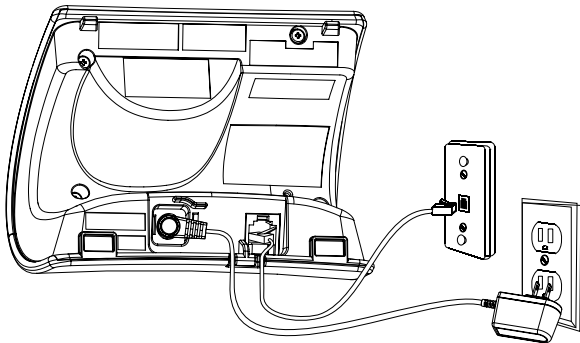

2. Plug one end of the telephone line cord into the TEL LINE jack on the back of the base and the other end into a modular jack.
3. Plug the AC power converter into the electrical outlet and the DC connector into the jack on the back of the base.
4. Place the handset in the base cradle. The charge/in use indicator turns on, verifying the battery is charging.
5. Allow the phone to charge for 16 hours prior to first use. If you don't properly charge the phone, battery performance is compromised.



CAUTION: To reduce risk of personal injury, fire, or damage use only the 5-2812 power adaptor listed in the user's guide. This power adaptor is intended to be correctly orientated in a vertical or floor mount position.

Programming the Telephone

Standby Screen

The handset displays the handset number and user name.

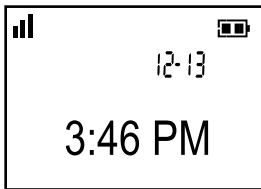

Programming Functions

The system uses a menu structure to give you access to all of the built-in features. You may program the following items in main menu: Phone book, Room Monitor, Alarm Clock, Initial Setup, Sound Setup, Reset Settings.

Room Monitor (applicable only with additional handsets)

1. Make sure your phone is **OFF** (not in TALK mode).
2. Press the **mute/menu OK** button to go to the main menu.
3. Press **caller ID-volume** (▼ or ▲) button to scroll to **ROOM MONITOR**.
4. Press the **mute/menu OK** button to enter **ROOM MONITOR** menu. The screen displays **ROOM MONITOR EXTENSION?**

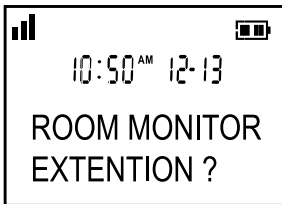

5. Use the touch tone pad to enter the handset name/number to be monitored.
NOTE: When this phone system is expanded (up to 6 handsets by purchase of optional Model 28203 handset with recharge cradle), handsets are named HANDSET 1, HANDSET 2, HANDSET 3 and so on respectively.
6. The receiving handset will turn on the microphone and the originating handset will turn on the speakerphone to monitor sound from the receiving handset.
NOTE: For room monitoring mode to work, the originating handset must NOT be on the cradle.
NOTE: While in room monitoring mode, the handsets will emit an alert tone approximately every 5 seconds if there is an incoming call. You may press the TALK/SPEAKER button to quit room monitor and answer the call.
NOTE: While in room monitoring mode, the originating handset can be switched to monitor by handset earpiece by pressing the TALK/SPEAKER button once. Switch back to speakerphone by pressing the TALK/SPEAKER button once.
NOTE: Press the END button on the handset to exit room monitor mode.

Alarm Clock

1. Make sure your phone is **OFF** (not in TALK mode)
2. Press the **mute/menu OK** button to go to the main menu.
3. Use the **caller ID-volume** (▲ or ▼) button to scroll to **ALARM CLOCK**.
4. Press **mute/menu OK** button to enter the menu. The screen displays **ON > OFF**.
5. Use the **caller ID-volume** (▲ or ▼) button to select **ON** or **OFF**. Press **mute/menu OK** button to confirm.
6. If **ON** is selected, then the screen displays **SET ALARM TIME**. Use the number keys to enter the alarm time (for example, 02:10PM) key in 0210. Use the **caller ID-volume** (▲ or ▼) button to select **AM** or **PM**.
7. Press **mute/menu OK** button to display **>ONCE OR DAILY** and select **ONCE** or **DAILY**.
8. Press the **mute/menu ok** button to save selection. You will hear a confirmation tone and return to main menu.

Initial Setup

1. Make sure your phone is **OFF** (not in TALK mode).
2. Press the **mute/menu OK** button to go to the main menu.
3. Press **caller ID-volume** (▼ or ▲) button to scroll to **INITIAL SETUP**.
4. Press the **mute/menu OK** button to confirm and you may program the following items: Handset Name, Date and Time, Area Code, Tone/Pulse, Language, Auto Talk, Registration, Deregistration.

NOTE: During programming, you may press the END button at any time to exit the sub-menu and return to the menu.

Handset Name

From the Initial Setup Menu:

1. Press the **caller ID-volume** (▲ or ▼) button to scroll to the **HANDSET NAME** sub-menu.
2. Press **mute/menu OK** button to enter the menu. The screen displays **HANDSET NAME**.
3. Use the touch-tone pad to enter a name (up to 15 characters). More than one letter is stored in each of the number keys. For example, to enter Bill Smith, press the key twice for the letter B. Press the key times for the letter I. Press the 5 key times for the letter L. Press the 5 key times for the second letter L, and press the 1 key to insert a space between the first and last name. Press the 7 key times for the letter S; press the 6 key once for the letter M; press the key times for the letter I; press the 8 key for the letter T; press the key twice for the letter H.

NOTE: If you make a mistake, use the delete/int/conf button to backspace and delete one character at a time.

4. Press the **mute/menu OK** button to save your name. You will hear a confirmation tone and the handset name shows in the display.

Date and Time

From the Initial Setup Menu:

1. Press the **caller ID-volume** (▲ or ▼) button to scroll to the **DATE and TIME** sub-menu.
2. Press **mute/menu OK** button to enter the menu. Use the number keys to enter the current date, (for example, 31 December, 2007) key in 071231.
3. Press **mute/menu OK** button to confirm your selection and advance **SET TIME** sub-menu.

4. Use the number keys to enter the current hour and minute, then use the **caller ID-volume** (▲ or ▼) to select **AM** or **PM**.
5. Press the **mute/menu OK** button to save your selection. You will hear a confirmation tone and the current time shows in the display.

Area Code

From the Initial Setup Menu:

1. Press the **caller ID-volume** (▲ or ▼) button to scroll to the **AREA CODE** sub-menu.
2. Press **mute/menu OK** button to enter the menu. The screen displays **SET AREA CODE - - -**.
3. Use the touch-tone pad to enter your 3-digit area code.
4. Press the **mute/menu OK** button to confirm. You will hear a confirmation tone and the new area code shows in the display.

NOTE: To restore the default setting to - - -, press and release delete/int/conf when SET AREA CODE shows in the display.

Tone/Pulse

From the Initial Setup Menu:

1. Press the **caller ID-volume** (▲ or ▼) button to scroll to the **TONE/PULSE** sub-menu.
2. Press **mute/menu OK** button to enter the menu. The screen displays ▶ **TONE PULSE**. The default setting is **TONE**.
3. Use the **caller ID-volume** (▲ or ▼) to select **TONE** or **PULSE**.
4. Press the **mute/menu OK** button to confirm. You will hear a confirmation tone and your selection shows in the display.

Language

From the Initial Setup Menu:

1. Press the **caller ID-volume** (▲ or ▼) button to scroll to the **LANGUAGE** sub-menu.
2. Press **mute/menu OK** button to enter the menu. The screen displays ▶ **ENGLISH ESPANOL**.
3. Use the **caller ID-volume** (▲ or ▼) button to scroll to the desired language. **ENGLISH** is the default setting.
4. Press the **mute/menu OK** button to save your selection. You will hear a confirmation tone and the selected language shows in the display.

Auto Talk

When this function is **ON**, during an external call, you may lift the handset to answer a call immediately without pressing any buttons. To end a call, put the handset back on the base cradle directly.

From the Initial Setup Menu:

1. Press the **caller ID-volume** (▲ or ▼) button to scroll to the **AUTO TALK** sub-menu.
2. Press **mute/menu OK** button to enter the menu. The screen displays **> NO YES**.
3. Use the **caller ID-volume** (▲ or ▼) button to scroll to your selection. **NO** is the default setting.
4. Press the **mute/menu OK** button to confirm.

Registration

Your packaged handset(s) are pre-registered and ready to use. It is not recommended that a handset be registered again unless absolutely necessary.

From the Initial Setup Menu:

1. Press the **caller ID-volume** (▲ or ▼) button to scroll to the **REGISTRATION** sub-menu.
2. Press the **mute/menu OK** button to enter the menu. The screen displays **YES ▶ NO**. The default setting is **NO**.
3. Use the **caller ID-volume** (▲ or ▼) button to scroll to **YES** or **NO**.
4. If you select **YES**, press the **mute/menu OK** button. The screen displays **HOLD BASE FIND FOR 5 SECONDS, THEN PRESS MENU OK KEY**. (Your handset should be held near the base during registration process.)
5. Press and hold the **find** button on the base unit, the charge/in use indicator flashes. Press the handset **mute/menu OK** button. The screen displays **REGISTERING**. The handset screen displays **REGISTERED**. You may now rename your handset. (Refer to Step & of Handset Name Section)

NOTE: If you are re-registering the handset through the handset menu; to rename your handset you must go to the Handset Name Section and start from the beginning step.

De-Registration

De-registration cancels registration. During the de-registration process, keep the handset near the base.

From the Initial Setup Menu:

1. Press the **caller ID-volume** (▲ or ▼) button to scroll to the **DEREGISTRATION** sub-menu.
2. Press the **mute/menu OK** button to enter the menu. The screen displays **YES ▶ NO**. The default setting is **NO**.
3. Use the **caller ID-volume** (▲ or ▼) button to scroll to **YES** or **NO**.



WARNING: It is not recommended that a handset be de-registered unless absolutely necessary because once a handset is de-registered, that handset's telephone features cannot be used until the handset is re-registered.

4. Select **NO**, if you do not want to de-register.
5. If you select **YES**, press the **mute/menu OK** button and **MOVE NEAR BASE** displays for seconds, then the screen displays **YES NO**.
6. Use the **caller ID-volume** (▲ or ▼) button to scroll to **YES** or **NO**.
7. If you select **YES**, press the **mute/menu OK** button to confirm. The screen displays **DE-REGISTER....** You will hear a confirmation tone. Then the screen displays **DEREGISTERED** to confirm the handset is deregistered.

NOTE: When you complete the de-registration process, the screen displays **HANDSET NEEDS REGISTRATION. To use the handset, you **MUST** re-register the handset using the Registration process.**

Global De-registration

If one or more handsets become lost, you should de-register all handsets to ensure proper system operation.



WARNING: It is not recommended that a handset be de-registered unless absolutely necessary because once a handset is de-registered, that handset's telephone features cannot be used until the handset is re-registered.

1. Disconnect power from the base by pulling the plug out of the back of the unit.
2. Press and hold the **find** button and while holding the **find** button reconnect the power.
3. Continue to hold the **find** button until the charge/in use light flashes rapidly.
4. Release the **find** button.
5. Press and release the **find** button on the base once. All handsets are de-registered and the screen displays **HANDSET NEEDS REGISTRATION**.

Sound Setup

1. Make sure your phone is **OFF** (not in TALK mode).
2. Press the **mute/menu OK** button to go to the main menu.
3. Press **caller ID-volume** (▲ or ▼) button to scroll to **SOUND SETUP**.
4. Press **mute/menu OK** button to confirm and you may program the following items: Ringer Tone, Ringer Volume, Key Tone.

Ringer Tone

You may choose from five different ringer tones and five different melodies.

From the Sound Setup Menu:

1. Press the **caller ID-volume** (▲ or ▼) button to scroll to the **RINGER TONE** sub-menu.
2. Press **mute/menu OK** button to enter the menu. The screen displays ▶ **1 OF 10**. 01 is default setting.
3. Use the **caller ID-volume** (▲ or ▼) button to scroll to the desired setting (1 through 10). You will hear a sample of the ringer tone/melody you select.
4. Press the **mute/menu OK** button to save your selection. You will hear a confirmation tone and the selected ringer tone shows in the display.

NOTE: You must have the Ringer Volume set to ON for ring tone to signal an incoming call.

Ringer Volume

From the Sound Setup Menu:

1. Press the **caller ID-volume** (▲ or ▼) button to scroll to the **RINGER VOLUME** sub-menu.
2. Press **mute/menu OK** button to enter the menu. The screen displays ▶ **RING VOLUME 5**.
3. Use the **caller ID-volume** (▲ or ▼) button to scroll to your selection. *LEVEL 5* is the default setting.
4. Press the **mute/menu OK** button to save your selection. You will hear a confirmation tone and the new volume setting shows in the display.

NOTE: If you turn the ringer OFF, the ringer off icon shows in the display.

Key Tone

From the Sound Setup Menu:

1. Press the **caller ID-volume** (▲ or ▼) button to scroll to the **KEY TONE** sub-menu.
2. Press **mute/menu OK** button to enter the menu. The screen displays > **ON OFF**.
3. Use **caller ID-volume** (▲ or ▼) button to scroll to your selection. *ON* is the default setting.
4. Press the **mute/menu OK** button to confirm and the key tone setting shows in the display.

Reset Setting

1. Make sure your phone is **OFF** (not in TALK mode).
2. Press the **mute/menu OK** button to go to the main menu.
3. Press **caller ID-volume** (▲ or ▼) button to scroll to **RESET SETTINGS**.
4. Press **mute/menu OK** button to confirm and you may program the following items: Voicemail, All Settings.

VoiceMail

From the Reset Settings Menu:

1. Press the **caller ID-volume** (▲ or ▼) button to scroll to the **VOICEMAIL** sub-menu.
2. Press the **mute/menu OK** button to enter the menu. The screen displays ► **YES NO**. The default setting is **NO**.
3. Use the **caller ID-volume** (▲ or ▼) button to move the cursor to **YES** or **NO**.
NOTE: If YES is selected, new voicemail icon is cleared from the LCD and the VMWI LED is turned OFF (on ALL handsets, and the charge/in use LED on the base).
4. Press the **mute/menu OK** button to save your selection. You will hear a confirmation tone.

All Settings

As you become familiar with this system, you may prefer to use the system's original settings. Follow the steps below to return to the factory default settings.

From the Reset Settings Menu:

1. Press the **caller ID-volume** (▲ or ▼) button to scroll to the **ALL SETTINGS** sub-menu.
2. Press the **mute/menu OK** button to enter the menu. The screen displays **YES ► NO**. The default setting is **NO**.
3. Use the **caller ID-volume** (▲ or ▼) button to move the cursor to **YES** or **NO**.
NOTE: If you choose YES all the settings in the programmable menu are returned to factory default setting.
4. Press the **mute/menu OK** button to save your selection. You will hear a confirmation tone.

Telephone Operation

Visual Indicators

Base

The charge/in use indicator on the base will flash to alert you to an incoming call, during paging, or if you have a message waiting from your service provider. The indicator will remain lit when a handset is in the base charging or when the line is in use.

Handset

The **TALK/SPEAKER** indicator buttons flash when you receive a call and remain lit during a call.

The keypad and CID will also light when a call is received.

VMWI / Visual Ringer Indicator on Handset

IMPORTANT: In order to use this unit's Voice Mail Waiting Indicator (VMWI) feature, you must subscribe to this service from your phone company.

The VMWI indicator on the top of the handset flashes when you receive a new message from your service provider. Also, it serves as a Visual Ringer function. It will flash when there is an incoming call.

Speakerphone Operation

NOTE: If you are using the speakerphone, remain close to handset so the party you are speaking to can hear you.

If you are using the earpiece and want to switch to the speakerphone, press the **TALK/SPEAKER** button, press **END** button to end conversation.

If you are using the speakerphone and want to switch to the earpiece, press the **TALK/SPEAKER** button again, press **END** button again to end conversation.

Making a Call

1. Press the **TALK/SPEAKER** button. Dial the desired number.

- OR -

Dial the number first, then press the **TALK/SPEAKER** button.

- OR -

Press the **caller ID-volume** (▲ or ▼) button to select the desired record, then press the **TALK/SPEAKER** button.

2. When finished, press the **END** button to hang up.

NOTE: You may enter up to 28 pre-dial digits.

NOTE: If you want to delete the pre-dial number you entered, press the delete/int/conf button until all of the digits are erased.

Answering Calls

1. When the phone rings, pick up the handset and press the **TALK/SPEAKER** button.
2. When finished, press **END** button to hang up.

- OR -

If the auto talk mode is selected, pick up the handset from the charge cradle to answer the call immediately.

NOTE: Adjust the handset volume by pressing the caller ID-volume (▲ or ▼) button during a call.

Call Timer

After you press the **TALK/SPEAKER** button on the handset, the built-in call timer shows on the display and counts the length of time of the call in minutes and seconds.

Auto Standby

If you place the handset in the cradle while the handset is off the hook (during a call), the call is automatically disconnected.

Ringer Volume (Shortcut)

There are two ways to set the ringer volume. One is the traditional way as described in the Programming Functions; Sound Setup; Ringer Volume menus. The other one is this short cut to ringer menu.

1. Make sure the phone is **OFF** (not in TALK mode).
2. Press the **#pause/ringer** button to display **SET RINGER LEVEL 5**.
3. Use the **caller ID-volume** (▲ or ▼) button to scroll to your selection. **LEVEL 5** is the default setting.
4. Press **#pause/ringer** button again to save and display the new selection for a few seconds.

Flash/Call Waiting

If you subscribe to the combined Call Waiting Caller ID service from your local telephone company, you will receive Caller ID information (if available) on Call Waiting calls. During a phone call, you will hear a beep to indicate another call is waiting on the line and Caller ID information for the waiting call shows on the handset display.

- To connect to the waiting call, press the **flash** button on the handset, and your original call is put on hold.
- To switch between the two calls, press the **flash** button.

Last Number Redial

You may redial a number up to 20 digits long. To quickly redial the last number you dialed:

1. Press the **TALK/SPEAKER** button.
2. Press the **redial/format** button.
-OR-
3. Press the **redial/format** button first, then use the **caller ID-volume** (**▲** or **▼**) button to select the desired redial number.
 - Press the **caller ID-volume** (**▲**) to review the oldest call and scroll toward the most recent calls (higher numbers).
 - Press the **caller ID-volume** (**▼**) to review the newest call and scroll to older calls (lower numbers).

NOTE: You may choose from the last three numbers that were dialed.
4. Press the **TALK/SPEAKER** button. The number dials automatically.

If you get a busy signal and want to keep dialing the number, press the **redial/format** button to quickly redial the number.

Exit

Press the **END** button to exit a menu function and return to the standby screen.

Page

The page feature helps you locate a misplaced handset. To send and receive pages, all handsets must be registered. If your handset is not registered, follow the instructions in the Registration section of this manual.

Paging from the Base/Group Page

Use the base-only to page all registered handsets at the same time.

1. Press the **find** button on the base. All handsets beep for two minutes, and each handset screen displays **FIND HANDSET**.
2. To cancel the page, press the **find** button on the base, or press the **TALK/SPEAKER** button or the **END** button on each handset.

Mute

To have a private, off-line conversation, use the **MUTE** feature. The party on the telephone line cannot hear you, but you can hear them.

1. Press the **mute/menu OK** button. The handset display shows **MUTE ON**.
2. Press the **mute/menu OK** button to cancel and return to your phone conversation.

Receiver Volume Control

When the handset is **ON** (in TALK mode) you may adjust the receiver volume by pressing the **caller ID-volume** (▲ or ▼) button. There are five volume levels to choose from. When the maximum or minimum volume level is reached, the phone beeps twice. VOL 1 is minimum and VOL 5 is maximum.

Do Not Disturb (D-N-D)

This feature allows you to turn off all the handset ringer(s) at once, by pressing one button at the base unit, even though the ringer volume of handset(s) has been preset.

1. In the standby mode, press the **do not disturb** button on the base.
2. The DND indicator will light and  shows in each handset display.
3. To cancel, press the **do not disturb** button again.

NOTE: You can press the do not disturb button and activate the function immediately, even when there is incoming call ringing in, or during call screening after the call is taken by the answerer.

GOOG411

GOOG-411 is Google's new 411 service. With GOOG-411, you can find local business information completely free, directly from your phone. With purchasing the GE phone, you can access 1-800-GOOG-411 service at anytime by simply pressing the **GOOG-411** button.

1. In standby mode or dialing mode, press the **GOOG-411** button, the preset GOOG-411 service number is dialed out immediately. The screen displays **"GOOG-411: Free 411 by Google"**.
2. Speak into the phone and say where you are and what you're looking for. GOOG-411 will connect you with the business you choose.
3. When finished, press **END/cancel** button to hang up.

At any point in the call:

- To go back say **"go back"**
- To start over say **"start over"** or press *

When asked for a city and state:

- To enter city and state say the full names (for example, *"Palo Alto California"*)
- To enter a zip code say it or enter with keypad

When asked for business name or category:

- To enter a business name or category say the full names (for example, *"Joe's Pizzeria"* or *"Pizza"*)
- To spell a business name press **1** and spell with keypad (for example, *TOYS would be 8697*)

When given results:

- To navigate between results say or press the listing number
- To get more details say **"details"**
- To get help say **"help"**

Intercom Operation

(applicable only with additional handsets)

The intercom feature allows you to have a conversation with another registered handset without tying up the telephone line, allowing you to still receive incoming calls.

Making an Auto Intercom Call

1. Make sure the handset is **OFF** (not in TALK mode).
2. Press the **delete/int/conf** button on the handset.
3. Use the touch-tone pad to select the handset you want to page.

NOTE:

a) If the user has not entered the paged handset number within a few seconds, the handset shall display a paged handset number list (i.e. Handset 2, Handset 3, Handset 4, Handset 5 and Handset 6) if Handset 1 is paging the handset.

b) Even if the handset has not been registered with all 6 handsets, the paging list will display all handset numbers.

c) If the user has selected a paged handset number that has not been registered, the handset will emit an error tone and ask the user to retry again.

4. A long beep is heard and then the two handsets are immediately connected. Receiving handset shall immediately come into the auto intercom mode that both "microphone" and "speaker" of this receiving handset shall be enabled such that the user of receiving handset can freely talk and listen to the conversation.
5. When finished, press the **END** button or **delete/int/conf** button on either handset to deactivate the intercom.

NOTE: The system is expandable up to 6 handsets (by purchase of optional Model 28203 handset with recharge cradle). When 4 handsets are registered, the system can handle 2 separate intercom operations at once, for example, 1st handset intercoms with 2nd handset while 3rd handset intercoms with 4th handset.

Advanced Intercom Features

Receiving an Incoming Call During an Intercom Call

If you receive a telephone call during an intercom call, an incoming call alert tone will be heard (through the earpiece or speaker). If the user wants to answer an incoming call, they must press **END** to terminate the intercom and receive an incoming ring.

Using Intercom with External Telephone Calls

During a telephone call, you may use the intercom/paging function to page another handset and have an off line, private (two-way) intercom conversation. You may also have a three-way conversation between the external caller and the handsets, or you may transfer the external telephone call to another handset.

NOTE: Before you intercom/page another handset, you must decide whether you want to create a two-way or a three-way conversation.

Two-Way Calling

1. During an external call, press the **delete/int/conf** button, and use the touch-tone pad to enter the handset number to put an external line on hold. The user may then auto intercom with the paged handset.

NOTE: Both intercom users may speak privately. The external caller will not hear the intercom conversation.

2. When finished, press the **END** button to end the intercom call, return to the talk mode, and resume your original telephone conversation.

Three-Way Calling

1. During an external call, press the **delete/int/conf** button. The screen displays **LINE ON HOLD EXTENSION?**
2. Use the touch-tone pad to select Handset # to enter into auto intercom call with paged handset.
3. When the receiving handset connects, press the **delete/int/conf** button on the originating handset to conference with the receiving handset and the external caller. The screen displays **CONFERENCE** on the originating and receiving handsets.

NOTE: A handset can enter conference mode directly by pressing TALK/SPEAKER on the second handset during a call.

Transferring External Calls to Other Handsets

During an external call, you may transfer the external call to another handset.

1. Press the **delete/int/conf** button on the originating handset to put an external call on hold, and enter the paged handset number.
2. A long beep is heard and then the two handsets are immediately connected. Receiving handset shall immediately come into the auto intercom mode that both “microphone” and “speaker” of this receiving handset shall be enabled such that the user of receiving handset can freely talk and listen to the conversation.
3. When the receiving handset connects, press the **END** button on the originating handset to transfer the call.

Caller ID (CID)

IMPORTANT: In order to use this unit's Caller ID features, you must subscribe to either the standard Name/Number Caller ID Service or Call Waiting Caller ID Service. To know who is calling while you are on the phone, you must subscribe to Call Waiting Caller ID Service.

This unit receives and displays information transmitted by your local phone company. This information can include the phone number, date, and time; or the name, phone number, date, and time.

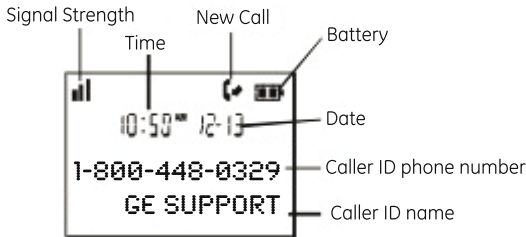

Call Waiting Caller ID

Provided you subscribe to Call Waiting Caller ID service from your phone company; if you receive an incoming call and you are using the GE multi handset system, a beep indicates the presence of a Call Waiting call on the line. The Call Waiting Caller ID information will be displayed and stored in the history of all handsets in the system.

- When you hear the call waiting beep in the handset receiver, press the **flash** button to put the current call on hold and answer the incoming call. Press the **flash** button to return to the original call.

Receiving CID Records

When you receive a call, the Caller ID information is transmitted between the first and second ring. The Caller ID information appears on the display while the phone rings, giving you a chance to monitor the information and decide whether or not to answer the call.



Storing CID Records (In CID Memory)

If you are not at home or cannot answer, your telephone's Caller ID memory stores the data for the 40 most recent calls you received so you can see who called while you were unavailable. When the 41st call is received, the oldest Caller ID record (1st call) is automatically deleted.

You may review the stored information at any time. Calls received since your last review show as  in the display.

Reviewing CID Records

As calls are received and stored, the display is updated to let you know how many calls have been received. To scroll CID records:

1. Make sure the phone is **OFF** (not in TALK mode).
2. Press the **caller ID-volume** () button to review the newest CID record.
3. Press the **caller ID-volume** () button to review the oldest CID record first.

Dialing a CID Number

1. Make sure the phone is **OFF** (not in TALK mode).
2. Use the **caller ID-volume** (▲ or ▼) button to display the desired record.
3. Press the **TALK/SPEAKER** button. The number dials automatically.

NOTE: Depending on (a) how the incoming caller's phone number is formatted when it is received, and (b) whether or not you previously pre-programmed your local area code into the set up menu, you may need to adjust the format of the incoming caller's stored phone number before making the call, press the redial/format button to adjust the number, and try again.

Available formats include:

<i>Number of digits</i>	<i>Explanation</i>	<i>Example</i>
Eleven digits	long distance code "1 " +3-digit area code +7-digit telephone number.	1-317-888-8888
Ten digits	3-digit area code + 7-digit telephone number.	317-888-8888
Seven digits	7-digit telephone number.	888-8888

Storing CID Records in Internal Memory

You may also store CID information in the phone's internal memory.

NOTE: It is important that you format CID records correctly BEFORE storing in internal memory as you cannot reformat CID records stored in memory.

1. Make sure the phone is **OFF** (not in TALK mode).
2. Use the **caller ID-volume** (▼ or ▲) button to scroll to the desired CID record.
3. Press the **mute/menu OK** button to display **ENTER NAME** and then follow "ADD RECORDS in Phonebook section" procedures from Step 3 to Step 7 to store the number.

NOTE: Press the END button once to keep the previous setting (making no changes) and return to the menu.

NOTE: If the selected CID record contains any information that is non-numeric, the unit will not allow this record to transfer to the internal user memory. The handset will display *UNABLE TO STORE*.

Deleting a CID Record

1. Make sure the phone is **OFF** (not in TALK mode).
2. Use the **caller ID-volume** (▲ or ▼) button to display the CID record you want to delete.
3. Press the **delete/int/conf** button. The display shows **DELETE CALL ID?**
NOTE: Press the END button to return to the previous screen without deleting any CID records.
4. Press the **delete/int/conf** button to erase the record showing in the display. The display shows **DELETED**.

Deleting All CID Records

1. Make sure the phone is **OFF** (not in TALK mode).
2. Use the **caller ID-volume** (▲ or ▼) button to display any Caller ID record.
3. Press and hold the **delete/int/conf** button until the screen displays **DELETE ALL?**
NOTE: Press the END button to return to the previous screen without deleting any CID records.
4. Press **delete/int/conf** button to erase all of the current CID records. The display shows **DELETED** followed by **NO CALLS**.

Phonebook

Each handset can store up to fifty records in phone book for quick dialing; each record can contain a maximum of 20-digit numbers and 14-character names (including spaces).

Review Records

1. Make sure the phone is **OFF** (not in TALK mode).
2. Press the **mute/menu OK** button to go to main menu.
3. Use the **caller ID-volume** (▲ or ▼) button to scroll to **PHONE BOOK**.
4. Press the **mute/menu OK** button to access the phonebook sub-menu.
5. Use the **caller ID-volume** (▲ or ▼) button to scroll to **VIEW RECORDS**.
6. Press the **mute/menu OK** button to confirm, all records are shown in alphabetical order.
7. Press the **caller ID-volume** (▲ or ▼) button or key in alphabet to view the records and scroll to a record to be dialed out.
8. Press the **TALK/SPEAKER** button to confirm.

Add Records

From Phonebook Sub-Menu:

1. Use the **caller ID-volume** (▲ or ▼) button to scroll to **ADD RECORDS**.
2. Press the **mute/menu OK** button to confirm. The screen displays **ENTER NAME**.
3. Use the touch-tone pad to enter a name (up to 14 characters). More than one letter is stored in each of the number keys. For example, to enter Bill Smith, press the key twice for the letter B. Press the key times for the letter I. Press the 5 key times for the letter L. Press the 5 key times for the second letter L, and press the 1 key to insert a space between the first and last name. Press the 7 key times for the letter S; press the 6 key once for the letter M; press the key times for the letter I; press the 8 key for the letter T; press the key twice for the letter H.

NOTE: If you make a mistake press the delete/int/conf button to backspace and erase the wrong character(s) or number(s).

4. Press the **mute/menu OK** button again to save your selection. The display shows **ENTER NUMBER**.

5. Use the touch-tone pad to enter the telephone number (up to 20 digits, including pauses), and press the **mute/menu** button to confirm and advance **SET MELODY** sub-menu.
6. Use the caller **ID-volume** (▲ or ▼) button to select from melody 01 to melody 10 (a testing tone is generated while making melody selection).
7. Press **mute/menu OK** button to confirm, the records are stored alphabetically in the phone book.

Inserting a Pause in the Dialing Sequence (of a Stored Number)

Press the **#pause/ringer** button on the handset's touch-tone pad to insert a delay in dialing sequence when a pause is needed to wait for a dial tone (for example, after you dial 9 for an outside line, or to wait for a computer access tone.) Each pause counts as one digit in the dialing sequence.

Edit Records

From Phonebook Sub-Menu:

1. Use the caller **ID-volume** (▲ or ▼) button to scroll to **EDIT RECORDS**.
2. Press the **mute/menu OK** button to confirm, display will show the records.
3. Use the caller **ID-volume** (▲ or ▼) button or key in alphabet to move to desired record, press **mute/menu OK** button to confirm. The screen displays **ENTER NAME**.
4. Repeat Steps 3 through 7 in "Add Records" section.

Delete Records

From Phonebook Sub-Menu:

1. Use the caller **ID-volume** (▲ or ▼) button to scroll to **DELETE RECORDS**.
2. Press the **mute/menu OK** button to confirm, display will show the records.
3. Use the caller **ID-volume** (▲ or ▼) button or key in alphabet to move to desired record, press the **delete/int/conf** button. The screen displays **DELETE?**
4. Press the **delete/int/conf** button again to confirm.

NOTE: If you don't want to change or delete a record, simply press the END button, or wait for one minute to exit automatically.

Dialing a Number from Internal Memory

1. Make sure the phone is **OFF** (not in TALK mode).
2. Press the **mute/menu OK** button to access the phonebook sub-menu.
3. Use the **caller ID-volume** (▲ or ▼) button to scroll to **VIEW RECORDS**.
4. Press the **mute/menu OK** button to confirm
5. Use the **caller ID-volume** (▲ or ▼) button or key in alphabet to move to the desired number.
6. Press the **TALK/SPEAKER** buttons, the number dials automatically.

Changing the Battery



CAUTION: To reduce the risk of fire or personal injury, use only the Thomson Inc. approved Model 5-2840 Nickel-metal Hydride battery (Ni-MH), which is compatible with this unit.

1. Make sure the telephone is **OFF** (not in TALK mode) before you replace battery.
2. Remove the battery compartment door.
3. Disconnect the cord attached to the battery pack and remove the battery pack from the handset.
4. Insert the new battery pack and connect the cord to the jack inside the battery compartment.
5. Put the battery compartment door back on.
6. Place handset in the base to charge. **Allow the handset battery to properly charge (for 16 hours) prior to first use or when you install a new battery pack. If you do not properly charge the phone, battery performance will be compromised.**

Battery Safety Precautions

- Do not burn, disassemble, mutilate, or puncture. Like other batteries of this type, toxic materials could be released which can cause injury.
- To reduce the risk of fire or personal injury, use only the **Nickel-metal Hydride** battery listed in the User's Guide.
- Keep batteries out of the reach of children.
- Remove batteries if storing over 30 days.

NOTE: The RBRC seal on the battery used in your Thomson Inc. product indicates that we are participating in a program to collect and recycle the rechargeable battery (or batteries).

For more information go to the RBRC web site at www.rbrc.org or call 1-800-8-BATTERY or contact a local recycling center.

Display Messages

The following messages show the status of the phone, provides Caller ID information, or helps you set up and use your phone.

BLOCKED NUMBER	Indicates the person is calling from a number which is blocked from transmission.
CALL SCREENING	Indicates you may use the handset to screen calls before answering the call.
CHARGING...	Indicates the handset needs to charge for a period of time before it can resume normal function.
DELETE ALL?	Prompt asking if you want to erase all CID records.
DELETE CALL ID?	Prompt asking if you want to erase the CID record showing on the display.
DELETE?	Prompt asking if you want to erase one of the 50 records stored in the phone's memory.
END OF LIST	Indicates that there is no additional information in CID memory.
ENTER NAME	Prompt telling you to enter the name for one of the 50 memory locations.
ENTER TEL NUMBR	Prompt telling you to enter the telephone number for one of the 50 memory locations.
HANDSET NAME	Prompt telling you to enter the user name for the registered handset.
HANDSET NEEDS REGISTRATION	Indicates you must register a non-registered handset prior to use.
INCOMPLETE DATA	Caller information is interrupted during transmission or the phone line is excessively noisy. Indicates no CID information was received, you are not subscribed to CID service, or CID service is not working.
LINE IN USE	Displays on handset while the line is in use.
LONG DISTANCE	Indicates CID record is from a long distance call.

LOW BATTERY	Indicates the battery needs to be charged.
MSG WAITING OFF	Indicates voice mail has been retrieved from service provider.
NEW CALL XX	XX represents the number of new CID records not reviewed.
NEW VOICE MAIL	Indicates voice mail has not been retrieved from service provider.
NO CALLS	Indicates there are no CID records in memory.
OUT OF RANGE	May indicate handset is too far away from the base or that the power has been interrupted. Move closer and check connections.
PAGING or PAGING FROM REPT	Someone pressed the page button on the base or delete/int/conf button on the handset Indicates a repeat call message. Indicates a new call from the same number was received more than once.
ROOM MONITORING....	The audio link between handsets is established.
SEARCHING	Indicates handset is searching for the base.
SPKR	Indicates the handset is in speakerphone mode.
UNKNOWN NAME/ CALLER/NUMBER	The incoming call is from an area not serviced by CID or the CID information was not sent.

Troubleshooting Guide

Caller ID Solutions

No Display

- The battery must be fully charged. Try replacing the battery.
- Make sure that the unit is connected to a non-switched electrical outlet. Disconnect the unit from the wall and plug it in again.
- You must be subscribed to Caller ID service from your local telephone company in order to receive Caller ID records.

Caller ID Error Message

- This message indicates either the presence of noise on the line, or that an invalid message has been sent from the telephone company.

Cordless Phone Solutions

No dial tone

- Check installation:
Make sure the base power cord is connected to a working electrical outlet.
Make sure the telephone line cord is connected to the base unit and the wall phone jack.
 - Connect another phone to the same modular jack; if the second phone doesn't work, the problem might be with your wiring or local service.
 - The handset may be out of range of the base. Move closer to the base.
 - Make sure the battery is properly charged (for 16 hours).
 - Ensure the battery pack is installed correctly.
 - The handset should beep when you press the talk button, and the charge indicator on the base should be lit when the handset rests in the cradle. If not, the battery may need to be charged.
 - Place the handset in the base for at least 20 seconds to reset unit.
-

Handset does not ring

- Make sure the handset ringer programmed to **ON**.
 - Move closer to the base. The handset may be out of range.
 - You may have too many extension phones on your line. Try unplugging some phones.
 - Check for a dial tone.
-

You experience static, noise, or fading in and out

- Move closer to base. The handset might be out of range.
 - Relocate the base. Make sure base is not plugged into an electrical outlet with another household appliance.
 - Charge the battery.
-

Unit beeps

- Place handset in base for 20 seconds; if it still beeps, charge battery for 16 hours.
 - Clean the charging contacts on handset and base with a soft cloth.
 - See solutions for "No dial tone."
 - Replace the battery.
-

Memory Dialing doesn't work

- Make sure you programmed the memory location keys correctly.
 - Did you follow proper dialing sequence?
-

Unit locks up and there is no communication between the handset and base

- Unplug the power adaptor from the electrical outlet and the back of the base. Remove the handset battery. Wait for 30 seconds and plug the power adaptor back into the base and electrical outlet. Reconnect the battery and charge for 16 hours.
-

Battery Solutions

If you experience any of the following problems, even after recharging the battery, you may need to replace the battery pack:

- Short talk time
- Poor sound quality.
- Limited Range
- Charge indicator fails to turn on.

Causes of Poor Reception

- Aluminum siding.
- Foil backing on insulation.
- Heating ducts and other metal construction that can shield radio signals.
- You're too close to appliances such as microwaves, stoves, computers, etc.
- Atmospheric conditions, such as strong storms.
- Base is installed in the basement or lower floor of the house.
- Base is plugged into AC outlet with other electronic devices.
- Baby monitor is using the same frequency.
- Handset battery is low.
- You're out of range of the base.

General Product Care

To keep your telephone working and looking good, follow these guidelines:

- Avoid putting the phone near heating appliances and devices that generate electrical noise (O210, motors or fluorescent lamps).
- DO NOT expose to direct sunlight or moisture.
- Avoid dropping the unit and other rough treatment.
- Clean with a soft cloth.
- Never use a strong cleaning agent or abrasive powder because this will damage the finish.
- Retain the original packaging in case you need to ship the phone at a later date.
- Periodically clean the charge contacts on the handset and base with a soft cloth.

Warranty Assistance

If trouble is experienced with this equipment, for warranty information, please contact customer service at **1-800-448-0329**. If the equipment is causing harm to the telephone network, the telephone company may require that you disconnect the equipment until the problem is resolved.

Any unauthorized repairs, changes or modifications not expressly approved by Thomson Inc. could void the user's authority to operate this product. For instructions on how to obtain a replacement unit, refer to the warranty included in this guide or call customer service at **1-800-448-0329**.

Or refer inquiries to:

Thomson Inc.
Manager, Consumer Relations
P O Box 1976
Indianapolis, IN 46206

Attach your sales receipt to this booklet for future reference or jot down the date this product was purchased or received as a gift. This information will be valuable if service should be required during the warranty period.

Purchase Date _____

Name of Store _____

Limited Warranty

What your warranty covers:

- Defects in materials or workmanship.

For how long after your purchase:

- One year, from date of purchase.
(The warranty period for rental units begins with the first rental or 45 days from date of shipment to the rental firm, whichever comes first.)

What we will do:

- Provide you with a new unit. The exchange unit is under warranty for the remainder of the original product's warranty period.

How you get service:

- Properly pack your unit. Include any cables, etc., which were originally provided with the product. We recommend using the original carton and packing materials.
- "Proof of purchase in the form of a bill of sale or receipted invoice which is evidence that the product is within the warranty period, must be presented to obtain warranty service." For rental firms, proof of first rental is also required. Also print your name and address and a description of the defect. Send via standard UPS or its equivalent to:

**Thomson Inc.
11721 B Alameda Ave.
Socorro, Texas 79927**

- Insure your shipment for loss or damage. Thomson Inc. accepts no liability in case of damage or loss.
- A new unit will be shipped to you freight prepaid.

What your warranty *does not* cover:

- Customer instruction. (Your Owner's Manual provides information regarding operating instructions and user controls. Any additional information, should be obtained from your dealer.)
- Installation and setup service adjustments.
- Batteries.
- Damage from misuse or neglect.
- Products which have been modified or incorporated into other products.
- Products purchased or serviced outside the USA.
- Acts of nature, such as but not limited to lightning damage.

Product Registration:

- Please complete and mail the Product Registration Card packed with your unit. It will make it easier to contact you should it ever be necessary. The return of the card is not required for warranty coverage.

Limitation of Warranty:

- **THE WARRANTY STATED ABOVE IS THE ONLY WARRANTY APPLICABLE TO THIS PRODUCT. ALL OTHER WARRANTIES, EXPRESS OR IMPLIED (INCLUDING ALL IMPLIED WARRANTIES OF MERCHANTABILITY OR FITNESS FOR A PARTICULAR PURPOSE) ARE HEREBY DISCLAIMED. NO VERBAL OR WRITTEN INFORMATION GIVEN BY THOMSON INC., ITS AGENTS, OR EMPLOYEES SHALL CREATE A WARRANTY OR IN ANY WAY INCREASE THE SCOPE OF THIS WARRANTY.**
- **REPAIR OR REPLACEMENT AS PROVIDED UNDER THIS WARRANTY IS THE EXCLUSIVE REMEDY OF THE CONSUMER. THOMSON INC. SHALL NOT BE LIABLE FOR INCIDENTAL OR CONSEQUENTIAL DAMAGES RESULTING FROM THE USE OF THIS PRODUCT OR ARISING OUT OF ANY BREACH OF ANY EXPRESS OR IMPLIED WARRANTY ON THIS PRODUCT. THIS DISCLAIMER OF WARRANTIES AND LIMITED WARRANTY ARE GOVERNED BY THE LAWS OF THE STATE OF INDIANA. EXCEPT TO THE EXTENT PROHIBITED BY APPLICABLE LAW, ANY IMPLIED WARRANTY OF MERCHANTABILITY OR FITNESS FOR A PARTICULAR PURPOSE ON THIS PRODUCT IS LIMITED TO THE APPLICABLE WARRANTY PERIOD SET FORTH ABOVE.**

How state law relates to this warranty:

- Some states do not allow the exclusion nor limitation of incidental or consequential damages, or limitations on how long an implied warranty lasts so the above limitations or exclusions may not apply to you.
- This warranty gives you specific legal rights, and you also may have other rights that vary from state to state.

If you purchased your product outside the USA:

- This warranty does not apply. Contact your dealer for warranty information.

Accessory Information

DESCRIPTION	MODEL NO.
AC Power adaptor	5-2812
Handset Replacement Battery	5-2840
Belt Clip	5-2829
Accessory Handset with Charge Cradle	5-2830

To place order, have your Visa, MasterCard, or Discover Card ready and call toll-free **1-800-338-0376**.

A shipping and handling fee will be charged upon ordering.

We are required by law to collect appropriate sales tax for each individual state, country, and locality to which the merchandise is being sent.

Items are subject to availability.

Index

A

Accessory Information	45
Add Records	34
Advanced Intercom Features	29
Alarm Clock	15
All Settings	22
Answering Calls	24
Area Code	17
Auto Standby	24
Auto Talk	18

B

Base	22
Base Layout	10
Base Station	13
Battery Safety Precautions	37
Before You Begin	7

C

Call Timer	24
Call Waiting Caller ID	31
Caller ID (CID)	30
Causes of Poor Reception	41
Changing the Battery	37

D

Date and Time	16
Delete Records	35
Deleting a CID Record	33
Deleting All CID Records	33
De-Registration	19
Dialing a CID Number	32
Dialing a Number from Internal Memory	36
Digital Security System	8
Display Icons	11
Display Messages	38
Do Not Disturb (D-N-D)	26

E

Edit Records	35
Equipment Approval Information	2
Exit	25

F

FCC RF Radiation Exposure Statement	4
Flash/Call Waiting	25
Front View	10

G

General Product Care	42
Global De-registration	20
GOOG411	27

H

Handset	23
Handset Layout	11
Handset Name	16
Hearing Aid Compatibility (HAC)	4

I

Important Installation Guidelines	9
Information for DECT Product Initial Setup	4 16
Inserting a Pause in the Dialing Sequence	35
Installation	8
Installing the Handset Battery	12
Installing the Phone	12
Intercom Operation	28
Interference Information	3
Introduction	7

Index

K

Key Tone 21

L

Language 17

Last Number Redial 25

Licensing 4

Limited Warranty 43

M

Making a Call 23

Making an Auto Intercom Call 28

Mute 26

P

Page 26

Paging from the Base/Group Page 26

Parts Checklist 7

Phonebook 34

Programming Functions 14

Programming the Telephone 14

R

Receiver Volume Control 26

Receiving an Incoming Call During an

Intercom Call 29

Receiving CID Records 31

Registration 18

Reset Setting 21

Review Records 34

Reviewing CID Records 31

Ringer Tone 20

Ringer Volume 21, 24

Room Monitor 14

S

Sound Setup 20

Speakerphone Operation 23

Standby Screen 14

Storing CID Records 31

Storing CID Records in Internal
Memory 32

T

Telephone Jack Requirements 8

Telephone Operation 22

Three-Way Calling 29

Tone/Pulse 17

Transferring External Calls to Other
Handsets 30

Troubleshooting Guide 39

Two-Way Calling 29

U

Using Intercom with External Telephone
Calls 29

V

Visual Indicators 22

VMWI / Visual Ringer Indicator on
Handset 23

Voicemail 22

W

Warranty Assistance 42

Visit the GE website at: www.GE.com/phones



Model 28213
00025224 (Rev. 1 DOM E)
08-23
Printed in China

Thomson Inc.
101 West 103rd Street
Indianapolis, IN 46290-1102
© 2008 Thomson Inc.
Trademark(s) ® Registered
Marca(s) Registrada(s)