

# LCD-2001VB

## Sunlight Readable 20.1" LCD Display

(1st Edition 11/25/2004 )

All information is subject to change without notice.



**1319 Dexter Avenue N.#020,**

**Seattle,WA 98109**

**TEL : 206-623-6000**

**FAX : 206-623-6609**

## Content

---

Introduction.....	3
Hardware Installation.....	3
The Display Timing.....	5
The Display Outline Dimensions.....	6
The Display Controls.....	7
The Screen Adjustment.....	8
Quick Installation & Troubleshooting Tips.....	19
Specification.....	20
Product Safety Precautions.....	21

## Introduction

---

Welcome to enjoy the fantastic sightseeing world. This new technology will bring you the whole new feeling about the “monitor”. We show here some of the major advantages of the LCD monitor. You will really find some other advantages when you use it.

## Hardware Installation

---

This chapter will guide you the correct installation procedures of your LCD monitor.

### Unpacking

After you unpack your LCD Monitor, please make sure that the following items are included in the carton and in good condition. If you find that any of these items are damaged or missing, please contact your dealer immediately.

- One LCD Monitor
- 15-pin D-sub VGA cable
- AC/DC adapter with 12V DC output & AC power cord
- Remote Control
- TV Tuner (Option)

### Installation

This analog LCD display **does not** require any special drivers. Necessary drivers are supplied by the video card manufacturer and may be found on the diskettes supplied with the video card that came with your computer. Windows 98/2000/XP drivers for both the display and the video card are supplied on the Windows 98/2000/XP CD or diskettes. Unfortunately, Microsoft did not provide a complete listing of the displays on the initial retail release. You may use the standard XGA (1024x768) as the display type. The video card must also be set up correctly in Windows 98/2000/XP and make sure the video output of the VGA card is on list in Section 6.1 or check your Video Card manual or Windows 98/2000/XP Read me file for further information on Video Card. After the question listed above is solved, we continue the setup procedure as below.

1. Turn power off both Computer and Display before making any connection.
2. Install Display on the solid horizontal surface such as a table or desk.
3. Connect the power cable and the AC/DC adapter, then connect adapter toe the back of the LCD monitor.
4. The LCD monitor comes with a 15-pin video cable; you may use this cable for both IBM PC's & compatibles and Macintosh.
5. Tighten the screws of the Display cable until the connectors are fastened securely.
6. Switch on power to the Computer system, then to the monitor.

The following picture provides the connection outline

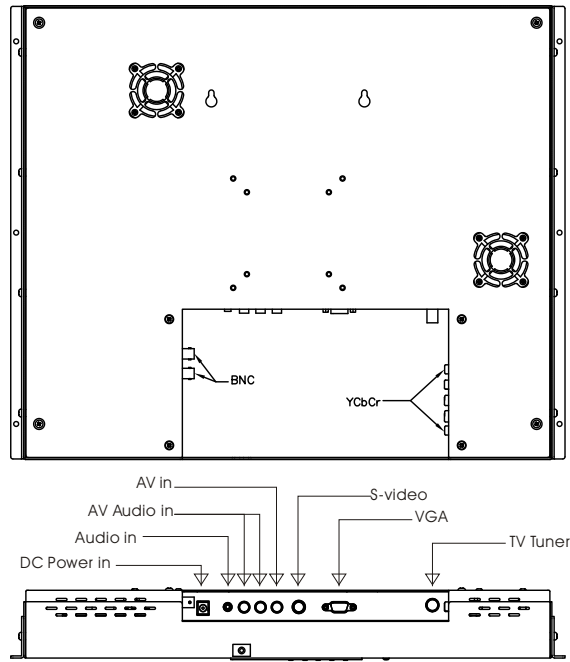

### VGA Input Pin Assignment

This section describes the pin assignment of the LCD's VGA connector. It is called 15pin Mini D-sub connector.

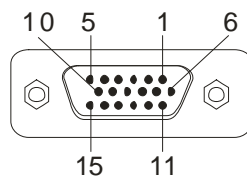

Pin No.	Signal Connector
1	Red Video Signal
2	Green Video Signal
3	Blue Video Signal
4	N.C.
5	Ground
6	Ground for red video signal
7	Ground for green video signal
8	Ground for blue video signal
9	N.C.
10	Ground
11	N.C.
12	DDC data
13	Horizontal sync signal
14	Vertical sync signal
15	DDC clock

## The Display Timing

---

### Applicable video timing

The following table lists the better display quality modes that the LCD monitor provides. If the other video modes are input, the monitor will stop working or display unsatisfactory picture quality.

VESA Modes					
Mode	Resolution	Total	Nominal Frequency ±0.5KHz	Nominal Frequency ±0.5KHz	Nominal Pixel Clock (MHz)
DOS	720x400@70Hz	900x449	31.469	70.087	28.322
VGA	640x480@60Hz	800x525	31.469	59.940	25.175
	640x480@72Hz	832x520	37.861	72.809	31.500
	640x480@75Hz	840x500	37.500	75.000	31.500
SVGA	800x600@56Hz	1024x625	35.156	56.250	36.000
	800x600@60Hz	1056x628	37.879	60.017	40.000
	800x600@72Hz	1040x666	48.077	72.188	50.000
	800x600@75Hz	1056x625	46.875	75.000	49.500
XGA	1024x768@60Hz	1344x804	48.363	60.004	65.000
	1024x768@70Hz	1328x806	56.476	70.069	75.000
	1024x768@75Hz	1312x800	60.023	75.029	78.750
IBM Modes					
EGA	640x350@70Hz	800x449	31.469	70.086	25.175
DOS	720x400@70Hz	900x449	31.469	70.087	28.322
VGA	640x480@60Hz	800x525	31.469	75.000	31.500
XGA	1024x768@72Hz	1304x798	57.515	72.100	75.000
MAC Modes					
VGA	640x480@60Hz	800x525	31.469	59.940	25.175
SVGA	832x624@75Hz	1152x667	49.725	74.551	57.2832
XGA	1024x768@75Hz	1328x804	60.927	74.927	80.000

# The Display Outline Dimensions

Unit: mm

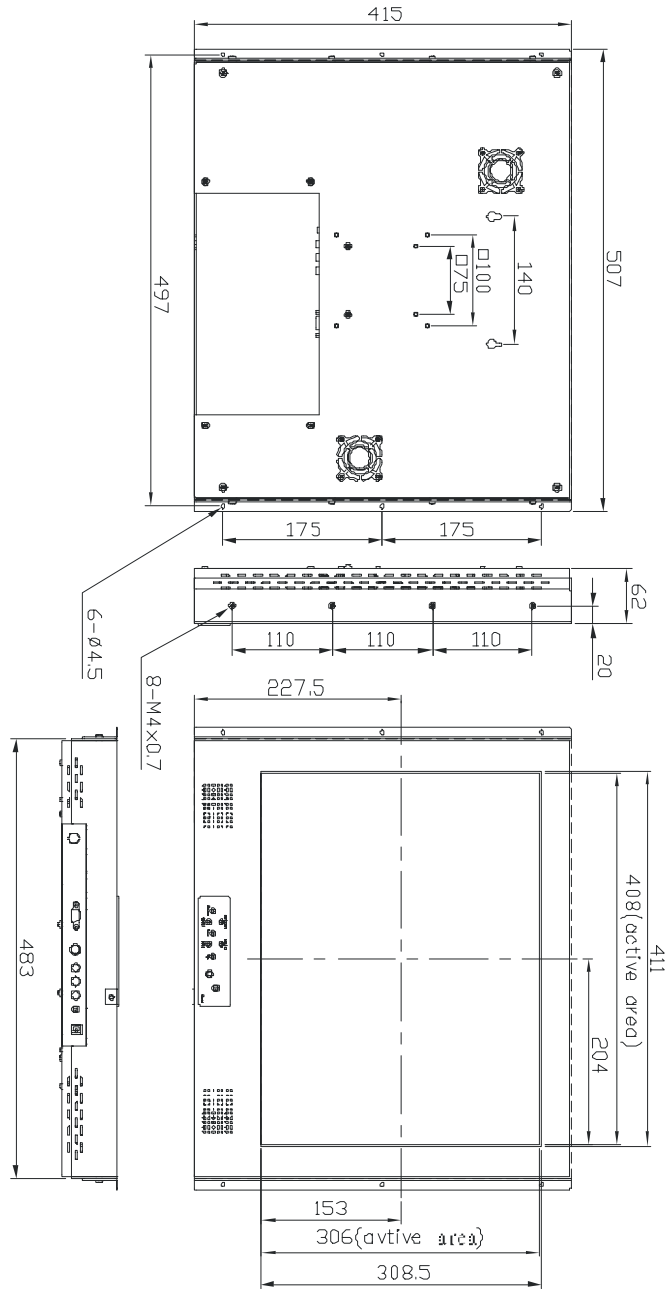

## Control Function

### Side Membrane Control Button

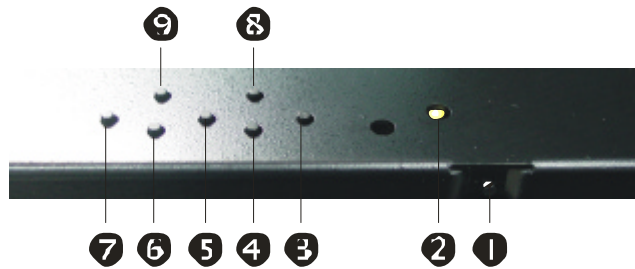

- ① **Power Key** : Power ON/Off.
- ② **Power LED** : Power ON-Green / Power Off-No.
- ③ **Up Key** : Increase item number or value of the selected item when.  
Increase volume gain when OSD is off.
- ④ **Menu Key** : Enter the main menu of the on-screen display (OSD).
- ⑤ **Down Key** : Decrease item number or item value when OSD is on.  
Decrease volume gain when OSD is off.
- ⑥ **Select Key** : Activate the selected icon or function.
- ⑦ **Source Key** : Input source select (PC, AV, S-Video, TV, Component).
- ⑧ **Channel Up Key** : Increase TV channel number
- ⑨ **Channel Down Key** : Decrease TV channel number.

### OSD Key Lock Function

To prevent unauthorized adjustment on OSD menu, LD2011 has a special key lock function.

1. Press "volume up" & "volume down" keys simultaneously for 3 seconds, the power led should turn into orange color and blinking for 3 times. The OSD has been locked.
2. Do the same procedure again to release the lock.
3. While OSD is locked, you should still be able to change the OSD with your remote controller.

## The Screen Adjustment

---

### Main Menu

You can adjust the brightness, contrast, display colors, the horizontal and vertical position of the display and OSD menu, etc. through the main menu display.



The **Down Key <** and **Up Key >** are used to scroll through items within the menu. The selected item is highlighted as the scrolling move along. The SELECT key is used to activate the highlighted item. During this state, MENU key is used to close the OSD menu from the screen.

---



## OSD Control Key

- Power key : *Power ON/OFF.*
- Menu key : *Enter the main menu of the on-screen display (OSD).*
- Down key : *Decrease item number or item value when OSD is on.*  
*Decrease volume gain when OSD is off.*
- Up key : *Increase item number or value of the selected item when .*  
*Increase volume gain when OSD is off.*
- Select key : *Activate the selected icon or function.*
- Source key : *Input source select (PC, AV, S-Video ,TV, Component).*
- Channel up key : *Increase TV channel number.*
- Channel down key : *Decrease TV channel number.*

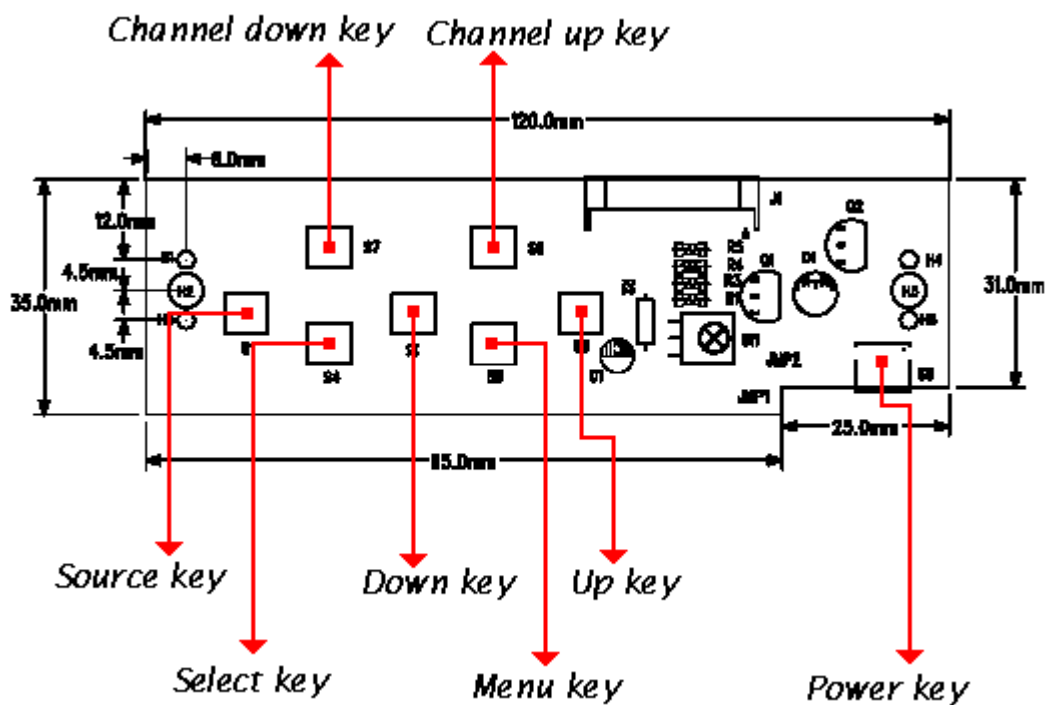

### OSD Control Function List

#### OSD For PC input

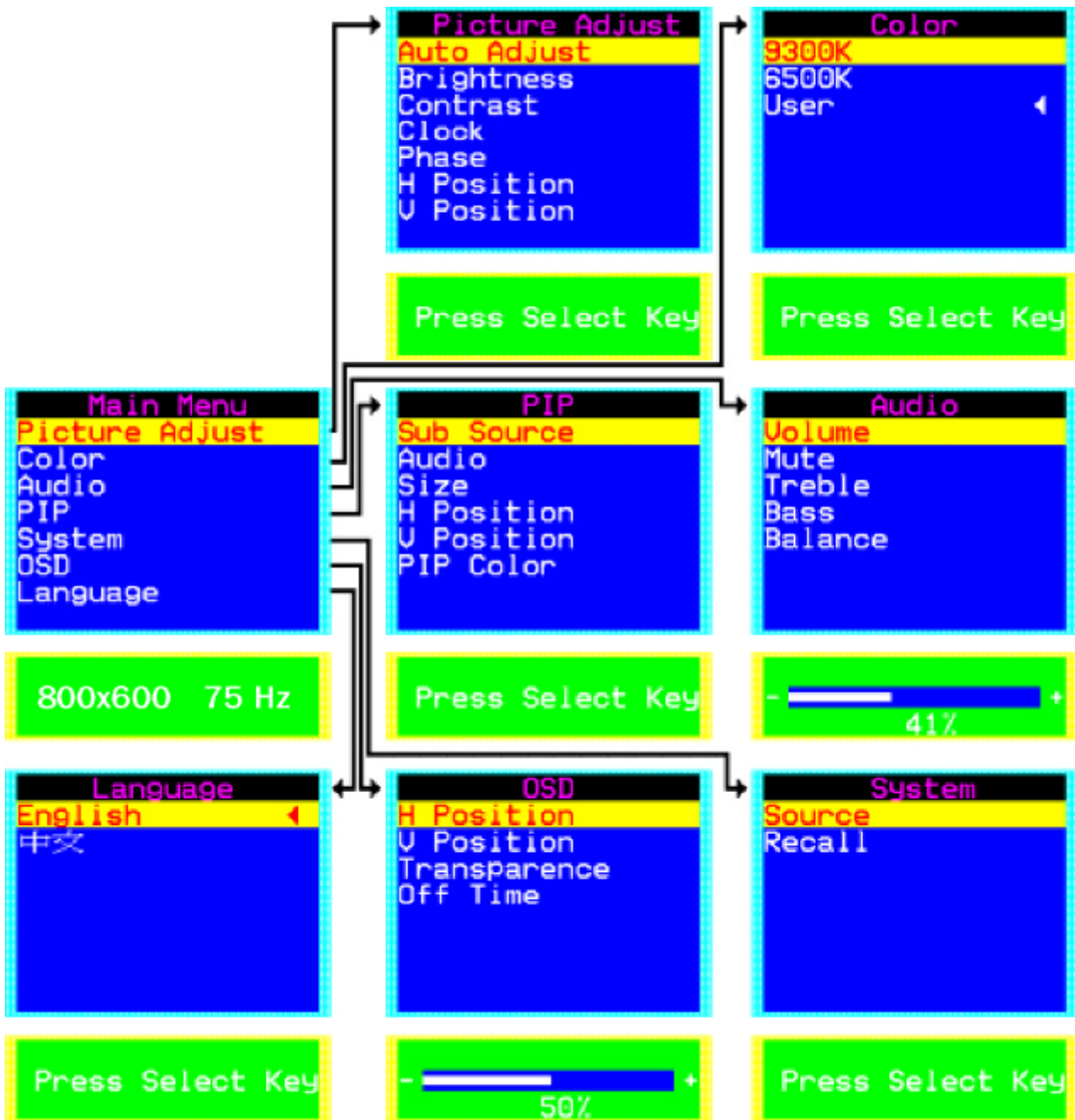

- **Main Menu**

*Press “Up” or “Down” to locate the item you desire to change, then press “Select” to make the adjustment, press “Menu” again to go back to previous menu.*

**Picture Adjust**                      *This item can adjust Auto Adjust, Brightness, Contrast, Pixel Clock, Phase, H-Position and V-Position for an optimal image.*

**Color**                                      *This item can select 9300/6500 color temperature or adjust USER color.*

**Audio**                                      *This item can adjust audio function, as Volume, Mute, Treble, Base, Balance.*

**PIP**                                        *This item can control Picture in Picture (PIP) function.As picture sub source, audio source, sub source SIZE, H-Position, V-Position, and change sub picture color setting.*

**SYSTEM**                                *This item can Select Source input (PC, AV, S-Video, TV, Component.) and Recall System data.*

**OSD**                                       *This item can control OSD window function.As OSD H-Position, OSD V-Position, OSD Transparence and OSD Off time.*

**LANGUAGE**                            *This item can Select Language (English or Tradition Chinese).*

- **Picture Adjust**

**Auto Adjust**                            *Automatically adjusts H-Position, V-Position, Pixel Clock and Phase for an optimal image.*

*Press “Select” to execute.*

**Brightness**                            *Adjusts the Brightness.*

*Press “Up” or “Down“ to adjust the parameter.*

**Contrast**                                *Adjusts the difference between the light and dark areas.*

*Press “Up” or “Down“ to adjust the parameter.*

**Clock**                                    *Adjusts the video distortion. It will appear horizontal noise on the screen while adjust the Clock.*

*Press “Up” or “Down“ to adjust the parameter.*

**Phase**                                    *Adjusts the video distortion. It will appear vertical noise*

Press "Up" or "Down" to adjust the parameter.

**Horizontal Position**

Moves the display picture.

Press "Up" to the right or press "Down" to the left.

**Vertical Position**

Moves the display picture.

Press "Up" to the up or press "Down" to the down.

● **Color**

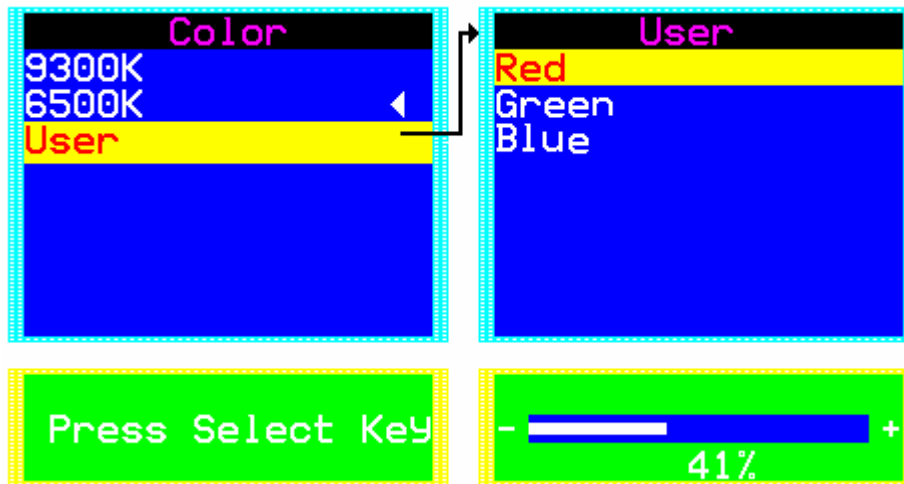

**9300K**

Select 9300 color temperature

Press "Select" to execute.

**6500K**

Select 6500 color temperature

Press "Select" to execute.

**User**

Select USER color temperature

Press "Select" to execute.

**Red**

Adjust gain of the Red color

Press "Up" or "Down" to adjust the parameter.

**Green**

Adjust gain of the Green color

Press "Up" or "Down" to adjust the parameter.

**Blue**

Adjust gain of the Blue color

Press "Up" or "Down" to adjust the parameter.

### ● *Audio*

#### *Volume*

*Adjust Volume gain*

*Press “Up” to increase or press “Down“ to decrease.*

#### *Mute*

*Set Audio mute.*

*Press “Up” to execute mute or Press “Down“ to release  
mute.*

#### *Treble*

*Adjust audio Treble .*

*Press “Up” to increase or press “Down“ to decrease.*

#### *Bass*

*Adjust audio bass .*

*Press “Up” to increase or press “Down“ to decrease.*

#### *Balance*

*Input source select.*

*Press “Up” to right or press “Down“ to left.*

● **PIP**

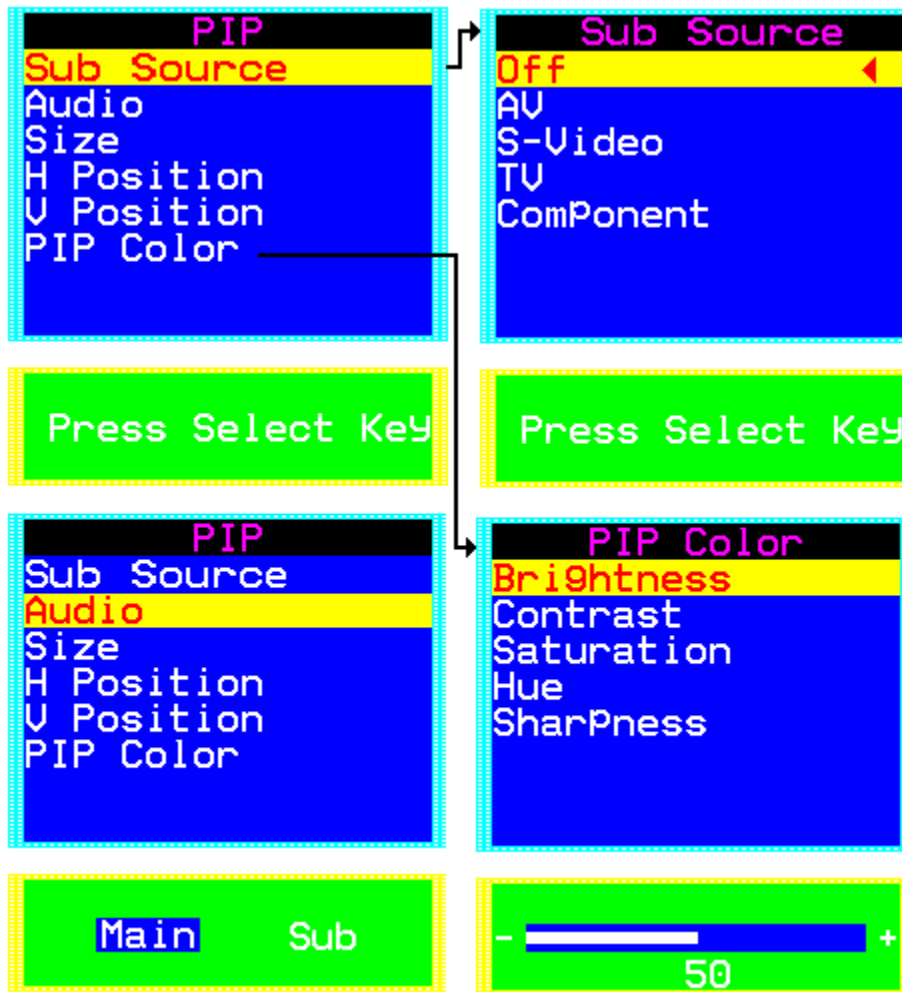

**Sub Source**

*This item can select sub source (Off, AV, S-Video, TV, and Component)*

*Press “Select” to execute..*

**Audio**

*Select audio come from Main Source or Sub Source.*

*Press “Up” to come form Main Source*

*Press “Down” to come form Sub Source.*

**Size**

*Change the Sub Picture Size.*

*It supports 4 step size( 0% ,33% ,66%, 100%)*

*Press “Up “ to enlarge the sub picture*

*Press “Down” to reduce the sub picture.*

**H-Position**

*Moves the Sub Picture.*

*Press “Up” to the right or press “Down“ to the left.*

**V-Position**

*Moves the Sub Picture.*

*Press “Up” to the up or press “Down“ to the down.*

**PIP Color**

*Change the Sub Picture color setting.*

*Press “Select” to execute.*

*Five items can be adjusted in PIP color function*

*Brightness: Adjusts the sub picture brightness.*

*Contrast: Adjusts the sub picture contrast.*

*Saturation: Between colorful and colorless.*

*Hue: Color varying*

*Sharpness: Adjusts the Sharpness.*

*Press “Up” to increase or press “Down“ to decrease.*

● **System**

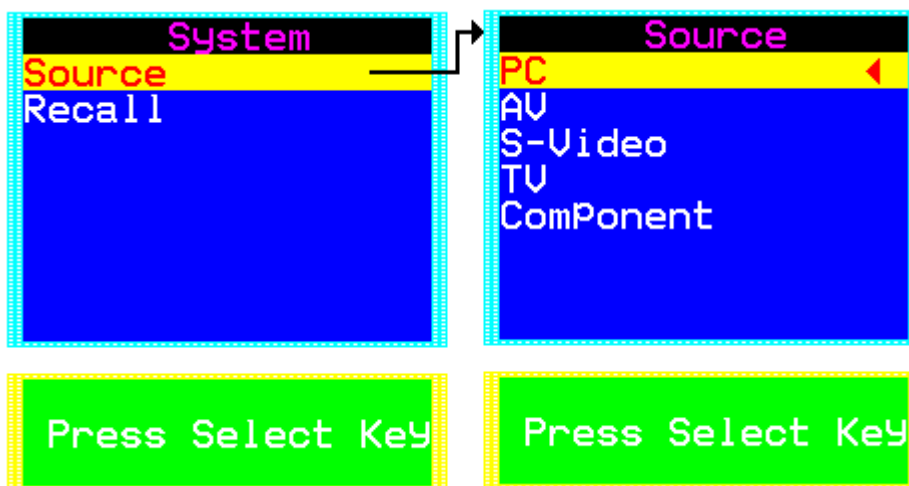

**Recall**

*Restore the default value.(The value according to the factory mode)*

*Press “Select” to execute.*

**Source**

*Input source select. (PC, AV, S-Video, TV, Component)*

*Press “Select” to execute..*

● **OSD**

**OSD H-Position**

*Adjusts the OSD position left or right*

*Press “Up” to right, press “Down“ to left.*

## The Screen Adjustment

<b>OSD V-Position</b>	Adjusts the OSD position up or down Press "Up" to up, press "Down" to down.
<b>OSD Transparence</b>	Adjusts the OSD transparency. Press "Up" or "Down" to adjust the parameter.
<b>Off Time</b>	Adjusts the OSD exit time. Press "Up" or "Down" to adjust the parameter.

### OSD For Video input

Press "Up" or "Down" to locate the item you desire to change, then press "Select" to make the adjustment, press "Menu" again to go back to previous menu.





## The Screen Adjustment

---

<i><b>Image Adjust</b></i>	<i>This item can adjust video color as Brightness, Contrast, Saturation Hue, Sharpness.</i>
<i><b>Audio</b></i>	<i>This item can adjust audio function. As Volume, Mute, Treble, Base, Balance.</i>
<i><b>System</b></i>	<i>This item can Select Source input (PC, AV, S-Video, TV, Component.) and Recall System data.</i>
<i><b>OSD</b></i>	<i>This item can control OSD window function. As OSD H-Position, OSD V-Position, OSD Transparence and OSD Off time.</i>

*All functions adjustment are same as PC mode*

**. Remote Control Function List**

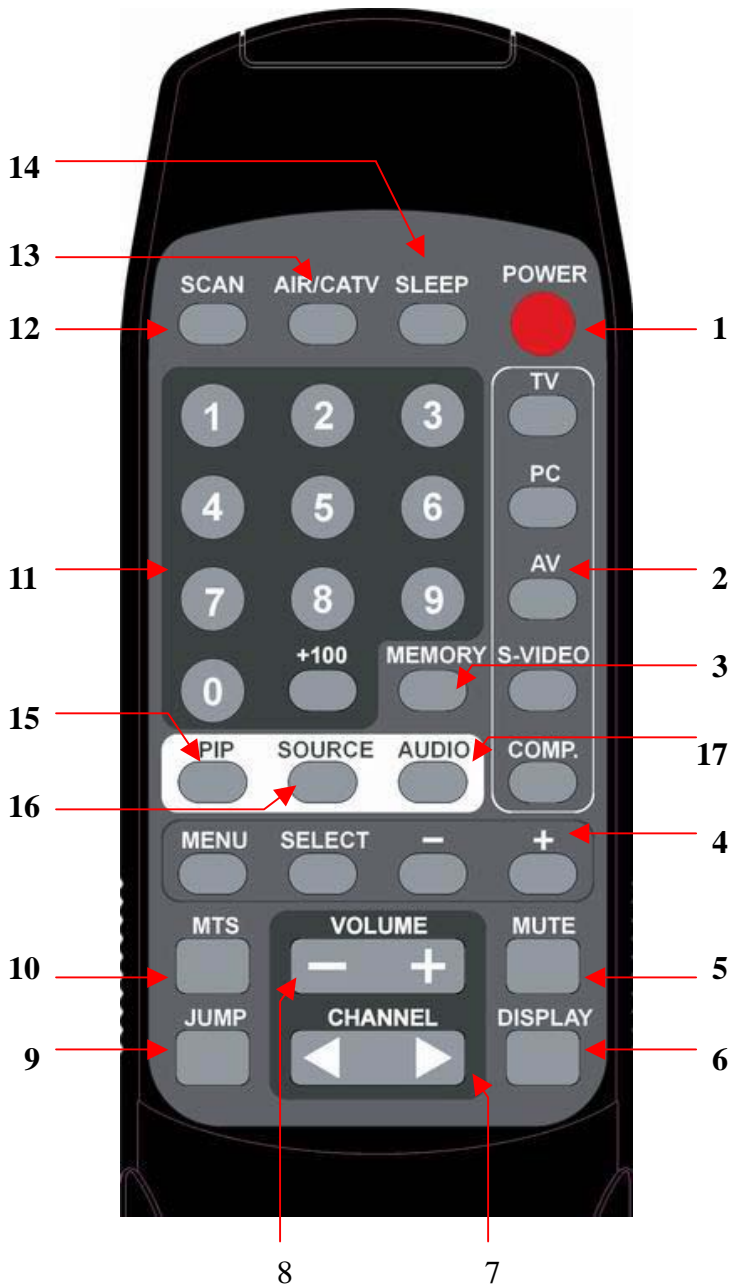

**1. POWER**

Power On/Off.

**2. Input Source Select**

TV: Select TV video input.  
 PC: Select PC-VGA input.  
 AV: Select AV video input.  
 S-VIDEO: Select S-VIDEO video input.  
 COMP.: Select Component video input

**3. MEMORY**

Channel memories or erase.

**4. OSD Control**

MENU: Turns On/Off the On-Screen Display.  
 SELECT: Execute your selection.  
 “-“: Select the Item or decrease the value.  
 “+“: Select the Item or increase the value.

**5. MUTE**

Sound On or Off.

**6. DISPLAY**

Shown a channel number in the screen.

**7. CHANNEL**

Change the channel.

**8. VOLUME**

Adjust the volume.

**9. JUMP**

Return to last the TV channel.

**10. MTS**

Multi-Channel Television sound select.  
 Stereo SAP Mono

**11. Digital key from 0 to 9 and above 100.**

Use to select a TV channel.

**12. SCAN**

Auto scan TV program.

**13. AIR/CATV**

Select the input source from Cable TV or Antenna TV.

**14. SLEEP**

Setup the sleep timer.

**15. PIP**

Enable the PIP function

**16. Source**

Select the Sub. source of Video

**17. Audio**

Select the PC/Video audio source

## Quick Installation & Troubleshooting Tips

Please follow the following descriptions step by step.  
(The 7 diagrams can also be your references):



**Step 1** Plug one terminal of the VGA cable to the signal connector at the rear of the LCD Monitor.

**Step 2** Plug the other terminal of the VGA cable to the signal connector at the rear of PC.

**Step 3** Plug Adapter output to the jack at the rear of LCD Monitor.

**Step 4** Plug the Power cord to the Adapter.

**Step 5** Connect the Power cord to power outlet.

**Step 6** Turn on the LCD Monitor and PC.

**Step 7** You can also plug in RCA jack to connect your video source like DVD or VCR.  
You can view video over PC by pressing "PIP" button on remote controller.

In the event that you experience trouble with your Display, check the following items before contacting the dealer from whom the Display was purchased. The most common problems usually involve an incorrectly an incorrect connection from the Video Card to the Display. We recommend that you also consult your Video Card User's manual during the Troubleshooting Procedure. Do not exceed the maximum refresh rate recommended for the display.

Problem	Troubleshooting Tip
No image on display screen	<ol style="list-style-type: none"> <li>1. Check that power cord of the Computer has been connected securely into wall outlet or grounded extension cable or strip.</li> <li>2. Check that power switch of the Display has been pressed and LED on the front of Display is lit.</li> <li>3. Check that Video (Signal) cable from the Display has been securely and correctly connected.</li> <li>4. Check that Video Card is firmly seated in card slot of Computer motherboard.</li> <li>5. Check that the video input from the Video Card falls within the timing range.</li> </ol>
Abnormal image	<ol style="list-style-type: none"> <li>1. Check that the video input from the Video Card falls within the timing range.</li> <li>2. Check that Video (Signal) Cable from the Display has been securely and correctly connected to the Video Connector at the rear side of the Computer.</li> </ol>
Colors of image on screen are abnormal	<ol style="list-style-type: none"> <li>1. Check that Video (Signal) Cable from the displays has been securely and correctly connected to the 15-pin Video Connector at the rear side of the computer.</li> </ol>
Disturbances on Screen	<ol style="list-style-type: none"> <li>1. OSD adjustment is incorrect. Please consult section for OSD screen adjustment procedures.</li> </ol>

***Please contact your local authorized distributors /retailers if you run into other unsolved problems.***

## Specification

---

Model No.	LCD-2001VB
Display Area	408 (H) x 306 (V) mm
LCD Display	20.1" TFT active matrix
Display Colors	16.7M colors
Luminance	1000 cd/m <sup>2</sup> (typ.)
Contrast Ratio	500:1 (typ.)
Resolution	800 x 600 (SVGA)
Pixel Arrangement	RGB (Red, Green, Blue) vertical stripe
Pixel Pitch	0.51 (H) x 0.51 (V) mm
Viewing Angle	At the contrast ratio 10:1 - Horizontal: Left side 85° (typ.), Right side 85° (typ.) - Vertical: Up side 85° (typ.), Down side 80° (typ.)
Color Gamut	At LCD panel center 60% (typ.) [against NTSC color space] Ton (black 10% white 90%)
Response Time	16 ms (Typ.)
Sync	TTL Positive or Negative
Signal Connector	15 Pin D-sub
F/R Control Button	Power Switch, Menu, Select (+,-), Auto
OSD Menu	Brightness, Contrast, H/V Position, Color, Phase, Clock, Language, Management
Power Consumption	At maximum luminance and checkered flag pattern 80W (Max)
Module Size	507(H) x 413.6 (V) x 63.1 (D) mm
Weight (Net)	8.08kg (typ.)

***Specifications subject to change without notice.***

## Product Safety Precautions

---

Follow all warnings and instructions marked on the product.

Do not use this product near water.

This display should be installed on a solid horizontal base.

When cleaning, use only a neutral detergent cleaner with a soft damp cloth.

Do not spray with liquid or aerosol cleaners.

Do not expose this display to direct sunlight or heat. Hot air may cause damage to the cabinet and other parts.

Adequate ventilation must be maintained to ensure reliable and continued operation and to protect the display from overheating. Do not block ventilation slots and openings with objects or install the display in a place where ventilation may be hindered.

This display should be operated from the type of power source indicated on the AC/DC adapter.

Do not install this display near a motor or transformer where strong magnetism is generated. Images on the display will become distorted and the color irregular.

Do not allow metal pieces or objects of any kind fall into the display from ventilation holes.

Do not attempt to service this unit yourself. Removal of the display cover may expose you to dangerous voltage or other risks. Refer all servicing to qualified service personnel.

Unplug this product from the wall outlet and refer servicing to qualified service personnel in the event that:

1. Liquid is spilled into the product or the product is exposed to rain or water.
2. The product does not operate normally when the operating instructions are followed.
3. The product has been dropped or the cabinet has been damaged.
4. The product exhibits a distinct change in performance, indicating a need for service.
5. Power cord or plug is damaged or frayed.

### **General specifications for the LCD**

The following items are neither defects nor failures.

- Response time, luminance and color gamut may be changed by ambient temperature.
- The LCD may be seemed luminance uniformity, flicker, vertical seam and/or small spot by display patterns.
- Optical characteristics ( e.g. luminance, display uniformity, etc. ) gradually is going to change depending on operating time, and especially low temperature, because the LCD has cold cathode fluorescent lamps.

**ONE YEAR LIMITED WARRANTY**

*ToteVision* warrants to the original purchaser that this product is free from defects in workmanship and material under normal use and conditions for a period of 1 year from the date of original purchase, subject to the limitations below. Should service be required by reason of any defect or malfunction during the warranty period, *ToteVision* will repair or at its discretion replace this product, without charge (except for a \$15.00 charge for handling, packing, return shipping, and subject to verification of the defect or malfunction), upon delivery of this product to the Factory Service Center listed below with proof of date of purchase. During the warranty period *ToteVision* will repair or replace, free of charge, defective units **WHICH ARE NOT DEFECTIVE DUE TO ORDINARY WEAR AND TEAR, USER ABUSE, OR OTHER CAUSES NOT ARISING OUT OF MANUFACTURER'S DEFECTS IN MATERIALS OR WORKMANSHIP.**

Before returning this product for service:

1. If it is necessary to pack the unit in other than original carton and protectors, please insure proper packaging for good protection.
2. Enclose a photocopy of your dated sales receipt, credit card statement, or other proof of the date of purchase, a description of your complaint, your name, address and day time telephone number. (Do not use P.O. Box numbers since UPS cannot deliver to P.O. Boxes.) Your warranty registration information must be on file in our office as a method of identification. If proof of original ownership is not in our records, the repairs will be treated as "out-of-warranty" and your unit will be returned to you C.O.D. for repair and handling charges.
3. For "In Warranty repairs" enclose a check or money order payable to the order of *ToteVision* for the sum of \$15.00 for return postage and handling.
4. Ship the unit prepaid to the Factory Service Center listed below.
5. If your unit needs service after the warranty period has expired, ship it prepaid and insured to the Factory Service Center below. Enclose a description of your complaint; your name, company name, address, and day time telephone number. You will be advised of estimated repair charges.

NOTE: This warranty is valid only if the product is used for the purpose for which it was designed. It does not cover:

- (i) products which have been damaged by negligence, misuse, accidents, abuse, acts of God, or units which have been modified or repaired by unauthorized persons,
- (ii) cracked or broken units or units damaged by excessive heat or cold, or units exposed to excessive UV light.
- (iii) products which have their serial numbers removed, altered or rendered illegible,
- (iv) products that have been in constant use (24 hours per day, 7 days per week) that have cold cathode florescent tubes (CCFT) that do not provide sufficient illumination,
- (v) the cost of shipping this product to the Factory Service Center and its return to you.

No warranty, expressed or implied, as to merchantability or fitness for a particular use is made beyond this Limited Warranty. *ToteVision* will not be liable for incidental or consequential damages or lost profits arising from product defects or malfunctions. This warranty is valid only in the United States of America and does not extend to owners of the product subsequent to the original purchaser. Any applicable implied warranties are also limited to 1 year and *ToteVision* will not be liable for consequential damages. (Some states do not allow limitations on implied warranties or exclusions of consequential damages, so that these restrictions may not apply to you.) This warranty gives you specific legal rights, and you may also have other rights which vary from state to state.

As a precondition to receiving any of the benefits of this limited warranty, your completed warranty registration information must be on file in our office. **IF YOUR INFORMATION IS NOT ON FILE WITH US, ALL WARRANTY CLAIMS WILL BE DENIED. TO PROTECT YOUR WARRANTY, MAIL YOUR REGISTRATION INFORMATION TODAY!** Submission of a unit determined not defective will result in a charge to you for testing and handling the unit. Thoroughly test your unit before submitting it for warranty claim repair.

Send unit to: TOTEVISION SERVICE CENTER 1319 Dexter Avenue N. # 020, Seattle, WA 98109

For further information: call (206) 623-6000 or fax (206) 623-6609

---

**WARRANTY REGISTRATION**

***Protect your Warranty by completing and mailing this form to: ToteVision, 1319 Dexter Avenue N. # 020, Seattle, WA 98109***

Model Number: \_\_\_\_\_ Serial Number: \_\_\_\_\_

Name: \_\_\_\_\_

Address: \_\_\_\_\_

City: \_\_\_\_\_ State: \_\_\_\_\_ Zip: \_\_\_\_\_

Telephone number: (\_\_\_\_\_) \_\_\_\_\_

Dealer: \_\_\_\_\_ Dealer City: \_\_\_\_\_ State: \_\_\_\_\_