

marantz®

Model LC1500 User Guide

LCD TV/Monitor

RECORD YOUR MODEL NUMBER
(Now, while you can see it)

The model and serial number of your new TV are located on the back of the TV cabinet. For your future convenience, we suggest that you record these numbers here:

MODEL
NO. _____

SERIAL
NO. _____



WARNING
RISK OF ELECTRIC SHOCK
DO NOT OPEN



WARNING :

TO REDUCE THE RISK OF ELECTRIC SHOCK DO NOT REMOVE COVER (OR BACK).
NO USER SERVICEABLE PARTS INSIDE.
REFER SERVICING TO QUALIFIED SERVICE PERSONNEL.



The lightning flash with arrowhead symbol, within an equilateral triangle, is intended to alert the user to the presence of uninsulated "dangerous voltage" within the product's enclosure that may be of sufficient magnitude to constitute a risk of electric shock to persons.



The exclamation point within an equilateral triangle is intended to alert the user to the presence of important operating and maintenance (servicing) instructions in the literature accompanying the appliance.

WARNING :

TO PREVENT FIRE OR SHOCK HAZARDS, DO NOT EXPOSE THIS PRODUCT TO RAIN OR MOISTURE.

NOTE TO CABLE/TV INSTALLER:

This reminder is provided to call the cable TV system installer's attention to Article 820-40 of the National Electric Code (U.S.A.). The code provides guidelines for proper grounding and, in particular, specifies that the cable ground shall be connected to the grounding system of the building, as close to the point of the cable entry as practical.

REGULATORY INFORMATION:

This equipment has been tested and found to comply with the limits for a Class B digital device, pursuant to Part 15 of the FCC Rules. These limits are designed to provide reasonable protection against harmful interference when the equipment is operated in a residential installation. This equipment generates, uses and can radiate radio frequency energy and, if not installed and used in accordance with the instruction manual, may cause harmful interference to radio communications. However, there is no guarantee that interference will not occur in a particular installation. If this equipment does cause harmful interference to radio or television reception, which can be determined by turning the equipment off and on, the user is encouraged to try to correct the interference by one or more of the following measures:

- Reorient or relocate the receiving antenna.
- Increase the separation between the equipment and receiver.
- Connect the equipment into an outlet on a circuit different from that to which the receiver is connected.
- Consult the dealer or an experienced radio/TV technician for help.

CAUTION:

Do not attempt to modify this product in any way without written authorization from MARANTZ. Unauthorized modification could void the user's authority to operate this product.

IMPORTANT SAFETY INSTRUCTIONS

Important safeguards for you and your new product

Your product has been manufactured and tested with your safety in mind. However, improper use can result in potential electrical shock or fire hazards. To avoid defeating the safeguards that have been built into your new product, please read and observe the following safety points when installing and using your new product, and save them for future reference.

Observing the simple precautions discussed in this booklet can help you get many years of enjoyment and safe operation that are built into your new product.

This product complies with all applicable U.S. Federal safety requirements, and those of the Canadian Standards Association.

1. Read Instructions

All the safety and operating instructions should be read before the product is operated.

2. Follow Instructions

All operating and use instructions should be followed.

3. Retain Instructions

The safety and operating instructions should be retained for future reference.

4. Heed Warnings

All warnings on the product and in the operating instructions should be adhered to.

5. Cleaning

Unplug this product from the wall outlet before cleaning. Do not use liquid cleaners or aerosol cleaners. Use a damp cloth for cleaning.

6. Water and Moisture

Do not use this product near water - for example, near a bath tub, wash bowl, kitchen sink, or laundry tub, in a wet basement, or near a swimming pool.

7. Accessories

Do not place this product on an unstable cart, stand, tripod, bracket, or table. The product may fall, causing serious injury to a child or adult, and serious damage to the product. Use only with a cart, stand, tripod, bracket, or table recommended by the manufacturer, or sold with the product. Any mounting of the product should follow the manufacturer's instructions, and should use a mounting accessory recommended by the manufacturer.

8. Transporting Product

A product and cart combination should be moved with care. Quick stops, excessive force, and uneven surfaces may cause the product and cart combination to overturn.



PORTABLE CART WARNING

9. Attachments

Do not use attachments not recommended by the product manufacturer as they may cause hazards.

10. Ventilation

Slots and openings in the cabinet are provided for ventilation and to ensure reliable operation of the product and to protect it from overheating, and these openings must not be blocked or covered. The openings should never be blocked by placing the product on a bed, sofa, rug, or other similar surface. This product should not be placed in a built-in installation such as a bookcase or rack unless proper ventilation is provided or the manufacturer's instructions have been adhered to.

11. Power Sources

This product should be operated only from the type of power source indicated on the marking label. If you are not sure of the type of power supply to your home, consult your product dealer or local power company. For products intended to operate from battery power, or other sources, refer to the operating instructions.

12. Line-Cord Polarization

This product is equipped with a three-wire grounding type alternating-current line plug (a plug having one blade wider than the other). This plug will fit into the power outlet only one way. This is a safety feature. If you are unable to insert the plug fully into the outlet, contact your electrician to replace your obsolete outlet. Do not defeat the safety purpose of the polarized plug.

13. Power-Cord Protection

Power-supply cords should be routed so that they are not likely to be walked on or pinched by items placed upon or against them, paying particular attention to cords at plugs, convenience receptacles, and the point where they exit from the product.

(Continued on next page)

IMPORTANT SAFETY INSTRUCTIONS

(Continued from previous page)

14. Outdoor Antenna Grounding

If an outside antenna or cable system is connected to the product, be sure the antenna or cable system is grounded so as to provide some protection against voltage surges and built-up static charges. Article 810 of the National Electrical Code (U.S.A.), ANSI/ NFPA 70 provides information with regard to proper grounding of the mast and supporting structure, grounding of the lead-in wire to an antenna discharge unit, size of grounding conductors, location of antenna-discharge unit, connection to grounding electrodes, and requirements for the grounding electrode.

Example of Grounding According to National Electrical Code Instructions

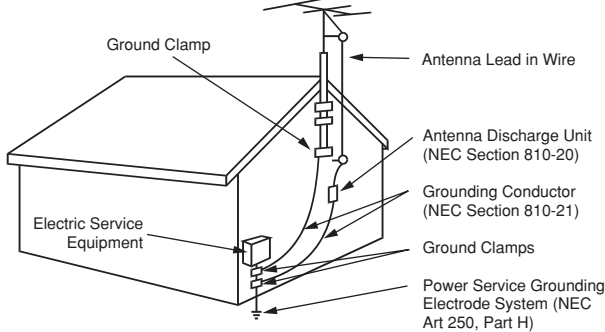

NEC - National Electrical Code

15. Lightning

For added protection for this product (receiver) during a lightning storm, or when it is left unattended and unused for long periods of time, unplug it from the wall outlet and disconnect the antenna or cable system. This will prevent damage to the product due to lightning and power-line surges.

16. Power Lines

An outside antenna system should not be located in the vicinity of overhead power lines or other electric light or power circuits, or where it can fall into such power lines or circuits. When installing an outside antenna system, extreme care should be taken to keep from touching such power lines or circuits as contact with them might be fatal.

17. Overloading

Do not overload wall outlets and extension cords as this can result in a risk of fire or electric shock.

18. Object and Liquid Entry

Never push objects of any kind into this product through openings as they may touch dangerous voltage points or short-out parts that could result in a fire or electric shock. Never spill liquid of any kind on the product.

19. Servicing

Do not attempt to service this product yourself as opening or removing covers may expose you to dangerous voltage or other hazards. Refer all servicing to qualified service personnel.

20. Damage Requiring Service

Unplug this product from the wall outlet and refer servicing to qualified service personnel under the following conditions:

- If the power-supply cord or plug is damaged.
- If liquid has been spilled, or objects have fallen into the product.
- If the product has been exposed to rain or water.
- If the product does not operate normally by following the operating instructions. Adjust only those controls that are covered by the operating instructions as an improper adjustment of other controls may result in damage and will often require extensive work by a qualified technician to restore the product to its normal operation.
- If the product has been dropped or the cabinet has been damaged.
- If the product exhibits a distinct change in performance.

21. Replacement Parts

When replacement parts are required, be sure the service technician has used replacement parts specified by the manufacturer or have the same characteristics as the original part. Unauthorized substitutions may result in fire, electric shock, or other hazards.

22. Safety Check

Upon completion of any service or repairs to this product, ask the service technician to perform safety checks to determine that the product is in proper operating condition.

23. Wall or Ceiling Mounting

The product should be mounted to a wall or ceiling only as recommended by the manufacturer.

24. Heat

The product should be situated away from heat sources such as radiators, heat registers, stoves, or other products (including amplifiers) that produce heat.

CONTENTS

INDEX

Before operating the set, please read this manual carefully.

<hr/>		
1	Safety warnings	2
	Important safety instructions	3
	Controls	6
	Basic composition of LCD TV	10
<hr/>		
2	Connecting antenna	13
	Connecting external equipment	14
	Connecting DVD player	16
	Connecting DTV	17
<hr/>		
3	Connecting PC as monitor	18
	Function checking in PC mode	20
<hr/>		
4	Using remote control	21
	Turning on the set	23
	Function checking in TV mode	24
	Setting language	25
	Closed caption function	26
	Parental control function	30
	Programming / Erasing channels	32
<hr/>		
5	Setting current time	34
	Setting Off-Timer function	36
	Setting On-Timer function	38
	Setting sleep time function	40
<hr/>		
6	Adjusting audio condition	41
	Adjusting video condition	44
<hr/>		
7	Product specifications	46

Controls

Front of the set

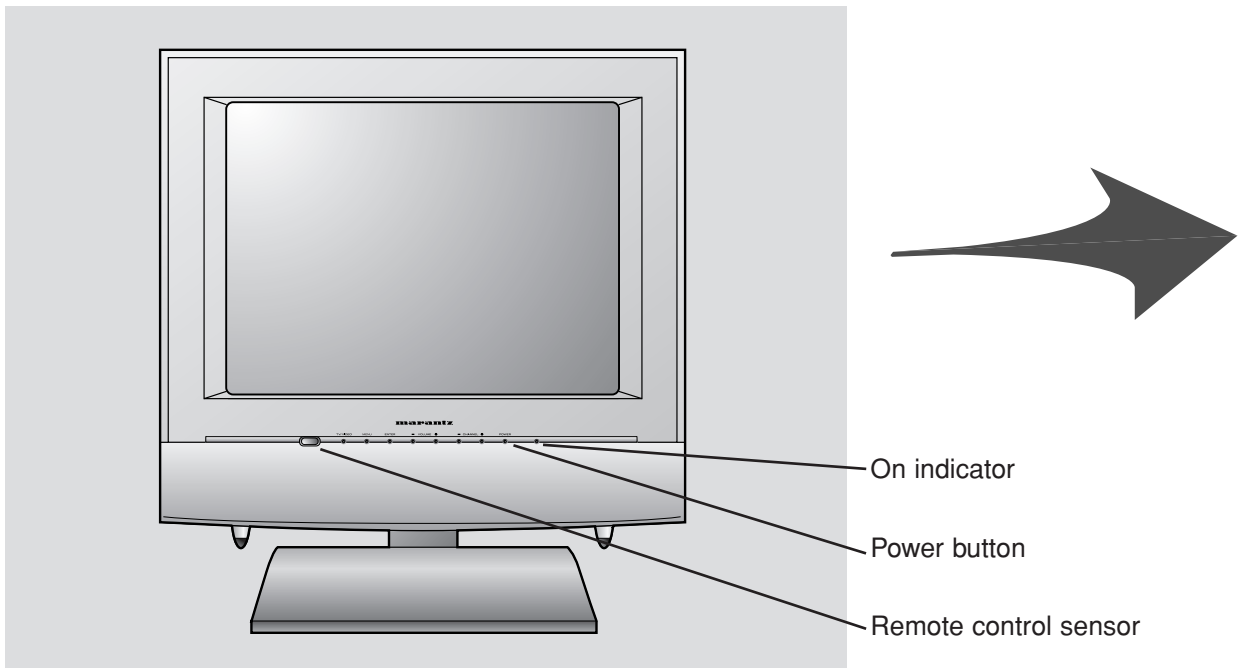

* Remove vinyl coating for protection from staining before using.

Back of the set

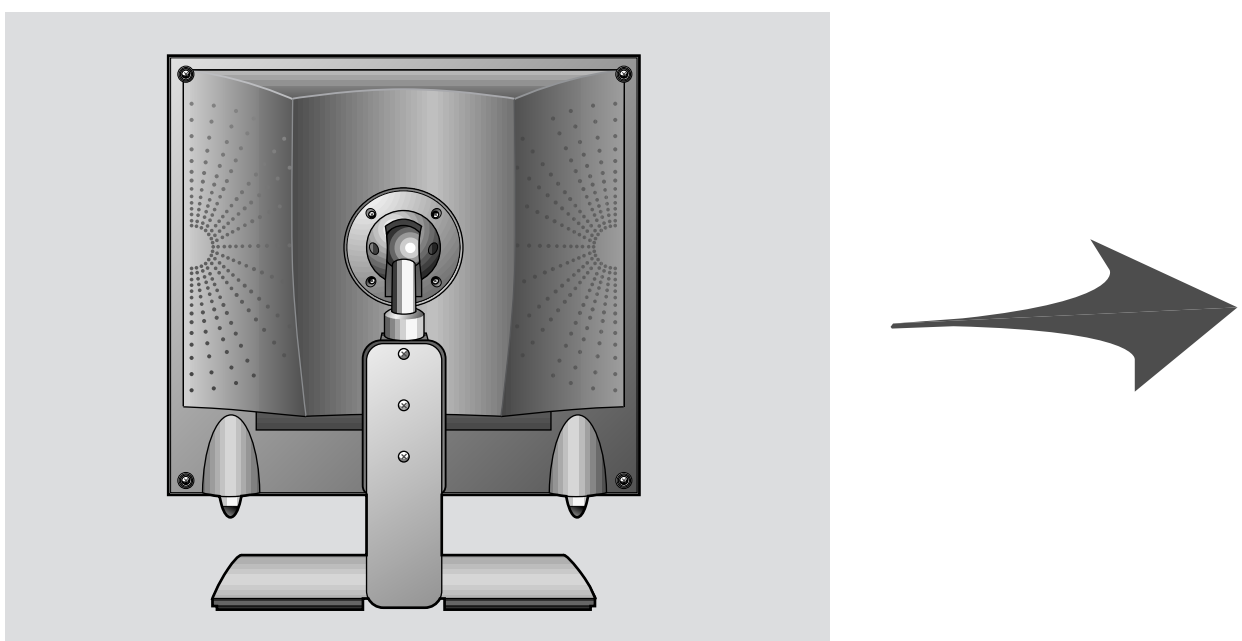

Front control panel

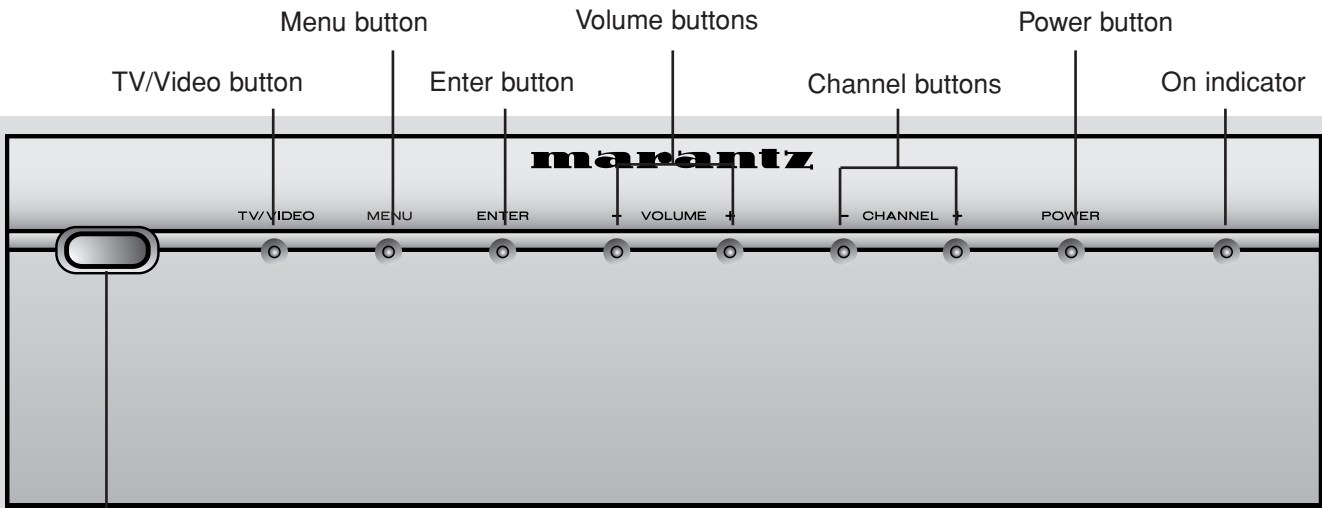

Remote control sensor

Connecting ports

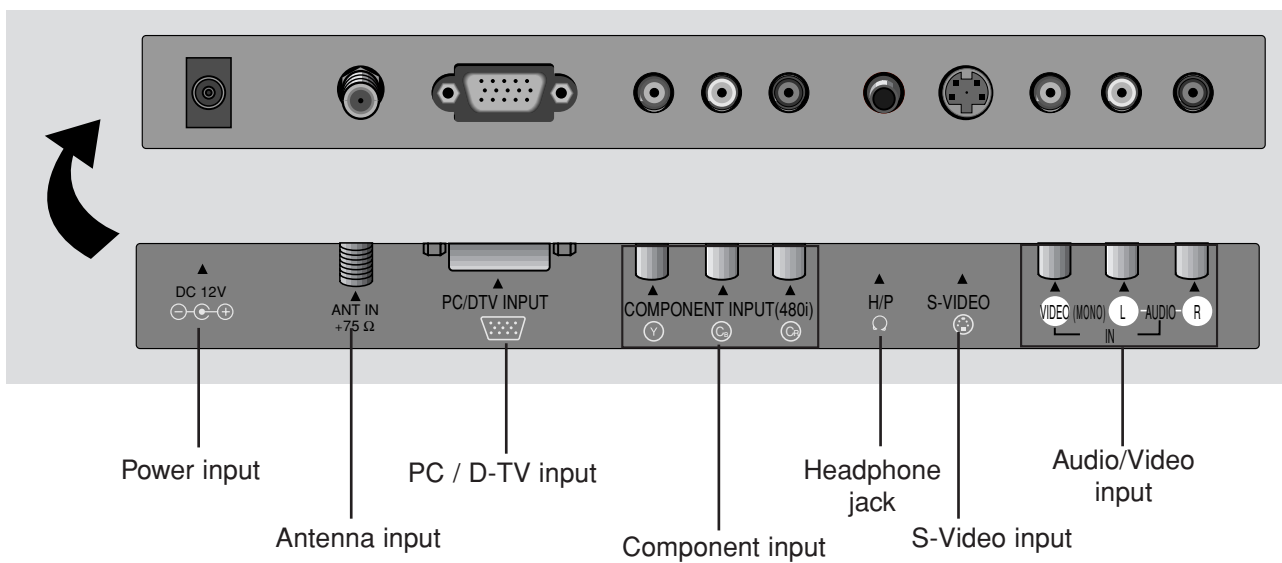

Remote Control

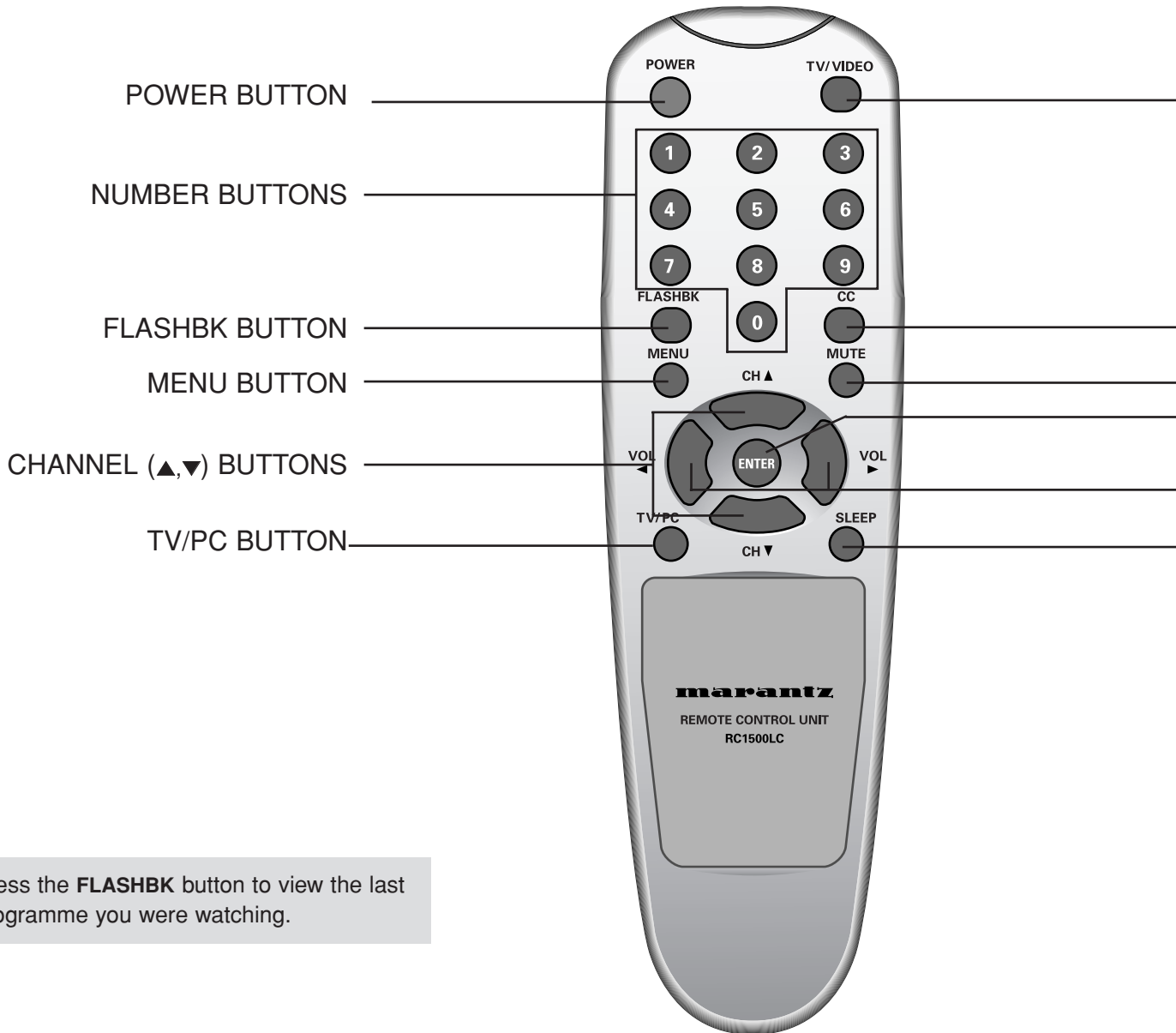

- Press the **FLASHBK** button to view the last programme you were watching.

- _____ TV/VIDEO BUTTON PAGE 15~19

- _____ CC BUTTON PAGE 28
- _____ MUTE BUTTON PAGE 43
- _____ ENTER BUTTON

- _____ VOLUME (◀, ▶) BUTTONS

- _____ SLEEP BUTTON PAGE 40

**TV/VIDEO button
on Remote Control**

⋮

* Each press of this button changes the mode as below.

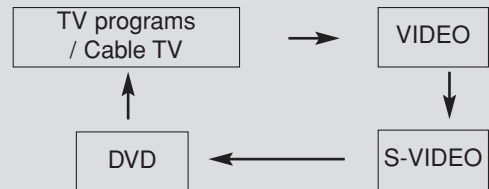

* **VIDEO, S-VIDEO, DVD** : Select each mode for watching the corresponding external equipment.

Basic composition of LCD TV

Accessories

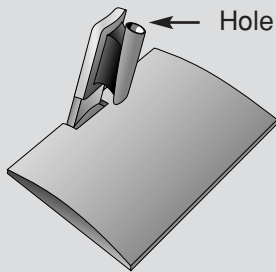
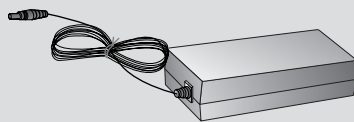

Table style stand



AC Adaptor



Remote Control
RC1500LC

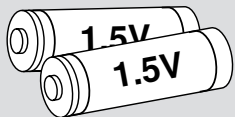

Batteries



Power cord



PC signal cable



User guide



Warranty Card
(For USA)



Warranty Card
(For CANADA)

Watching TV programs

* Please make sure to connect the power plug to the wall outlet socket after connecting the TV to the adaptor.

- a. Install the LCD TV in the correct using the installation accessories. Refer to page 12, 13.
- b. Connect the antenna cable to the antenna input port of the set.
- c. Connect the adaptor to the power input port of the set.
- d. Connect the power plug to the wall outlet socket after connecting the power cord to the adaptor.

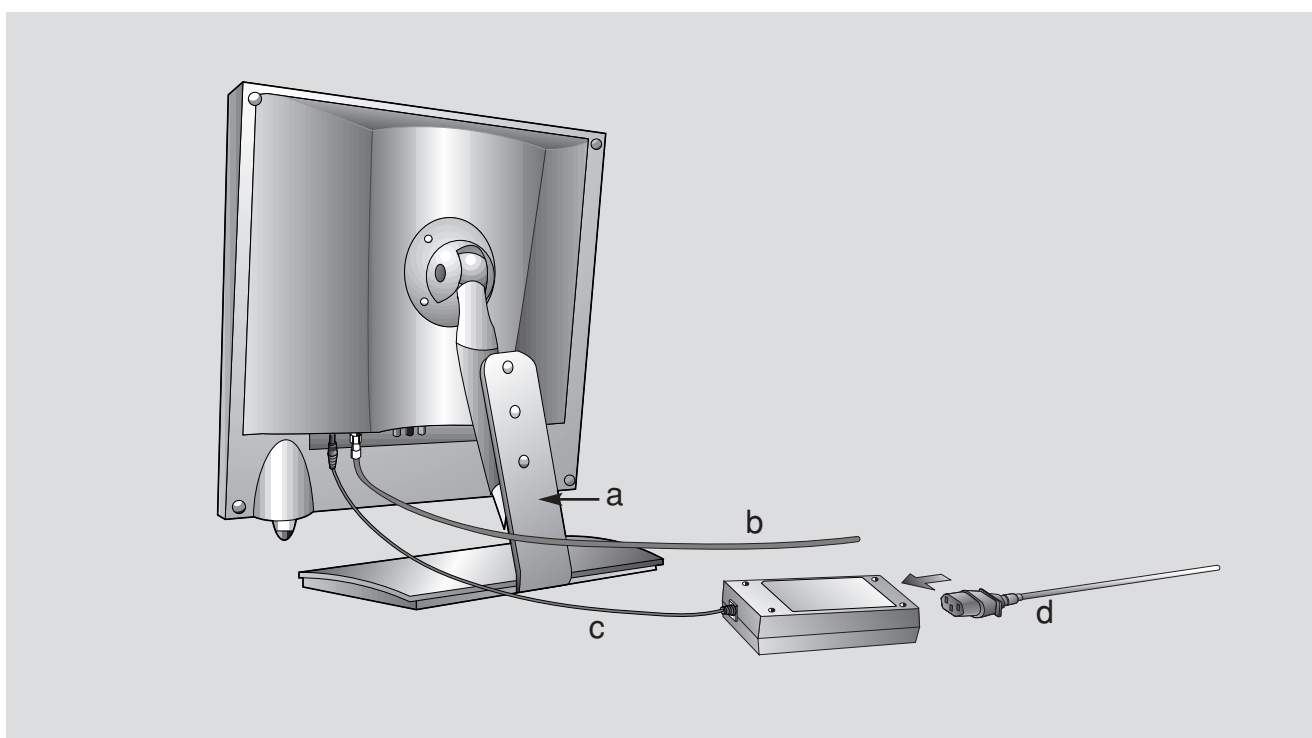

Note : If TV/monitor is cold, there may be a small “flicker” when turned on.
This is normal, there is nothing wrong with TV/monitor.

Basic composition of LCD TV

Installations

* For safety, use with table style stand only.

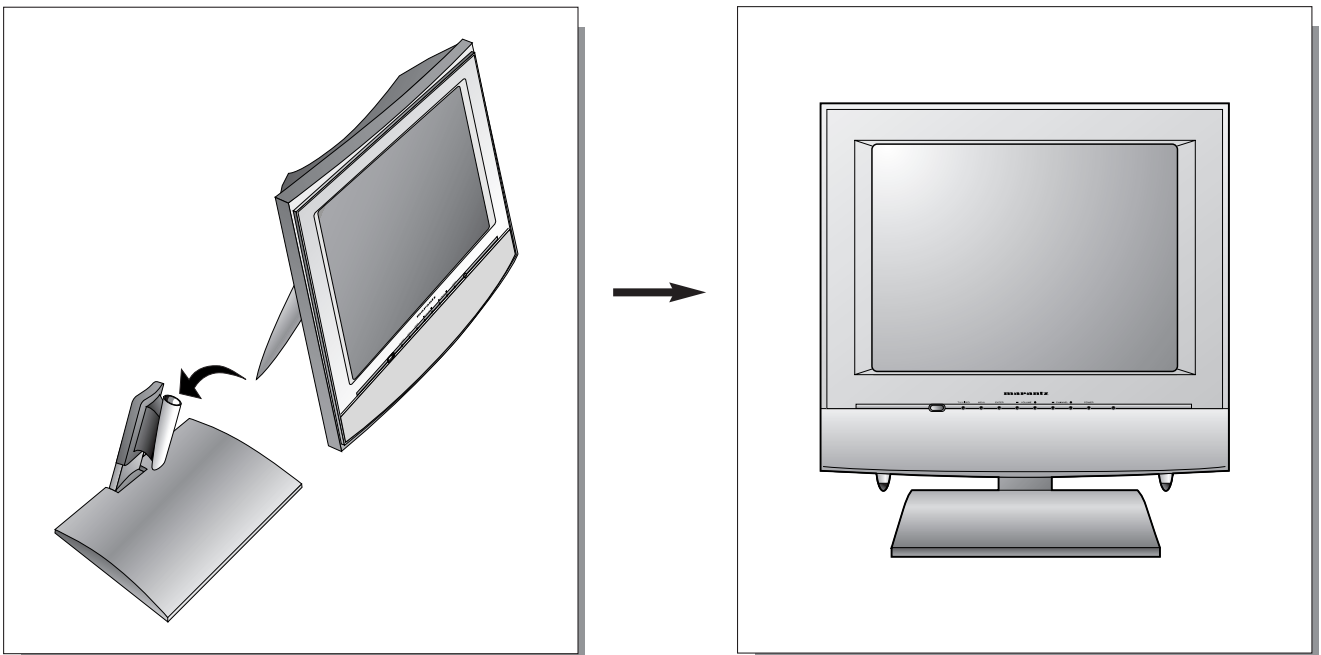

a. Place the table stand in the position you wish to install the set.

b. Put the set in the table stand.

* When you assemble the TV set with table style stand, please match the stick of TV set to the hole of the table style stand so as not to allow movement of the joint.

Connecting antenna

* To get better picture quality, adjust the direction of antenna.

Connecting to wall antenna socket

- In case of wall antenna socket in apartment houses, connect the antenna cable as shown below. (Use the correct type of antenna cable to the type of wall antenna socket.)

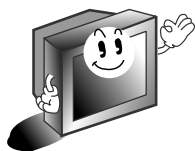
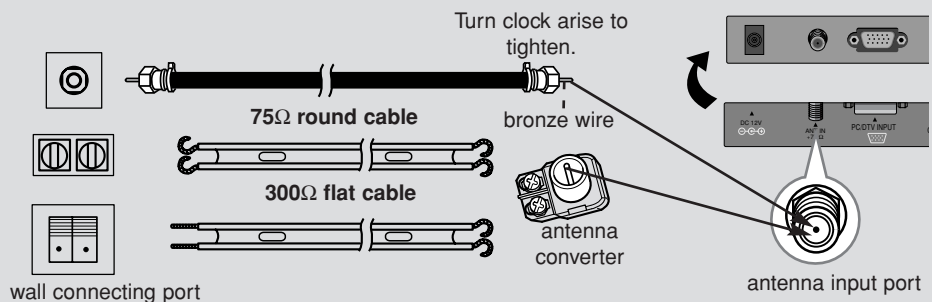
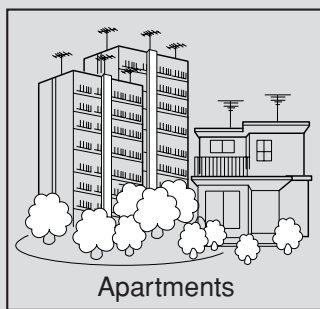

- * In case of 75Ω round cable, insert the bronze wire and then tighten the connecting nut. And in case of 300Ω flat cable, connect the twisted wire to the antenna converter and then connect the converter to the antenna input port.
- * When using 75Ω round cable, do not bend bronze. It may cause poor picture quality.

Connecting to outdoor antenna

- This type of antenna is usually used at common private houses.

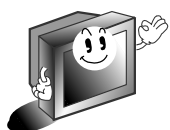
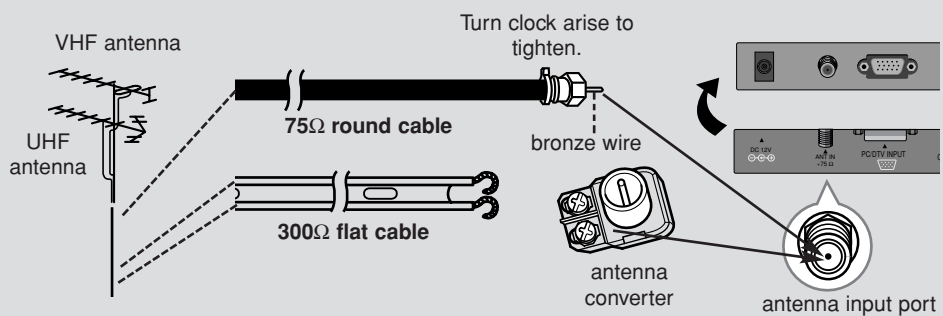
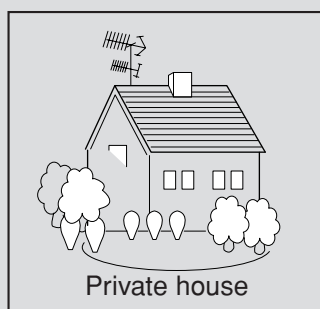

- * In poor signal area, you can get better picture quality if you install the antenna like the figure as shown right.
- * If an antenna is divided to two TV sets, use "signal divider" for connecting.

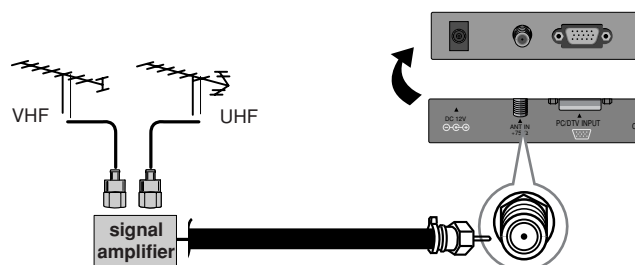

Connecting external equipment

- * TV screen is automatically converted to TV mode by pressing the channel (▲, ▼) buttons, flashbk or number buttons (0~9) when using VIDEO.
- * Please connect to other AV equipment by using input ports of the set.

Connecting VCR

1 How to connect

- Connect the audio/video output ports of VCR to the corresponding input ports of the set.

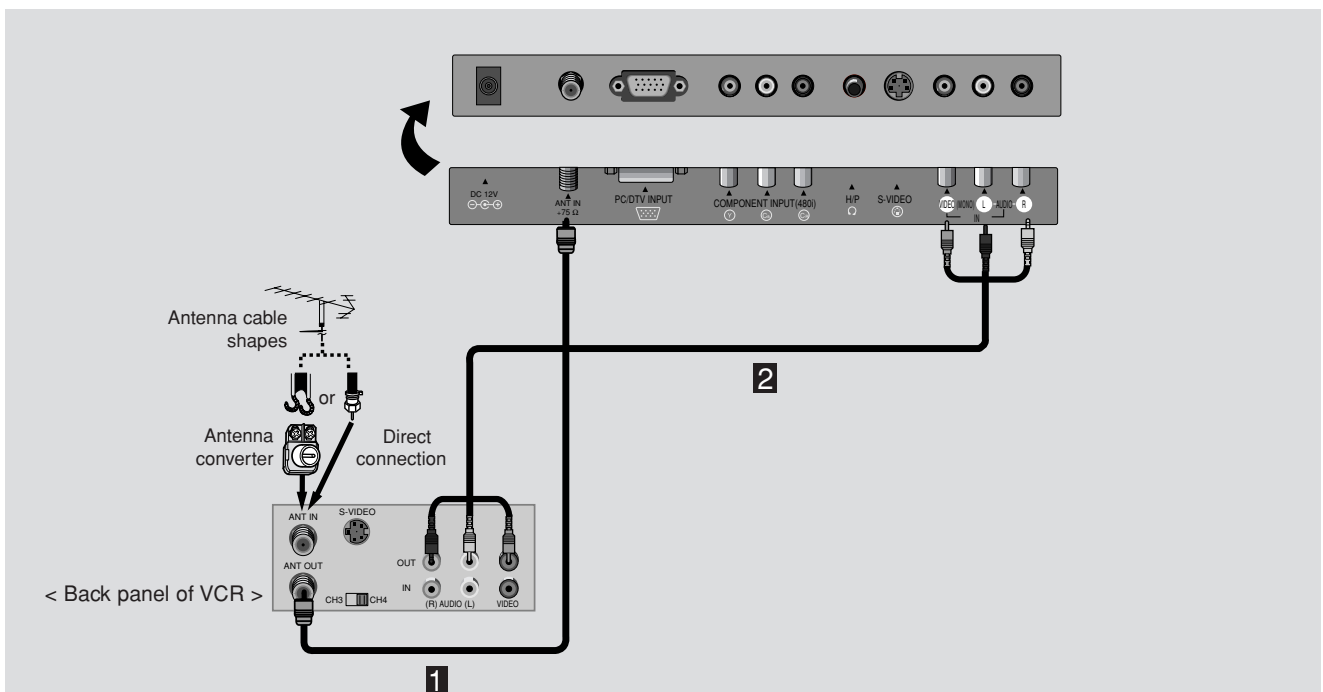

2 How to use

Watching TV programs

Turn the set on and select the channel you want.

Watching VCR

- Press tv/video button of the remote control to select [VIDEO].
 - * Select the channel 3 or 4 if you use only connection **1**.
 - * Select VIDEO if you use connection **2**.
- Insert a video tape into the VCR and press the PLAY button.

Only watching external AV source

1 How to connect

- Connect the audio/video output ports of external A/V equipment to the corresponding input ports of the set.

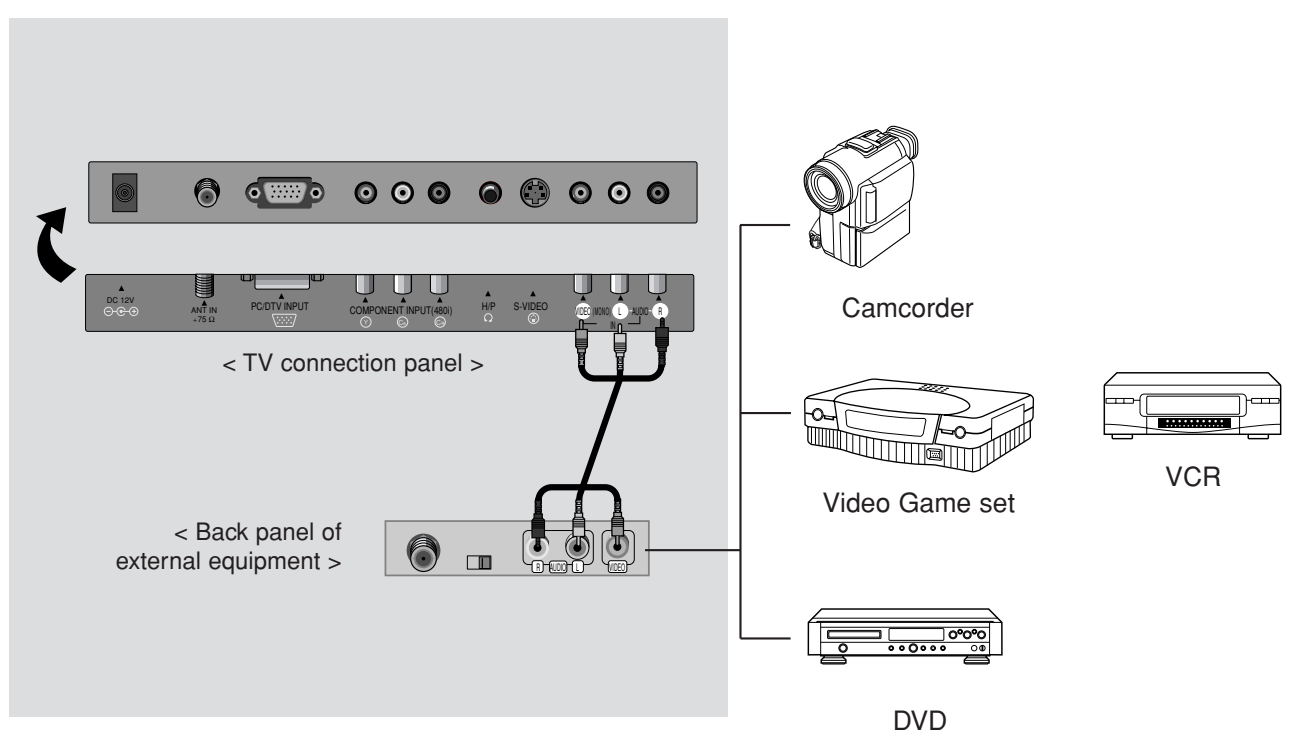

2 How to use

- Turn the set on and press **TV/VIDEO** button to select [VIDEO].

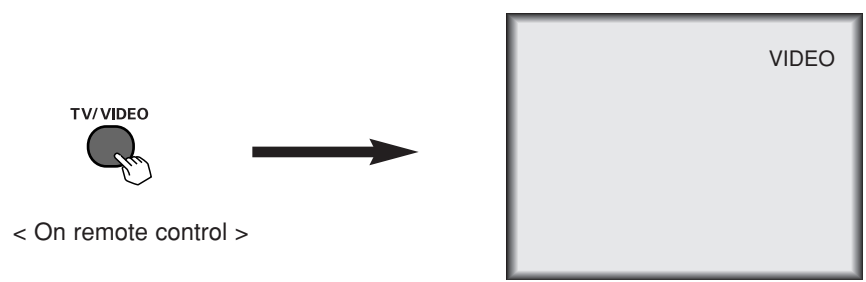

- Try this after turning on the external AV equipment.

Connecting DVD player

- Connect component video inputs to Y, Cb, Cr (480i) and audio inputs to right and left port of AV ports.

1 How to connect

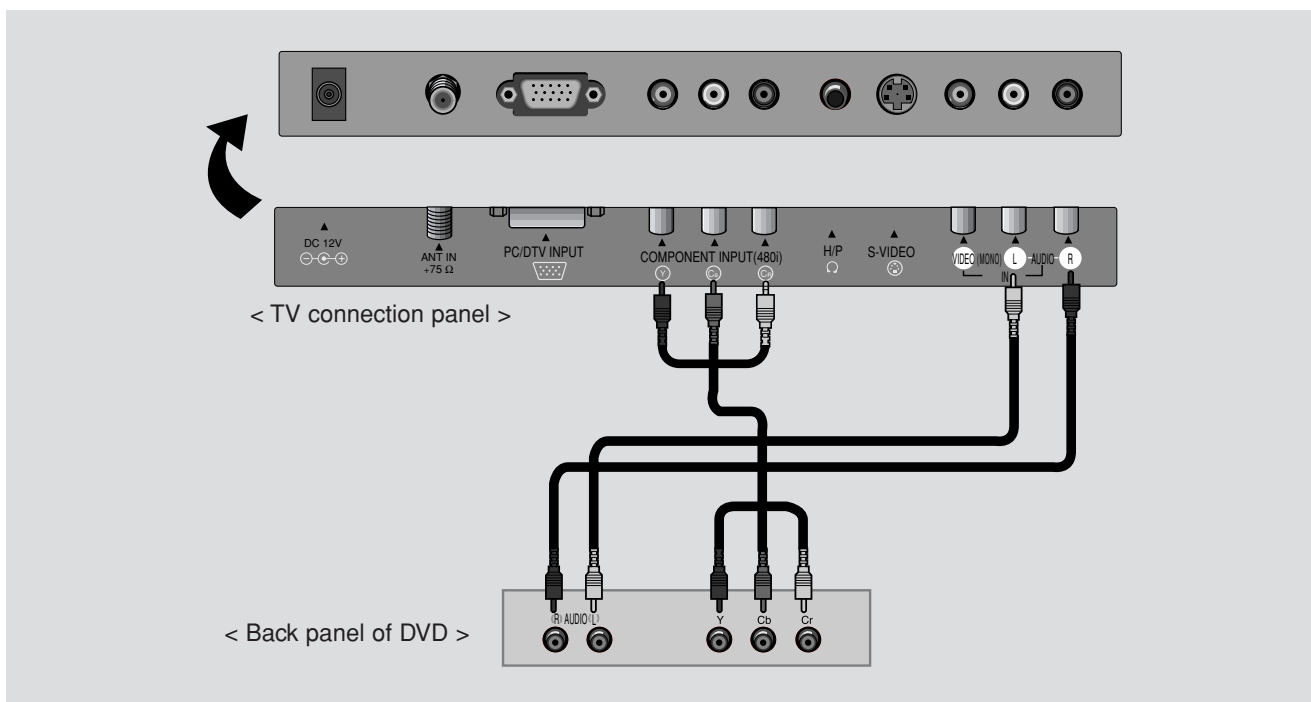

2 How to use

- Turn the set on and press **TV/VIDEO** button to select [DVD].

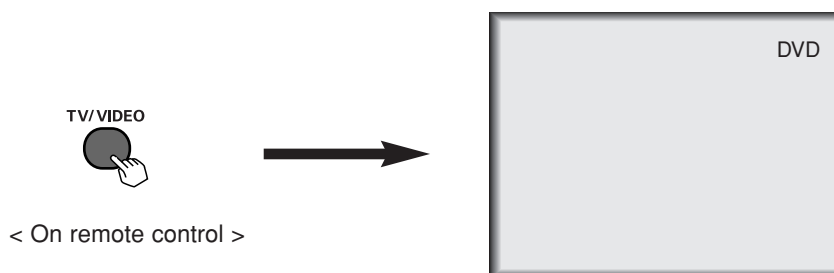

- Try this after turning on the DVD set.

Connecting DTV

* Make sure to select PC mode before operating.

1 How to connect

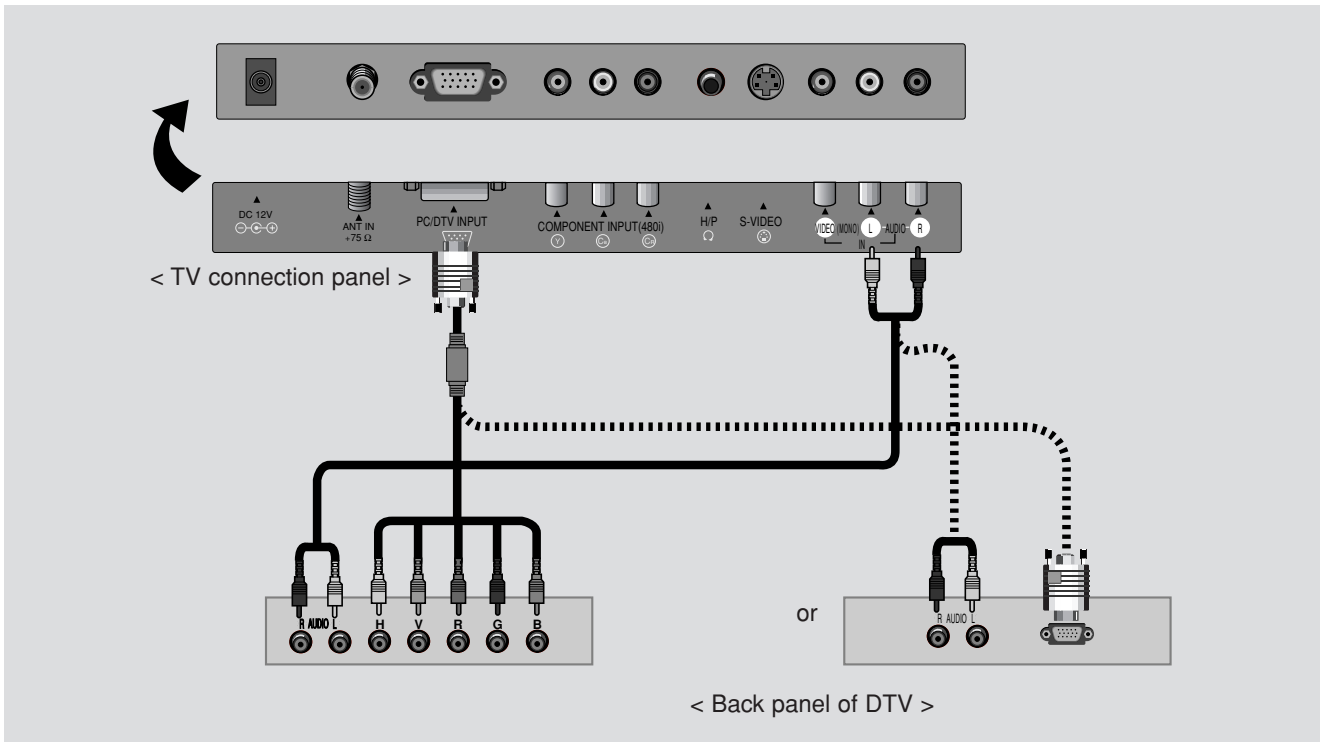

2 How to use

- Turn the set on and press **TV/PC** button to select [PC].

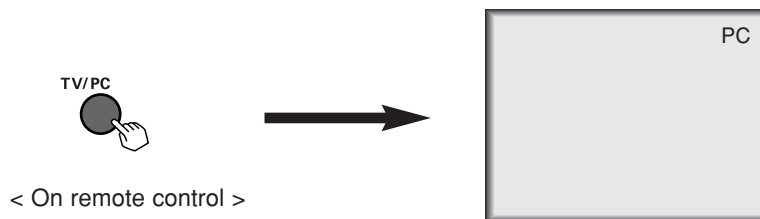

- Try this after turning on the DTV set.

Connecting PC as monitor

* Make sure to select PC mode on before operating.

1 How to connect

- Make sure to set resolution of the PC to be available before connecting. Refer to page 19.
- Connect the set to the PC with PC signal cable.
- Connect the audio ports to the PC to get PC sound.

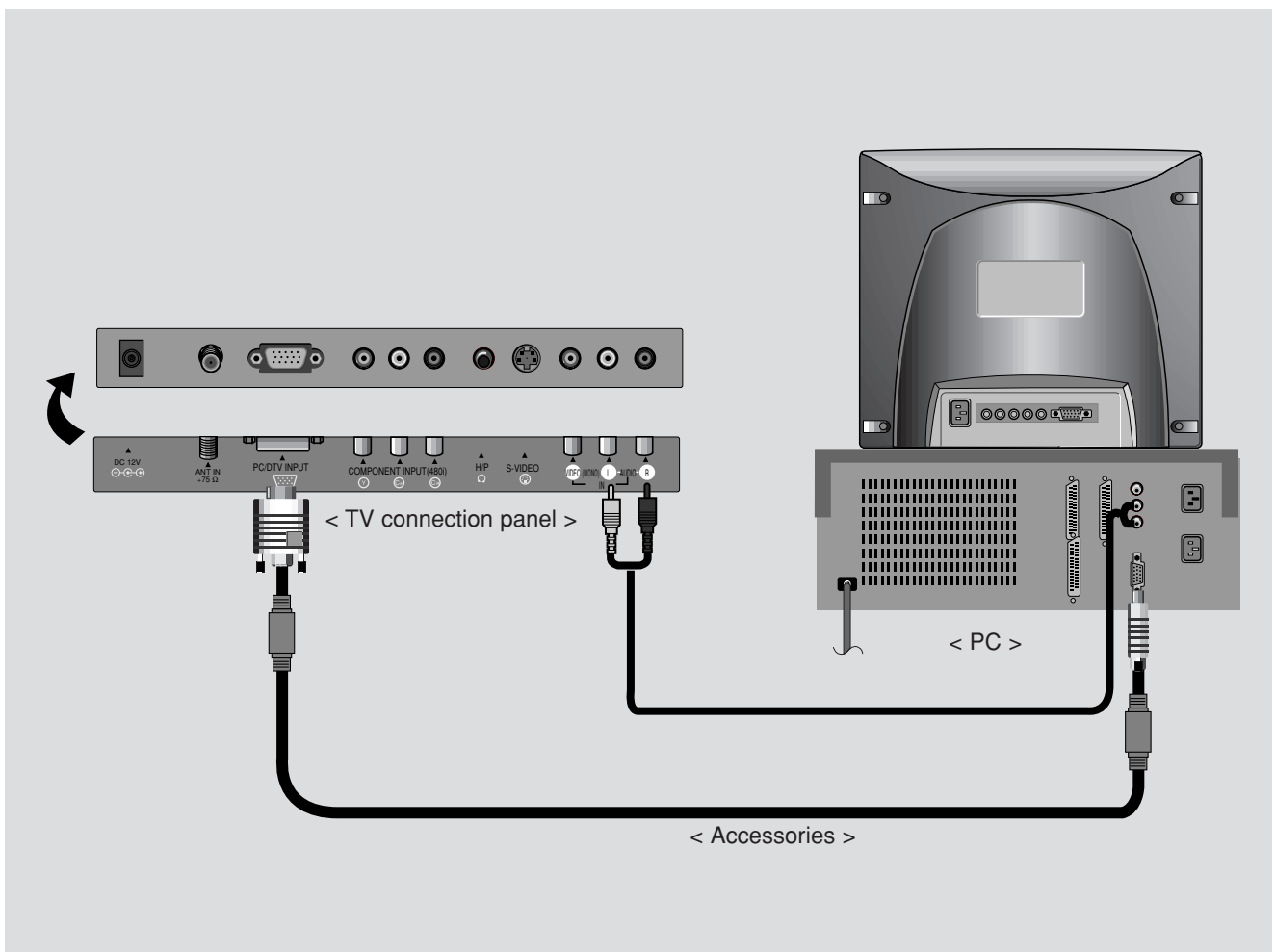

2 How to use

- Turn the set on and press TV/PC button to select [PC].

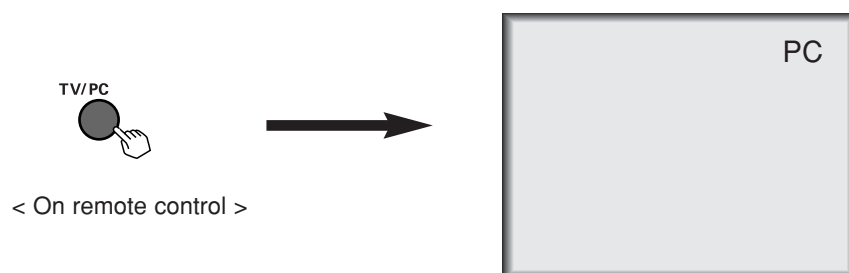

- Try this after turning on the PC.

Displayable Monitor Specification

⋮

MODE	Resolution	Horizontal Frequency(KHz)	Vertical Frequency(Hz)
VGA	640x480	31.5KHz	60Hz
	640x480	35KHz	67Hz
	640x480	37.9KHz	72Hz
	640x480	37.5KHz	75Hz
	640x480	43.3KHz	85Hz
	720x400	31.5KHz	70Hz
SVGA	800x600	35.2KHz	56Hz
	800x600	37.9KHz	60Hz
	800x600	48.1KHz	72Hz
	800x600	46.9KHz	75Hz
	800x600	53.7KHz	85Hz
(MAC)	832x624	49.7KHz	75Hz
XGA	1024x768	48.4KHz	60Hz
	1024x768	56.5KHz	70Hz
	1024x768	60.2KHz	75Hz
	1024x768	68.7KHz	85Hz

Note : If TV/monitor is cold, there may be a small “flicker” when turned on. This is normal, there is nothing wrong with TV/monitor.

Function checking in PC mode

* Make sure to select PC mode on before operating.

- 1 Press the **MENU** button. Each time you press the button you can see menus as below.

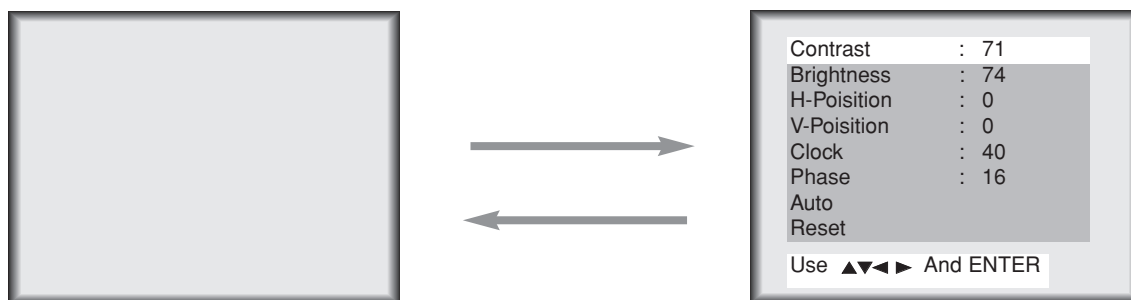

-
- 2 Press the channel (▲,▼) buttons to select a function you want to use.

Using remote control

Inserting batteries

- 1** Pull the battery cover upward in the arrow direction to remove.

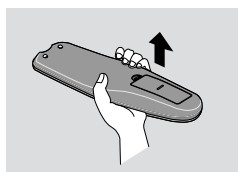

- 2** Insert the batteries with correct polarity.

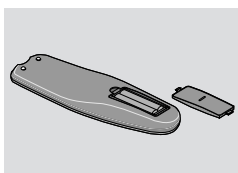

- 3** Replace the battery compartment cover.

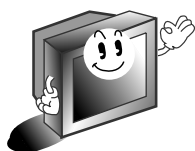
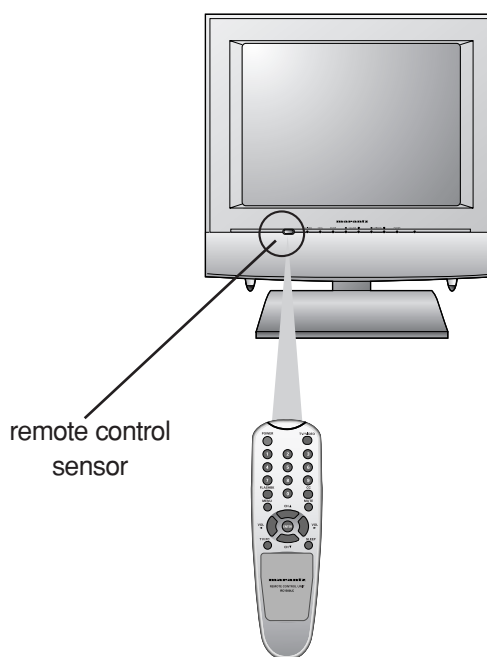
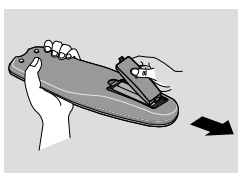

- * Apply two 1.5V alkaline batteries of AAA type. Don't mix the used batteries with new batteries.
- * Remove batteries when you don't use the remote control for long time. Liquid leakage from old battery may cause operation failure.

Notes for using remote control

Make sure there are no objects between the remote control and its sensor.



Don't place the remote control near a heater or damp place. Strong impact on remote control may cause operation failure.

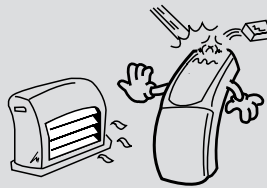

Signal from the remote control may be disturbed by sun light or other strong light. In this case, turn the set to other direction.

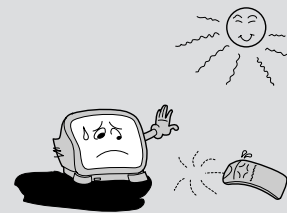

Turning on the set

* First, connect antenna cable and power cord with the adaptor.

* Press the power button and you will get stable picture and sound in a few seconds.

1 Press the **POWER** button to turn the set on.

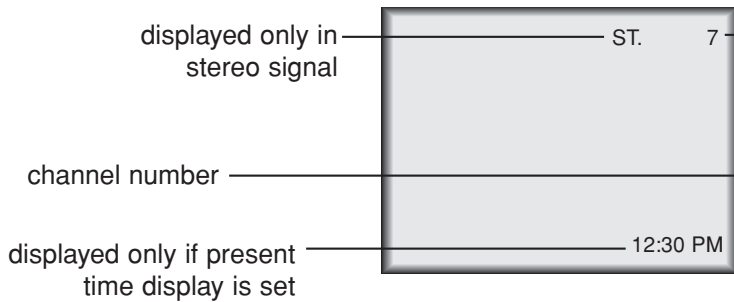

2 Press the channel (▲,▼) or number buttons to select a channel you want after memorizing received broadcasting signals in the local area.

● **Direct selecting channels**

Press number of the program as one or two digits with number buttons.

ex: channel 7 → 7 or 07

● Refer to page 32 ~ 33 to memorize channels.

3 Adjust Volume level.

- Volume (▶) button increases the level of sound.
- Volume (◀) button decreases the level of sound.

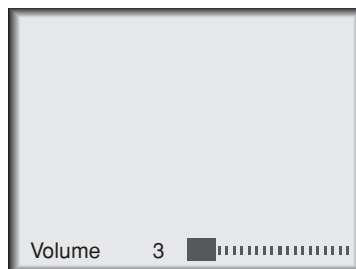

Function checking in TV mode

- 1 Press the **MENU** button. Each time you press the button you can see menus shown below.

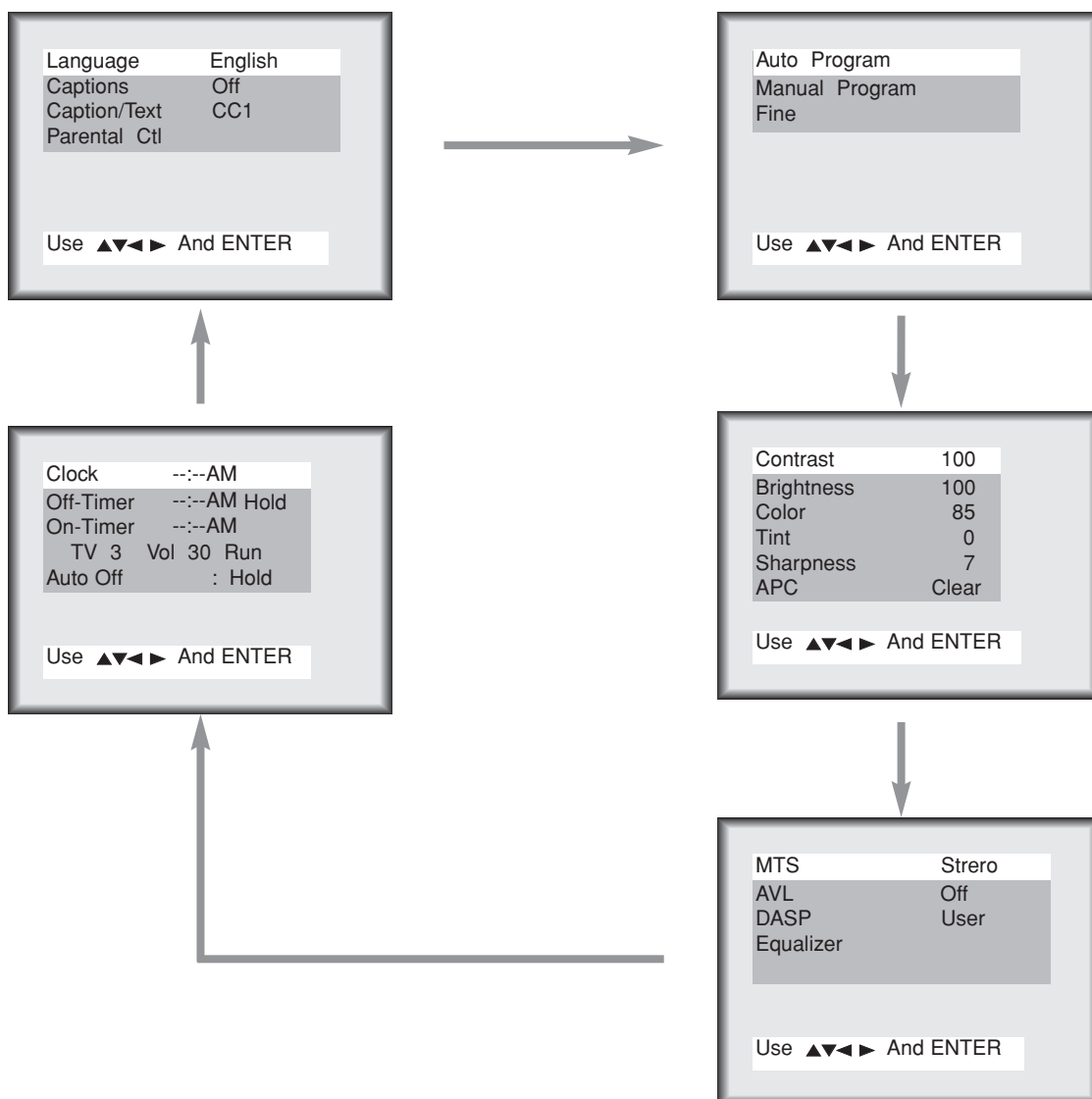

- 2 Press the channel (▲,▼) buttons to select a function you want to use.

Setting language

Language

1 Press the **MENU** button to select the screen display as below.

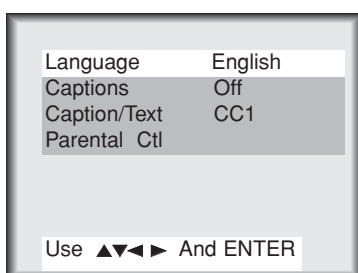

3 Press the **ENTER** button.

2 Press the channel (▲,▼) buttons to select a language you want to adjust.

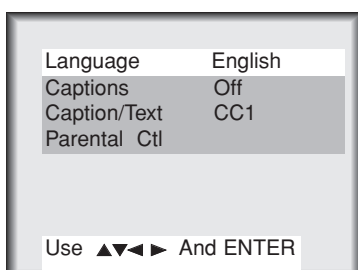

- Each press of volume (◀,▶) buttons changes the screen display as below.

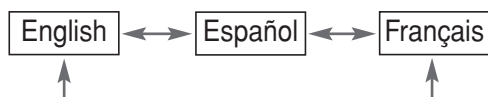

Closed caption function

Closed captioning is a process which converts the audio portion of a television program into written words which then appear on the television screen in a form similar to subtitles. Closed captions allow viewers to read the dialogue and narration of television programs.

Using Closed Captions

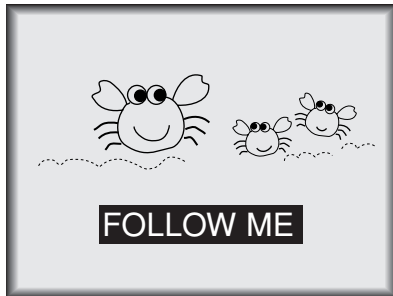

Captions are the subtitles of the dialogue and narration of television programs. For prerecorded programs, program dialogue can be arranged into captions in advance. It's possible to caption a live program by using a process called real-time captioning, which creates captions instantly. Real-time captioning is normally done by professional reporters using a machine shorthand system and computer for translation into English.

Captioning is an effective system for the hearing-impaired, and it can also aid in teaching language skills.

- The picture at left shows a typical caption.

Caption Tips

- Not all TV broadcasts include closed caption signals.
- Sometimes TV stations broadcast four different caption signals on the same channel. By selecting **FROM CC1 TO CC4**, you can choose which signal you view. **CC1** is usually the signal with the captions, while **Another mode** might show demonstration or programming information.
- Your TV might not receive caption signals normally in the following situations.

Poor reception conditions are encountered:

- **IGNITION:**
Picture may flutter, drift, suffer from black spots or horizontal streaking. Usually caused by interference from automobile ignition systems, neon lamps, electrical drills, and other electrical appliances.
- **GHOSTS:**
Ghosts are caused when the TV signal splits and follows two paths. One is the direct path and the other is reflected off tall buildings, hills or other objects. Changing the direction or position of the antenna may improve reception.
- **SNOW:**
If your receiver is located at the weak, fringe area of a TV signal, your picture may be marred by small dots. It may be necessary to install a special antenna to improve the picture.

An old, bad, or illegally recorded tape is played.

Strong, random signals from a car or airplane interfere with the TV signal.

The signal from the antenna is weak.

The program wasn't captioned when it was produced, transmitted, or taped.

Operating the Caption

- 1 Press the **MENU** button to select the screen display as below.

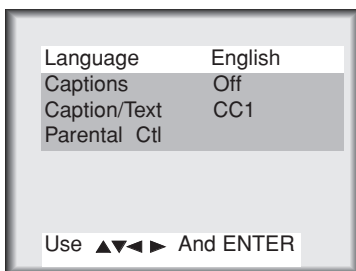

- 2 Press the channel (▲,▼) buttons to select [Caption/Text].

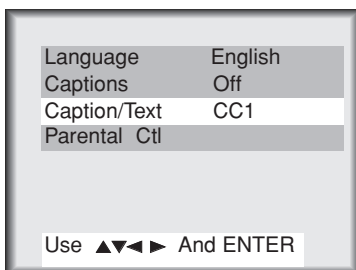

- 3 Press the volume (▶) button.

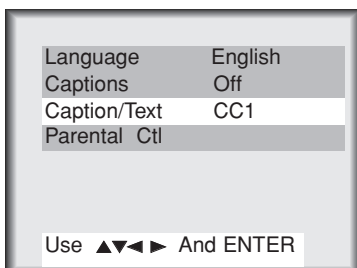

- Each time you press the volume (◀, ▶) buttons, the caption mode is displayed one by one as shown below.

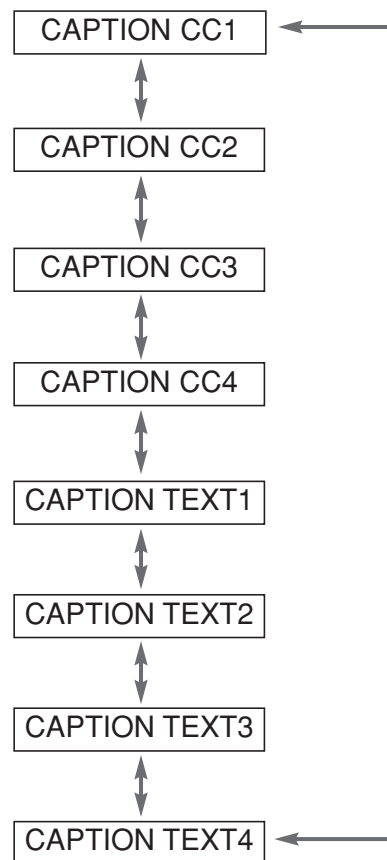

- 4 Press the **ENTER** button.

- This TV is programmed to remember which mode it was last set to, even if you switch the POWER off.

Operating the Caption

- 1 Press the **CC** button to select [Captions].

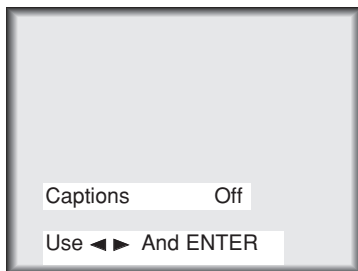

-
- 2 Press the volume (<Left>, <Right>) buttons to select [On] and press the **ENTER** button.

- Each press of volume (<Left>, <Right>) buttons changes the screen display as below.



- Captions function setting is Completed.

Using the Text Function

Text services give a wide variety of information on all kind of subjects (ex. captioned program lists, weather forecasts, stock exchange topics, news for hearing-impaired---) through the half TV screen.

But not all stations offer text services, even though they might offer captioning.

1 Repeat the steps 1-2 at page 27.

2 Press the volume (◀, ▶) buttons to select [Text 1], [Text 2], [Text 3] or [Text 4].

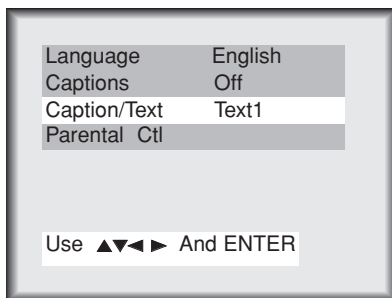

3 Press the **ENTER** button.

- In the event you receive a poor signal, an empty black box may appear and disappear, even when the text mode is selected. This is normal function in such an event.

Parental control function

The Parental Control Function (V-Chip) is used to block program viewing based on the ratings sent by the broadcast station. The default setting is to allow all programs to be viewed. Viewing can be blocked by the type of program and by the categories chosen to be blocked. It is also possible to block all program viewing for a time period. To use the Parental Control Function, the following must be set :

1. Ratings and categories to be blocked.
2. Number of hours to lock the television viewing control
3. Set a password
4. Enable the lock

V-Chip rating and categories

Rating guidelines are provided by broadcast stations. Most television programs and television movies can be blocked by TV Rating and/or Individual Categories. Movies that have been shown at the theaters or direct-to-video movies use the Movie Rating System(MPAA) only.

For Movies previously shown in theaters:

Movie Ratings:

- * Unblocked
- * G and Above (general audience)
- * PG and Above (parental guidance suggested)
- * PG-13 and Above (13 years and up)
- * R and Above (restricted)
- * NC-17 and Above (18 years and up)
- * X (adult)

If you set PG-13 and Above ; G and PG movies will be available, PG-13, R, NC-17 and X will be blocked.

For Television programs including made-for-TV movies:

General TV Ratings:

- * Unblocked
- * TV-G and Above (general audience) (individual categories do not apply)
- * TV-PG and Above (parental guidance suggested)
- * TV-14 and Above (14 years and up)
- * TV-MA (mature audience)

Children TV Ratings:

- * Unblocked
- * TV-Y and Above (youth) (individual content categories do not apply)
- * TV-Y7 (youth, 7 years and up)

Content Categories:

- * Dialog - sexual dialogue (applies to TV-PG and Above, TV-14 and Above)
- * Language - adult language (applies to TV-PG and Above, TV-14 and Above, TV-MA)
- * Sex scenes - sexual situations (applies to TV-PG and Above, TV-14 and Above, TV-MA)
- * Violence (applies to TV-PG, TV-14 and TV-MA)
- * F Violence - fantasy violence (applies only to TV-Y7)
- * No Rating (blocks all viewing)

Setting up Blocking

- 1 Press the **MENU** button to select the screen display as below.

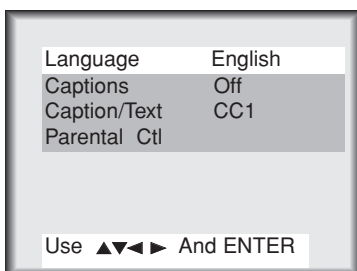

- 2 Press the channel (▲,▼) buttons to select [Parental Ctl].

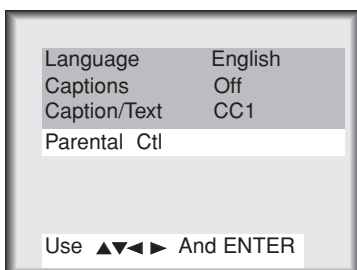

- 3 Press the volume (▶) button.

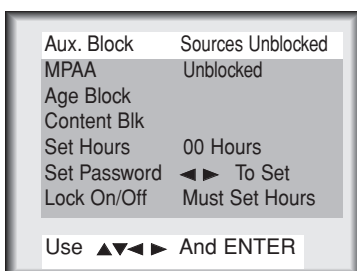

- If parental control is already set then enter the password when requested.

- 4 Press the channel (▲,▼) buttons to select the types of blocking to be set. Press the volume (◀, ▶) buttons to select the types of ratings to block.

- [MPAA], [Age] and/or [Content block] may be set.

Press the **MENU** button to return from [Age Block] or [Content Blk] setting screens.

- 5 Press the channel (▲,▼) buttons to select [Set Hours]. Press the volume (◀, ▶) buttons to set the number of hours for the blocking. (Up to 99) Press the channel (▲,▼) buttons to select [Set Password]. Enter a four digit password. Enter it again when requested.

- A new password may be chosen each time blocking is set up.

- 6 Press the channel (▲,▼) buttons to select [Lock On/Off]. Press the volume (◀, ▶) buttons to set the lock [On].

Press the **MENU** button to save the blocking setup and exit.

Programming / Erasing channels

Auto programming channels

* This function can be operated only when the set can receive input signal from broadcasting stations and the antenna cable is connected.

* [Auto programming] function memorizes all the receiving channels of terrestrial TV signals or cable TV programs.

* **If channels of general wireless TV and cable TV are duplicated, press the number buttons (0 ~ 9) to change as**

general wireless TV ↔ Cable TV

1 Press the **MENU** button to select the screen display as below.

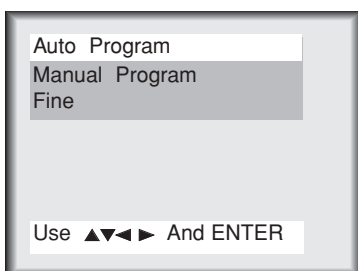

2 Press the volume (▶) button.

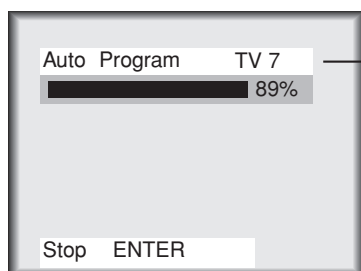

Scanning channel number is displayed.

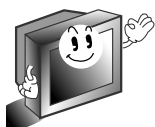

* Press the channel (▲,▼) buttons to check the memorized channels after auto programming is finished.

* If you press the **ENTER** button in auto programming, the function will stop and only channels programming up to that time will remain.

* Auto programming function can memorize only the channels which are being received at that time.

Memorizing / Erasing current channel

*You can select [Add] or [Del] for the current channel.

- 1 Press the **MENU** button to select the screen display as below. Then press the channel (**▲,▼**) buttons to select [Manual Program].

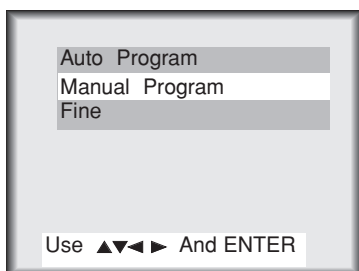

- 2 Press the volume (**◀, ▶**) buttons.

The current channel number is displayed.

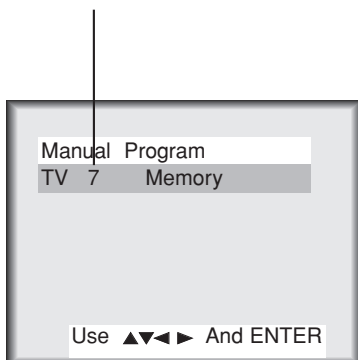

- 3 Press the channel (**▲,▼**) buttons to select a channel you want and then press the volume (**◀, ▶**) buttons to select [Memory] or [Erase].

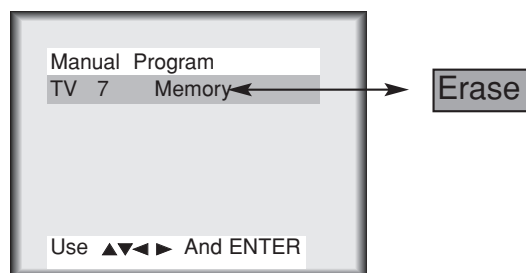

- Each time you press the volume (**◀, ▶**) buttons, you can select as below alternatively.



- 4 Press the **ENTER** button.

- The current channel is to be added / deleted.

Setting current time

* If current time setting is erased by power failure or TV is unplugged, reset it.

To set current time as 10:30 AM

- 1 Press the **MENU** button to select the screen display as below.

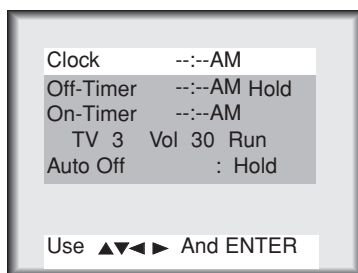

- 2 Press the channel (▲,▼) buttons to select [Clock].

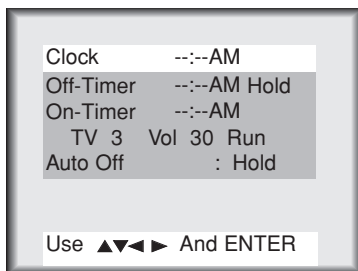

- 3 Press the volume (▶) button.

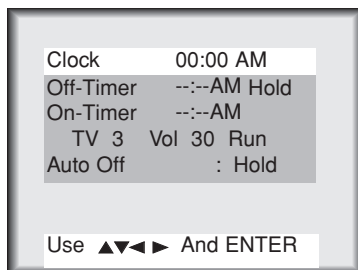

4 Press the channel (▲,▼) buttons to select current hour.

- If you hold the ► button, the hour display is changed in the sequence of AM 1 → AM 2 → ...PM12 → PM 1 ... → AM 12, and changed in the reverse sequence for ▼ button.
- Select [AM 10].

5 Press the volume (►) button.

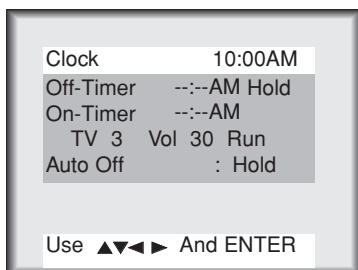

6 Press the channel (▲,▼) buttons to select current minute. And press the ENTER button.

- If you hold the ► button, the minute display is changed in the sequence of 00 → 01 → 02 ...58 → 59, and changed in the reverse sequence for ► button.
- Select [30] and press the ENTER button to complete the setting.
- Time is progressed from the point of pressing the ENTER button.
- Press the ENTER button again and the screen display is disappears.

To check current channel, time and sound status (stereo or dual)

- Press the ENTER button.

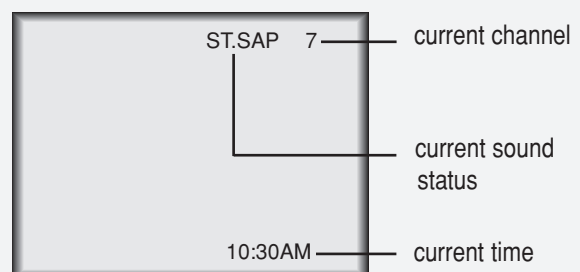

- Press the ENTER button again to release.



- * Current time is not displayed if current time is not set.
- * Stereo or dual sound is displayed only when receiving the correspondent input signal.
- * Above displays disappear after a few seconds.

Setting Off-Timer function

*Timer function can be operated only if current time has been already set.

*Off-timer function is prior to on-timer function if they are set to the same time.

Turning off at 11:30 PM by off-timer function

- 1 Press the **MENU** button to select the screen display as below.

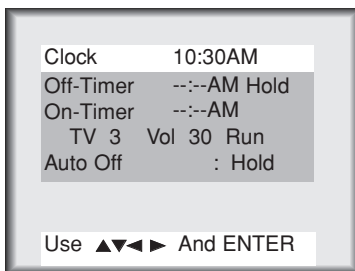

- 2 Press the channel (▲,▼) buttons to select [Off-Timer].

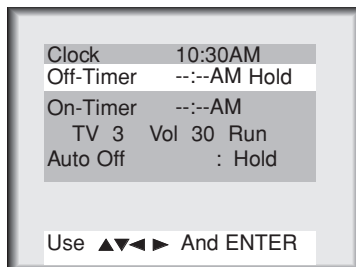

- 3 Press the volume (▶) button.

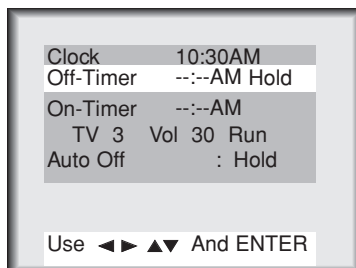

4 Press the channel (▲,▼) buttons to select hour you want to set.

- If you hold the ▲ button, the hour display is changed in the sequence of AM 1 → AM 2 → ...PM12 → PM 1 → AM 12, and changed in the reverse sequence for ▼ button.
- Select [PM 11].

5 Press the volume (▶) button.

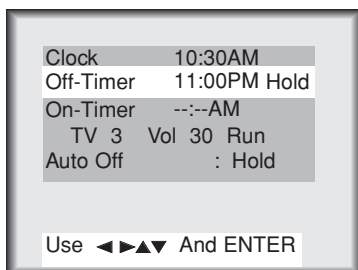

6 Press the channel (▲,▼) buttons to select minute you want to set.

- If you hold the ▲ button, the minute display is changed in the sequence of 00 → 01 → 02 ...58 → 59, and changed in the reverse sequence for ▼ button.
- Select [30].

7 Press the volume (▶) button to select [Hold] or [Run].

8 Press the channel (▲,▼) buttons to select [Run].

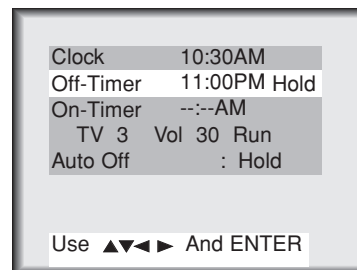

Press the **ENTER** button.

9

- Each press of channel (▲,▼) button changes the screen display as below.



- The screen display will disappear if you press the **ENTER** button once more.
- The screen display of [Sleep] appears on the screen for one minute until TV automatically turns off.

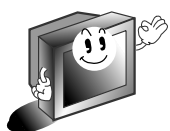

* When [Auto Off] is set to [RUN] with ▲▼◀▶ and **ENTER** buttons, the TV is switched to standby mode automatically in 10 minutes if there is no inpsignal.

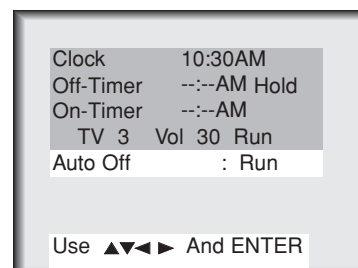

Setting On-Timer function

*Timer function can be operated only if current time has been already set.

Turning on at 7:10 AM with volume 40 on channel 8 by on-timer function

- 1 Press the **MENU** button to select the screen display as below.

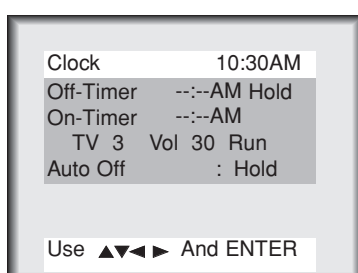

- 4 Press the channel (▲,▼) buttons to select hour you want.

- If you hold the ▲ button, the hour display is changed in the sequence of AM 1 → AM 2 → ...PM12 → PM 1 ... → AM 12, and changed in the reverse sequence for ▼ button.
- Select [AM 7].

- 2 Press the channel (▲,▼) buttons to select [On-Timer].

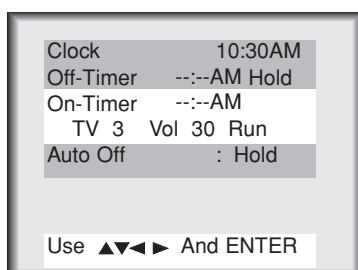

- 5 Press the volume (▶) button.

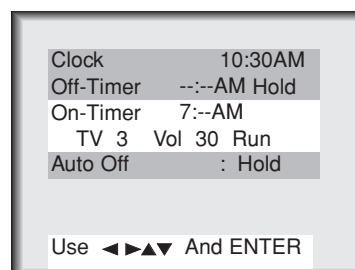

- 3 Press the volume (▶) button.

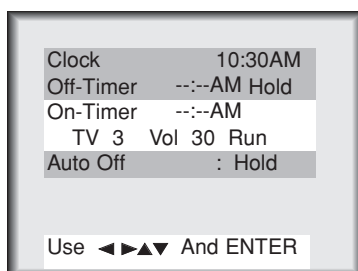

- 6 Press the channel (▲,▼) buttons to select minute you want.

- If you hold the ▲ button, the minute display is changed in the sequence of 00 → 01 → 02 ...58 → 59, and changed in the reverse sequence for ▼ button.
- Select [10].

7 Press the volume (▶) button.

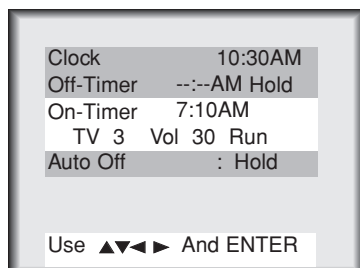

11 Press the volume (▶) button.

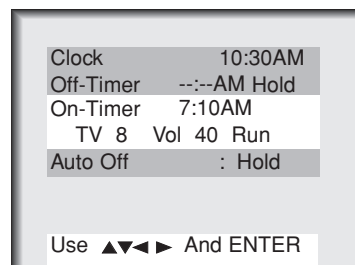

8 Press the channel (▲,▼) buttons to select the channel you want .

12 Press the channel (▲,▼) buttons to select [Run] and press the **ENTER** button.

9 Press the volume (▶) button.

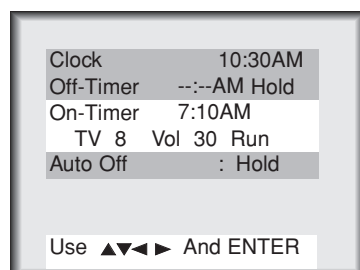

- Each press of volume (◀,▶) buttons changes the screen display as below.



- On-Timer function setting is completed.
- If you press the **ENTER** button once more, the screen display disappear and the set will be turned automatically on with volume level 40 on channel 8 at 7:10 AM.

10 Press the channel (▲,▼) buttons to select the volume you want .

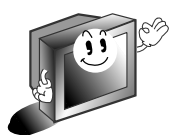

* If on-timer function is active, the current channel will change to the set channel when on-timer is activated.

* Unless any button is pressed within two hours after turning on the TV by on-timer function, the set is automatically turned off.

Setting sleep time function

* This function will automatically turn the set off after a set time.

1 Press the **SLEEP** button to set sleep time function.

- Each press of the button changes setting time status as below.

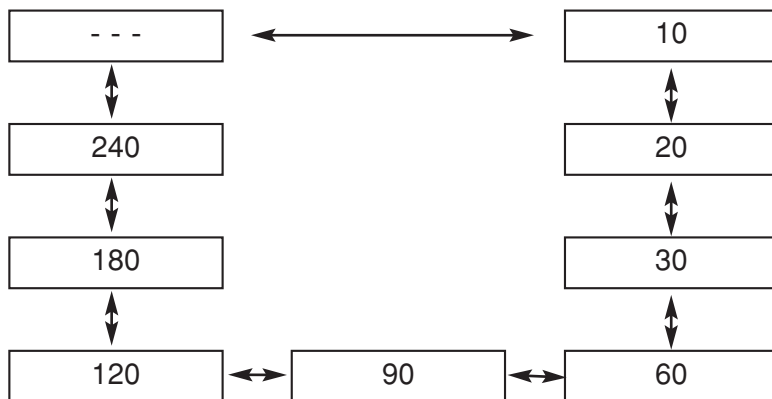
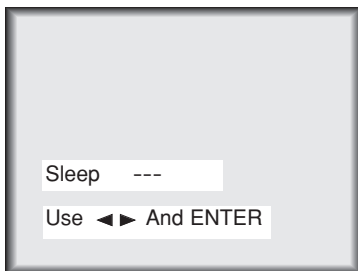

- To release sleep time setting, press the **SLEEP** button repeatedly to select [---].
- The screen display of [Sleep] appears on the screen for one minute until automatically turning off.

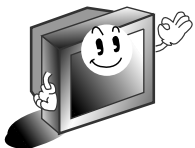

- * When a sleep time you want is displayed on the screen, don't press the **SLEEP** button. The screen display disappears and sleep time is to be set.
- * To check remaining sleep time after setting, press the **SLEEP** button just once.
- * To change sleep time setting, press the **SLEEP** button repeatedly to select time setting you want.
- * If you turn the set off after setting sleep time, the setting will be erased. Set it again.

Adjusting audio condition

Adjusting audio condition by user

1 Press the **MENU** button to select the screen display as below.

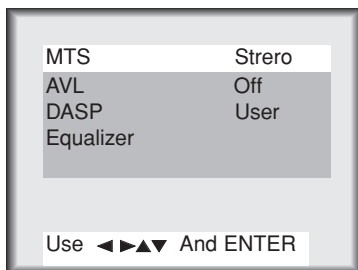

3 Press the volume (<left>, <right>) buttons to adjust the audio condition as you want.

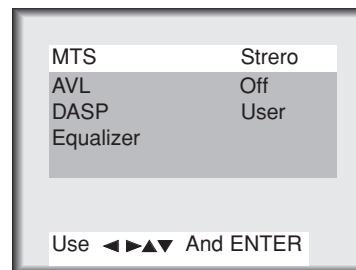

2 Press the channel (<up>,<down>) buttons to select a audio item you want to adjust.

4 Press the **ENTER** button.

MTS :

- Refer to page 42 for the details.

AVL (Auto Volume Level) :

- This function keeps the volume at the same level even when the channels are changed.

DASP (Digital Audio Signal Process) :

- This function makes it possible for the user to adjust the audio characteristics in each mode (Cinema, Music or Sports) just as he or she desires.

Equalizer :

- This function enables the user to make adjustments to the frequency bands listed below just as he or she desires.
100Hz, 500Hz, 1.5kHz, 5kHz, 10kHz.

Selecting bilingual signals

Screen display in stereo signal : Stereo
 Screen display in bilingual signal : SAP

* Bilingual (dual language) signal

- This signal contains the secondary language signal in addition to the primary language.
- There are the primary and secondary language and stereo modes in bilingual signal.
- [Mono] : The primary language is output from left and right speaker. Signal mode is mono.
- [Stereo] : The primary language is output from left and right speaker. Signal mode is stereo.
- [SAP] : The secondary language is output from left and right speaker.

1 Press the **MENU** button to select the screen display as below.

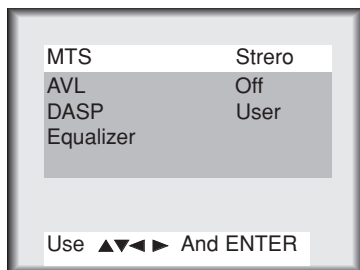

3 Press the volume (◀, ▶) buttons to select an audio mode you want.

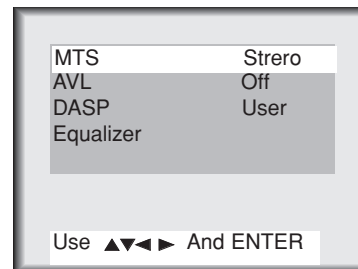

- Each press of volume (◀, ▶) buttons changes the screen display as below.

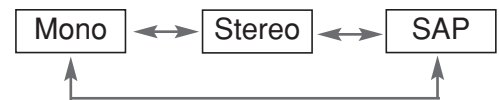

2 Press the channel (▲,▼) buttons to select [MTS].

4 Press the **ENTER** button.

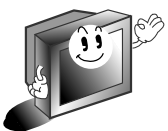

* If some strange sound is heard when watching TV programs on stereo mode in poor signal areas, or if in non-dual signal service area, make sure to select mono mode.

* [Stereo] or [Mono] mode can be available only when broadcasting signal contains the data.

Mute

* This function cuts off speaker sound. It's convenient when getting phone calls.

1 Press the **MUTE** button.

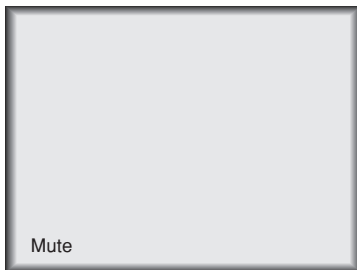

- To release muted sound, press the **MUTE** button or volume (◀, ▶) buttons.
- If muted sound is released, volume level is displayed on the screen.

Using headphone

- Headphone is an optional item.
- You can adjust headphone sound with volume(◀, ▶) buttons. While you are listening to sound through headphone, speaker sound is cut off.

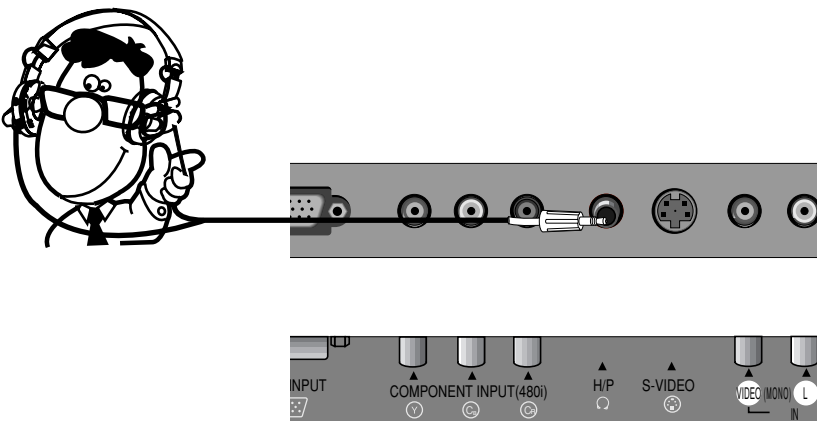

Adjusting video condition

APC (Auto Picture Control)

- 1 Press the **MENU** button to select the screen display as below.

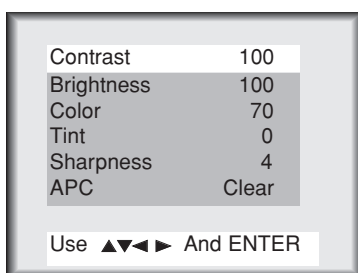

- 2 Press the channel (▲,▼) buttons to select [APC].

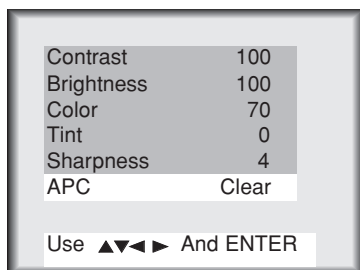

- Each press of volume (◀, ▶) buttons changes the screen display as below.

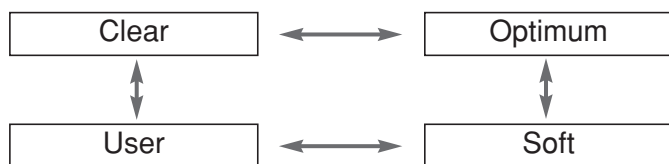

- 3 Press the **ENTER** button.



Manual picture control

- 1** Press the **MENU** button to select the screen display as below.

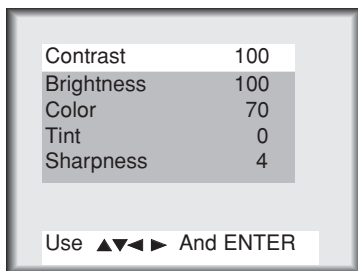

- 3** Press the volume (◀, ▶) buttons to adjust the picture condition as you want.

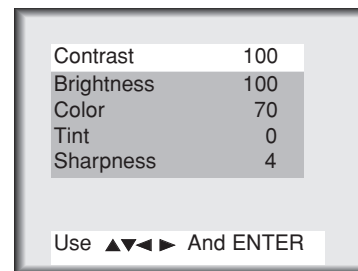

- [Contrast], [Brightness], [Color] are adjusted from 0 to 100.
- [Tint] is adjusted from Red 50 to Green 50.
- [Sharpness] is adjusted from 0 to 10.

- 2** Press the channel (▲, ▼) buttons to select a picture item you want to adjust.

Contrast :

- Adjust the different between the light and dark levels of the picture..

Brightness :

- Adjust the white or light of the overall picture..

Sharpness:

- Adjust the levels of crispness in the edges between the light and dark area of the picture. The lower the level, the softer the image.

Color:

- Adjust the richness of all colors.

- 4** Press the **ENTER** button.

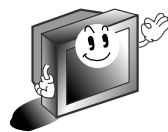

* APC setting is to be released if you use this function.

Fine:

- This function is to adjust the picture to stable condition when it is poor, for example, a horizontal stripe, twisted picture or no color in broadcasting.

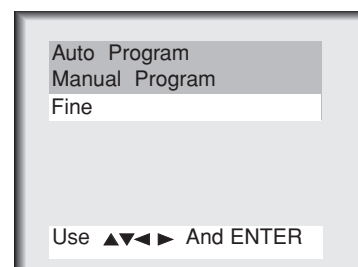

Product specifications

Model	:	LC1500
Main body	:	Horizontal size (mm) : 394 Height (mm) : 384 Thickness (mm) : 105.5 Weight (kg) : 5.2
Including table stand	:	Horizontal size (mm) : 394 Height (mm) : 413 Thickness (mm) : 194 Weight (kg) : 7.9
Power requirements	:	DC 12V/3A
		* CAUTION : For use only with Model No. CAM-1230 AC Adaptor, manufactured by Chang-Nam Electronics.
Television system	:	NTSC
Television channels	:	VHF : 2 ~ 13, UHF : 14 ~ 69 Cable : 01 ~ 125
Tube	:	LCD Panel
Power consumption	:	See the back of the set
External antenna impedance	:	75 Ω
Audio output	:	1.0W + 1.0W
Speaker outputs	:	8 Ω X 2
External input ports	:	VIDEO input port set 1 S-VIDEO input 1 Headphone jack 1 PC/D-TV input 1 Component video input set 1 Power input 1 Antenna input 1
Adaptor (DC power)	:	In : AC 100-240V ~ 1.3A-0.7A 50/60Hz, 85VA Out : DC 12V, 3A
		* CAUTION : For use only with Model No. CAM-1230 AC Adaptor, manufactured by Chang-Nam Electronics.
Power supply cordset	:	Standard North America three wire earth-grounding with flexible cord SJT type or higher type.
		* CAUTION : If replacement becomes necessary, replace it with an exact duplicate. Contact any MARANTZ authorized service center.

Memo

COUNTRY	COMPANY	ADDRESS
ALGERIE	Azur 2000	8, Lotissement Ben Hatadi, Alger, Algerie
ARMENIA	NGYIG Ltd.	47 A/75 St. Lalaiaants, 375000 Yerevan, Armenia
AUSTRALIA	Jamo Australia Pty. Ltd.,	24 Lionel Road, Mt. Waverley, VIC 3149, Australia
AUSTRIA	Huber & Prohaska GmbH	Taborstraße 95 / Ladestraße 1, Gebäude Hangartner, A-1200 Wien, Austria
BAHREIN	Ambassador Stores	P.O. Box 237,141, Government Avenue, Manama,Bahrein
BANGLADESH	Target	1078, Ramjoy Mohanja Lane Asadgonj, Chittagong 4000, Bangladesh
BELGIUM	Van der Heyden Audio N.V.	Brusselbaan 278, 9320 Erembodegem, Belgium
BULGARIA	Ariescommerce GmbH	Makedonia Blvd. 16, 1606 Sofia, Bulgaria
CANADA	Lenbrook Industries Limited	633 Granite Court, Pickering, Ontario
CHINA	Guang Chang Audio International Co., Ltd.	No.38 Yushan Road, ShiQiao, Pan Yu, Guang Dong, China
CYPRUS	Empire Hifi systems Ltd.	P.O. Box 5604, Nicosia, Cyprus
CZECH REPUBLIC	Audio International	Sokolska 41, 67902 Rajecsko, OKR,Blansko, Czech Republic
DENMARK	Audio Nord	Dali Allé 1, 9610 Noerager, Denmark
DUBAI	V.V.& SONS	P.O. Box 105, Dubai, U.A.E.
EGYPT	Solimco	9, El Attibaa St. Doki, Cairo, Egypt
ESTONIA	HiFi Club Estonia	Ehte 4, 90503 Haapsalu, Estonia
F.Y.R.O.M.	T.P. KODI	ul.Cedomir Kantargiev 21a, Skopje, Former Yugoslavian Republic of Macedonia
FINLAND	Audio Nord	Uudenmaankatu 4-6, Helsinki SF-00120, Finland
FRANCE	Marantz France	A division of Marantz Europe B.V., P.O. Box 301, 92 156 Suresnes Cedex, France
GERMANY	Marantz Deutschland	Hakenbusch 3, 49078 Osnabrück, Germany
GREECE	Adamco S.A.	188, Hippocratous Street, 11471 Athens, Greece
HEADQUARTERS EUROPE:	Marantz Europe B.V.	Building SFF-2, P.O. Box 80002, 5600 JB Eindhoven, The Netherlands
HONG KONG	Marantz Asia Ltd.	Unit 1706, Metroplaza II, 223 Hing Fong Road, Kwai Fong, N.T., Kowloon, Hong Kong
HUNGARY	Infovox Ltd.	Terez Krt.31, 1067 Budapest, Hungary
ICELAND	ID Electronics Ltd.	Armula 38, 108 Reykjavik, Iceland
INDIA	NOVA Audio Private	8,Punam Co-op.Society 29/30 Road#5, Union Park MUMBAI 400052, India
IRAN	Home Co.	5th floor no 878 Philips Building Enghelab ave, P.O. 11365/7844 Tehran, Iran
IRELAND	Marantz Ireland	Clonskeagh, Dublin 14, Ireland
ISRAEL	Elmor Ltd.	52 Heh Beiyar Street, Kikar Hamedina, Tel Aviv, Israel
ITALY	Marantz Italy	Via Casati 23, 20052 Monza (Milano), Italy, Servizio Consumatori 1678-20026, Numero Verde
IVORY COAST	Hifivoir	B.P. 2428, Abidjan 01, Ivory Coast
JAPAN	Marantz Japan Inc.	35-1 Sagami Ohno 7-Chome, Sagamihara-shi, Kanagawa 228-8505, Japan
KOREA	Mk Enterprises Ltd.	121-210, 2F Shinhan Bldg., 247-17 Seokyo-dong, Mapo-ku, Seoul, Korea
KUWAIT	alAlamiah Electronics Intl.	P.O. Box 8196, Salmiah 22052, Kuwait
LATVIA	Ace Ltd.	61, LacPlesa Str., Riga LV 1011, Latvia
LEBANON	AZ Electronics S.A., 1,	P.O. Box 11 2833, Beirut, Lebanon
LITHUANIA	Accapella Ltd.	Ausros, Vartu G/5, Pasazo SKG., 2001 Vilnius, Lithuania
MALAYSIA	Wo Kee Hong Electronics Sdn. Bhd.	Suite 8.1, Level 8, Menara Genesis, No. 33, Jalan Sultan Ismail, 50250 Kuala Lumpur, Malaysia
MALTA	Doneo Co Ltd.	78 The Strand, Sliema SLM07, Malta
MAURITIUS	SKR Electronics Ltd.	P.O. Box 685, Bell Village, Port Louis, Mauritius
MILITARY MARKET EUROPE	PASCO GmbH	PO BOX 1280, Sandhausen 69200, Germany
NETHERLANDS	Marantz Domestic Sales	A division of Marantz Europe B.V., Building SFF2, P.O. Box 80002, 5600 JB Eindhoven, The Netherlands
NEW ZEALAND	Wildash Audio Systems	14 Malvern Road, Mt. Albert, Auckland, New Zealand
NORWAY	Audio Nord	Sandkerveien 64, Oslo 0483, Norway
OMAN	Mustafa & Jawad Trading CO.	P.O. Box 1918, Ruwi, Oman
POLAND	Philips Polska Sp. z.o.o.	Al.Jerozolimskie 195b, 02 222 Warszawa, Poland
PORTUGAL	Corel2	Comércio de Electrónica Lda., Av. Luís Bivar, No 85 A, 1050 Lisboa, Portugal
PROFESSIONAL EUROPE	Marantz Professional Products	Kingsbridge House, Padbury Oaks, 575-583 Bath Road, Longford, Middlesex UB7 0EH, U.K.
PROFESSIONAL U.S.A.	Marantz Professional Products	Distributed by: Superscope Technologies Inc., 1000 Corporate Blvd. Ste.D, Aurora, IL
QATAR	Almana & Partners W.W.L.	P.O. Box 49, Doha, Qatar
REUNION	Vision +	180 Rue du Marechal Leclerc, 97400 Saint Denis, Ile de la Reunion
ROMANIA	Nova Music Entertainment	5, Zagazului Str. Bl.1G,apt.18, sector 1,Bucharest, Romania
RUSSIA	Absolute Audio	7/2, Montazhnaya Street, 107497 Moscow, Russia
SAUDI ARABIA	Adawlia Univ. Electr. Apl	P.O. Box 2154, Alkhobar 31952, Saudi Arabia
SINGAPORE	Wo Kee Hong Distribution PTE Ltd.	130 Joo Seng Road, #03-02 Olivine Building, Singapore 368357
SLOVAKIA	Bis Audio s.r.o.	Nam. SNP 10, 96001 Zvolem, Slovakia
SLOVENIA	Bofex	Smartinska 152, HALA V/3, 61000 Ljubljana, Slovenia
SOUTH AFRICA	Coherent Imports (PTY) Ltd.	P.O. Box 1614, Alberton, 1450, South Africa
SPAIN	Marantz Spain	Martinez Villergas 2, Apartado 2065, Madrid 28027, Spain
SRI LANKA	The listening Room	Mezzanine Floor, The Landmark 385, Galle Road, Colombo - 3, Sri Lanka
SWEDEN	Audio Nord	Almedalsvagen 4, Gotenborg 402-23, Sweden
SWITZERLAND	Sound Company AG	Postfach, 8010 Zürich, Switzerland
SYRIA	Hamzeh & Partners	Hafez Ibrahim Str. No 117, Damascus Shalan, Syria
TAHITI	Covecolor	Av. Prince Hinoi, Cours de l'union sacré, P.O. Box 2334, Papeete, Tahiti
TAIWAN	Pai-Yuing Co. Ltd.	6th No 148 Sung Kiang Road, Taipei 10429, Taiwan R.O.C.
THAILAND	MRZ Standard Co. Ltd.	746-750 Mahachai Road, Wangburapa, Bangkok 10200, Thailand
TUNESIA	Societe EDEVIG	40, Avenue du Golfe Arabe, El Menzah, 1004, Tunesia
TURKEY	Türk Philips Ticaret A.S.	Yukari Dudullu Organize sanayi Bolgesi, 2.Cadde no.28, 81260 Umraniye-Istanbul, Turkey
U.K.	Marantz Hifi UK Ltd.	Kingsbridge House, Padbury Oaks, 575-583 Bath Road, Longford, Middlesex UB7 0EH, U.K.
U.S.A.	Marantz America Inc.	1100 Maplewood Drive Itasca, IL 60143, U.S.A.
YUGOSLAVIA	ITM Company	Omladinskih Brigada 86, 11070 Belgrade, Yugoslavia
EXPORT	Marantz Domestic Sales	A division of Marantz Europe BV,Building SFF2, P.O. Box 80002, 5600 JB Eindhoven, TheThe Netherlands

www.marantz.com

marantz® is a registered trademark.

