

HP LE1901wi, L1910i, and LE1911i LCD
Monitors
User Guide



© 2007, 2008, 2009 Hewlett-Packard
Development Company, L.P.

Microsoft, Windows, and Windows Vista are either trademarks or registered trademarks of Microsoft Corporation in the United States and/or other countries.

The only warranties for HP products and services are set forth in the express warranty statements accompanying such products and services. Nothing herein should be construed as constituting an additional warranty. HP shall not be liable for technical or editorial errors or omissions contained herein.

This document contains proprietary information that is protected by copyright. No part of this document may be photocopied, reproduced, or translated to another language without the prior written consent of Hewlett-Packard Company.

Sixth Edition (July 2009)

Document Part Number: 448556-006

About This Guide

This guide provides information on setting up the monitor, installing drivers, using the on-screen display menu, troubleshooting and technical specifications.



-  **WARNING!** Text set off in this manner indicates that failure to follow directions could result in bodily harm or loss of life.
-  **CAUTION:** Text set off in this manner indicates that failure to follow directions could result in damage to equipment or loss of information.
-  **NOTE:** Text set off in this manner provides important supplemental information.

Table of contents

1 Product Features

HP LCD Monitors with Integrated Work Center	1
---	---

2 Safety and Maintenance Guidelines

Important Safety Information	3
Maintenance Guidelines	3
Cleaning the Monitor	4
Shipping the Monitor	4

3 Setting Up the Monitor

Installing the Monitor on the Stand	5
Installing an HP Ultra-slim Desktop (USDT) on the Stand	7
Installing an HP Thin Client on the Stand	11
Adjusting the Monitor	15
Turning on the Monitor	16
Removing the Computer from the Stand	17
Removing the Monitor from the Stand	18
Monitor Mounting Alternatives	18
Locating the Rating Labels	19

4 Operating the Monitor

Software and Utilities	20
The Information File	20
The Image Color Matching File	20
Installing the .INF and .ICM Files	21
Installing from the CD	21
Downloading from the Worldwide Web	21
Front Panel Controls	22
Adjusting the Monitor Settings	22
Using the On-Screen Display Menu	22
OSD Menu Selections	23
Adjusting Screen Quality	26
Optimizing Digital Conversion	26

Using the HP Display Assistant Utility	27
Identifying Monitor Conditions	27
Sleep Timer Mode	28
HP Display LiteSaver	29
Installing the HP Display LiteSaver Software	29
sRGB Support	30
Changing the Color Temperature	30
Installing the sRGB ICM File for Microsoft Windows 2000 and Windows XP	30
Installing the sRGB ICM File for Microsoft Windows Vista	31

Appendix A Troubleshooting

Solving Common Problems	32
Online Technical Support	34
Preparing to Call Technical Support	34

Appendix B Technical Specifications

LE1901wi Model	35
L1910i Model	36
LE1911i Model	37
Recognizing Preset Display Resolutions	38
LE1901wi Model	38
L1910i Model	38
LE1911i Model	39
Entering User Modes	39
Energy Saver Feature	39

Appendix C Agency Regulatory Notices

Federal Communications Commission Notice	41
Modifications	41
Cables	41
Declaration of Conformity for Products Marked with the FCC Logo (United States Only)	41
Canadian Notice	42
Avis Canadien	42
European Union Regulatory Notice	42
German Ergonomics Notice	43
Japanese Notice	43
Korean Notice	43
Power Cord Set Requirements	43
Japanese Power Cord Requirements	43
Product Environmental Notices	44
ENERGY STAR® Qualification	44
Materials Disposal	44

Disposal of Waste Equipment by Users in Private Household in the European Union 45
HP Recycling Program 45
Chemical Substances 45
Restriction of Hazardous Substances (RoHS) 45
Turkey EEE Regulation 46

Appendix D LCD Monitor Quality and Pixel Policy

1 Product Features

HP LCD Monitors with Integrated Work Center

The flat panel monitors have an active matrix, thin-film transistor (TFT), liquid crystal display (LCD). The monitor models include:

- LE1901wi model, 48.2 cm (19-inch) diagonal viewable area with 1440 x 900 resolution, plus full-screen support for lower resolutions; includes custom scaling for maximum image size while persevering original aspect ratio
- L1910i model, 48.3 cm (19-inch) diagonal viewable area display with 1280 × 1024 resolution, plus full-screen support for lower resolutions
- LE1911i model, 48.3 cm (19-inch) diagonal viewable area display with 1280 x 1024 resolution, plus full-screen support for lower resolutions
- Wide viewing angle to allow viewing from a sitting or standing position, or moving side-to-side
- Tilt, swivel, and height adjustment capabilities
- Integrated Work Center stand that integrates the monitor with an HP Ultra-slim Desktop (USDT) PC or Thin Client on a single stand for the convenience of an "all-in-one" form factor
- HP Quick Release for flexible and easy monitor panel removal and mounting solutions
- Power cable and VGA signal cable included
- Accepts an optional mounted HP speaker bar
- Plug and play capability if supported by the system
- On-Screen Display (OSD) adjustments in several languages for easy setup and screen optimization
- Software and documentation CD that includes software, monitor drivers, an information file (INF), Image Color Matching file (ICM), and product documentation
- Energy Saver feature to meet requirements for reduced power consumption
- Energy Star qualified

- AssetControl (available with select models)
- Compliant with the following regulated specifications:
 - European Union CE Directives
 - Swedish MPR II 1990
 - Swedish TCO Requirements

2 Safety and Maintenance Guidelines

Important Safety Information

A power cord is included with the monitor. If another cord is used, use only a power source and connection appropriate for this monitor. For information on the correct power cord set to use with the monitor, refer to [Power Cord Set Requirements on page 43](#) in Appendix C.

△ **WARNING!** To reduce the risk of electric shock or damage to the equipment:

- Do not disable the power cord grounding feature. The grounding plug is an important safety feature.
- Plug the power cord into a grounded (earthed) electrical outlet that is easily accessible at all times.
- Disconnect power from the product by unplugging the power cord from the electrical outlet.

For your safety, do not place anything on power cords or cables. Arrange them so that no one may accidentally step on or trip over them. Do not pull on a cord or cable. When unplugging from the electrical outlet, grasp the cord by the plug.

To reduce the risk of serious injury, read the *Safety and Comfort Guide*. It describes proper workstation, setup, posture, and health and work habits for computer users, and provides important electrical and mechanical safety information. This guide is located on the Web at <http://www.hp.com/ergo> and/or on the documentation CD, if one is included with the monitor.

△ **CAUTION:** For the protection of the monitor, as well as the computer, connect all power cords for the computer and its peripheral devices (such as a monitor, printer, scanner) to some form of surge protection device such as a power strip or Uninterruptible Power Supply (UPS). Not all power strips provide surge protection; the power strips must be specifically labeled as having this ability. Use a power strip whose manufacturer offers a Damage Replacement Policy so you can replace the equipment, if surge protection fails.

Maintenance Guidelines

To enhance the performance and extend the life of the monitor:

- Do not open the monitor cabinet or attempt to service this product yourself. Adjust only those controls that are covered in the operating instructions. If the monitor is not operating properly or has been dropped or damaged, contact an authorized HP dealer, reseller, or service provider.
- Use only a power source and connection appropriate for this monitor, as indicated on the label/back plate of the monitor.
- Be sure the total ampere rating of the products connected to the outlet does not exceed the current rating of the electrical outlet, and the total ampere rating of the products connected to the cord does

not exceed the rating of the cord. Look on the power label to determine the ampere rating (AMPS or A) for each device.

- Install the monitor near an outlet that you can easily reach. Disconnect the monitor by grasping the plug firmly and pulling it from the outlet. Never disconnect the monitor by pulling the cord.
- Turn the monitor off when not in use. You can substantially increase the life expectancy of the monitor by using a screen saver program and turning off the monitor when not in use.

 **NOTE:** Monitors with a “burned-in image” are not covered under the HP warranty.

- Slots and openings in the cabinet are provided for ventilation. These openings must not be blocked or covered. Never push objects of any kind into cabinet slots or other openings.
- Do not drop the monitor or place it on an unstable surface.
- Do not allow anything to rest on the power cord. Do not walk on the cord.
- Keep the monitor in a well-ventilated area, away from excessive light, heat or moisture.

Cleaning the Monitor

1. Turn off the monitor and unplug the power cord from the back of the unit.
2. Dust the monitor by wiping the screen and the cabinet with a soft, clean antistatic cloth.
3. For more difficult cleaning situations, use a 50/50 mix of water and Isopropyl alcohol.

 **CAUTION:** Spray the cleaner onto a cloth and use the damp cloth to gently wipe the screen surface. Never spray the cleaner directly on the screen surface. It may run behind the bezel and damage the electronics.

CAUTION: Do not use cleaners that contain any petroleum based materials such as benzene, thinner, or any volatile substance to clean the monitor screen or cabinet. These chemicals may damage the monitor.

Shipping the Monitor

Keep the original packing box in a storage area. You may need it later if you move or ship the monitor.

3 Setting Up the Monitor

To set up the monitor, ensure that the power is turned off to the monitor, computer system, and other attached devices, then follow the instructions below.

Installing the Monitor on the Stand

△ **CAUTION:** Do not touch the surface of the LCD panel. Pressure on the panel may cause non-uniformity of color or disorientation of the liquid crystals. If this occurs the screen will not recover to its normal condition.

1. Place the monitor panel face down on a dry, soft cloth and connect the VGA cable and power cable to the monitor.

Figure 3-1 Connecting VGA and Power Cables to the Monitor

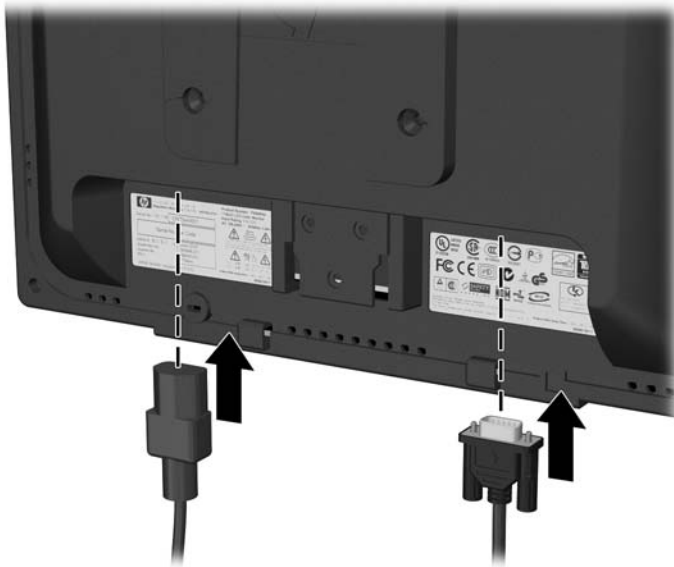

2. Place the stand on a desktop or table and push the neck on the stand down to its lowest position. Slide the monitor all the way onto the stand so that the Quick Release mounting device emits an audible click and is locked in place.

Figure 3-2 Installing the Monitor on the Stand



3. Route the monitor VGA and power cables through the cable guides at the bottom corners of the mounting panel (select models).

Figure 3-3 Routing Monitor VGA and Power Cables

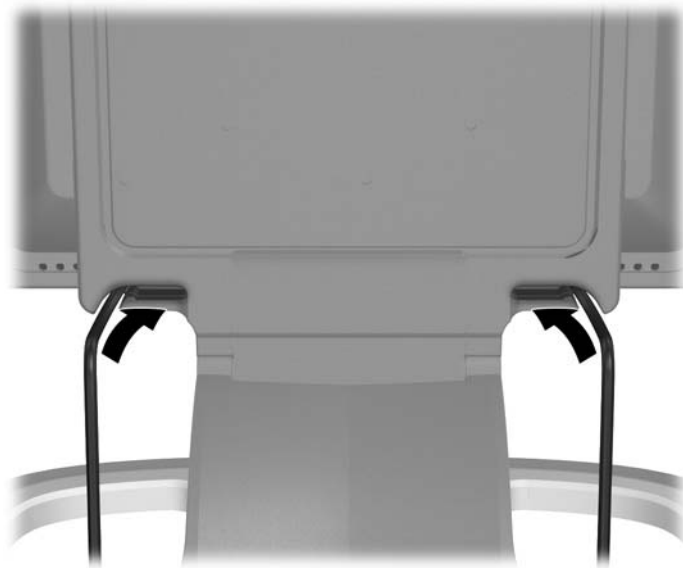

4. To install an HP USDT computer on the rear of the stand, follow the procedure in [Installing an HP Ultra-slim Desktop \(USDT\) on the Stand on page 7](#). To install an HP Thin Client computer on the rear of the stand, follow the procedure in [Installing an HP Thin Client on the Stand on page 11](#).

Installing an HP Ultra-slim Desktop (USDT) on the Stand

You can install an HP USDT or Thin Client computer on the rear side of the stand. This section provides instructions on installing the USDT.

1. On the rear of the stand, remove the two screws (1) from the top of the computer mounting bracket and lift the bracket off the stand (2).

Figure 3-4 Removing the Computer Mounting Bracket

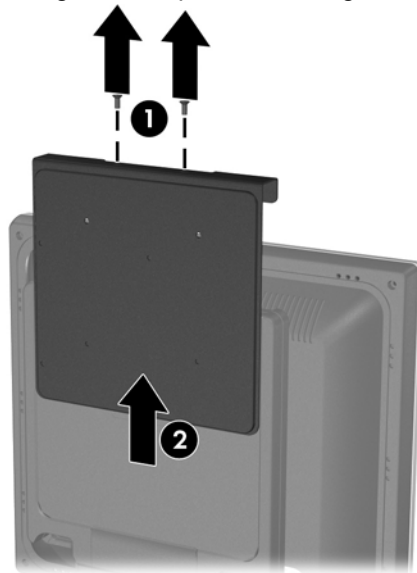

2. Use the four screws provided to install the computer mounting bracket on the USDT computer.

 **NOTE:** There are two sets of screw holes on the computer mounting bracket. Use the four holes that are offset to install the USDT.

Be sure to install the computer mounting bracket on the USDT so that the rear ports on the USDT are toward the right when viewed from the rear of the monitor stand. (The rear ports should be toward the left when viewed from the front of the monitor.)

Figure 3-5 Installing the Computer Mounting Bracket on the USDT

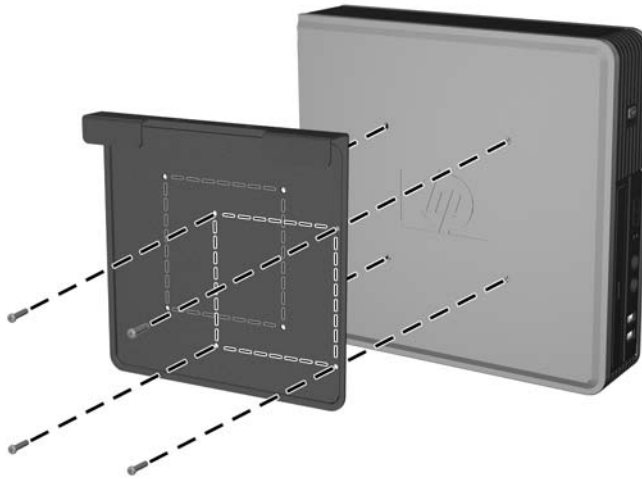

3. Slide the computer mounting bracket/USDT computer onto the stand (1) and reinstall the two screws on top of the bracket (2).

Figure 3-6 Sliding the USDT onto the Stand

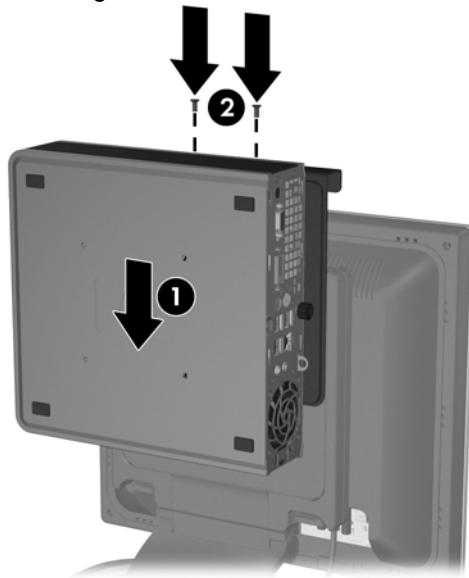

4. Thread the VGA cable from the monitor, along with the circular end of the computer power cable and any other cables that will connect to the rear of the computer (such as keyboard and mouse

- cables), up through the bottom hole of the USDT computer's port cover (1) and then connect the cables to the rear of the computer (2).
5. Plug the computer and monitor power cables into an electrical wall outlet (3).

Figure 3-7 Connecting the Cables

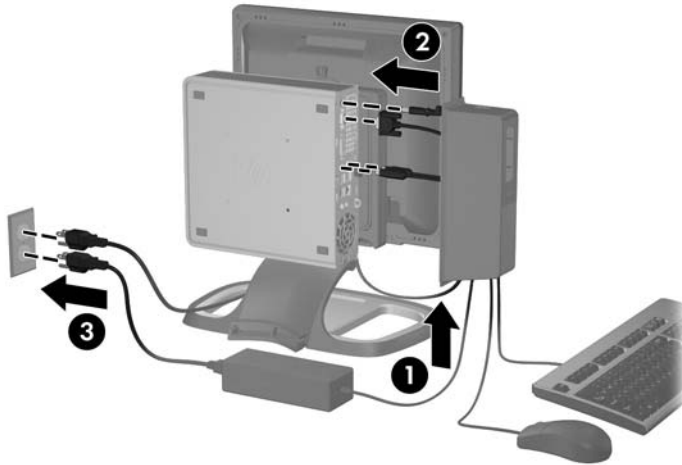

6. Insert the hooks on the port cover into the slots on the rear of the USDT chassis and slide the port cover down so that it locks in place.

Figure 3-8 Installing the Port Cover

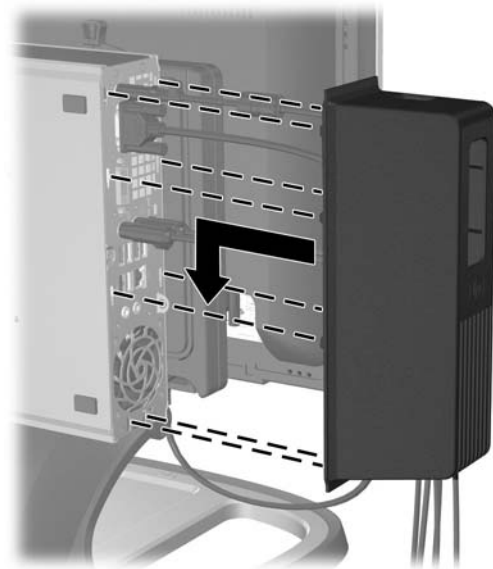

7. Slide the power supply tray out from the base of the stand (1) and place the USDT power supply into the tray (2). Route any loose cables through the cables guides on the sides of the tray (3).

Figure 3-9 Installing the Power Supply

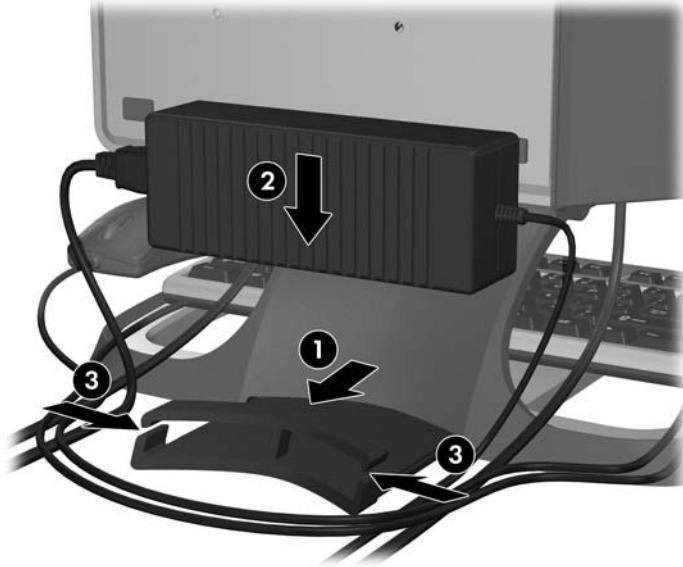

8. Be sure the final configuration has the USDT properly oriented, as shown in the illustration below.

Figure 3-10 Proper Assembly of Integrated Work Center



⚠ WARNING! To reduce the risk of electric shock or damage to the equipment:

- Do not disable the power cord grounding plug. The grounding plug is an important safety feature.
- Plug the power cord into a grounded (earthed) electrical outlet that is easily accessible at all times.
- Disconnect power from the equipment by unplugging the power cord from the electrical outlet.

For your safety, do not place anything on power cords or cables. Arrange them so that no one may accidentally step on or trip over them. Do not pull on a cord or cable. When unplugging from the electrical outlet, grasp the cord by the plug.

Installing an HP Thin Client on the Stand

You can install an HP USDT or Thin Client computer on the rear side of the stand. This section provides instructions on installing the Thin Client.

1. On the rear of the stand, remove the two screws (1) from the top of the computer mounting bracket and lift the bracket off the stand (2).

Figure 3-11 Removing the Computer Mounting Bracket

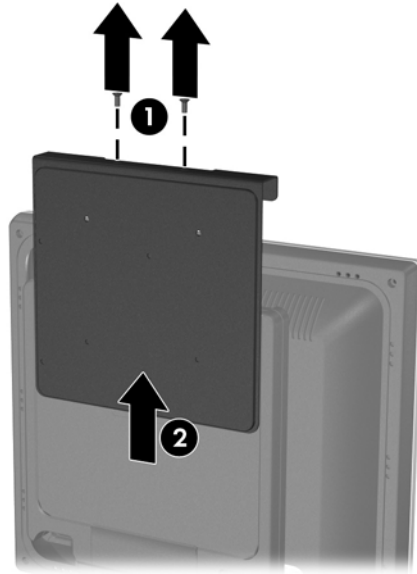

2. Remove the HP logo panel from the right side of the Thin Client to access the screw holes for the computer mounting bracket.

Figure 3-12 Removing the HP Logo Panel

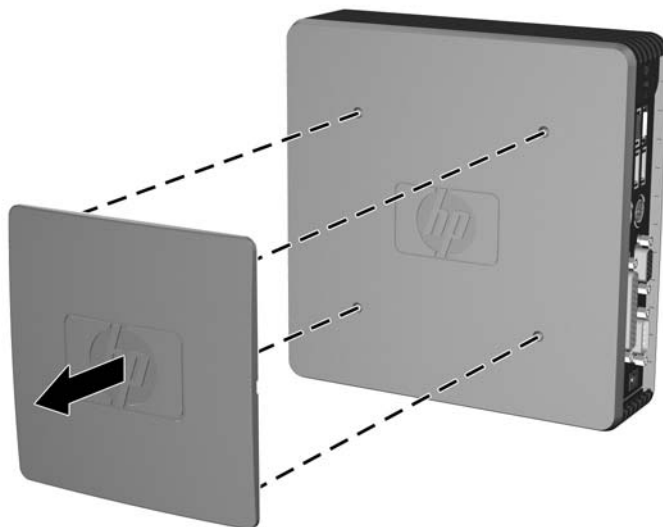

3. Use the four screws provided to install the computer mounting bracket on the Thin Client computer.

 **NOTE:** There are two sets of screw holes on the computer mounting bracket. Use the four holes that are centered on the bracket to install the Thin Client.

Be sure to install the computer mounting bracket on the Thin Client so that the rear ports on the Thin Client are facing down and the feet on the Thin Client are facing outwards.

Figure 3-13 Installing the Computer Mounting Bracket on the Thin Client

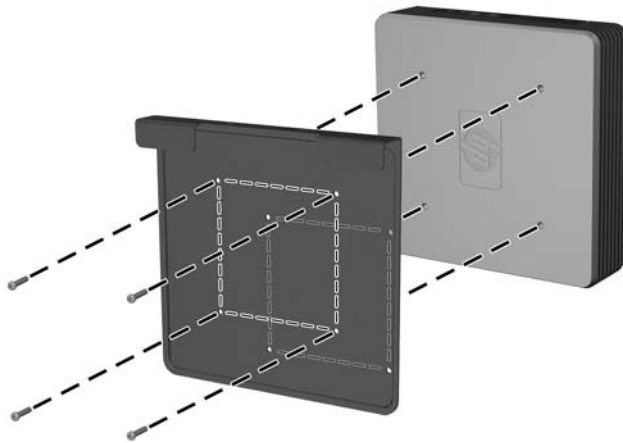

4. Slide the computer mounting bracket/Thin Client computer onto the stand (1) and reinstall the two screws on top of the bracket (2).

Figure 3-14 Sliding the Thin Client onto the Stand

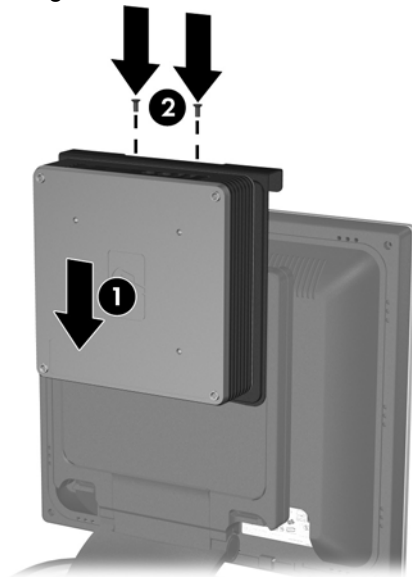

5. Connect the Thin Client power cable and peripheral device cables, such as keyboard and mouse cables, to the rear of the computer (1), then plug the computer and monitor power cables into an electrical wall outlet (2).

Figure 3-15 Connecting the Cables

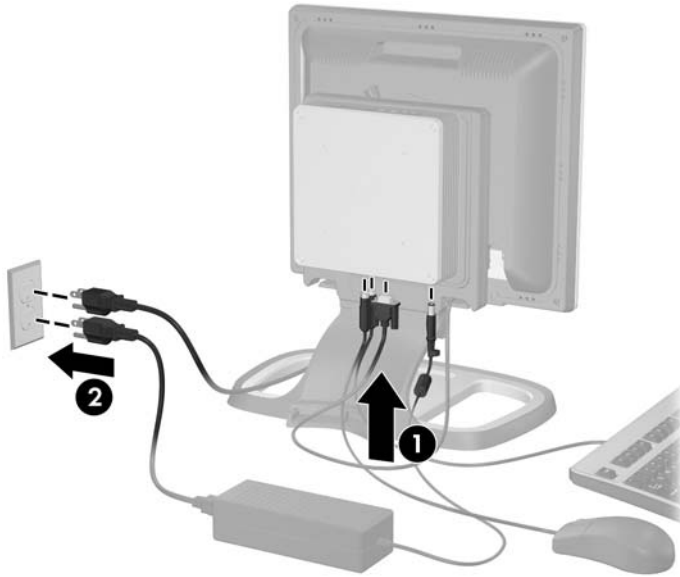

6. Slide the power supply tray out from the base of the stand (1) and place the Thin Client power supply into the tray (2). Route any loose cables through the cables guides on the sides of the tray (3).

Figure 3-16 Installing the Power Supply

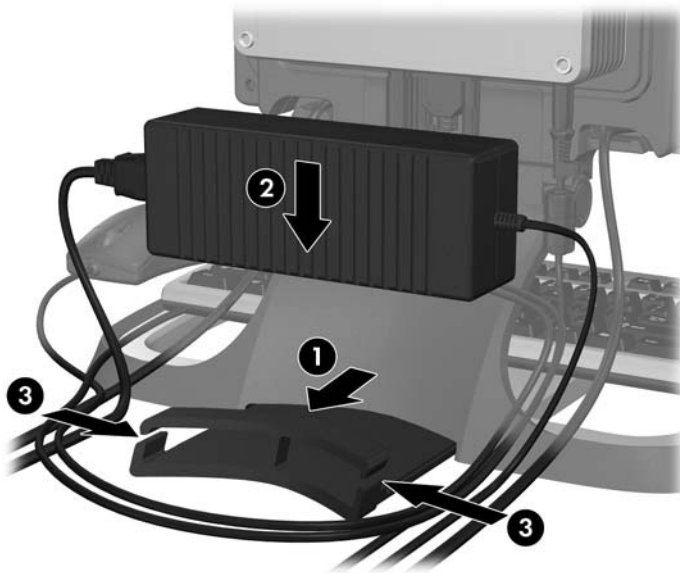

7. Be sure the final configuration has the Thin Client properly oriented, as shown in the illustration below.

Figure 3-17 Proper Assembly of Integrated Work Center



⚠ WARNING! To reduce the risk of electric shock or damage to the equipment:

- Do not disable the power cord grounding plug. The grounding plug is an important safety feature.
- Plug the power cord into a grounded (earthed) electrical outlet that is easily accessible at all times.
- Disconnect power from the equipment by unplugging the power cord from the electrical outlet.

For your safety, do not place anything on power cords or cables. Arrange them so that no one may accidentally step on or trip over them. Do not pull on a cord or cable. When unplugging from the electrical outlet, grasp the cord by the plug.

Adjusting the Monitor

 **NOTE:** Your monitor model may look different than the model in the following illustrations.

1. Tilt the monitor's panel forward or backward to set it to a comfortable eye level.

Figure 3-18 Tilting the Monitor

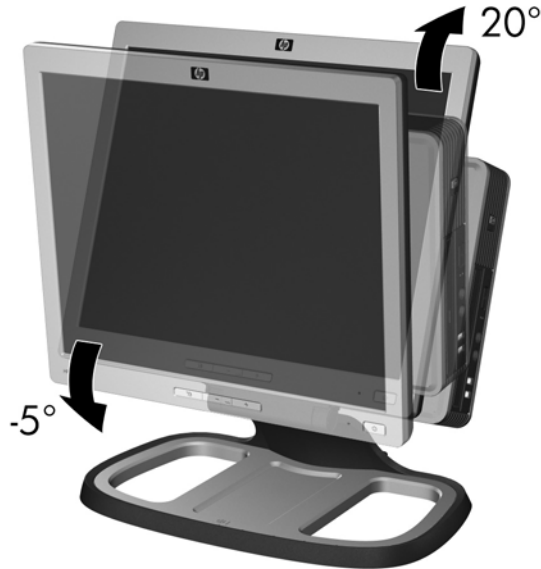

2. Swivel the monitor base to the left or right for the best viewing angle.

Figure 3-19 Swiveling the Monitor



3. Adjust the monitor's height so that it is parallel to your eye height for a comfortable viewing position.

△ **CAUTION:** To prevent damage to the monitor, be sure not to lower it onto objects in the tray at the base of the stand.

If an optional speaker bar is installed, exercise caution when moving the display head to the lower end of the height-adjustment range. Contact with the stand could result in scratched paint or other cosmetic damage to either the stand or the speaker bar.

Figure 3-20 Adjusting the Height



Turning on the Monitor

1. Press the power button on the computer to turn it on.
2. Press the power button on the front of the monitor to turn it on.

△ **CAUTION:** Burn-in image damage may occur on monitors that display the same static image on screen for a prolonged period of time.* To avoid burn-in image damage on the monitor screen, you should always activate a screen saver application or turn off the monitor when it is not in use for a prolonged period of time. Image retention is a condition that may occur on all LCD screens. Monitors with a “burned-in image” are not covered under the HP warranty.

* A prolonged period of time is 12 consecutive hours of non-use.

📄 **NOTE:** On some models, if pressing the monitor power button has no effect, the Power Button Lockout feature may be enabled. To disable the feature, press and hold the monitor power button for 10 seconds.

Removing the Computer from the Stand

△ **CAUTION:** Before beginning to disassemble the computer, be sure the computer is turned off and all cables are disconnected.

1. Turn off power to the computer and unplug the power cable from the electrical wall outlet.
2. On the USDT assembled integrated work center, remove the port cover by pulling back the retention lever inside the bottom port cover opening then slide the cover up and off the computer.
3. Disconnect all the cables from the rear of the computer.
4. Remove the two screws from the top of the computer mounting bracket (1) and slide the computer up and off the stand (2).

Figure 3-21 Removing the Computer from the Stand (USDT Computer Shown)

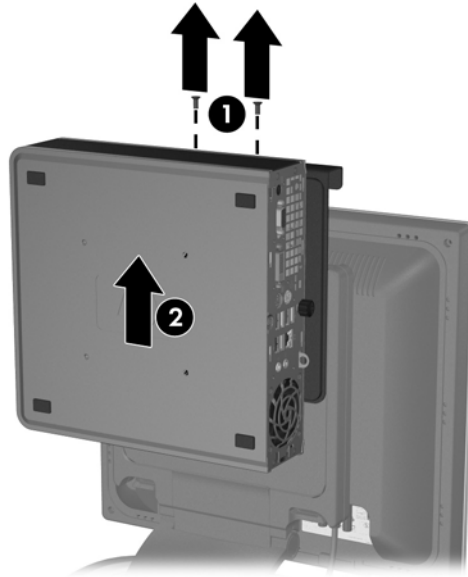

Removing the Monitor from the Stand

You can remove the monitor panel from the stand to mount the panel on a wall, a swing arm, or other mounting fixture.

△ **CAUTION:** Before beginning to disassemble the monitor, be sure the monitor is turned off and the power and signal cables are both disconnected.

1. Disconnect and remove the signal and power cables from the back of the monitor.
2. Adjust the monitor height to its highest position.
3. Press the Quick Release lever all the way to the left or right (1) then slide the monitor up and off the stand (2).

Figure 3-22 Removing the Monitor from the Stand



Monitor Mounting Alternatives

The HP Quick Release can be removed from the monitor stand and installed on a mounting fixture. This allows you to quickly and securely mount the monitor panel onto a swing arm, wall, desk or other mounting fixture.

1. Remove the monitor panel from the stand. Refer to [Removing the Monitor from the Stand on page 18](#).
2. Remove the HP Quick Release from the monitor stand by removing the four screws that secure the HP Quick Release to the stand.
3. Install the HP Quick Release onto the mounting fixture or wall then slide the monitor all the way down onto the HP Quick Release so that it clicks and locks in place.

△ **CAUTION:** The Quick Release is designed to support a maximum of up to 24 lbs. (10.9 kg). If you are mounting to a wall, HP recommends that you consult with a qualified engineering, architectural, or construction professional to determine the appropriate type and quantity of mounting fasteners required for the application and to ensure that the mounting solution is properly installed to support applied loads.

If mounting the monitor using another manufacturer's solution, use the screws previously removed from the monitor stand to mount the display to a swing arm or other mounting fixture. Consult the documentation included with the mounting fixture for additional instructions.

- △ **CAUTION:** This monitor supports the VESA industry standard 100 mm mounting holes. To attach a third-party mounting solution to the monitor, four 4 mm, 0.7 pitch, and 10 mm long screws are required (not provided with the monitor). Longer screws must not be used because they may damage the monitor. It is important to verify that the manufacturer's mounting solution is compliant with the VESA standard and is rated to support the weight of the monitor display panel. For best performance, it is important to use the power and video cables provided with the monitor.

Locating the Rating Labels

The rating labels on the monitor provide the spare part number, product number, and serial number. You may need these numbers when contacting HP about the monitor model. The rating labels are located on the rear panel of the monitor display head.

Figure 3-23 Locating the Rating Labels



- 📄 **NOTE:** The rating labels on some models may look different than the rating labels shown above.

4 Operating the Monitor

Software and Utilities

The CD that comes with the monitor contains files you can install on the computer:

- an .INF (Information) file
- an .ICM (Image Color Matching) file
- auto-adjustment pattern utility
- additional software for the monitor model

 **NOTE:** If the monitor does not include a CD, the .INF and .ICM files can be downloaded from the HP monitors support Web site. See [Downloading from the Worldwide Web on page 21](#).

The Information File

The .INF file defines monitor resources used by Microsoft Windows operating systems to ensure monitor compatibility with the computer's graphics adapter.

This monitor is Microsoft Windows Plug and Play compatible and the monitor will work correctly without installing the .INF file. Monitor Plug and Play compatibility requires that the computer's graphic card is VESA DDC2b-compliant and that the monitor connects directly to the graphics card. Plug and Play does not work through separate BNC type connectors or through distribution buffers/boxes.

The Image Color Matching File

The .ICM files are data files that are used in conjunction with graphics programs to provide consistent color matching from monitor screen to printer, or from scanner to monitor screen. The .ICM file contains a monitor color system profile. This file is activated from within graphics programs that support this feature.

 **NOTE:** The ICM color profile is written in accordance with the International Color Consortium (ICC) Profile Format specification.

Installing the .INF and .ICM Files

After you determine that you need to update, you can install the .INF and .ICM files from the CD or download them.

Installing from the CD

To install the .INF and .ICM files on the computer from the CD:

1. Insert the CD in the computer CD-ROM drive. The CD menu is displayed.
2. View the **Monitor Driver Software Readme** file.
3. Select **Install Monitor Driver Software**.
4. Follow the on-screen instructions.
5. Ensure that the proper resolution and refresh rates appear in the Windows Display control panel.

 **NOTE:** You may need to install the digitally signed monitor .INF and .ICM files manually from the CD in the event of an installation error. Refer to the *Monitor Driver Software Readme* file on the CD.





Downloading from the Worldwide Web

To download the latest version of .INF and .ICM files from the HP monitors support Web site:

1. Refer to <http://www.hp.com/support> and select the country region.
2. Follow the links for the monitor to the support page and download page.
3. Ensure the system meets the requirements.
4. Download the software by following the instructions.

Front Panel Controls

Table 4-1 Monitor Front Panel Controls

Control		Function
	Menu	Opens, selects or exits the OSD menu.
 auto	Minus	<ul style="list-style-type: none">• If the OSD menu is on, press to navigate backward through the OSD menu and decrease adjustment levels.• If the OSD menu is inactive, press to activate the auto adjustment feature to optimize the screen image.
	Plus	Navigates forward through the OSD menu and increases adjustment levels.
	Power LED	Green = Fully powered. Amber = Sleep mode. Flashing Amber = Sleep Timer mode.
	Power	Turns the monitor on or off.

Adjusting the Monitor Settings

The monitor settings can be adjusted from the On-Screen Display (OSD) menu or from the HP Display Assistant utility.

 **NOTE:** If there is a problem with the display settings, try resetting the settings to the factory defaults by opening the OSD and selecting **Factory Reset** from the OSD menu.

Using the On-Screen Display Menu

Use the On-Screen Display (OSD) to adjust the screen image based on your viewing preferences. To access the OSD, do the following:

1. If the monitor is not already on, press the **Power** button to turn on the monitor.
2. To access the OSD Menu, press the **Menu** button on the monitor's front panel.
3. To navigate through the OSD Menu, press the **+** (Plus) button on the monitor's front panel to scroll up, or the **-** (Minus) button to scroll in reverse.
4. To select an item from the OSD Menu, use the **+** or **-** buttons to scroll to and highlight your selection, then press the **Menu** button to select that function.
5. Adjust the item using the **+** or **-** buttons on the front panel to adjust the scale.
6. After adjusting the function, select **Save and Return**, or **Cancel** if you don't want to save the setting, then select **Exit** from the Main Menu.

 **NOTE:** If the buttons remain untouched for 10 seconds while displaying a menu, new adjustments will be discarded and the settings will revert to previous settings and exit the menu.

OSD Menu Selections

The following table lists the On-Screen Display (OSD) menu selections and their functional descriptions. After changing an OSD menu item, and if the menu screen has these options, you may choose to:

- **Cancel**—to return to the previous menu level.
- **Save and Return**—to save all changes and return to the OSD Main Menu screen. This Save and Return option is only active if you change a menu item.
- **Reset**—to change back to the previous setting.

 **NOTE:** The order and location of the OSD menu items vary by model. All OSD menu items listed below are not available on all monitor models.

Table 4-2 OSD Main Menu











Icon	Main Menu	Submenu	Description
	Brightness	Adjustable scale	Adjusts the brightness level of the screen. The factory default range is 90.
	Contrast	Adjustable scale	Adjusts the contrast level of the screen. The factory default range is 80.
	Image Control		Adjusts the screen image.
		Auto Adjustment	Automatically adjusts the screen image.
		Horizontal Position	Adjusts the position of the screen image left and right.
		Vertical Position	Adjusts the position of the screen image up and down.
		Custom Scaling (select models)	<p>Selects the method on how displayed information on the monitor will be formatted. Select:</p> <ul style="list-style-type: none"> • Fill to Screen - image fills the entire screen and may look distorted or elongated because of non-proportional scaling of height and width • Fill to Aspect Ratio - image is sized to fit the screen and maintains proportional image
		Clock	Minimizes any vertical bars or strips visible on the screen background. Adjusting the Clock will also change the horizontal screen image.
		Clock Phase	Adjusts the focus of the display. This adjustment allows you to remove any horizontal noise and clear or sharpen the image of characters.
	Color		Selects the screen color. The factory default is 6500 K.
		9300 K	Changes to slightly blueish white.
		6500 K	Changes to slightly reddish white.

Table 4-2 OSD Main Menu (continued)





Icon	Main Menu	Submenu	Description
		Custom Color	<p>Selects and adjusts your own color scales:</p> <ul style="list-style-type: none"> • R—sets your own red color levels • G—sets your own green color levels • B—sets your own blue color levels
		sRGB	<p>Sets your screen colors to adapt to the color standards used in the image technology industry.</p>
	Quick View (select models)		<p>Select the viewing mode.</p>
		Movie	<p>Select the movie mode.</p>
		Photo	<p>Select the photo mode.</p>
		Gaming	<p>Select the gaming mode.</p>
		Text	<p>Select the text mode.</p>
		Custom	<p>Settings saved when user adjusts the Brightness, Contrast, or Color in one of the Quick View options.</p>
	Language		<p>Selects the language in which the OSD menu is displayed. The factory default is English.</p>
	Management		<p>Selects the power management features of the monitor.</p> <p>NOTE: On some models, the OSD Control menu listed below is included in the Management menu.</p>
		OSD Control	<p>NOTE: On some models, the OSD Control menu listed below is included in the main menu.</p> <p>Adjusts the position of the OSD menu screen to:</p> <ul style="list-style-type: none"> • Horizontal OSD Position—Changes the viewing position of the OSD menu to the left or right area of the screen. The factory default range is 50. • Vertical OSD Position—Changes the viewing position of the OSD menu to the top or bottom area of the screen. The factory default range is 50. • OSD Transparency—Adjust to view the background information through the OSD • OSD Timeout—Sets the time duration in seconds that the OSD is visible after the last button is pressed. The factory default is 30 seconds. • OSD Rotation (select models)—Rotates the OSD Menu to support pivot function.
		Power Saver	<p>Enables the power saving feature. Select:</p> <ul style="list-style-type: none"> • On • Off <p>The factory default is On.</p>

Table 4-2 OSD Main Menu (continued)









Icon	Main Menu	Submenu	Description
		Power On Recall	Restores power to the monitor following an unexpected removal of power. Select: <ul style="list-style-type: none"> • On • Off <p>The factory default is On.</p>
		Mode Display	Displays the resolution, refresh rate and frequency information on the screen each time the OSD Main Menu is accessed. Select: <ul style="list-style-type: none"> • On • Off <p>Depending on monitor model, factory default is On or Off.</p>
		Power-On Status Display (select models)	Displays the operating status of the monitor each time the monitor is powered on. Select the location to display the status to: <ul style="list-style-type: none"> • Top • Middle • Bottom • Off <p>The factory default is Top.</p>
		DDC/CI Support (select models)	Allows the computer to control some OSD menu features such as brightness, contrast and color temperature. Set to: <ul style="list-style-type: none"> • On • Off <p>The factory default is On.</p>
		Bezel Power LED (select models)	Turns off the power LED on the front panel of the monitor. The factory default is On.
		Sleep Timer	Provides the timer adjustment menu options: <ul style="list-style-type: none"> • Set Current Time—sets the current time in hours and minutes • Set Sleep Time—sets the time you want to place the monitor in sleep mode • Set on Time—sets the time you want the monitor to wake up from sleep mode • Timer—sets the Sleep Timer feature On or Off. The default setting is Off • Sleep Now—immediately sets the monitor to enter sleep mode
	Information		Selects and displays important information about the monitor.
		Current Settings	Provides the current input video mode.
		Recommended Settings	Provides the recommended resolution mode and refresh rate for the monitor.

Table 4-2 OSD Main Menu (continued)

Icon	Main Menu	Submenu	Description
		Serial Number	Reports the serial number of the monitor. The serial number is needed if contacting HP technical support.
		Version	Reports the firmware version of the monitor.
		Total Hours	Reports the total hours of monitor operation.
		Backlight Hours	Reports the total hours of backlight operation.
		Service Support: http://www.hp.com/support	
	Factory Reset		Returns all OSD menu settings to the factory default setting, except the Language setting.
	Exit		Exits the OSD menu screen.

Adjusting Screen Quality

Allow the monitor to warm up for 20 minutes before performing the following procedures.

The Auto-Adjustment feature automatically fine-tunes the image quality each time a new video mode is displayed. If additional image quality improvement is desired, run the Auto-Adjust software on the CD and press the – (Minus) button on the monitor front panel to manually activate the Auto-Adjustment function.

For more precise adjustments, use the HP Display Assistant utility or run the Adjustment Pattern provided on the CD and use the Clock and Clock Phase controls (accessible from the OSD menu) as described in the following section.

Optimizing Digital Conversion

Two controls in the on-screen display can be adjusted to improve image performance: Clock and Clock Phase.

 **NOTE:** The Clock must first be set correctly since the Clock Phase settings are dependent on the main Clock setting. Use these controls only when the auto-adjustment function does not provide a satisfactory image.

- **Clock**—Increases/decreases the value to minimize any vertical bars or stripes visible on the screen background.
- **Clock Phase**—Increases/decreases the value to minimize video distortion or video jitter.

 **NOTE:** When using the controls, you will obtain the best results by using the auto-adjustment pattern software utility provided on the CD.

When adjusting the Clock and Clock Phase values, if the monitor images become distorted, continue adjusting the values until the distortion disappears. To restore the factory settings, select **Yes** from the Factory Reset menu in the on-screen display.

Using the HP Display Assistant Utility

HP Display Assistant, included on the software and documentation CD, is a software utility that guides you through the tuning process with easy to understand instructions and background patterns designed for each monitor control. It provides:

- Accurate screen calibration through the use of step-by-step instruction Wizards to obtain the best overall image quality
- Software control of the monitor image and color settings to eliminate dependence on the monitor's front panel buttons and On-Screen Display (OSD) menu
- Defined preset display settings for each individual user in a multi-user environment
- Multiple preset display settings for a single user based on content and ambient lighting
- Asset Management and Power Management capabilities that include remote control for individual or a group of displays on the domain from a centralized console application

The HP Display Assistant Utility has two modes of operation: Wizard and OSD mode. The preferred method of use is Wizard mode, which takes you through a step-by-step process to accurately calibrate the monitor. This method relies on a sequence of steps that will obtain the best display results when completed.

 **NOTE:** Refer to the HP Display Assistant user guide or online help for additional information about the software.

Identifying Monitor Conditions

Special messages will appear on the monitor screen when identifying the following monitor conditions:

- **Input Signal Out of Range—Change resolution setting to 1280 x 1024 – 60Hz**—Indicates the monitor does not support the input signal because the resolution and/or refresh rate are set higher than the monitor supports (models L1910i and LE1911i).
- **Input Signal Out of Range—Change resolution setting to 1440 x 900 – 60Hz**—Indicates the monitor does not support the input signal because the resolution and/or refresh rate are set higher than the monitor supports (model LE1901wi).
- **No Source Signal**—Indicates the monitor is not receiving a video signal from the PC on the monitor video input connector. Check to determine if the PC or input signal source is off or in the power saving mode.
- **Auto Adjustment is in Progress**—Indicates the auto-adjustment function is active.
- **Monitor Going to Sleep**—Indicates the screen display is entering a sleep mode.
- **Check Video Cable**—Indicates the video cable is not properly connected to the computer.
- **OSD Lockout**—The OSD can be enabled or disabled by pressing and holding the [Menu](#) button on the front panel for 10 seconds. If the OSD is locked, the warning message **OSD Lockout** displays for ten seconds.
 - If the OSD is locked, press and hold the [Menu](#) button for 10 seconds to unlock the OSD.
 - If the OSD is unlocked, press and hold the [Menu](#) button for 10 seconds to lock the OSD.

- **Power Button Lockout**—Indicates the power button is locked. If the power button is locked, the warning message **Power Button Lockout** displays.
 - If the power button is locked, press and hold the power button for 10 seconds to unlock the power button function.
 - If the power button is unlocked, press and hold the power button for 10 seconds to lock out the power button function.
- **Settings Saved as Custom**—Indicates that a Custom setting has been saved in the Quick View sub-menu. This occurs if a preset is selected in the Quick View menu then the Brightness, Contrast, or Color is also changed in the OSD.
- **Theft Mode Enabled**—Indicates that theft deterrence mode has been activated. Theft deterrence is an optional feature that can be set up in HP Display Assistant. Theft deterrence mode is triggered if both the power and display cables have been disconnected from the monitor, the monitor is reconnected to a different computer, and the theft deterrence PIN number is not entered within the elapsed time. When the monitor is in theft deterrence mode, all front panel buttons are disabled other than the power button.

Sleep Timer Mode

The Sleep Timer mode is an energy-saving feature that enables you to set a time for the monitor to power on and off at the same time every day. This also extends the life of the backlight bulbs in the monitor. The Sleep Timer has five settings:

- Set Current Time
- Set Sleep Time
- Set On Time
- Timer: On/Off
- Sleep Now

To set the timer:

1. Press the **Menu** button on the monitor front panel to display the **Main Menu**.
2. Scroll down and highlight **Management**.
3. Press the **Menu** button to select **Management**.
4. Scroll down and highlight and select **Sleep Timer > Set Current Time**.



NOTE: You must set the current local time before you reset the time for **Sleep Time** or **On Time**. Note that the time is displayed in a 24-hour clock format. For example, 1:15 p.m. is displayed as 13 hours 15 minutes.

5. Press the **Menu** button once to enter the adjustment mode for hours.
6. Press the **-** (Minus) or **+** (Plus) button to adjust the hour.
7. Press the **Menu** button again to enter the time for minutes.
8. Press the **-** (Minus) or **+** (Plus) button to adjust the minutes.
9. Press the **Menu** button to lock in the time chosen.

10. After setting the current time, the highlight automatically skips to **Set Sleep Time**. Repeat steps 6 through 9 to set **Sleep Time**.
11. If you do not want to set **Sleep Time**, press the **Menu** button twice, then select **Save and Return** to exit the menu.
12. After setting **Sleep Time**, the highlight automatically skips to **Set On Time**. Repeat steps 6 through 9 to set **On Time**.
13. Set the **Timer** mode to **On** to activate the **Sleep Timer** settings.
14. When you are finished, select **Save and Return** to exit the menu.

The fifth selection, **Sleep Now**, turns the monitor backlights off immediately and stays in sleep mode until the next **On Time** activates or a monitor button is pressed.

HP Display LiteSaver

HP Display LiteSaver is a software application, available on the CD, that increases monitor life and saves energy. It allows you to place the monitor into its low power sleep mode at predefined times by shutting down or reducing power to most internal circuits. This helps protect the LCD panel against image retention. Image retention can occur when the monitor is left on while displaying the same image for an extended period of time, leaving a shadow of the image on the screen.

Installing the HP Display LiteSaver Software

1. Insert the CD in the computer CD-ROM Drive. The CD menu is displayed.
2. Select **Install HP Display LiteSaver Software**.
3. After installing the software, click the **HP Display LiteSaver** icon in the Windows system tray or right-click the icon and select **Configure** from the pop-up menu.
4. Select the following options to configure the HP Display LiteSaver features:

Table 4-3 HP Display LiteSaver Configuration Options

Select This Option	To Do This
Enable Display LiteSaver	Enables the HP Display LiteSaver functions; deselect to disable the HP Display LiteSaver.
Display Off	Sets the time when the monitor automatically turns off. This does not affect screen saver operation, which has priority over the HP Display LiteSaver.
Display On	Sets the time when the monitor automatically turns on. This does not affect screen saver operation, which has priority over the HP Display LiteSaver.
Activity Extension	Sets the time in minutes before the monitor turns off if there is any keyboard or mouse activity after the Display Off time is reached. If the keyboard or mouse is used, then HP Display LiteSaver waits until the set amount of time before turning the display off again. Set to 0 to disable. If disabled, the monitor will turn off as soon as the Display Off time is reached, regardless of keyboard or mouse activity.
Show 1 minute Display Off Notice	Displays a popup message in the system tray 1 minute before the monitor is turned off by HP Display LiteSaver.
Status	Shows the time until the monitor is next due to be turned off by HP Display LiteSaver.
OK	Stores the current settings and minimizes HP Display LiteSaver to the System Tray.

Table 4-3 HP Display LiteSaver Configuration Options (continued)

Select This Option	To Do This
Cancel	Restores the previous settings and minimizes HP Display LiteSaver to the System Tray. HP Display LiteSaver will continue to run.
Help	Opens the online help file.
Exit	Exits and closes the HP Display LiteSaver. It will no longer control the monitor power until it is next run.

View *HP Display LiteSaver Readme* on the CD for additional information on how to configure HP Display LiteSaver.

sRGB Support

The monitor is designed to support sRGB for color management, which adapts to the color standards used in the image technology industry.

To take advantage of the sRGB support, you need to change the monitor's color temperature to sRGB and install the sRGB color profile (ICM) file.

 **NOTE:** The sRGB color temperature preset improves the color accuracy of sRGB images on the computer monitor, but some color variation may still occur.

Changing the Color Temperature

1. Press the **Menu** button on the front panel of the monitor to launch the **Main Menu** of the OSD.
2. Select **Color** and press the **Menu** button.
3. Select **sRGB** and press the **Menu** button.
4. Select **Save and Return** and press the **Menu** button to exit the menu.

Installing the sRGB ICM File for Microsoft Windows 2000 and Windows XP

 **NOTE:** To complete the following procedure, you must be logged in as an administrator or a member of the administrator's group. If the computer is connected to a network, network policy settings may prevent you from completing this procedure. The sRGB ICM file does not support Windows 95 and Windows NT operating systems.

1. Click the **Display** icon in the Control Panel.
2. In the **Display Properties** windows, select the **Settings** tab, then click the **Advanced** button.
3. Select the **Color Management** tab, then click the **Add** button to open the **Add Profile Association** dialog box.
4. Select the **sRGB Color Space Profile.icm** file, then click the **Add** button.
5. To activate a color profile for the monitor, you must set it as the Default Monitor Profile. Select **sRGB Color Space Profile**, then click the **Set as Default** button.
6. Click **Apply** or **OK**.

Installing the sRGB ICM File for Microsoft Windows Vista

1. Click **Appearance and Personalization** icon in the Control Panel.
2. Click **Personalization**.
3. Click **Display Settings**.
4. Click the **Advanced Settings** button.
5. Click the **Color Management** tab, then click the **Color Management** button.
6. Click the **Advanced** tab, then click the **Change System Defaults** button.
7. On the **Devices** tab, click the **Add** button.
8. Select the **sRGB Color Space Profile.icm** file, then click the **OK** button
9. To activate a color profile for the monitor, you must set it as the Default Monitor Profile. Select **sRGB Color Space Profile**, then click the **Set as Default** button.

A Troubleshooting

Solving Common Problems

The following table lists possible problems, the possible cause of each problem, and the recommended solutions.

Problem	Possible Cause	Solution
Screen is blank.	Power cord is disconnected.	Connect the power cord.
	Power switch on front panel of the monitor is turned off.	Press the front panel power button.
	Video cable is improperly connected.	Connect the video cable properly. Refer to Chapter 3, Setting Up the Monitor on page 5 for more information.
	Screen blanking is active.	Press any key on the keyboard or move the mouse to inactivate the screen blanking utility.
Screen image appears distorted; text is fuzzy or blurred; image quality is degraded.	The computer's graphics card resolution is set lower or higher than the monitor's native resolution.	Set the computer's display resolution to the same mode as the monitor's recommended native screen resolution to provide the best picture quality.
Image appears blurred, indistinct, or too dark.	Brightness and contrast are too low.	Press the -(Minus) button on the front panel. If this does not correct the image, press the Menu button to open the OSD Menu, and adjust the brightness and contrast scales as needed.
Image is not centered	Position may need adjustment.	Press the Menu button to access the OSD menu. Select Image Control/Horizontal Position or Vertical Position to adjust the horizontal or vertical position of the image.
Check Video Cable is displayed on screen.	Monitor video cable is disconnected.	Connect the VGA signal cable from the computer to the VGA connector on the monitor. Be sure that the computer power is off while connecting the video cable.
Input Signal Out of Range. Change Settings to 1280 x 1024 @ 60Hz (19" 4:3 models) OR Input Signal Out of Range. Change Settings to 1440 x 900 @ 60Hz (19" wide panel models) is displayed on screen.	Video resolution and/or refresh rate are set higher than what the monitor supports.	Restart the computer and enter Safe Mode. Change the settings to a supported setting (see Recognizing Preset Display Resolutions on page 38). Restart the computer so that the new settings take effect.

Problem	Possible Cause	Solution
HP Display LiteSaver doesn't turn off the monitor screen.	The Activity Extension time has not elapsed.	The default Activity Extension value is set to 10 minutes. The HP Display LiteSaver will wait to detect no input or movement from the keyboard or mouse for 10 consecutive minutes after the Display Off time has passed, before the monitor enters into low-power mode. For example, if the Display Off time is set to 5 minutes from the current time and the Activity Extension is set to 10 minutes, the HP Display LiteSaver will not actually turn off the display until 10 minutes of inactivity has elapsed, even though the Display Off time is 5 minutes from now.
	The HP Display LiteSaver may not be compatible with the computer system. Some notebook computers are not compatible and the monitor power can not be controlled.	<p>Confirm that the HP Display LiteSaver is compatible with the system.</p> <ol style="list-style-type: none"> 1. Right-click on the HP Display LiteSaver icon in the system tray. 2. Select Power Off Display from the menu. <p>The monitor screen should turn off if the system is compatible. To turn the monitor back on, wait 5 seconds and move the mouse.</p> <p>NOTE: If the monitor did not turn off, then the computer graphics driver is not compatible with the HP Display LiteSaver software.</p>
The monitor is off but it did not seem to enter into a low-power sleep mode.	The monitor's power saving control is disabled.	Check the monitor's OSD menu setting for power saving enable/disable controls. The control should be set to enable to allow the monitor to enter into low-power modes.
OSD Lockout is displayed.	The monitor's OSD Lockout function is enabled.	Press and hold the Menu button for 10 seconds to disable the OSD Lockout function.
Power Button Lockout is displayed.	The monitor's Power Button Lockout function is enabled.	Press and hold the power button for 10 seconds to unlock the power button function.

Online Technical Support

For the online access to technical support information, self-solve tools, online assistance, community forums of IT experts, broad multi-vendor knowledge , monitoring and diagnostic tools, go to <http://www.hp.com/support>

Preparing to Call Technical Support

If you cannot solve a problem using the troubleshooting tips in this section, you may need to call technical support. Have the following information available when you call:

- Monitor model number
- Serial number for the monitor
- Purchase date on invoice
- Conditions under which the problem occurred
- Error messages received
- Hardware configuration
- Hardware and software you are using

B Technical Specifications

 **NOTE:** All performance specifications are provided by the component manufacturers. Performance specifications represent the highest specification of all HP's component manufacturers' typical level specifications for performance and actual performance may vary either higher or lower.

LE1901wi Model

Table B-1 LE1901wi Specifications

Display	48.2 cm wide screen	19 inches wide screen
Type	TFT LCD	
Viewable Image Size	48.2 cm diagonal	19-inch diagonal
Tilt	-3 to 20°	
Maximum Weight (Unpacked)	7.5 kg	16.54 lbs.
Dimensions (include base)		
Height	47.9 cm	18.86 inches
Depth	26.1 cm	10.28 inches
Width	47.0 cm	18.50 inches
Maximum Graphic Resolution	1440 x 900 (60 Hz) analog input	
Optimum Graphic Resolution	1440 x 900 (60 Hz) analog input	
Text Mode	720 x 400	
Dot Pitch	0.2835 (H) x 0.2835 (W) mm	
Horizontal Frequency	24 to 83 kHz	
Vertical Refresh Rate	50 to 75 Hz	
Environmental Requirements Temperature		
Operating Temperature	5 to 35° C	41 to 95° F
Storage Temperature	-20 to 60° C	-4 to 140° F
Relative Humidity	20 to 90%	
Power Source	100 – 240 VAC, 50/60 Hz	

Table B-1 LE1901wi Specifications (continued)

Altitude:		
Operating	0 to 3657.6 m	0 to 12,000 feet
Storage	0 to 12192 m	0 to 40,000 feet
Power Consumption (maximum)	<29 watts	
Input Terminal	One VGA connector with cable included	

L1910i Model

Table B-2 L1910i Specifications

Display	19 inches	48.3 cm
Type	TFT LCD	
Viewable Image Size	19-inch diagonal	48.3 cm
Tilt	-5 to 20°	
Swivel	-90 to 90°	
Maximum Weight (Unpacked)	15.4 lbs.	7.0 kg
Dimensions (include base)		
Height	19.72 inches	50.1 cm
Depth	10.21 inches	25.95 cm
Width	16.3 inches	41.4 cm
Maximum Graphic Resolution	1280 × 1024 (75 Hz) analog input	
Optimum Graphic Resolution	1280 × 1024 (60Hz) analog input	
Text Mode	720 × 400	
Dot Pitch	0.294 (H) × 0.294 (W) mm	
Horizontal Frequency	24 to 83 kHz	
Vertical Refresh Rate	50 to 77 Hz	
Environmental Requirements Temperature		
Operating Temperature	41 to 95° F	5 to 35° C
Storage Temperature	-29 to 140° F	-33 to 60° C
Relative Humidity	20 to 80%	
Power Source	100 – 240 VAC, 50/60 Hz	
Altitude:		
Operating	0 to 12,000 feet	0 to 3657.6 m
Storage	0 to 40,000 feet	0 to 12192 m

Table B-2 L1910i Specifications (continued)

Power Consumption (maximum)	<47 watts
Input Terminal	One VGA connector with cable included

LE1911i Model

Table B-3 LE1911i Specifications

Display	48.3 cm	19 inches
Type	TFT LCD	
Viewable Image Size	48.3 cm diagonal	19-inch diagonal
Tilt	-5 to 25°	
Maximum Weight (Unpacked)	4.9 kg	10.8 lbs.
Dimensions (include base)		
Height	41.6 cm	16.4 inches
Depth	20.6 cm	8.11 inches
Width	41.4 cm	16.3 inches
Maximum Graphic Resolution	1280 x 1024 (60Hz) analog input	
Optimum Graphic Resolution	1280 x 1024 (60Hz) analog input	
Text Mode	720 x 400	
Dot Pitch	0.294 (H) x 0.294 (W) mm	
Horizontal Frequency	24 to 83 kHz	
Vertical Refresh Rate	50 to 76 Hz	
Environmental Requirements Temperature		
Operating Temperature	5 to 35° C	41 to 95° F
Storage Temperature	-20 to 60° C	-4 to 140° F
Relative Humidity	20 to 80%	
Power Source	100 – 240 VAC, 50 – 60 Hz	
Altitude:		
Operating	0 to 3657.6 m	0 to 12,000 feet
Storage	0 to 12192 m	0 to 40,000 feet
Power Consumption (maximum)	<47 watts	
Input Terminal	One VGA connector with cable included	

Recognizing Preset Display Resolutions

The display resolutions listed below are the most commonly used modes and are set as factory defaults. This monitor automatically recognized these preset modes and they will appear properly sized and centered on the screen.

LE1901wi Model

Table B-4 Factory Preset Modes

Preset	Pixel Format	Horz Freq (kHz)	Vert Freq (Hz)
1	640 × 480	31.5	59.9
2	640 × 480	37.5	75.0
3	720 × 400	31.5	70.1
4	800 × 600	37.9	60.3
5	800 × 600	46.9	75.0
6	832 × 624	49.7	74.5
7	1024 × 768	48.4	60.0
8	1024 × 768	60.0	75.0
9	1152 × 870	68.7	75.1
10	1152 × 900	61.8	66.0
11	1280 × 768	47.4	60.0
12	1280 × 960	60.0	60.0
13	1280 × 1024	64.0	60.0
14	1280 × 1024	80.0	75.0
15	1440 × 900	55.9	59.9

L1910i Model

Table B-5 Factory Preset Modes

Preset	Pixel Format	Horz Freq (kHz)	Vert Freq (Hz)
1	640 × 480	31.5	60.0
2	640 × 480	37.9	73.0
3	640 × 480	37.5	75.0
4	720 × 400	31.5	70.0
5	800 × 600	37.9	60.0
6	800 × 600	48.1	72.0
7	800 × 600	46.9	75.0
8	832 × 624	49.7	75.0
9	1024 × 768	48.4	60.0

Table B-5 Factory Preset Modes (continued)

10	1024 × 768	56.5	70.0
11	1024 × 768	60.0	75.0
12	1152 × 870	68.7	75.0
13	1152 × 900	71.7	76.0
14	1280 × 1024	64.0	60.0
15	1280 × 1024	80.0	75.0

LE1911i Model

Table B-6 Factory Preset Modes

Preset	Pixel Format	Horz Freq (kHz)	Vert Freq (Hz)
1	640 × 480	31.469	59.940
2	720 × 400	31.469	70.087
3	800 × 600	37.879	60.317
4	1024 × 768	48.363	60.004
5	1280 × 960	60.00	60.00
6	1280 × 1024	63.98	60.02

Entering User Modes

The video controller signal may occasionally call for a mode that is not preset if:

- You are not using a standard graphics adapter.
- You are not using a preset mode.

If this occurs, you may need to readjust the parameters of the monitor screen by using the on-screen display or HP Display Assistant software. Your changes can be made to any or all of these modes and saved in memory. The monitor automatically stores the new setting, then recognizes the new mode just as it does a preset mode. In addition to the 15 factory present modes, there are four user modes that can be entered and stored.

Energy Saver Feature

When the monitor is in its normal operating mode, the monitor uses less than 25 watts (LE1901wi) or 40 watts (L1910i) or 28 watts (LE1911i) of power and the Power light is green.

The monitor also supports a reduced power state. The reduced power state will be entered into if the monitor detects the absence of either the horizontal sync signal and/or the vertical sync signal. Upon detecting the absence of these signals, the monitor screen is blanked, the backlight is turned off, and the power light is turned amber. When the monitor is in the reduced power state, the monitor will utilize less than 1 watt of power. There is a brief warm up period before the monitor will return to its normal operating mode.

Refer to the computer manual for instructions on setting energy saver features (sometimes called power management features).

 **NOTE:** The above power saver feature only works when connected to computers that have energy saver features.

By selecting the settings in the monitor's Energy Saver utility, you can also program the monitor to enter into the reduced power state at a predetermined time. When the monitor's Energy Saver utility causes the monitor to enter the reduced power state, the power light blinks amber.

C Agency Regulatory Notices

Federal Communications Commission Notice

This equipment has been tested and found to comply with the limits for a Class B digital device, pursuant to Part 15 of the FCC Rules. These limits are designed to provide reasonable protection against harmful interference in a residential installation. This equipment generates, uses, and can radiate radio frequency energy and, if not installed and used in accordance with the instructions, may cause harmful interference to radio communications. However, there is no guarantee that interference will not occur in a particular installation. If this equipment does cause harmful interference to radio or television reception, which can be determined by turning the equipment off and on, the user is encouraged to try to correct the interference by one or more of the following measures:

- Reorient or relocate the receiving antenna.
- Increase the separation between the equipment and the receiver.
- Connect the equipment into an outlet on a circuit different from that to which the receiver is connected.
- Consult the dealer or an experienced radio or television technician for help.

Modifications

The FCC requires the user to be notified that any changes or modifications made to this device that are not expressly approved by Hewlett Packard Company may void the user's authority to operate the equipment.

Cables

Connections to this device must be made with shielded cables with metallic RFI/EMI connector hoods to maintain compliance with FCC Rules and Regulations.

Declaration of Conformity for Products Marked with the FCC Logo (United States Only)

This device complies with Part 15 of the FCC Rules. Operation is subject to the following two conditions:

1. This device may not cause harmful interference.
2. This device must accept any interference received, including interference that may cause undesired operation.

For questions regarding the product, contact:

Hewlett Packard Company
P. O. Box 692000, Mail Stop 530113
Houston, Texas 77269-2000
Or, call 1-800-HP-INVENT (1-800 474-6836)

For questions regarding this FCC declaration, contact:

Hewlett Packard Company
P. O. Box 692000, Mail Stop 510101
Houston, Texas 77269-2000
Or, call (281) 514-3333

To identify this product, refer to the Part, Series, or Model number found on the product.

Canadian Notice

This Class B digital apparatus meets all requirements of the Canadian Interference-Causing Equipment Regulations.

Avis Canadien

Cet appareil numérique de la classe B respecte toutes les exigences du Règlement sur le matériel brouilleur du Canada.

European Union Regulatory Notice

This product complies with the following EU Directives:

- Low Voltage Directive 2006/95/EC
- EMC Directive 2004/108/EC

Compliance with these directives implies conformity to applicable harmonized European standards (European Norms) which are listed on the EU Declaration of Conformity issued by Hewlett-Packard for this product or product family.

This compliance is indicated by the following conformity marking placed on the product:

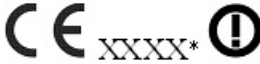
 <small>This marking is valid for non-Telecom products and EU harmonized Telecom products (e.g. Bluetooth).</small>	 <small>This marking is valid for EU non-harmonized Telecom products. *Notified body number (used only if applicable - refer to the product label).</small>
<small>This marking is valid for non-Telecom products and EU harmonized Telecom products (e.g. Bluetooth)</small>	<small>This marking is valid for EU non-harmonized Telecom products. *Notified body number (used only if applicable — refer to the product label).</small>

German Ergonomics Notice

HP products which bear the "GS" approval mark, when forming part of a system comprising HP brand computers, keyboards and monitors that bear the "GS" approval mark, meet the applicable ergonomic requirements. The installation guides included with the products provide configuration information.

Japanese Notice

この装置は、クラスB情報技術装置です。この装置は、家庭環境で使用することを目的としていますが、この装置がラジオやテレビジョン受信機に近接して使用されると、受信障害を引き起こすことがあります。取扱説明書に従って正しい取り扱いをして下さい。

VCCI-B

Korean Notice

B급 기기
(가정용 방송통신기기)

이 기기는 가정용(B급)으로 전자파적합등록을 한 기기로서 주로 가정에서 사용하는 것을 목적으로 하며, 모든 지역에서 사용할 수 있습니다.

Power Cord Set Requirements

The monitor power supply is provided with Automatic Line Switching (ALS). This feature allows the monitor to operate on input voltages between 100–120V or 200–240V.

The power cord set (flexible cord or wall plug) received with the monitor meets the requirements for use in the country where you purchased the equipment.

If you need to obtain a power cord for a different country, you should purchase a power cord that is approved for use in that country.

The power cord must be rated for the product and for the voltage and current marked on the product's electrical ratings label. The voltage and current rating of the cord should be greater than the voltage and current rating marked on the product. In addition, the cross-sectional area of the wire must be a minimum of 0.75 mm² or 18 AWG, and the length of the cord must be between 6 feet (1.8 m) and 12 feet (3.6 m). If you have questions about the type of power cord to use, contact an authorized HP service provider.

A power cord should be routed so that it is not likely to be walked on or pinched by items placed upon it or against it. Particular attention should be paid to the plug, electrical outlet, and the point where the cord exits from the product.

Japanese Power Cord Requirements

For use in Japan, use only the power cord received with this product.

△ **CAUTION:** Do not use the power cord received with this product on any other products.

Product Environmental Notices

ENERGY STAR® Qualification

HP Displays marked with the ENERGY STAR® certification mark meet the requirements of the U.S. Environmental Protection Agency (EPA) ENERGY STAR program. The EPA ENERGY STAR® certification mark does not imply endorsement by the EPA. As an ENERGY STAR Partner, Hewlett Packard Company has determined that this product meets the ENERGY STAR® program requirements for display energy efficiency.

The following ENERGY STAR® certification mark appears on all ENERGY STAR qualified displays:



The ENERGY STAR® program specifications for displays and computers were created by the EPA to promote energy efficiency and reduce air pollution through more energy-efficient equipment in homes, offices, and factories. One way products achieve this goal is by using the Microsoft Windows power management feature to reduce power consumption when the product is not in use.

The power management feature enables the computer to initiate a low-power or “sleep” mode after a period of user inactivity. When used with an external ENERGY STAR® qualified display, this feature also supports similar power management features for the display. To take advantage of these potential energy savings, users should use the default power management settings that are provided with ENERGY STAR qualified computers and displays. The default power management settings on ENERGY STAR qualified computers are preset to behave in the following ways when the system is operating on AC power:

- Turn off an external display after 15 minutes of user inactivity
- Initiate a low power sleep mode for the computer after 30 minutes of user inactivity

ENERGY STAR® qualified computers exit the low power sleep mode and ENERGY STAR qualified displays resume operation when the user resumes use of the computer. Examples include the user pressing the power/sleep button, receiving an input signal from an input device, receiving an input signal from a network connection with the Wake On LAN (WOL) feature enabled, etc.

Additional information on the ENERGY STAR® program, its environmental benefits and the potential energy and financial savings of the power management feature can be found on the EPA ENERGY STAR Power Management Web site at <http://www.energystar.gov/powermanagement>.

Materials Disposal

This HP product contains mercury in the fluorescent lamp in the display LCD that might require special handling at end-of-life.

Disposal of this material can be regulated because of environmental considerations. For disposal or recycling information, contact the local authorities or the Electronic Industries Alliance (EIA) <http://www.eiae.org>.

Disposal of Waste Equipment by Users in Private Household in the European Union



This symbol on the product or on its packaging indicates that this product must not be disposed of with your household waste. Instead, it is your responsibility to dispose of your waste equipment by handing it over to a designated collection point for the recycling or waste electrical and electronic equipment. The separate collection and recycling of your waste equipment at the time of disposal will help to conserve natural resources and ensure that it is recycled in a manner that protects human health and the environment. For more information about where you can drop off your waste equipment for recycling, please contact the local city office, the household waste disposal service or the shop where you purchased the product.

HP Recycling Program

HP encourages customers to recycle used electronic hardware, HP original print cartridges, and rechargeable batteries. For more information about recycling programs, go to <http://www.hp.com/recycle>.

Chemical Substances

HP is committed to providing our customers with information about the chemical substances in our products as needed to comply with legal requirements such as REACH (Regulation EC No 1907/2006 of the European Parliament and Council). A chemical information report for this product can be found at <http://www.hp.com/go/reach>.

Restriction of Hazardous Substances (RoHS)

A Japanese regulatory requirement, defined by specification JIS C 0950, 2005, mandates that manufacturers provide Material Content Declarations for certain categories of electronic products offered for sale after July 1, 2006. To view the JIS C 0950 material declaration for this product, visit <http://www.hp.com/go/jisc0950>.

2008年、日本における製品含有表示方法、JISC0950が公示されました。製造事業者は、2006年7月1日以降に販売される電気・電子機器の特定化学物質の含有につきまして情報提供を義務付けられました。製品の部材表示につきましては、www.hp.com/go/jisc0950を参照してください。

有毒有害物质/元素的名称及含量表

根据中国
《电子信息产品污染控制管理办法》

液晶显示器

部件名称	有毒有害物质和元素					
	铅 (Pb)	汞 (Hg)	镉 (Cd)	六价铬 (Cr(VI))	多溴联苯 (PBB)	多溴二苯醚 (PBDE)
液晶显示器显示面板	X	X	○	○	○	○
机箱/其它	X	○	○	○	○	○

CRT 显示器

部件名称	有毒有害物质和元素					
	铅 (Pb)	汞 (Hg)	镉 (Cd)	六价铬 (Cr(VI))	多溴联苯 (PBB)	多溴二苯醚 (PBDE)
阴极射线管	X	○	○	○	○	○
机箱/其它	X	○	○	○	○	○

O: 表示该有毒或有害物质在该部件所有均质材料中的含量均在 SJ/T11363-2006 标准规定的限量要求以下。

X: 表示该有毒或有害物质至少在该部件所用的某一均质材料中的含量超出 SJ/T11363-2006 标准规定的限量要求。

表中标有“X”的所有部件都符合欧盟 RoHS 法规 — “欧洲议会和欧盟理事会 2003 年 1 月 27 日关于电子电器设备中限制使用某些有害物质的 2002/95/EC 号指令”。

注: 环保使用期限的参考标识取决于产品正常工作的温度和湿度等条件。

Turkey EEE Regulation

In Conformity with the EEE Regulation

EEE Yönetmeliğine Uygundur

D LCD Monitor Quality and Pixel Policy

The TFT monitor uses high-precision technology, manufactured according to HP standards, to guarantee trouble-free performance. Nevertheless, the display may have cosmetic imperfections that appear as small bright or dark spots. This is common to all LCD displays used in products supplied by all vendors and is not specific to the HP LCD. These imperfections are caused by one or more defective pixels or sub-pixels.

- A pixel consists of one red, one green, and one blue sub-pixel.
- A defective whole pixel is always turned on (a bright spot on a dark background), or it is always off (a dark spot on a bright background). The first is the more visible of the two.
- A defective sub-pixel (dot defect) is less visible than a defective whole pixel and is small and only visible on a specific background.

To locate defective pixels, the monitor should be viewed under normal operating conditions, in normal operating mode at a supported resolution and refresh rate, from a distance of approximately 50 cm (20 in).

HP expects that, over time, the industry will continue to improve its ability to produce LCDs with fewer cosmetic imperfections and HP will adjust guidelines as improvements are made.