

XEROX®

XA7-19i / XA7-17i
LCD Monitor
User's Manual



©2004 by Xerox Corporation. All rights reserved.

Copyright protection claimed includes all forms and matters of copyrightable material and information now allowed by statutory judicial law or hereinafter granted, including without limitation, material generated from the software programs which are displayed on the screen such as icons, screen displays, looks, etc.

XEROX® and all Xerox product names mentioned in this publication are trademarks of XEROX CORPORATION. Other company trademarks are also acknowledged.

Changes are periodically made to this document. Changes, technical inaccuracies, and typographic errors will be corrected in subsequent editions.

Table of Contents

Federal Communications Commission (FCC) Statement	3
Important Safety Instructions	4
1 Introduction	
Features	7
Package Contents	8
Front View and Controls.....	9
Installing Your LCD Monitor.....	10
2 Installation	
Connecting Your LCD Monitor to a Computer	11
Method 1: Analog (D-SUB) Connection	11
Method 2: Digital(DVI) Connection	12
Using Your LCD Monitor.....	13
3 OSD MENU	
Using the OSD Menu	14
The OSD Options	15
4 Technical Information	
Preset Mode Timing Chart.....	18
DVI Connector PIN Assignment	19
D-SUB Connector PIN Assignment.....	20
Plug and Play	21
Visual Inspection	21
Troubleshooting.....	22

Federal Communications Commission (FCC) Statement

This equipment has been tested and found to comply with the limits of a class B digital device, pursuant to Part 15 of the FCC Rules. These limits are designed to provide reasonable protection against harmful interference in a residential installation. This equipment generates, uses and can radiate radio frequency energy and, if not installed and used in accordance with the instructions, may cause harmful interference to radio communications. However, there is no guarantee that interference will not occur in a particular installation. If this equipment does cause harmful interference to radio or television reception, which can be determined by turning the equipment off and on, the user is encouraged to try to correct the interference by one or more of the following measures:

1. Reorient/Relocate the receiving antenna.
2. Increase the separation between the equipment and receiver.
3. Connect the equipment into an outlet on a circuit which is different from what the receiver is connected to.
4. Consult the dealer or an experienced radio/TV technician for help.

**CAUTION:**

Changes or modifications not expressly approved by the manufacturer responsible for compliance could void the user authority to operate the equipment.

Important Safety Instructions

To prevent any injuries, the following safety precautions should be observed in the installation, use, servicing and maintenance of this equipment.

Before operating this equipment, please read this manual completely, and keep it nearby for future reference.

Warnings



- Do not place the equipment on any uneven or unstable carts, stands, tables, shelves etc. The equipment may fall, causing serious injury to children or adults and serious damage to the equipment itself.
- Use only a cart or stand recommended by the manufacturer. This equipment and recommended cart or stand should be handled with care. Quick stops, excessive force, and uneven surfaces may cause the equipment and cart/stand to overturn.
- Do not disable the 3-wire grounding type plug. The grounding pin on the 3-prong plug is an important feature. Removing the grounding pin will increase the risk of damaging the equipment. If you can not fit the plug into the electrical outlet, contact an electrician to install a grounding outlet.
- Always operate this equipment from the type of power source indicated on the rear of the serial/model plate.
- Never overload wall outlets and extensions.
- Use and handle the power cord with care.
- Do not place any heavy objects on the AC power cord.
- Do not pull the AC power cord. Do not handle the AC power cord with a wet hand.

- Do not touch the power cord and antenna cable during lightning.
- Remove the plug from the wall outlet if the equipment will not be used for a long period of time.
- Do not place, use or handle this equipment near water.
- Never expose the equipment to liquid, rain, or moisture. Seek qualified service if any of the above is spilled into the equipment.
- Do not attempt to service the equipment yourself.
- Opening and removing the covers may expose you to dangerous voltage or other hazards and may void your warranty. Refer service to qualified personnel.
- Always remove the power cord from the outlet before cleaning the equipment.
- Never use liquid or aerosol cleaners on the equipment. Clean only with a soft dry cloth.
- Do not expose the equipment to extreme temperature or to direct sunlight, as the equipment may heat up and suffer damage.
- Do not install the equipment near any heat sources such as radiators, heat registers, stoves, or any other apparatus that might produce heat.
- Do not block any ventilating openings. Leave an open space around the equipment.
- Never place the equipment on a bed, sofa, rug, or any other similar surfaces; too close to drapes/curtains/walls, in a bookcase, built-in cabinet, or any other similar places that may cause poor ventilation.

(continued on next page)

- If any of the following conditions occur, unplug the power cord from the outlet and request service from qualified personnel.
 - a. The power cord or plug is damaged.
 - b. Liquid is spilled into the product .
 - c. An object falls onto or into the product.
 - d. The product has been dropped or damaged.
 - e. The product's display is abnormal.

1 Introduction

Features

- **Analog Input:** Multi-scanning at horizontal frequencies of 30kHz to 80kHz and vertical frequencies of 60 Hz to 75 Hz.
- **Digital Input:** Multi-scanning at horizontal frequencies of 30kHz to 64kHz and vertical frequencies of 60 Hz to 75 Hz.
- Microprocessor based with OSD (On Screen Display) control.
- Compatible with standard IBM VGA, extended VGA, super VGA, IBM XGA modes, as well as VESA resolution standards.
- Universal power supply.
- Microsoft© Windows 9x/2000/XP compatible and VESA Display Data Channel(DDC)1/2B compatible.

Package Contents

Make sure all of the following contents are included in the box. If any items are missing, please return this product to the original place of purchase.

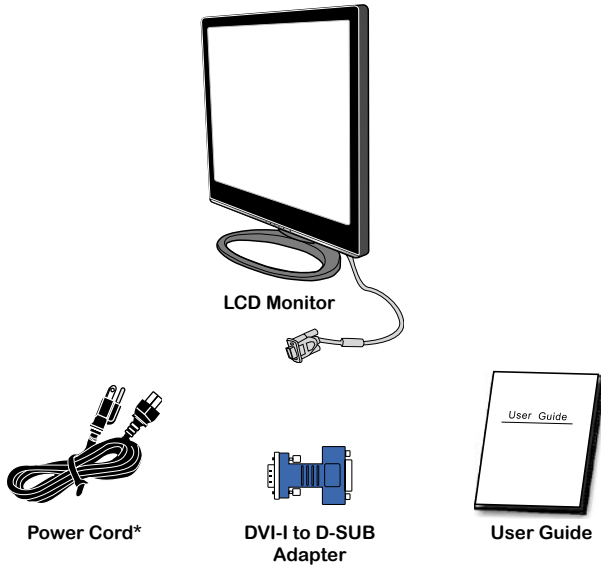

* Power cord specification : H05 VV-F 3G 0.75mm²



CAUTION:

Be sure to save original box and all packing material for future transport of monitor.

Front View and Controls

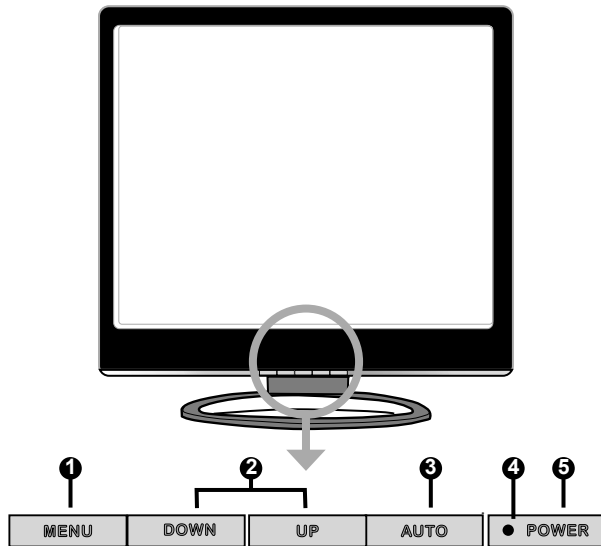

- 1 MENU**
Press once to display the OSD (on screen display). And press to activate the items you highlight .
- 2 DOWN/UP**
In OSD mode, press the DOWN/UP buttons to move the selection highlight to the next menu item counterclockwise or clockwise, respectively.
- 3 AUTO**
Press to automatically adjust the display settings to optimize performance based on the VGA signal.
- 4 LED**
The LED light indicates when the LCD monitor is activated (blue light indicates power on and blue flash indicates power saving).
- 5 POWER/ **
Turns the LCD monitor on and off.

Installing Your LCD Monitor

Follow the instructions below to set up and install the monitor.

- 1** The package contains:
1. Display unit
 2. Stand

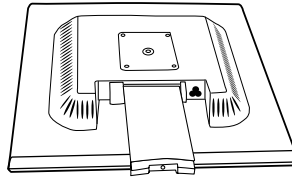

DISPLAY UNIT



STAND

- 2** Cover an even stable surface with a soft cloth. Place the unit face-down on the cloth. Fit the stand onto the bottom of the display unit as shown.

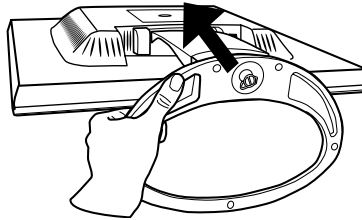

- 3** Use a coin to tighten the screw on the bottom of the stand until the screw is firmly fixed in place.

4

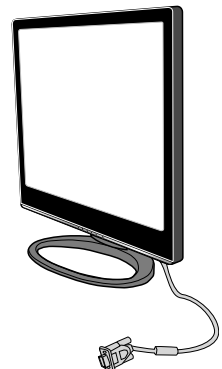
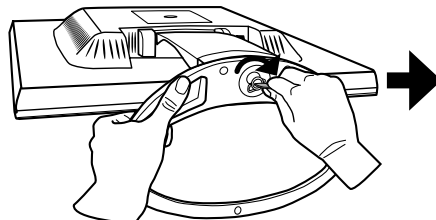

2 Installation

Refer to the owner's manual of the computer for connections. In the process of connecting external equipment, do not connect any AC power cords to wall outlets until all other connections are completed.

Connecting Your LCD Monitor to a Computer

Method 1: Analog (D-SUB) Connection

- 1 Turn off the computer and unplug the power cable.
- 2 Fit the DVI-I to D-SUB adapter onto the signal cable of the LCD monitor.
- 3 Connect the signal cable to the D-SUB port on the back of the computer.
- 4 Connect the AC power cable to the power socket on the back of the monitor.
- 5 Plug the computer and monitor power cables into a nearby outlet.
- 6 Press the **POWER/**  button on the front panel of the LCD monitor to turn the monitor on, then turn the computer on. If the monitor displays an image, the monitor is successfully installed. If no image is displayed, check all connections.

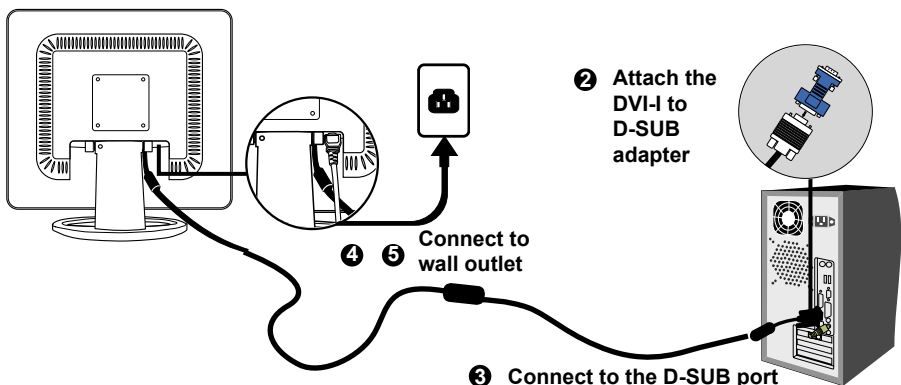

Method 2: Digital(DVI) Connection

- 1 Turn off the computer and unplug the power cable.
- 2 Connect the signal cable (DVI-I) to the DVI port on the back of the computer.
- 3 Connect the AC power cable to the power socket on the back of the monitor.
- 4 Plug the computer and monitor power cables into a nearby outlet.
- 5 Press the **POWER**/ button on the front panel of the LCD monitor to turn the monitor on, then turn the computer on. If the monitor displays an image, the monitor is successfully installed. If no image is displayed, check all connections.

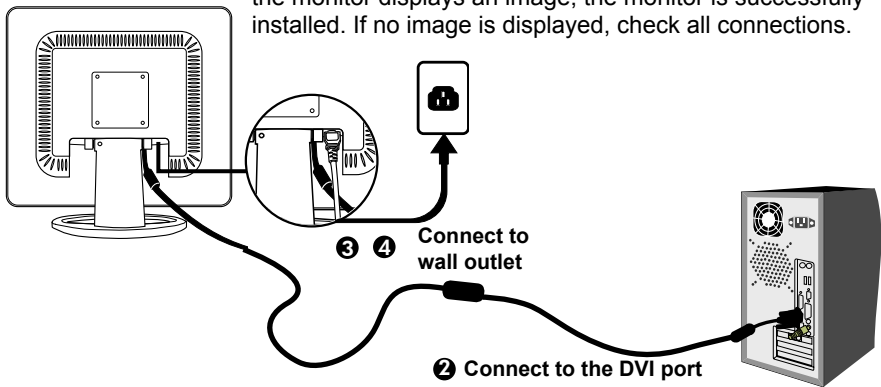

If the screen displays “out of range”, please follow the instructions below to set up:

- Press the **MENU** button to display the OSD.
- Press the **UP** or **DOWN** button to highlight the  (**INPUT SELECT**) icon, then press the **MENU** button. The OSD displays:

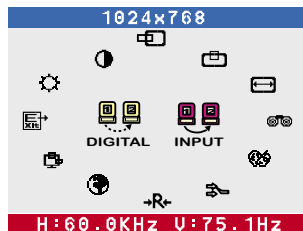

- Press the **UP** or **DOWN** button to select **DIGITAL INPUT**.

Using Your LCD Monitor

- 1 The angle of the LCD monitor may be adjusted approximately 25 degrees.

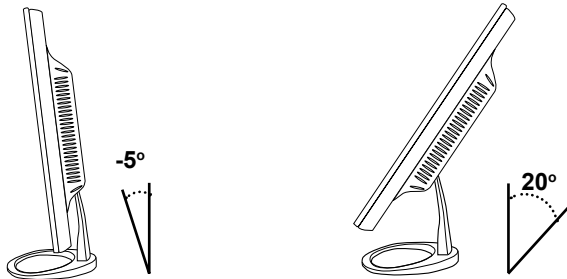

- 2 The **POWER/⏻** button is used for switching the LCD monitor on and off, it does not disconnect the device from the main voltage. To completely disconnect the main voltage, please remove the power plug from the socket.

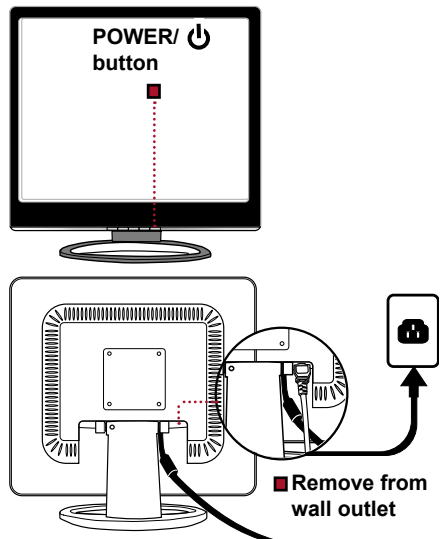

- 3 The LED indicator is blue when the monitor operates normally and will flash when in power saving mode. When the monitor is off, the LED turns dark.

3 OSD MENU

Using the OSD Menu

The OSD (On Screen Display) Menu allows the user to adjust various settings and options by following the steps below.

- 1 Press the **MENU** button to display the OSD.

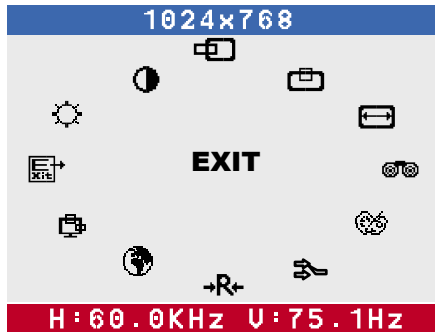

- 2 Press the **UP** or **DOWN** button to highlight the desired icon.
- 3 Press the **MENU** button to activate the highlighted icon.
- 4 Press the **UP** or **DOWN** button to change the value of the selected item.
- 5 Select the **EXIT** icon to exit the OSD.
- 6 Repeat steps 1 through 5 to make further adjustments. All changes are stored immediately.

The OSD Options

- 1 Press the **MENU** button to display the OSD. The OSD main menu provides an overview of the selection of controls available. To make an adjustment to the highlighted setting, press and release the **MENU** button.

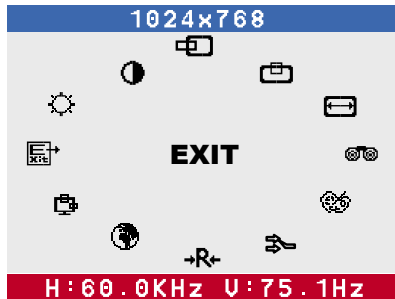

- 2 The OSD menu includes the following options:

Brightness

Controls the overall brightness.

Contrast

Controls the difference between the brightest and darkest regions of the picture.

H. Position

Adjust the position of the picture left and right in the window.

V. Position

Adjust the position of the picture up and down in the window.

H.Size

Adjusts the width of the picture.

Phase

Adjusts signal phase, which can improve focus clarity and image stability.

Color

Allows selection of the general color tint:

Select User Mode, WARM, or COOL.

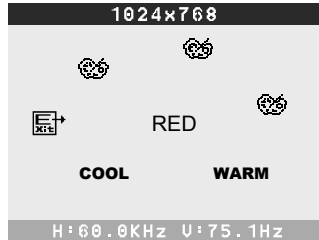

Select User Mode

Allows the user to adjust red, green and blue color component levels independently.

COOL

Inclines colors toward the blue end of the spectrum.

Fixes the red, green and blue component levels at factory settings; they cannot be independently adjusted.

WARM

Inclines colors toward the red end of the spectrum.

Fixes the red, green and blue component levels at factory settings; they cannot be independently adjusted.

EXIT

Exits the OSD menu.

Input Select

Allows selection of ANALOG INPUT or DIGITAL INPUT depending on the type of input signal currently in use.

Reset 

Restores all options to the factory settings.

Language 

Controls which language is used on all the on-screen menus.

OSD 

Changes the position of the OSD.

H. Position 

Moves the OSD left and right in the window.

V. Position 

Moves the OSD up and down in the window.

EXIT 

Exits the OSD menu.

EXIT 

Exits the OSD.

4 Technical Information

Preset Mode Timing Chart

The screen image has been optimized during manufacture for the display modes listed below.

Video signal: (IBM PC/AT)

Dot X Line	Horizontal Frequency(kHz)	Vertical Frequency(Hz)
720 x 400	31.47	70.00
640 x 480	31.47	60.00
	37.86	72.80
	37.50	75.00
800 x 600	35.16	56.25
	37.88	60.30
	48.08	72.20
	46.87	75.00
1024 x 768	48.36	60.00
	56.48	70.10
	60.02	75.00
1280 x 1024	63.98	60
	79.98	75

DVI Connector PIN Assignment

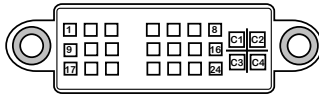

PIN	DESCRIPTION	PIN	DESCRIPTION
1	TMDS Data 2-	15	GND
2	TMDS Data 2+	16	Hot Plug Detect
3	TMDS Data 2/4 shield	17	TMDS Data 0-
4		18	TMDS Data 0+
5		19	TMDS Data 0/5 shield
6	DDC Clock	20	
7	DDC Data	21	
8	Analog Vertical Sync	22	Clock shield
9	TMDS Data 1-	23	Clock +
10	TMDS Data 1+	24	Clock -
11	TMDS Data 1/3 shield	C1	Analog red
12		C2	Analog green
13		C3	Analog blue
14	+5V Power	C4	Analog

D-SUB Connector PIN Assignment

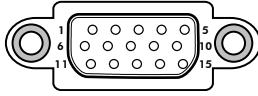

PIN	DESCRIPTION
1	Red
2	Green
3	Blue
4	Ground
5	Self Test
6	Red Ground
7	Green Ground
8	Blue Ground
9	5 VDC
10	Ground
11	Ground
12	SDA (FOR DDC)
13	H. Sync
14	V. Sync
15	SCL (FOR DDC)

Plug and Play

This monitor conforms to the VESA DDC (Display Data Channel) standard, which means that when it is used with a DDC compatible video card, the monitor is easier to set up. With VESA DDC 1/2B, when the monitor is turned on, it will automatically notify a windows 9X/2000/XP host computer of its scanning frequencies, capabilities and characteristics. Windows 9X/2000/XP will automatically recognize the presence of the monitor and select the appropriate display resolution.

Visual Inspection

Permanently unlit or lit pixels

The standard of production techniques today cannot guarantee an absolutely fault free LCD display. A few isolated permanently lit or unlit pixels may be present. The maximum permitted number of pixel faults is stipulated in the stringent international standard ISO 13406-2 (Class II).

Example:

A 17" flat-screen monitor with a resolution of 1280 x 1024 has 1280 x 1024 = 1310720 pixels. Each pixel consists of three subpixels (red, green and blue), so there are about 4 million dots in total.

According to ISO 13406-2 (Class II), a maximum of 6 pixels and 7 subpixels may be defective, i. e. a total of 25 faulted dots. This corresponds to approx. 0.002 % of the entire screen surface.

Troubleshooting

Before consulting service personnel, check the following chart for a possible cause and solution to the trouble you are experiencing.

Monitor will not turn on

- Make sure the power cord is plugged in.

No picture

- Make sure the power cord is plugged in.
- Check the signal cable connecting the LCD monitor and the computer (refer to page 11).
- Press the **POWER/⏻** button on the front panel of the monitor.

Poor picture or abnormal picture

- Check the DVI cable connecting the LCD monitor and the computer (refer to page 11).
- Press the **MENU** button to adjust the Brightness Contrast option in the OSD.
- Adjust the Color Select option in the OSD.
- Press the **AUTO** button on the front panel of the monitor, to automatically adjust the display mode.

Out of range message appears

- Press the **MENU** button. Highlight the **INPUT SELECT** icon, then press the **MENU** button. Press the **UP** or **DOWN** button to select **DIGITAL INPUT** (refer to page 12).
- If using Windows 9X/2000/XP, wait a few seconds; once Windows detects the problem, a dialog will appear allowing you to manually set up the video mode according to the preset mode timing chart (refer to page 18).