

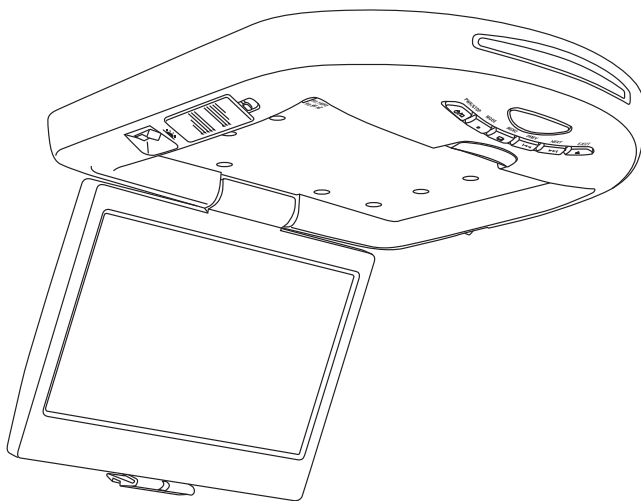

Owner's Manual

Mobile DVD/CD Player



**Models: MV6000
MV6000C**

For operational or technical assistance, after reading this manual,
please call us toll free at (800) 638-3600 or visit www.magnadyne.com

Features

- Compatible with PAL and NTSC Systems. This player can play discs recorded in either PAL or NTSC format.
- CD, DVD, CD-R, CD-RW, MP3 Compatible.
- L/R stereo analog audio outputs for connection to existing head unit aux. inputs. Video output is composite video.
- Supplied Remote Features: multi-language audio-track/subtitle, multi-angle (where available), plus all basic functions.

Use this Product Safely

Driving

Be aware of road and traffic conditions. Keep the volume at a low level.

Moisture

Do not expose the product to water or excessive moisture. This could cause electrical shorts, fire or other damage.

Parking

Parking in direct sunlight can produce very high temperatures inside your vehicle. Give the car interior a chance to cool down before starting playback.

Proper Power Supply

This product is designed to operate with a 12 Volt DC, negative ground battery system.

Protecting the Disc Mechanism

Avoid inserting any foreign objects into the slot of this player. Failure to observe this precaution may cause malfunction of this unit.

Repairs

Contact our customer service representatives. Do not attempt to disassemble or adjust this product yourself.

Installation

The unit should be installed in a horizontal position.

Contents

Safety Information	3	Headphones	12-13
Disc Notes	4	Headphone Operation	13
Screen and DVD/CD Functions	5-7	Basic Operation	14-15
Location of Functions	5	Turn the Unit On	14
Adjusting the Monitor	6	Loading a DVD/CD Disc	14
Inserting a DVD/CD	6	Ejecting a Disc	14
Changing to an Auxiliary Input Source	6	Standby State	14
Transmitter Frequency Selection	7	Basic Play	14-15
Car Radio Interface	7	Advanced Operation	16-17
Mono/Stereo Switch	7	Initial DVD Setup	18-19
Dome Light Operation	7	Specifications	20
Wiring Diagram	8	Troubleshooting	21
Wiring Instructions	9	Replacement Parts	22-23
Remote Control	10-11	Warranty	23
Remote Control Functions	10-11		

Safety Information

CAUTION:

THIS MOBILE DVD PLAYER IS A CLASS I LASER PRODUCT. HOWEVER, THIS MOBILE DVD PLAYER USES A VISIBLE/INVISIBLE LASER BEAM WHICH COULD CAUSE HAZARDOUS RADIATION EXPOSURE IF DIRECTED. BE SURE TO OPERATE THE MOBILE DVD PLAYER CORRECTLY AS INSTRUCTED. USE OF CONTROLS OR ADJUSTMENTS OR PERFORMANCE OF PROCEDURES OTHER THAN THOSE SPECIFIED HEREIN MAY RESULT IN HAZARDOUS RADIATION EXPOSURE. DO NOT OPEN COVERS AND DO NOT REPAIR YOURSELF. REFER SERVICING TO QUALIFIED PERSONNEL.

CAUTION:

FCC REGULATIONS STATE THAT ANY UNAUTHORIZED CHANGES OR MODIFICATIONS TO THIS EQUIPMENT MAY VOID THE USER'S AUTHORITY TO OPERATE IT.

WARNING:

- TO REDUCE THE RISK OF FIRE OR ELECTRIC SHOCK, DO NOT EXPOSE THIS EQUIPMENT TO RAIN OR MOISTURE.
- THIS DEVICE IS INTENDED FOR CONTINUOUS OPERATION.

- TO REDUCE THE RISK OF FIRE OR ELECTRIC SHOCK AND ANNOYING INTERFERENCE, USE ONLY THE RECOMMENDED ACCESSORIES.

This product incorporates copyright protection technology that is protected by method claims of certain U.S. patents and other intellectual property rights owned by Magnadyne Corporation and other rights owners. Use of this copyright protection technology must be authorized by Magnadyne Corporation and is intended for home and other limited viewing uses only unless otherwise authorized by Magnadyne Corporation. Reverse engineering or disassembly is prohibited.

Region Management Information:

This Mobile DVD Player is designed and manufactured to respond to the Region Management Information that is recorded on a DVD disc. If the Region number described on the DVD disc does not correspond to the Region number of this Mobile DVD Player, this Mobile DVD Player cannot play this disc.

Disc Notes

Disc Formats Supported by this Player:

	DVD 12 cm disc (Single-sided disc only)
	Video CD 12 cm disc
	CD 12 cm disc
	MP3 12 cm disc

Discs which cannot be played with this player:

- DVD-ROM
- DVD-R/DVD-RAM
- CDV
- CD-G

Disc Handling

- Dirt, dust, scratches and warping disc will cause non operation.
- Do not place stickers on disc or scratch disc.
- Do not warp discs.
- A disc should always be kept in its case when not in use to prevent damage.
- Do not place discs in the following places:
 1. Direct sunlight.
 2. Dirty, dusty and damp areas.
 3. Near car heaters.
 4. Car seats or dashboard.

Disc Cleaning

Use a dry soft cloth to wipe the surface. If the disc is quite dirty, use a soft cloth slightly moist with isopropyl (rubbing) alcohol. Never use solvents such as benzine, thinner or conventional record cleaners as they may mar the surface of the disc.

Note: A disc may become somewhat scratched (although not enough to make it unusable) depending on handling and conditions in the usage environment.

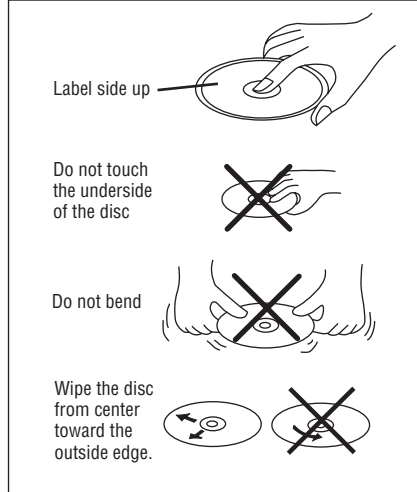

Preparing New Discs with Rough Spots

A new disc may have rough edges on its inside and outside edges. If a disc with rough edges is used, the proper setting will not be performed and the player will not play the disc. Therefore, remove the rough edges in advance by using a ball point pen or pencil as shown. To do this, press the side of the pen or pencil against the inside and outside edges of the disc.

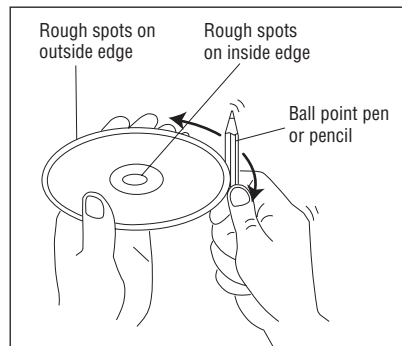

Screen and DVD/CD Functions

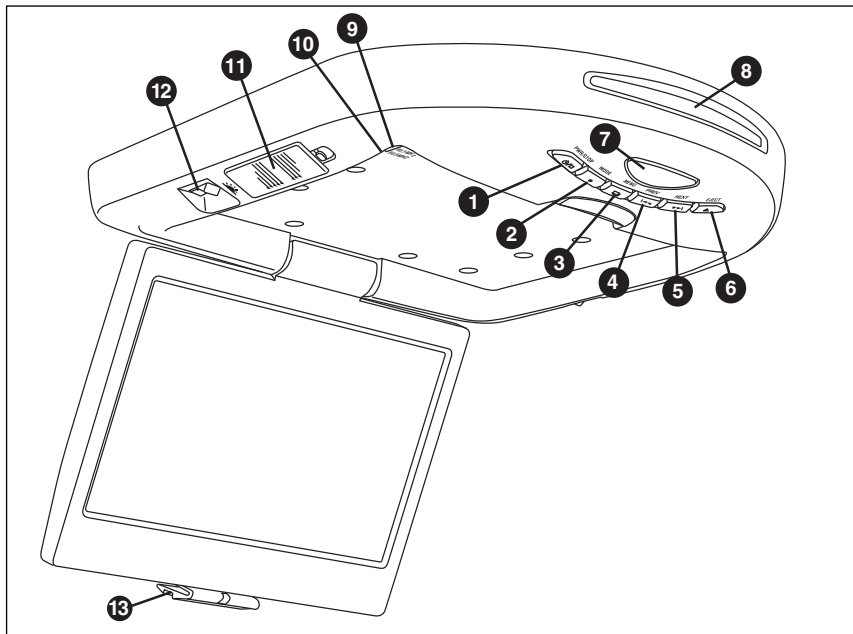





1. **PWR / STOP Button** (): Press this button to turn the unit On/Off. Press to stop disc play.
2. **MODE Button** (): Press this button to change the play source between DVD/CD player and an auxiliary input source.
3. **PLAY/PAU Button** (): Press this button to display on screen monitor controls.
4. **PREV Button** (): Press this button during playback to skip back to the previous track.
5. **NEXT Button** (): Press this button during playback to skip forward to the next track.
6. **EJECT Button** (): Press this button to eject the disc.
7. **Infrared Remote Sensor**: This is the sensor for the infrared remote.
8. **Disc Slot**: To play a DVD/CD, insert a disc into slot with label facing up.
9. **Transmitter Frequency Selection**: 3 position frequency switch to select a different frequency. It transmits a signal that is received by the MovieVision headphones. The signal can also be received by the vehicle's car radio.
10. **Mono/Stereo Switch**: Changes the unit from Mono to Stereo
11. **Dome Light**: The dome lights located in the MovieVision screen housing will illuminate whenever the vehicle doors are open.
12. **Dome Light Switch**: To activate the dome lights while the vehicle is in motion, press the dome light switch.
13. **Viewing Screen Release**: To release the screen, push inward on the tab and pull downward. Place the screen to the desired viewing position. To lock the viewing screen in the closed position, press upward on the edge of the screen housing until the screen locks into place (you will hear a snap sound).

Screen and DVD/CD Functions

Adjusting the Monitor:

Press the Menu button to activate the monitor adjustment menu. The following will be displayed on the screen:

	BRIGHTNESS	32
	CONTRAST	32
	COLOR	32
	TINT	32

1. Use the MENU button on the remote to activate the menu screen.
2. Press the MENU button again to select the desired monitor adjustment item.
3. Once an item has been selected for adjustment, press the VOLUME buttons (- or +) to make the desired adjustment to the monitor.
4. Press the MENU button again until the monitor adjustment menu disappears.

Inserting a DVD/CD

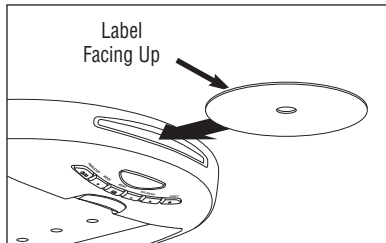

To play a DVD/CD, insert a disc into slot with label facing up.

Changing to an Auxiliary Input Source

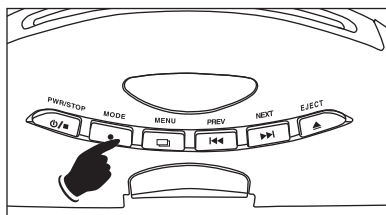

Press the MODE button to change the play source between DVD player and an auxiliary input source.

Screen and DVD/CD Functions

Transmitter Frequency Selection:

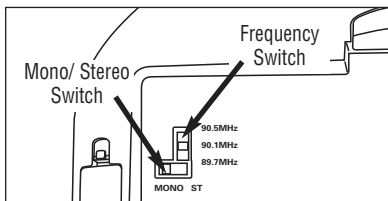

The MovieVision viewing screen transmits a signal that is received by the MovieVision headphones and can also be received by the vehicle's car radio. There are 3 frequencies available for use but only one can be used at a time. When you are listening to a movie using the wireless MovieVision headphones, it is possible that you could travel through an area where interference between the screen transmitter and the headphone receiver is at an unacceptable level. If this occurs, you can use the 3 position frequency switch located in the roof housing to select a different frequency that may have less or no interference. Each time you change the transmitting frequency, the headphone/car radio receiver will have to be retuned to the new frequency. The 3 frequencies available for use are 89.7MHz, 90.1MHz or 90.5MHz.

Car Radio Interface:

The signal transmitted from the MovieVision screen can be received by the existing FM car radio. This listening mode provides a much higher quality of sound for all. To listen to the MovieVision signal through the vehicle stereo system, use the following procedure:

- A. Turn "ON" the MovieVision system and insert a DVD/CD or attach an auxiliary signal source to view on the screen.
- B. Turn "ON" the FM radio in your vehicle and tune the radio to one of the 3 frequencies transmitted by the MovieVision system. (89.7MHz - 90.1MHz - 90.5MHz)
- C. Adjust the volume and tonal qualities to suit your listening taste.

Mono/Stereo Switch:

Use the Stereo setting for enhanced sound effect when environment is noisy or tends to have interference use Mono setting.

Dome Light Operation:

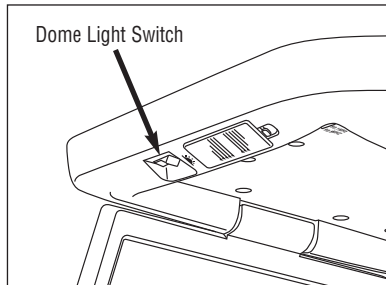

The dome lights located in the MovieVision screen housing will illuminate whenever the vehicle doors are open just as the original dome light did.

To activate the dome lights manually, press the dome light switch next to the desired dome light.

Note: Most American made vehicles (Ford, Chevrolet, Dodge) have a dashboard light dimmer switch that can be rotated to the maximum position and the dome lights will illuminate. Most Japanese or Korean made vehicles do not have this switch and the lights will have to be turned on manually as mentioned above.

Warning! In some cases, the dome light may be hot, proceed with caution. Only replace the bulb with the recommended size and wattage. Altering the size, shape or wattage will result in a damaged housing (melting). Use only Sylvania or GE model DE3021 for replacements.

Wiring Diagram

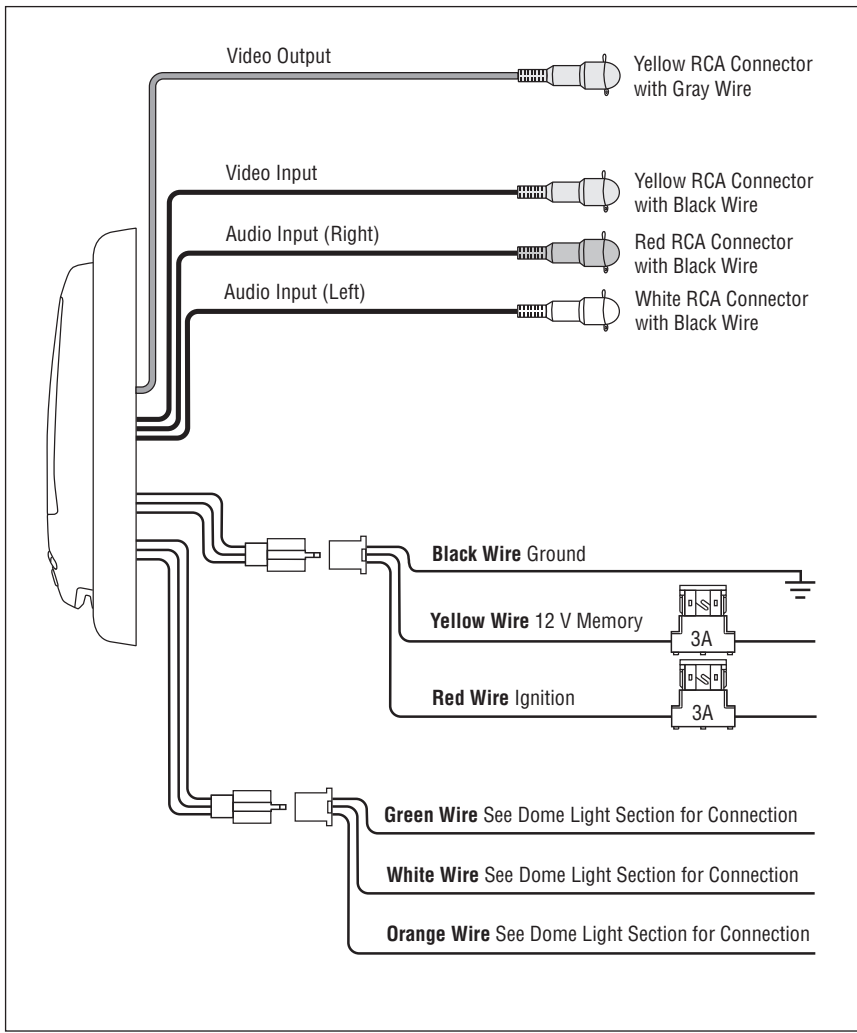

Wiring Instructions

Power Harness Wiring:

The 3 wire harness provides battery and ignition 12 volts as well as a chassis ground. Route the power harness to the point in the vehicle that you will make the connections.

Red Wire: The red wire in the harness should be connected to a +12 volt power wire that is turned on and off by the position of the ignition key.

Yellow Wire: The yellow wire in the harness should be connected to a constant +12 volt wire that is NOT turned on and off by the position of the ignition key.

Black Wire: The black wire in the harness should be connected to the chassis of the vehicle using a ring terminal and self tapping screw or existing bolt and nut.

Auxiliary Input:

You may use video games, camcorders and other portable video unit by connecting the unit to the color-coded auxiliary input connectors.

Note: These connectors are attached to black wires.

Yellow RCA Connector: Video input.

Red RCA Connector: Audio input right.

White RCA Connector: Audio input left.

Video Output:

You may output video to an optional monitor.

Note: This connector is attached to a gray wire.

Yellow RCA Connector: Video output.

Dome Light Harness Wiring:

Follow the enclosed wiring to connect the MovieVision dome light system to the factory installed dome light wiring

For **Negative Trigger** Dome Light Systems (typical to most vehicles):

Orange Wire: Connect to constant +12 volts.

Green Wire: Connect to the common trigger wire coming from all door pin switches (-).

White Wire: Connect to chassis ground.

For **Positive Trigger** Dome Light Systems (typical to many Ford vehicles):

Orange Wire: Connect to chassis ground.

Green Wire: Connect to the common trigger wire coming from all door pin switches (+).

White Wire: Connect to constant +12 volts.

Remote Control Locations

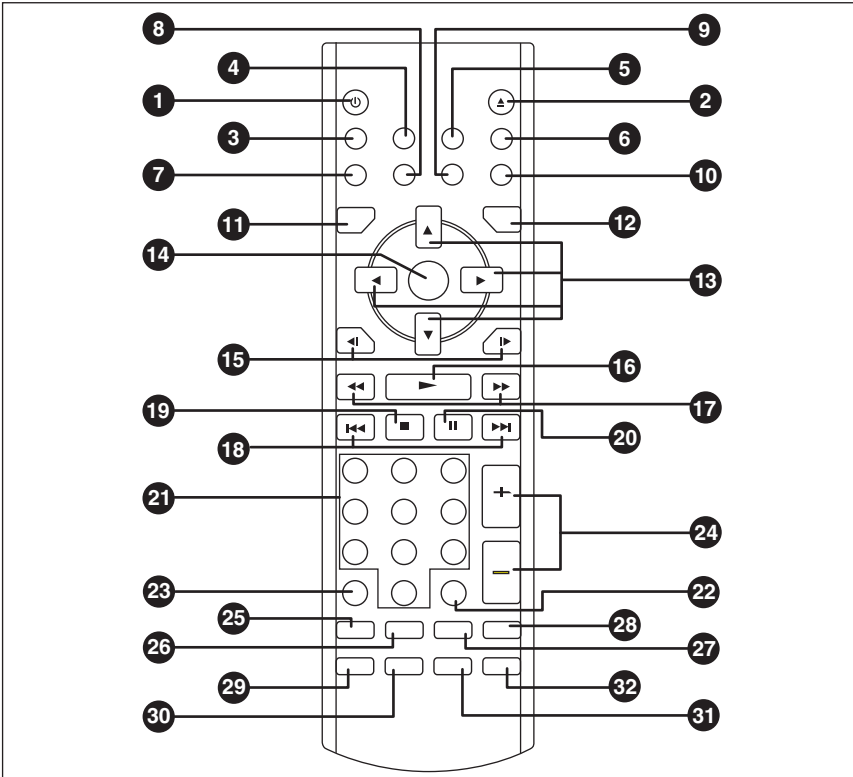







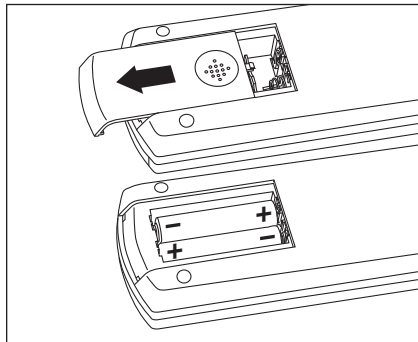







Preparing the Remote Control

Installing the Batteries:

1. Open the battery compartment cover.
2. Insert the two AAA size batteries. Make sure that the positive and negative terminals of the batteries are oriented correctly.
3. Close the battery compartment cover.



Remote Control Functions

1. **POWER:**  Turns the unit On/Off.
2. **EJECT:**  Ejects the disc.
3. **MUTE:** Mutes the sound.
4. **SUBTITLE:** Changes the SUBTITLE language on multi-subtitle language DVD disc.
5. **ANGLE:** Changes the view angle on multi-angle DVD disc.
6. **DISPLAY:** Displays statistical disc information during playback.
7. **MODE:** Changes between DVD/CD and AV input mode.
8. **SETUP:** Displays the SETUP menu.
9. **PAL/NTSC:** Switches between PAL and NTSC mode.
10. **AUDIO:** Changes the AUDIO soundtrack on multi-audio soundtrack DVD disc.
11. **TITLE:** Displays the TITLE menu that is stored on the DVD disc.
12. **MENU:** Activates the screen adjustment menu.
13. **NAVIGATION:** In MENU mode, , , ,  buttons serve as cursor buttons to select item left/right, forward/back.
14. **ENTER:** Confirms the Track/Chapter selected with the numeric buttons or selected with the cursor buttons on monitor screen.
15. **SLOW FW/RV:**   Slow FORWARD/REVERSE playback motion.
16. **PLAY:**  Plays the disc.
17. **RAPID FW/RV:**  Searches FORWARD rapidly.  REWINDS rapidly.
18. **SKIP:**  Skips forward one track.  Skips back one track.
19. **STOP:**  STOPS Play.
20. **PAUSE:**  PAUSES Play.
21. **0-9:** Numeric buttons.
22. **10+:** Digital selection button, used in combination with numeric buttons.
23. **CLEAR:** Clears number when input in error.
24. **VOLUME:** **VOLUME + / -** Increases or decreases the volume level.
25. **ZOOM:** Enlarges or reduces size of picture.
26. **RESUME:** Resumes playback from any set-up screen mode.
27. **GO TO:** Goes to the chapter or time that you selected.
28. **PBC:** Change between PBC On and PBC Off on the disc.
29. **RANDOM:** Plays CD tracks in RANDOM order.
30. **PROGRAM:** Plays CD tracks in the order programmed.
31. **REPEAT:** Switches the REPEAT mode of discs.
32. **A-B:** Allows a passage to be repeated continuously.

Headphones

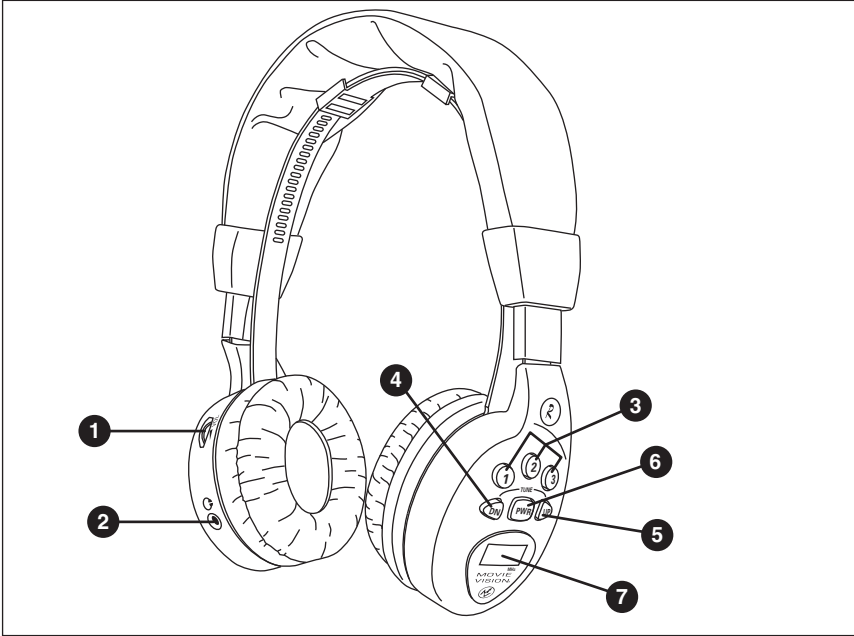

1. **VOL Knob:** Rotate to increase and decrease the volume level.
2. **Headphone Receptacle:** A second set of personal-type headphones (must have 3.5 mini male type plug) can be connected in this receptacle.
3. **Preprogrammed Buttons:** 3 pre-programmed buttons to tune the headphone radio to the exact MovieVision signal.
4. **Radio Tuning Down Button (DN):** Press to manually search down to tune in a FM radio station.
5. **Radio Tuning Down Button (UP):** Press to manually search up to tune in a FM radio station.
6. **PWR Button:** Press this button to turn the unit On/Off.
7. **Digital Display:** The digital display will show radio station frequency when the headphone is on.

Installing the Batteries:

To install the "AAA" batteries supplied, use the following procedure:

- A. Hold the headphones in one hand and place your thumb onto the gripping arrow on the battery holder cover.
- B. Press down on the gripping arrows while pulling downward on the battery door. Slide the door away from the headphones to expose the battery holder cavity.
- C. Place the batteries into the holder following the directions engraved inside the holder. Observe battery polarity.

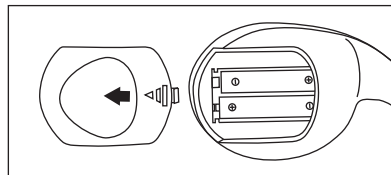

Headphones

The correct operation, care and maintenance of the headphones is critical to their ability to provide the user with a lifetime of operation. Misuse, abuse and neglect of the headphones will result in poor performance and premature failure.

WARNING!

- **Do not** throw the headphones.
- **Do not** get the headphones wet or submerge them in any liquid.
- **Do not** lay heavy objects on the headphones.
- Refrain from turning the volume of the headphones to the maximum position, this may result in ear damage.

Adjust the Headphones to Fit Your Head

- A. Spread the ear pads apart and place the headphones on your head. Observe the “L” and “R” indicators.
- B. Slide the adjuster up or down until a comfortable fit is achieved.

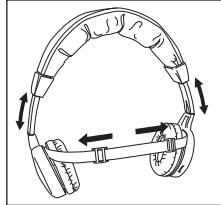

Headphone Operation

1. Turn On the Headphones:

To turn on the headphones, press the “PWR” button on the right side. The digital display will show radio station frequency when the headphone is on.

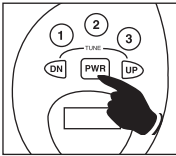

2. Tuning an FM Radio Station:

- A. Press the “UP” or “DOWN” button to manually tune in an FM radio station.
- B. Press and hold the “UP” or “DOWN” button for one second then release. The radio tuner will search up or down the radio band for the next strongest FM radio station.

Note: FM radio stations are always received in Stereo Mode.

- C. Adjust the volume knob to the desired volume level.

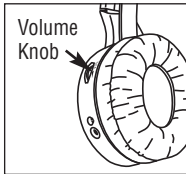
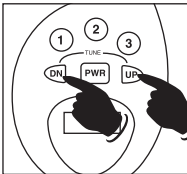

3. Listening to What is Displayed on the Screen:

On the right ear pad are 3 preprogrammed buttons marked 1, 2 and 3. These buttons will tune the headphone radio to the exact MovieVision signals. Press the buttons one at a time until what you hear in the headphones is what is displayed on the viewing screen.

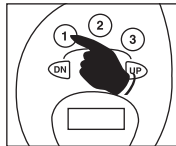

4. Turn Off the Headphones When Not in Use:

- A. Press the “PWR” button to turn off the headphones. The display will be blank when the headphones are off.
- B. The batteries will last for approximately 10 hours of continuous use. Forgetting to turn off the headphones when they are not in use will decrease the battery life.

5. Connecting a Second Set of Headphones

The MovieVision headphones have a receptacle located at the side of the “L” ear pad. A second set of personal-type headphones (must be a 3.5 mini male type plug) can be connected at this point.

Note: When a second pair of headphones are attached, the tuning and audio level is controlled by the MovieVision headphone.

Basic Operation

Turn the Unit On

1. Turn the car ignition on to the accessory position.
2. Press the **POWER**  button.



Loading a DVD/CD Disc

1. Insert the disc with printed side facing up into the disc slot. The player will automatically search the disc.
2. The player starts playback automatically.

Ejecting a Disc

Press the **EJECT**  button to eject disc.

Standby State

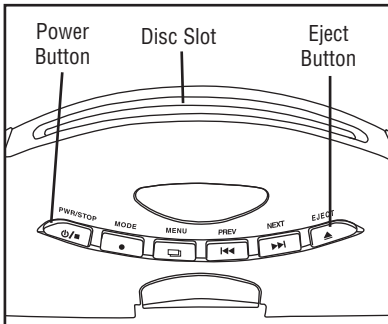

1. With the unit on, press **POWER**  on the remote.
2. In Standby State, press **POWER**  on the remote, again to recall playback.
3. To cancel Standby State, press **POWER**  on the unit's front panel.

Note: For Screen Saver mode select "On" in Screen Saver setup. The screen saver will automatically activate when playback is stopped or paused and there is no button operation for 5 minutes. Screen saver mode will release automatically when a disc is played. After 5 minutes, if the unit is not operated while in screen saver mode, it will enter standby state.





BASIC PLAY

Stopping Play



Press the **STOP**  button to stop the disc playback. Press the **PLAY**  button on the remote will continue with normal playback.

Press the **STOP**  button twice, to stop the playback and go back to initial Track/Chapter.

Pause (still picture)

Press **PAUSE**  during playback on the remote to stop play temporarily. Press **PLAY**  on remote to return to normal playback.

Rapid Forward/Rapid Reverse

Press **FF**  and **REW**  during play. Each time the button is pressed, the speed of rapid forward/reverse changes according to the disc as follows:

DVD:

Normal Playback → 2X → 4X → 6X → 8X

CD/MP3:

Normal Playback → 2X → 4X → 16X → 100X

Slow Motion Play (DVD Only)

Press **SLOW**  on the remote control during playback. Each time the button is pressed, the slow mode is changed according to the disc as follows:

DVD:

Normal Playback → 2X → 4X → 8X

Basic Operation

Skipping Track

Press **SKIP** ◀◀/▶▶ on the remote control during playback. Press ▶▶ to skip to next track and ◀◀ to skip back one track.

Mute

Mutes the sound, while the disc continues playing. When **MUTE** is pressed again, sound will resume to previous level.

Volume Level Adjustment

Press **VOLUME +/-** on the remote to increase or decrease volume level.

DVD Video Menu

When playing a DVD disc:

1. Disc will play automatically and stop at menu display.
2. Use **NAVIGATION** ◀/▶, ▲/▼ buttons on the remote to move the highlight bar in the menu.
3. Press **ENTER** to confirm selection.

Mode Selection

Press **MODE** on the front panel of the unit or **MODE** on the remote to select among DVD/CD and AV input modes. The indicator on the front panel of the unit will illuminate with the corresponding selection.

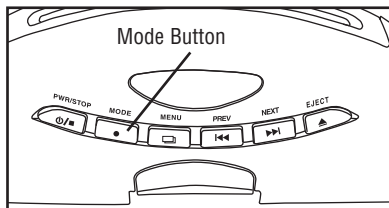

Last Play Memory

Press **POWER** (⏻) during play to turn "Off" the unit. Press again to turn "On" the unit. The DVD player will resume playing from the point at which it stopped.

- While the disc is playing press **MODE** to switch to AV input mode. The player will resume playing from the point at which it stopped.

Advanced Operation

Repeat Play/Repeat Paragraph Play:

Repeat Play (REPEAT, 31)

Press the **REPEAT** button to repeat a disc, track or chapter.

1. Press **REPEAT** button repeatedly to scan selection of repeat modes.
2. Pressing **REPEAT** will have different effects on various kinds of discs.

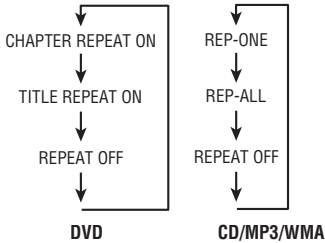

Press the **DISPLAY** button during playback to display the console information of the current disc onscreen.

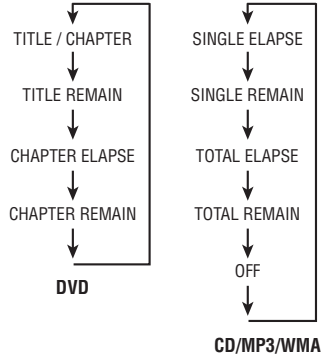

Repeat Paragraph (A-B, 32)

A-B (REPEAT) allows a passage to be repeated continuously.

1. Press A-B button at the start of the required passage.
2. Press A-B button again at the end of the passage.
3. The unit will repeat playing the passage set from **A** to **B**.
4. To revert to normal playing press **A-B** button again.

Console Information (CONSOLE, 6)

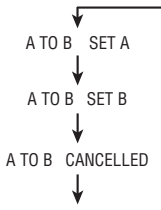

PAL/NTSC System Selection (PAL/NTSC, 9)

Press the **PAL/NTSC** button to switch between **PAL**, **NTSC** and **AUTO** modes.

NOTE: This function is only effective when **LOGO** is displayed. For instance, when there is no disc in the unit, ejecting a disc and in the **STOP** mode or pre-**STOP** mode when playing a DVD.

Advanced Operation

Random Playing (RANDOM, 30)

Press the **RANDOM** button during playback to play tracks in random order. Press **RANDOM** again to revert to normal playback.

Note: This function is effective only on a CD.

Zoom

Press the **ZOOM** button during playback of DVD to enlarge an area on the screen.

Note: In **ZOOM** mode press ◀/▶, ▲/▼ buttons to move images up, down, left or right to find the desired image to zoom in on.

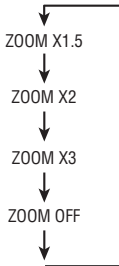

SPECIAL FUNCTIONS FOR DVD

Multi-Subtitle Language Function (SUBTITLE, 4)

Press **SUBTITLE** during playback. Each time the button is pressed the subtitle language on the screen changes.

Multi-Audio Language Function (AUDIO, 10)

Press **AUDIO** during playback. Each time the button is pressed, the audio soundtrack language on the screen changes in sequential order.

Multi-Angle Function (ANGLE, 5)

Press **ANGLE** during playback. Each time the button is pressed, the angle soundtrack language changes in sequential order.

Initial DVD Setup

INITIAL SETUP:

1. Turn the unit on without any disc inside the unit.
2. Press the **SETUP** button on the remote to view the Setup Menu - Main Page.

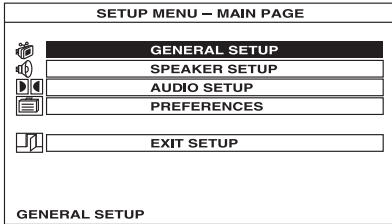

3. The Setup Menu - Main Page categories are:
General Setup
Speaker Setup
Audio Setup
Preferences
4. Select one of the four main menu categories by using the **NAVIGATIONAL** ▲/▼ buttons
5. Press the **ENTER** button to confirm selection.

GENERAL SETUP Submenu:

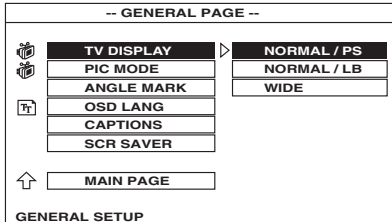

1. Use the **NAVIGATIONAL** ◀/▶, ▲/▼ buttons to scroll between the menu items.
2. Make a selection by pressing the **ENTER** button.
3. Press the **SETUP** button to exit the menu.

General Setup Submenu Options:

- TV Display:** Normal/PS, Normal/LB, Wide
- PIC Mode:** Auto, Hi-Res, N-Flicker
- Angle Mark:** On, Off
- OSD Lang:** English, French, German, Italian, Spanish
- Captions:** On, Off
- SCR Saver:** On, Off

SPEAKER SETUP Submenu:

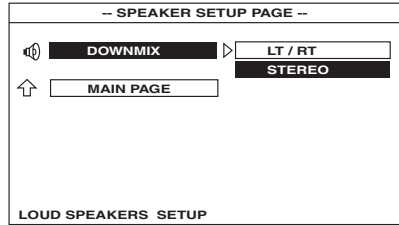

1. Use the **NAVIGATIONAL** ◀/▶, ▲/▼ buttons to scroll between the menu item.
2. Make a selection by pressing the **ENTER** button.
3. Press the **SETUP** button to exit the menu.

Speaker Setup Submenu Options:

Downmix: LT/RT, Stereo

AUDIO SETUP Submenu:

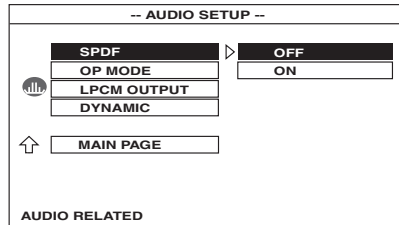

1. Use the **NAVIGATIONAL** ◀/▶, ▲/▼ buttons to scroll between the menu item.
2. Make a selection by pressing the **ENTER** button.
3. Press the **SETUP** button to exit the menu.

Audio Setup Submenu Options:

- SPDF:** On, Off
- OP Mode:** Line Out, RF REMOD
- LPCM Output:** LPCM 48K, LPCM 96K
- Dynamic:** Full, 6/8, 4/8, 2/8, Off

Initial DVD Setup

PREFERENCES SETUP Submenu:

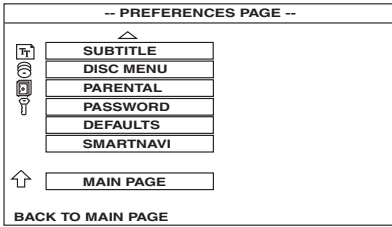

1. Use the **NAVIGATIONAL** ◀/▶, ▲/▼ buttons to scroll between the menu items.
2. Make a selection by pressing the **ENTER** button.
3. Press the **SETUP** button to exit the menu.

Preferences Setup Submenu Options:

TV Type: Auto, NTSC, PAL

Audio: English, French, Spanish, Chinese, Japanese, German, Italian

Subtitle: English, French, Spanish, Chinese, Japanese, German, Italian, Off

Disc Menu: English, French, Spanish, Chinese, Japanese, German, Italian, Off

Parental: 1 - G
 2 -
 3 - PG
 4 - PG 13
 5 -
 6 - PG R
 7 - NC 17
 8 - Adult
 No Parental

Password: Change (Enter 3308 if any change is preferred)

Defaults: Reset

SmartNav: No Menu, With Menu

Logo: Orig Logo, Cust Logo

Specifications

- Supply Voltage 12V DC, Negative Ground
- Current Consumption Less than 3A
- Signal System Composite Video 1.0Vp-p 75 Ω
- Compatible Discs DVD-Video Disc:
 - DVD 12 cm disc (single sided disc only)
- Compact Disc:
 - Video CD 12 cm disc
 - CD 12 cm disc
- MP3:
 - MP3 12 cm disc
- Specifications Frequency Response: 20 Hz - 20 KHz,
Signal to Noise Ratio: 80dB (JIS)
Wow and Flutter: Below Measurable Limits

Troubleshooting

Only qualified service personnel can remove the cover or service this player. Otherwise the warranty will become invalid.

No Power:

- Check to see if the player is set to "On".
- Check to see that the power plug of the main unit is properly connected.
- Check to see if that power to the outlet is properly working.

No Picture:

- Check to see that the monitor is switched to "On".
- Check that the correct Mode is selected (DVD or AV) by pushing the MODE button.
- Check the video connection.

Distorted Picture:

- Check the disc for fingerprints and clean with soft dry cloth, wiping from center to edge.
- A small amount of picture distortion may appear. This may not be a malfunction.

Completely Distorted Picture:

The disc format is not according to the monitor used (PAL/NTSC).

No Color in Picture:

The disc format is not according to the monitor used (PAL/NTSC).

No Sound:

- Check audio connections.
- If using a Hi-Fi amplifier, try another sound source.

Disc Does Not Play:

- Ensure the disc label is facing upwards.
- Clean the disc.
- Check to see if the disc is defective by trying another disc.

No Return to Start-Up Screen when Disc is Removed:

- Press **POWER** to turn "Off" the unit, then press it again to turn "On" the unit.
- Press **RESET** button "On" the front of the DVD unit.

The Player Does Not Respond to the Remote Control:

- Aim the remote control directly at the sensor on the front of the housing.
- Avoid all obstacles which may interfere with the signal path.
- Inspect or replace the remote control batteries.

Buttons Do Not Work:

- Press **POWER** to turn "Off" the unit, then press it again to turn "On" the unit.

DVD player showing "REGION ERROR":

- The DVD player and the discs all have a "REGION CODE". If the region number on the disc does not correspond to the region number of the DVD player the unit cannot play the disc.

Replacement Parts Order Form

Send Orders To: Magnadyne Corporation
ATTN: Consumer Parts Sales
P.O. Box 5365
Carson, CA 90749-5365

We Accept Checks, Money Orders, Visa and Master Card
Make Checks Payable to: Magnadyne Corporation

SHIP TO: (No P.O. Boxes)

LAST NAME

FIRST NAME

INITIAL

STREET ADDRESS (IF PAYING WITH A CREDIT CARD, YOUR BILLING ADDRESS IS REQUIRED)

CITY

STATE

ZIP CODE

DAYTIME PHONE NUMBER

CREDIT CARD INFORMATION:

CARD TYPE: VISA MASTER CARD

CARD NUMBER

EXP. MONTH

YEAR

NAME - EXACTLY AS IT APPEARS ON YOUR CREDIT CARD

Part #	Description	Qty.	Price Each	TOTAL
MV1500RM	Remote Control		\$39.95	

Shipping and Handling

Subtotal + Tax	Add
Up to \$20.00	\$5.00
20.01 to 30.00	5.95
30.01 to 45.00	6.50
45.01 to 70.00	6.95
Over 70.01	7.95

Subtotal = _____ . _____

California Residents Add Sales Tax = _____ . _____

Shipping and Handling (See Chart) = _____ . _____

TOTAL = _____ . _____

No C.O.D.'s

On regular orders please allow 4-5 weeks for delivery. Please give a shipping address where this order may be delivered between the hours of 9 a.m. and 5 p.m. weekdays. If UPS is unable to deliver, your order will be returned and additional shipping charges will be required.

**Order By Mail
Replacement Parts for MovieVision® Systems**

	DESCRIPTION	MODEL #	PRICE
	DVD Remote Control	MV1500RM	\$39.95 Ea.

Warranty

ONE (1) YEAR LIMITED WARRANTY

Magnadyne Corporation or its authorized agents will within 1 year from the date of sale to you, repair, replace or refund the retail sales price of said product or any part thereof, at the option of the Magnadyne Corporation or its authorized agents, if said product or part is found defective in materials or workmanship, when properly connected and operating on the correct power requirements designated for the specific product. This warranty and Magnadyne Corporation or its authorized agents obligations hereunder do not apply where the product was; damaged while in the possession of the consumer, subjected to unreasonable or unintended use, not reasonably maintained, utilized in commercial or industrial operations, or serviced by anyone other than Magnadyne Corporation or its authorized agents, or where the warning seal on the product is broken or the power and/or plugs are detached from the unit. Magnadyne Corporation or any of its authorized agents will not assume any labor costs for the removal and re-installation of any product found to be defective, or the cost of transportation to Magnadyne Corporation or its authorized agents. Such cost are the sole responsibility of the purchaser.

This warranty does not cover the cabinet appearance items or accessories used in connection with this product, or any damage to recording or recording tape, or any damage to the products resulting from improper installation, alteration, accident, misuse, abuse or acts of nature.

MAGNADYNE CORPORATION OR ITS AUTHORIZED AGENTS SHALL NOT BE LIABLE TO ANYONE FOR CONSEQUENTIAL OR INCIDENTAL DAMAGES OR CLAIMS EXCEPT THOSE ACCORDED BY LAW. NO EXPRESSED WARRANTY OR IMPLIED WARRANTY IS GIVEN EXCEPT THOSE SET FORTH HEREIN. NO IMPLIED WARRANTY SHALL EXTEND BEYOND 1 YEAR FROM THE DATE OF SALE.

This warranty extends only to the original purchaser of the product and is not transferable. Some states do not allow limitations on how long an implied warranty lasts and some states do not allow the exclusion or limitation of incidental or consequential damages, so the above limitations or exclusion may not apply to you. This warranty gives you specific legal rights and you may have other rights that vary from state to state.

Defective merchandise should be returned to the original point of purchase or secondly, to Magnadyne Corporation, 1111 W. Victoria Street, Compton CA 90220. Return Authorization must be obtained before sending, or merchandise may be refused.

