

# ViewSonic®

## VX1945wm LCD Display

- User Guide
- Guide de l'utilisateur
- Bedienungsanleitung
- Guía del usuario
- Guida dell'utente
- Guia do usuário
- Användarhandbok
- Käyttöopas
- Podręcznik użytkownika
- Használati útmutató
- Руководство пользователя
- Užívateľská príruka
- Kullanıcı kılavuzu
- Gebruikshandleiding
- Οδηγός χρηστών
- 使用手冊(繁體)
- 使用手冊(简体)
- 사용자 안내서
- ユーザーガイド
- دليل المستخدم



ViewSonic®

Model No. : VS11444

# Contents

Compliance Information.....	1
Important Safety Instructions.....	2
Declaration of RoHS Compliance.....	3
Copyright Information.....	4
Product Registration.....	4
<b>Getting Started</b>	
Package Contents.....	5
Precautions.....	5
Quick Installation.....	6
ViewDock™ Connecting to PC.....	7
Wall Mounting (Optional).....	8
<b>Using the LCD Display</b>	
Setting the Timing Mode.....	9
OSD and Power Lock Settings.....	9
Adjusting the Screen Image.....	10
Main Menu Controls.....	12
ViewDock™ Key Features.....	16
Physical Description.....	17
Card reader Installation.....	18
USB Hub Installation.....	19
ViewDock™ Connecting with iPod.....	20
Volume control of Sub Woofer.....	20
<b>Other Information</b>	
Specifications.....	21
Troubleshooting.....	22
Customer Support.....	23
Cleaning the LCD Display.....	24
Limited Warranty.....	25

# Compliance Information

## For U.S.A.

This device complies with part 15 of FCC Rules. Operation is subject to the following two conditions: (1) this device may not cause harmful interference, and (2) this device must accept any interference received, including interference that may cause undesired operation.

This equipment has been tested and found to comply with the limits for a Class B digital device, pursuant to part 15 of the FCC Rules. These limits are designed to provide reasonable protection against harmful interference in a residential installation. This equipment generates, uses, and can radiate radio frequency energy, and if not installed and used in accordance with the instructions, may cause harmful interference to radio communications. However, there is no guarantee that interference will not occur in a particular installation. If this equipment does cause harmful interference to radio or television reception, which can be determined by turning the equipment off and on, the user is encouraged to try to correct the interference by one or more of the following measures:

- Reorient or relocate the receiving antenna.
- Increase the separation between the equipment and receiver.
- Connect the equipment into an outlet on a circuit different from that to which the receiver is connected.
- Consult the dealer or an experienced radio/TV technician for help.

**Warning:** You are cautioned that changes or modifications not expressly approved by the party responsible for compliance could void your authority to operate the equipment.

## For Canada

This Class B digital apparatus complies with Canadian ICES-003.

Cet appareil numérique de la classe B est conforme à la norme NMB-003 du Canada.

## CE Conformity for European Countries



The device complies with the requirements of the EEC directive 89/336/EEC as amended by 92/31/EEC and 93/68/EEC Art.5 with regard to "Electromagnetic compatibility", and 73/23/EEC as amended by 93/68/EEC Art.13 with regard to "Safety."

## Following information is only for EU-member states:

The mark shown to the right is in compliance with the Waste Electrical and Electronic Equipment Directive 2002/96/EC (WEEE).

The mark indicates the requirement NOT to dispose the equipment as unsorted municipal waste, but use the return and collection systems according to local law.



# Important Safety Instructions

1. Read these instructions completely before using the equipment.
2. Keep these instructions in a safe place.
3. Heed all warnings.
4. Follow all instructions.
5. Do not use this equipment near water. Warning: To reduce the risk of fire or electric shock, do not expose this apparatus to rain or moisture.
6. Clean with a soft, dry cloth. If further cleaning is required, see “Cleaning the Display” in this guide for further instructions.
7. Do not block any ventilation openings. Install the equipment in accordance with the manufacturer’s instructions.
8. Do not install near any heat sources such as radiators, heat registers, stoves, or other devices (including amplifiers) that produce heat.
9. Do not attempt to circumvent the safety provisions of the polarized or grounding-type plug. A polarized plug has two blades with one wider than the other. A grounding type plug has two blades and a third grounding prong. The wide blade and the third prong are provided for your safety. If the plug does not fit into your outlet, consult an electrician for replacement of the outlet.
10. Protect the power cord from being tread upon or pinched, particularly at the plug, and the point where it emerges from the equipment. Be sure that the power outlet is located near the equipment so that it is easily accessible.
11. Only use attachments/accessories specified by the manufacturer.
12. Use only with the cart, stand, tripod, bracket, or table specified by the manufacturer, or sold with the equipment. When a cart is used, use caution when moving the cart/equipment combination to avoid injury from tipping over.
13. Unplug this equipment when it will be unused for long periods of time.
14. Refer all servicing to qualified service personnel. Service is required when the unit has been damaged in any way, such as: if the power-supply cord or plug is damaged, if liquid is spilled onto or objects fall into the unit, if the unit is exposed to rain or moisture, or if the unit does not operate normally or has been dropped.



# Declaration of RoHS Compliance

This product has been designed and manufactured in compliance with Directive 2002/95/EC of the European Parliament and the Council on restriction of the use of certain hazardous substances in electrical and electronic equipment (RoHS Directive) and is deemed to comply with the maximum concentration values issued by the European Technical Adaptation Committee (TAC) as shown below:

Substance	Proposed Maximum Concentration	Actual Concentration
Lead (Pb)	0.1%	< 0.1%
Mercury (Hg)	0.1%	< 0.1%
Cadmium (Cd)	0.01%	< 0.01%
Hexavalent Chromium (Cr <sup>6+</sup> )	0.1%	< 0.1%
Polybrominated biphenyls (PBB)	0.1%	< 0.1%
Polybrominated diphenyl ethers (PBDE)	0.1%	< 0.1%

Certain components of products as stated above are exempted under the Annex of the RoHS Directives as noted below:

Examples of exempted components are:

1. Mercury in compact fluorescent lamps not exceeding 5 mg per lamp and in other lamps not specifically mentioned in the Annex of RoHS Directive.
2. Lead in glass of cathode ray tubes, electronic components, fluorescent tubes, and electronic ceramic parts (e.g. piezoelectronic devices).
3. Lead in high temperature type solders (i.e. lead-based alloys containing 85% by weight or more lead).
4. Lead as an alloying element in steel containing up to 0.35% lead by weight, aluminium containing up to 0.4% lead by weight and as a copper alloy containing up to 4% lead by weight.

# Copyright Information

Copyright © ViewSonic® Corporation, 2006. All rights reserved.

Macintosh and Power Macintosh are registered trademarks of Apple Computer, Inc.

Microsoft, Windows, Windows NT, and the Windows logo are registered trademarks of Microsoft Corporation in the United States and other countries.

ViewSonic, the three birds logo, OnView, ViewMatch, and ViewMeter are registered trademarks of ViewSonic Corporation.

VESA is a registered trademark of the Video Electronics Standards Association. DPMS and DDC are trademarks of VESA.

ENERGY STAR® is a registered trademark of the U.S. Environmental Protection Agency (EPA).

As an ENERGY STAR® partner, ViewSonic Corporation has determined that this product meets the ENERGY STAR® guidelines for energy efficiency.

Disclaimer: ViewSonic Corporation shall not be liable for technical or editorial errors or omissions contained herein; nor for incidental or consequential damages resulting from furnishing this material, or the performance or use of this product.

In the interest of continuing product improvement, ViewSonic Corporation reserves the right to change product specifications without notice. Information in this document may change without notice.

No part of this document may be copied, reproduced, or transmitted by any means, for any purpose without prior written permission from ViewSonic Corporation.

# Product Registration

To meet your future needs, and to receive any additional product information as it becomes available, please register your product on the Internet at: [www.viewsonic.com](http://www.viewsonic.com). The ViewSonic Wizard CD-ROM also provides an opportunity for you to print the registration form, which you may mail or fax to ViewSonic.

<b>For Your Records</b>	
Product Name:	VX1945wm ViewSonic 19" LCD Display
Model Number:	VS11444
Document Number:	VX1945wm-3_UG_ENG Rev. 1B 12-14-06
Serial Number:	_____
Purchase Date:	_____

### Product disposal at end of product life

The lamp in this product contains mercury. Please dispose of in accordance with local, state or federal laws.

ViewSonic is concerned about the preservation of our environment. Please dispose of this product properly at the end of its useful life.

# Getting Started

Congratulations on your purchase of a ViewSonic® LCD display.

**Important!** Save the original box and all packing material for future shipping needs.

**NOTE:** The word “Windows” in this user guide refers to the following Microsoft operating systems: Windows ‘95, Windows NT, Windows ‘98, Windows 2000, Windows Me (Millennium), Windows XP, and Windows Vista.

## Package Contents

Your LCD display package includes:

- LCD display
- Power cable (for monitor)
- 15 Pin VGA video cable
- DVI-D cable
- USB connector cable \* 1 (A-B Type)
- Stereo audio cable \* 1
- 2 in 1 audio cable \* 1
- iPod adaptors
- Power adapter \*1 (for ViewDock™)
- ViewSonic Wizard CD-ROM \* 2
- Quick Start Guide

**NOTE:** The CD includes the User Guide PDF files and INF/ICM display optimization files. The INF file ensures compatibility with Windows operating systems, and the ICM file (Image Color Matching) ensures accurate on-screen colors. ViewSonic recommends that you install both the INF and ICM files.

## Precautions

- 
- Sit at least 18” from the LCD display.
  - **Avoid touching the screen.** Skin oils are difficult to remove.
  - **Never remove the rear cover.** This LCD display contains high-voltage parts. You may be seriously injured if you touch them.
  - Avoid exposing the LCD display to direct sunlight or another heat source. Orient the LCD display away from direct sunlight to reduce glare.
  - Always handle the LCD display with care when moving it.
  - Place the LCD display in a well ventilated area. Do not place anything on the LCD display that prevents heat dissipation.
  - Ensure the area around the LCD display is clean and free of moisture.
  - Do not place heavy objects on the LCD display, video cable, or power cord.
  - If smoke, an abnormal noise, or a strange odor is present, immediately switch the LCD display off and call your dealer or ViewSonic. It is dangerous to continue using the LCD display.
  - Do not rub or apply pressure to the LCD panel, as it may permanently damage the screen.
-

# Quick Installation

## 1. Connect power cord (and AC/DC adapter if required)

## 2. Connect video cable

- Make sure both the LCD display and computer are turned OFF
- Remove rear panel covers if necessary
- Connect the video cable from the LCD display to the computer

*Macintosh users:* Models older than G3 require a Macintosh adapter. Attach the adapter to the computer and plug the video cable into the adapter.

To order a ViewSonic® Macintosh adapter, contact ViewSonic Customer Support.

## 3. Turn ON LCD display and computer

Turn ON the LCD display, then turn ON the computer. This sequence (LCD display before computer) is important.

**NOTE:** Windows users may receive a message asking them to install the INF file. This is on the CD.

## 4. Insert the ViewSonic Wizard CD into the computer's CD drive.

Follow the on-screen instructions. If your computer does not have a CD-ROM drive, please refer to Customer Support page.

- Wait for the CD-ROM to auto-start.

**NOTE:** If the CD-ROM does not auto-start: double-click on the CD-ROM icon in the Windows Explorer, then double-click on **viewsonic.exe**.

- Follow the on-screen instructions.

## 5. Windows users: Set the timing mode (resolution and refresh rate)

*Example:* 1440 x 900 @ 60 Hz.

For instructions on changing the resolution and refresh rate, see the graphics card's user guide.

**Installation is complete. Enjoy your new ViewSonic LCD display.**

To be best prepared for any future customer service needs: print this user guide and write the serial number in "For Your Records" on page 4. (See back of LCD display.)

You can register your product online at the ViewSonic website for your region. See the Customer Support table in this guide.

The ViewSonic Wizard CD-ROM also provides an opportunity for you to print the registration form which you may mail or fax to ViewSonic.

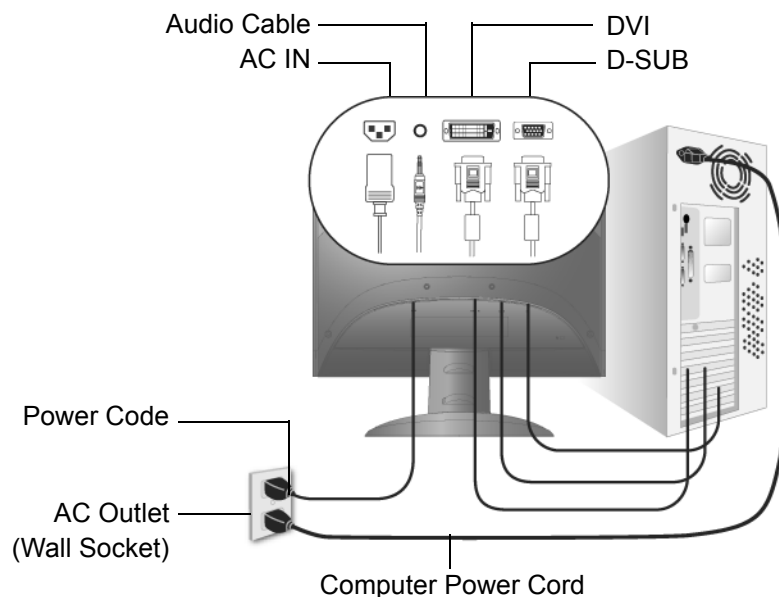



# ViewDock™ Connecting to PC

Use the supplied cables to connect the ViewDock to your PC.

Refer to the following illustration:

Step 1. Please check your USB cable (A-B type)

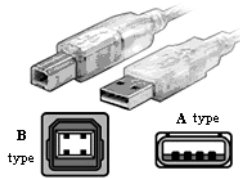

Step 2. Connect the USB cable from PC (A type) to the ViewDock (B type)

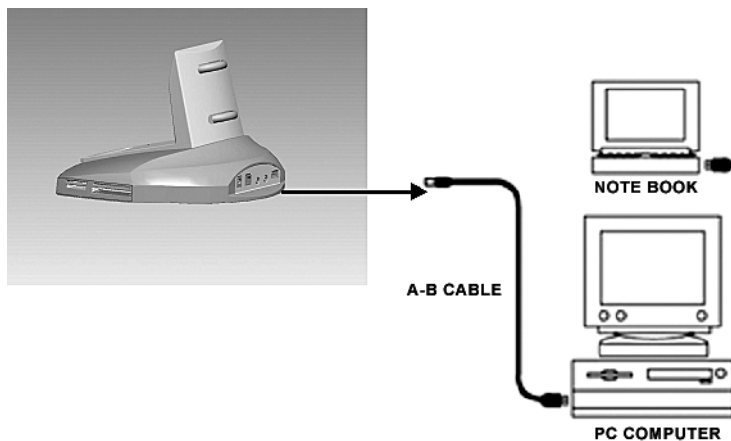

Step 3. Plug in the power adaptor into the DC jack.

Step 4. Connect the stereo audio cable from audio-out of ViewDock base to audio-in of monitor panel head.

Step 5. Connect the 2-in-1 audio cable from audio-in of ViewDock to audio-out / MIC-in of PC.

Step 6. Turn on the power.

## Wall Mounting (Optional)

To obtain a wall-mounting kit, contact ViewSonic® or your local dealer. Refer to the instructions that come with the base mounting kit. To convert your LCD display from a desk-mounted to a wall-mounted display, do the following:

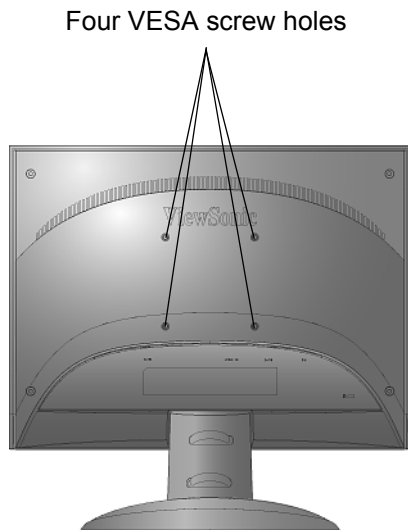

1. Verify that the Power button is turned Off, then disconnect the power cord.
2. Lay the LCD display face down on a towel or blanket.
3. Remove the Plastic Covers from the back of the LCD display.
4. Remove the four screws attaching the base.
5. Remove the Rubber Plugs from inside the four VESA screw holes.
6. Attach the mounting bracket from the VESA compatible wall mounting kit (100 mm x 100 mm distance).
7. Attach the LCD display to the wall, following the instructions in the wall-mounting kit.

# Using the LCD Display

## Setting the Timing Mode

Setting the timing mode is important for maximizing the quality of the screen image and minimizing eye strain. The **timing mode** consists of the **resolution** (example 1440 x 900) and **refresh rate** (or vertical frequency; example 60 Hz). After setting the timing mode, use the OSD (On-screen Display) controls to adjust the screen image.

For the best picture quality set your LCD display timing mode to:

**VESA 1440 x 900 @ 60Hz.**

To set the Timing Mode:

- 1. Set the resolution:** Right-click on the Windows desktop > Properties > Settings > set the resolution.
- 2. Set the refresh rate:** See your graphic card's user guide for instructions.

**WARNING:** Do not set the graphics card in your computer to exceed the maximum refresh rate of 75Hz; doing so may result in permanent damage to your LCD display.

## OSD and Power Lock Settings

- **OSD Lock:** Press and hold [1] and the up arrow ▲ for 10 seconds. If any buttons are pressed the message *OSD Locked* will display for 5 seconds.
- **OSD Unlock:** Press and hold [1] and the up arrow ▲ again for 10 seconds.
- **Power Button Lock:** Press and hold [1] and the down arrow ▼ for 10 seconds. If the power button is pressed the message *Power Button Locked* will display for 5 seconds. With or without this setting, after a power failure, your LCD display's power will automatically turn ON when power is restored.
- **Power Button Unlock:** Press and hold [1] and the down arrow ▼ again for 10 seconds.

# Adjusting the Screen Image

Use the buttons on the front control panel to display and adjust the OSD controls which display on the screen. The OSD controls are explained at the top of the next page and are defined in “Main Menu Controls” on page 12.

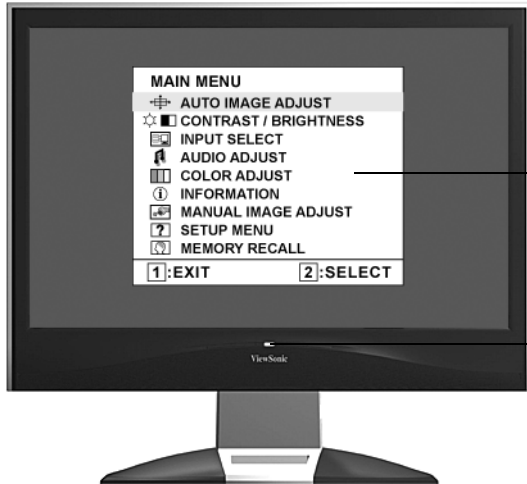

**Main Menu**  
with OSD controls

**Front Control Panel**  
shown below in detail

Displays the control screen for the highlighted control.  
Also toggles between two controls on some screens.  
Also a shortcut to Auto Image Adjust.

Displays the Main Menu or exits the control screen and saves adjustments.

Standby Power On/Off  
Power light  
Blue = ON  
Orange = Power Saving

Scrolls through menu options and adjusts the displayed control.  
Also a shortcut to display the Contrast adjustment control screen.

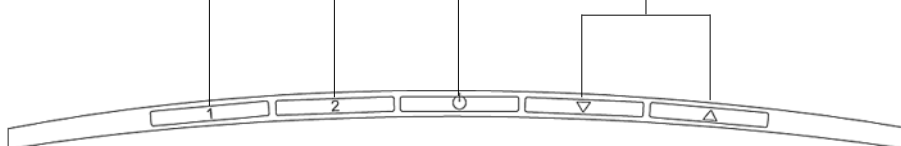

**Do the following to adjust the display setting:**

1. To display the Main Menu, press button [1].

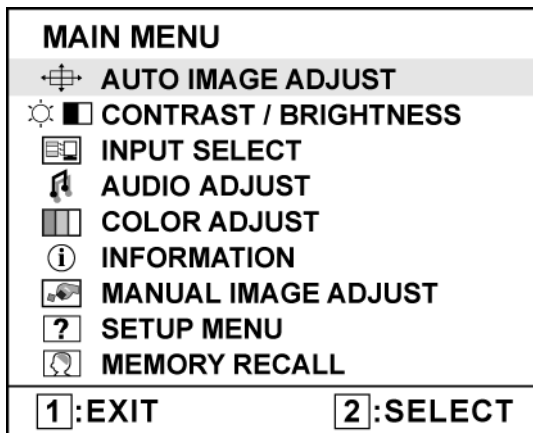

**NOTE:** All OSD menus and adjustment screens disappear automatically after about 15 seconds. This is adjustable through the OSD timeout setting in the setup menu.

2. To select a control to adjust, press▲or▼to scroll up or down in the Main Menu.
3. After the desired control is selected, press button [2]. A control screen like the one shown below appears.

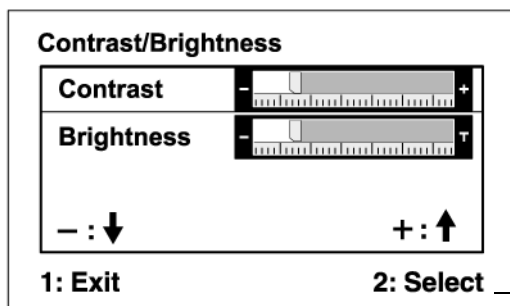

The command line at the bottom of the control screen tells what to do next from this screen. You can toggle between control screens, adjust the selected option, or exit the screen.







4. To adjust the setting, press the up ▲ or down ▼ buttons.
5. To save the adjustments and exit the menu, press button [1] *twice*.

**The following tips may help you optimize your display:**

- Adjust the computer's graphics card so that it outputs a 1440 x 900 @ 60Hz video signal to the LCD display. (Look for instructions on “changing the refresh rate” in the graphics card's user guide.)
- If necessary, make small adjustments using H. POSITION and V. POSITION until the screen image is completely visible. (The black border around the edge of the screen should barely touch the illuminated “active area” of the LCD display.)

# Main Menu Controls

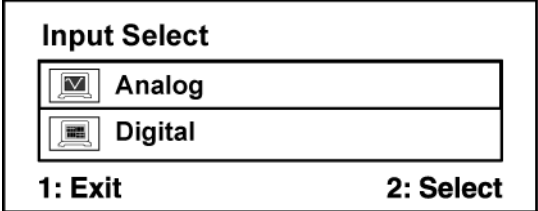
Adjust the menu items shown below by using the up ▲ and down ▼ buttons.

Control	Explanation
	<b>Auto Image Adjust</b> sizes and centers the screen image automatically.
	<b>Contrast</b> adjusts the difference between the image background (black level) and the foreground (white level).
	<b>Brightness</b> adjusts background black level of the screen image.
	<b>Input Select</b> toggles between inputs if you have more than one computer connected to the VX1945wm.
	
	<b>Audio Adjust</b> <b>Volume</b> increases the volume, decreases the volume, and mutes the audio. <b>Mute</b> temporarily silences audio output.
	<b>Color Adjust</b> provides several color adjustment modes, including preset color temperatures and a User Color mode which allows independent adjustment of red (R), green (G), and blue (B). The factory setting for this product is 6500K (6500 Kelvin).

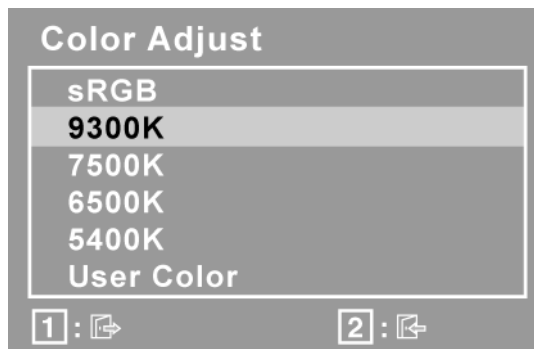

**sRGB**-This is quickly becoming the industry standard for color management, with support being included in many of the latest applications. Enabling this setting allows the LCD display to more accurately display colors the way they were originally intended. Enabling the sRGB setting will cause the Contrast and Brightness adjustments to be disabled.

**9300K**-Adds blue to the screen image for cooler white (used in most office settings with fluorescent lighting).

**7500K** - Adds blue to the screen image for cooler white (used in most office settings with fluorescent lighting).

**6500K**-Adds red to the screen image for warmer white and richer red.

**5400K**-Adds green to the screen image for a darker color.

**User Color** Individual adjustments for red (R), green (G), and blue (B).

1. To select color (R, G or B) press button [2].
2. To adjust selected color, press▲and▼.

**Important:** If you select RECALL from the Main Menu when the product is set to a Preset Timing Mode, colors return to the 6500K factory preset.



**Information** displays the timing mode (video signal input) coming from the graphics card in the computer, the LCD model number, the serial number, and the ViewSonic® website URL. See your graphics card's user guide for instructions on changing the resolution and refresh rate (vertical frequency).

**NOTE:** VESA 1440 x 900 @ 60Hz (recommended) means that the resolution is 1440 x 900 and the refresh rate is 60 Hertz.

Information		
H. Frequency:	XX	kHz
V. Frequency:	XX	Hz
Resolution:	XXX	
Pixel Clock:	XXXXXXXXXX	MHz
Serial Number:	XXXXXXXXXXXX	
Model Number:	XXXXXXXXXXXX	
www.ViewSonic.com		1: Exit



**Manual Image Adjust Sub-menu**

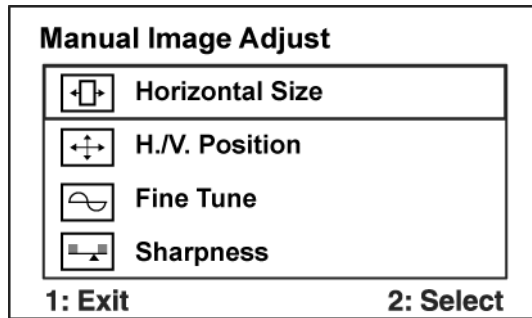

**H. Size (Horizontal Size)** adjusts the width of the screen image.



**H./V. Position (Horizontal/Vertical Position)** moves the screen image left or right and up or down.

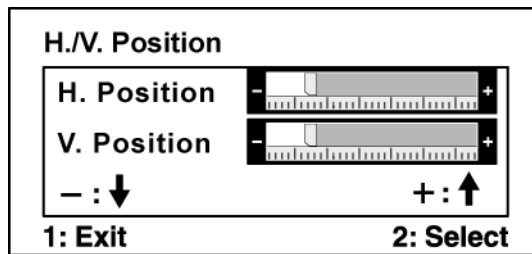

**Fine Tune** sharpens the focus by aligning text and/or graphics with pixel boundaries.

**NOTE:** Try Auto Image Adjust first.



**Sharpness** adjusts the clarity and focus of the screen image.



**Setup Menu** displays the menu shown below:

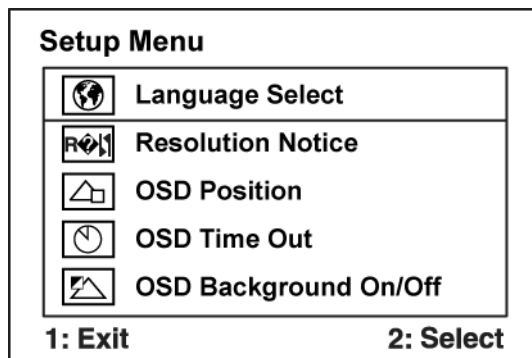

**Language Select** allows the user to choose the language used in the menus and control screens.





**Resolution Notice** allows the user to enable or disable this notice.

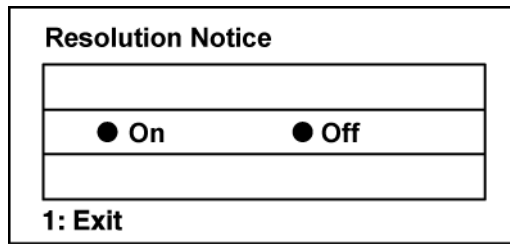

If you enable the Resolution Notice shown above and your computer is set at a resolution other than 1440 x 900, the following screen appears.

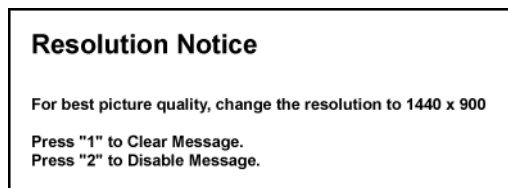

**OSD Position** allows the user to move the OSD menus and control screens.



**OSD Timeout** sets the length of time the OSD screen is displayed. For example, with a “30 second” setting, if a control is not pushed within 30 seconds, the display screen disappears.



**OSD Background** allows the user to turn the OSD background On or Off.



**Memory Recall** returns the adjustments back to factory settings if the display is operating in a factory Preset Timing Mode listed in the Specifications of this manual.

# ViewDock™ Key Features

## Features

The VX ViewDock comes with the following advanced features:

- 4-port USB 2.0 hub (USB 1.1 compatible)
- 8-in-1 card reader (SD, MMC, MS, MS Pro, CF I & II, MD, SMC)
- 3-watt subwoofer support
- iPod docking & charging
- Headphone jack and built-in microphone

## System requirements

For optimal use with the ViewDock, the computer should have the following minimum system requirements:

### Hardware requirements

- Pentium 200 CPU or higher
- CD-ROM for driver installation
- USB2.0/1.1 interface
- 32 MB memory

### Software Requirements

- Microsoft Windows 98SE/2000/ME/XP
- MAC OS 8.5+ or higher version.

# Physical Description

Please refer to the following illustrations to identify the components of the ViewDock.

## Front View

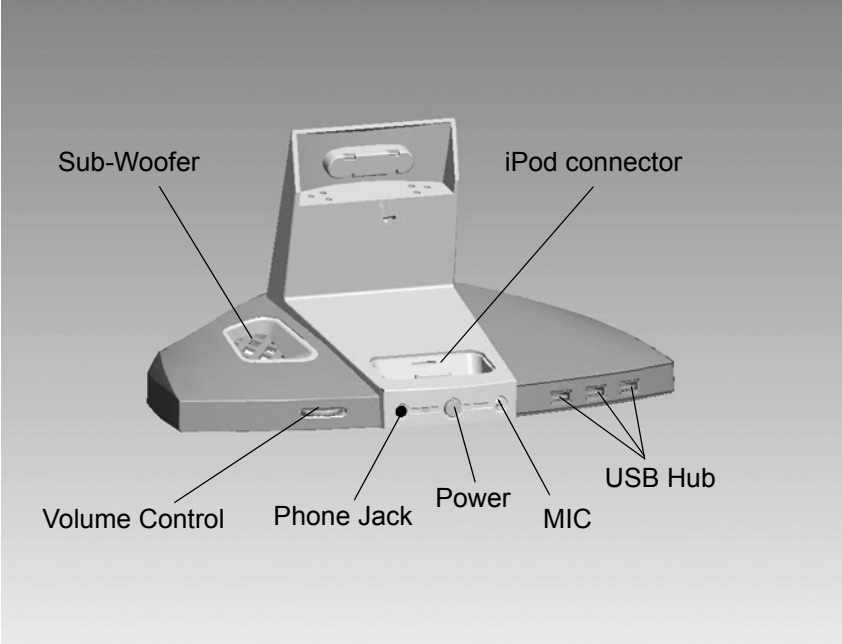

## Rear view

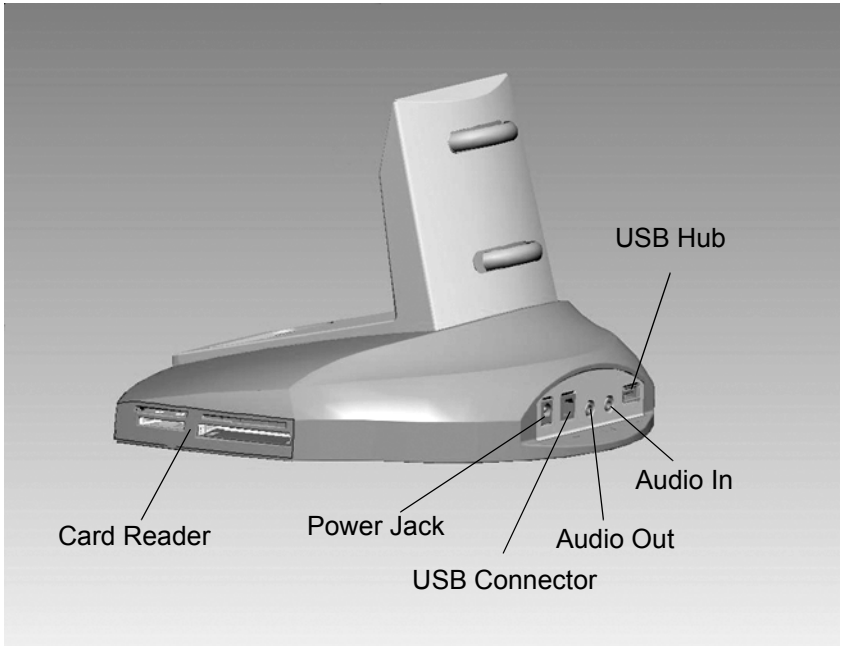

# Card Reader Installation

## Refer to the following information

After connecting the ViewDock to your PC, Windows File Manager will show 4 extra icons.

Step1. Please check your card socket

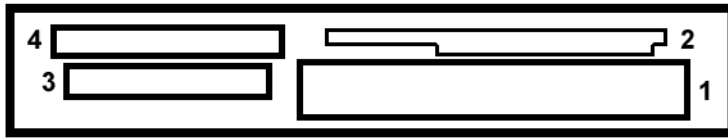

- |              |              |
|--------------|--------------|
| 1. CFI/II/MD | 3. MS/MS PRO |
| 2. SMC       | 4. SD/MMC    |

Step2. Insert your memory card. Each slot of the card reader will be recognized as a Removable Disk and the icon will be shown in "My Computer" of Windows

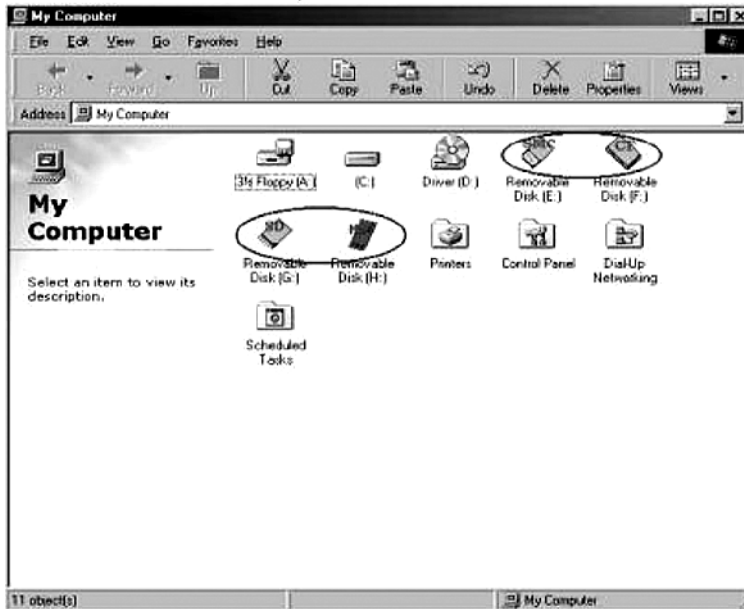

You do not need to install any special drivers for the Card Reader if your OS is Windows 2000/ME/XP.

## Card reader Installation guide for Windows 98SE :

(Please do not connect the ViewDock to your PC's USB port before running the CD):

1. Insert the driver CD into the CD-ROM
2. Please launch the .exe file and the driver will be installed automatically.
3. After completing installation, connect the ViewDock to your PC's USB port. The card reader is now operational.
4. Each slot of the card reader will be recognized as a Removable Disk and the icon will be shown in "My Computer."

# USB Hub Installation

Refer to the following information



Downstream port  
Connect to device  
Type A female

Connect any USB devices via the USB ports on the ViewDock.

Windows will auto detect and install the generic Windows USB driver for USB 1.1/2.0 device operation.

You do not need to install any special drivers for the USB Hub if your OS is Windows 2000/ME/XP.

## USB hub installation guide for Windows 98SE :

Insert the included CD into the CD-ROM drive. The Autorun feature will automatically begin the installation process. Follow the instructions on the screen to install the driver.

If the setup program does not start automatically, go to "My Computer" and double-click on the CD-ROM drive, and select "Setup.exe" from the CD.

**Note:** If USB device is not detected , does not work properly:

1. Double click the "System" icon in Control Panel.
2. Select the "Device Manager" tab from System Properties dialog window.
3. Select "Other devices" to see the contents.
4. Select "Unknown device" and click "Remove" button.
5. Click the "Refresh" button and system will find a new device.

# ViewDock™ Connecting with iPod

## Refer to the following information

1. Make sure the ViewDock power is ON.
2. Dock your iPod into the universal iPod docking station with the appropriate adapter insert.
3. The iPod LED indicator will turn on amber
4. Wait for a few seconds for the iTunes software to launch.
5. Play your favorite song with iTunes software (for all iPod models) or play music from iPod directly (excluding iPod shuffle.)



## iPod adapter insert description:

iPod with video adaptor is a default setting for multimedia base.

Adapter No.	Work with Ipod models
1.	iPod nano
2.	iPod mini (1st/ 2nd Generation)
3.	iPod Video iPod with color display (20G/U2) iPod with Click Wheel (20G/U2)
4.	iPod with color display (30G) iPod with dock connector (10/15/20G)
5.	iPod with color display (60G) iPod photo (40/60G) iPod with Click Wheel (40G) iPod with dock connector (30/40G)

## Subwoofer Volume Control

### Refer to the following information

1. Adjust subwoofer volume via volume control
2. "  " Turn right to increases the subwoofer volume.
3. "  " Turn left to decreases the subwoofer volume.
4. In order to obtain the optimum listening environment, please adjust the volume of stereo speakers in the monitor head via the monitor OSD menu to match and balance the subwoofer volume.



# Other Information

## Specifications

<b>LCD</b>	Type	19" (full 19" viewable diagonal area), TFT (Thin Film Transistor), Active Matrix WXGA LCD, 0.285 mm pixel pitch	
	Color Filter	RGB vertical stripe	
	Glass Surface	Anti-Glare	
<b>Input Signal</b>	Video Sync	RGB analog (0.7/1.0 Vp-p, 75 ohms) / TMDS Digital (100ohms) Separate Sync, f <sub>h</sub> :30-82 kHz, f <sub>v</sub> :50-85 Hz	
<b>Compatibility</b>	PC Macintosh <sup>1</sup>	Up to 1440 x 900 Non-interlaced Power Macintosh up to 1440 x 900	
<b>Resolution</b>	Recommended and supported	1440 x 900 @ 60, 75 Hz 1280 x 1024 @ 60, 70, 72 Hz 1024 x 768 @ 60, 70, 72, 75, 85 Hz 800 x 600 @ 56, 60, 72, 75, 85 Hz 640 x 480 @ 60, 75, 85 Hz 720 x 400 @ 70 Hz	
<b>Power</b>	Voltage	100-240 VAC, 50-60 Hz (auto switch)	
<b>Display area</b>	Full Scan	410.4 mm (H) x 256.5 mm (V) 16.2" (H) x 10.1" (V)	
<b>Operating conditions</b>	Temperature	41° F to + 95° F (5° C to + 35° C)	
	Humidity	20% to 80% (non-condensing)	
	Altitude	To 10,000 feet	
<b>Storage conditions</b>	Temperature	-4° F to + 131° F (-20° C to + 55° C)	
	Humidity	20% to 85% (non-condensing)	
	Altitude	To 40,000 feet	
<b>Dimensions</b>	Physical	450 mm (W) x 449 mm (H) x 212 mm (D) 17.7" (W) x 17.7" (H) x 8.4" (D)	
<b>Weight</b>	Physical	12.6 lb (5.7 kg)	
<b>Regulations</b>		BSMI, CCC, PSB, C-Tick, CE, VCCI, Ergo, Gost-R/Hygienic, SASO, MPR II, UL/cUL, FCC-B, ICES-B, NOM, TUV-S, ENERGY STAR <sup>®</sup>	
<b>Power saving modes</b>	On	Normal	(blue LED)
	Off	<1W	(orange LED)

**Preset Timing Mode** (pre-adjusted to VESA<sup>®</sup> 1440 x 900 @ 60 Hz)

**Warning:** Do not set the graphics card in your computer to exceed these refresh rates; doing so may result in permanent damage to the LCD display.

<sup>1</sup> Macintosh computers older than G3 require a ViewSonic<sup>®</sup> Macintosh adapter. To order an adapter, contact ViewSonic.

# Troubleshooting

## No power

- Make sure power button (or switch) is ON.
- Make sure A/C power cord is securely connected to the LCD display.
- Plug another electrical device (like a radio) into the power outlet to verify that the outlet is supplying proper voltage.

## Power is ON but no screen image

- Make sure the video cable supplied with the LCD display is tightly secured to the video output port on the back of the computer. If the other end of the video cable is not attached permanently to the LCD display, tightly secure it to the LCD display.
- Adjust brightness and contrast.
- If you are using an Macintosh older than G3, you need a Macintosh adapter.

## Wrong or abnormal colors

- If any colors (red, green, or blue) are missing, check the video cable to make sure it is securely connected. Loose or broken pins in the cable connector could cause an improper connection.
- Connect the LCD display to another computer.
- If you have an older graphics card, contact ViewSonic® for a non-DDC adapter.

## Control buttons do not work

- Press only one button at a time.



# Customer Support

For technical support or product service, see the table below or contact your reseller.

**NOTE:** You will need the product serial number.

Country/Region	Website	T = Telephone F = FAX	Email
United States	<a href="http://www.viewsonic.com/support">www.viewsonic.com/support</a>	T= 800 688 6688 F= 909 468 1202	<a href="mailto:service.us@viewsonic.com">service.us@viewsonic.com</a>
Canada	<a href="http://www.viewsonic.com/support">www.viewsonic.com/support</a>	T= 866-463-4775 F= 909-468-5814	<a href="mailto:service.ca@viewsonic.com">service.ca@viewsonic.com</a>
Latin America (Mexico/Chile)	<a href="http://www.viewsonic.com/support/">www.viewsonic.com/support/</a>	T= 866-323-8056 F= 909-444-5655	<a href="mailto:soporte@viewsonic.com">soporte@viewsonic.com</a>
United Kingdom	<a href="http://www.viewsoniceurope.com/uk">www.viewsoniceurope.com/uk</a>	T= 0207 949 0307	
Europe, Middle East, Baltic countries, and North Africa	<a href="http://www.viewsoniceurope.com">www.viewsoniceurope.com</a>	(Contact your reseller)	
Australia and New Zealand	<a href="http://www.viewsonic.com.au/support/">www.viewsonic.com.au/support/</a>	AUS= 1800 880 818 NZ= 0800 008 822	<a href="mailto:service@au.viewsonic.com">service@au.viewsonic.com</a>
Singapore/Malaysia/ Thailand	<a href="http://www.viewsonic.com.sg/support/">www.viewsonic.com.sg/support/</a>	T= 65 64616044	<a href="mailto:service@sg.viewsonic.com">service@sg.viewsonic.com</a>
South Africa and other countries	<a href="http://www.viewsonic.com">www.viewsonic.com</a>	T= 886 2 2246 3456 F= 886 2 2249 1751	<a href="mailto:service@sd.viewsonic.com">service@sd.viewsonic.com</a>
India	<a href="http://www.in.viewsonic.com">www.in.viewsonic.com</a>	T= 1800 11 9999	<a href="mailto:service@in.viewsonic.com">service@in.viewsonic.com</a>
Hong Kong	<a href="http://www.hk.viewsonic.com/support/">www.hk.viewsonic.com/support/</a>	T= 852 3102 2900	<a href="mailto:service@hk.viewsonic.com">service@hk.viewsonic.com</a>
Macau	<a href="http://www.hk.viewsonic.com/support/">www.hk.viewsonic.com/support/</a>	T= 853 700 303	<a href="mailto:service@hk.viewsonic.com">service@hk.viewsonic.com</a>
Korea	<a href="http://www.viewsonic.com">www.viewsonic.com</a>	T= 080 333 2131	<a href="mailto:service@kr.viewsonic.com">service@kr.viewsonic.com</a>

## Cleaning the LCD Display

- MAKE SURE THE LCD DISPLAY IS TURNED OFF.
- NEVER SPRAY OR POUR ANY LIQUID DIRECTLY ONTO THE SCREEN OR CASE.

### To clean the screen:

1. Wipe the screen with a clean, soft, lint-free cloth. This removes dust and other particles.
2. If the screen still not clean, apply a small amount of non-ammonia, non-alcohol based glass cleaner onto a clean, soft, lint-free cloth, and wipe the screen.

### To clean the case:

1. Use a soft, dry cloth.
2. If the case still not clean, apply a small amount of a non-ammonia, non-alcohol based, mild non-abrasive detergent onto a clean, soft, lint-free cloth, then wipe the surface.

### Disclaimer

- ViewSonic® does not recommend the use of any ammonia or alcohol-based cleaners on the LCD display screen or case. Some chemical cleaners have been reported to damage the screen and/or case of the LCD display.
- ViewSonic will not be liable for damage resulting from use of any ammonia or alcohol-based cleaners.

# Limited Warranty

## VIEWSONIC® LCD DISPLAY

### What the warranty covers:

ViewSonic warrants its products to be free from defects in material and workmanship, under normal use, during the warranty period. If a product proves to be defective in material or workmanship during the warranty period, ViewSonic will, at its sole option, repair or replace the product with a like product. Replacement product or parts may include remanufactured or refurbished parts or components.

### How long the warranty is effective:

ViewSonic LCD displays are warranted for 3 years for all parts including the light source and 3 years for all labor from the date of the first consumer purchase.

### Who the warranty protects:

This warranty is valid only for the first consumer purchaser.

### What the warranty does not cover:

1. Any product on which the serial number has been defaced, modified or removed.
2. Damage, deterioration or malfunction resulting from:
  - a. Accident, misuse, neglect, fire, water, lightning, or other acts of nature, unauthorized product modification, or failure to follow instructions supplied with the product.
  - b. Repair or attempted repair by anyone not authorized by ViewSonic.
  - c. Any damage of the product due to shipment.
  - d. Removal or installation of the product.
  - e. Causes external to the product, such as electrical power fluctuations or failure.
  - f. Use of supplies or parts not meeting ViewSonic's specifications.
  - g. Normal wear and tear.
  - h. Any other cause which does not relate to a product defect.
3. Any product exhibiting a condition commonly known as "image burn-in" which results when a static image is displayed on the product for an extended period of time.
4. Removal, installation, and set-up service charges.

### How to get service:

1. For information about receiving service under warranty, contact ViewSonic Customer Support (Please refer to Customer Support page). You will need to provide your product's serial number.
2. To obtain warranted service, you will be required to provide (a) the original dated sales slip, (b) your name, (c) your address, (d) a description of the problem, and (e) the serial number of the product.
3. Take or ship the product freight prepaid in the original container to an authorized ViewSonic service center or ViewSonic.
4. For additional information or the name of the nearest ViewSonic service center, contact ViewSonic.

### Limitation of implied warranties:

There are no warranties, express or implied, which extend beyond the description contained herein including the implied warranty of merchantability and fitness for a particular purpose.

### Exclusion of damages:

ViewSonic's liability is limited to the cost of repair or replacement of the product. ViewSonic shall not be liable for:

1. Damage to other property caused by any defects in the product, damages based upon inconvenience, loss of use of the product, loss of time, loss of profits, loss of business opportunity, loss of goodwill, interference with business relationships, or other commercial loss, even if advised of the possibility of such damages.
2. Any other damages, whether incidental, consequential or otherwise.
3. Any claim against the customer by any other party.

### Effect of state law:

This warranty gives you specific legal rights, and you may also have other rights which vary from state to state. Some states do not allow limitations on implied warranties and/or do not allow the exclusion of incidental or consequential damages, so the above limitations and exclusions may not apply to you.

### Sales outside the U.S.A. and Canada:

For warranty information and service on ViewSonic products sold outside of the U.S.A. and Canada, contact ViewSonic or your local ViewSonic dealer.

The warranty period for this product in mainland China (Hong Kong, Macao and Taiwan Excluded) is subject to the terms and conditions of the Maintenance Guarantee Card.

