

OWNER'S MANUAL

MODEL NO.'S

CS-694

CS-1094

CSP-694

CSP-1094



CAUTION

For Operation
Read Rules And
Instructions Carefully



Broadcast Seeder/Spreader PTO DRIVEN – 3-PT. MOUNTED

Packing
Assembly & Mounting
Operating Instructions

Maintenance
Repair Parts

STATEMENT OF POLICY

It is the policy of **Work saver, Inc.** to improve its products where it is possible and practical to do so. **Work saver, Inc.** reserves the right to make changes or improvements in design and construction at any time without incurring the obligation to make these changes on previously manufactured units.



ATTENTION! SAFETY RULES

1. Read instruction manual and make sure all operators are knowledgeable on correct operation of equipment and familiar with the Safety Rules of Operation.
2. Never allow riders on equipment.
3. When operating on rough or uneven terrain, use extreme caution and a safe operating speed.
4. When spreading seed or fertilizer, always use safety goggles.
5. Never operate equipment when anyone is within 50 feet of seeder/spreader.

BEFORE OPERATING EQUIPMENT: If you have any questions regarding the proper assembly or operation, contact your dealer or representative.

WORKSAVER, INC.

P.O. Box 100, Litchfield, IL. 62056-100

Phone: 217-324-5973 Fax: 217-324-3356

Web Site: www.worksaver.com E-mail: sales@worksaver.com

To the Owner/Operator/Dealer

All implements with moving parts are potentially hazardous. There is no substitute for a cautious, safe-minded operator who recognizes the potential hazards and follows reasonable safety practices. The manufacturer has designed this implement to be used with all its safety equipment properly attached, to minimize the chance of accidents.

BEFORE YOU START!!

Read the safety messages on the implement and shown in your manual. Observe the rules of safety and common sense!

Instructions

TRACTOR REQUIREMENTS & PREPARATION

The 3-pt. mounted broadcast seeder/spreader with a PTO drive will fit most Categories I and some larger Category 0 tractors. Larger Category II tractors may also be used if the 3-pt. hitch lift arms will narrow to 26 inches. Bushings will be needed to fit the Category I (7/8" dia.) lift pins.

NOTE: Some Category 0 tractors have very short lift arms or 5/8" diameter (Cat. 0) lift arm ball ends. These tractors are not usually suitable.

Check the tractor's 3-pt. hitch. The hitch hydraulic system should be able to hold the lift arms at a set height. If the hydraulic system leaks and allows the lift arms to drop, then use stay straps to lock the hitch into position.

Refer to your operator's manual or dealer for any adjustments necessary to put the 3-pt. hydraulic lift system in good working order. (I&T shop manuals will list most specifications and adjustment instructions – available from most farm equipment dealers.)

NOTE: The Model CS-694 Seeder/Spreaders weighs 123 pounds and can hold up to 600 pounds of fertilizer. The tractor needs to be large enough to handle this possible 723-pound load safely. The tractor may have to be equipped with front-end weights to be properly counterbalanced.

Check the shield over the PTO stub shaft. Make sure it is in good condition and bolted securely to the tractor. Purchase a new shield if old shield is damaged or missing.



CAUTION!



Be sure your tractor is in good condition. Read all the safety precautions and make sure all tractor operators are familiar with the safety rules of operation.

PACKING

The CS-94 series of seeder/spreaders are shipped assembled, except for the PTO drive shaft.

ASSEMBLY & MOUNTING

Mount the seeder on your tractor by sliding the lift arm ball sockets over the seeder pull pins and secure with linchpins (not furnished). Attach the center link (not furnished) to the center link bracket on the seeder using a center link pin (not furnished), and secure it with a suitable linchpin. Adjust the center link so that the seeder fan is parallel to the ground.

NOTE: Use stabilizer bars, adjustable sway chains, or sway blocks on your tractor lift arms to keep the seeder/spreader from swinging side to side. Adjust as tightly as practical for best performance.

PTO INSTALLATION

In some cases it may be necessary to shorten the PTO assembly to match your particular tractor. The following procedure should be used:

(REFER TO FIG. 1)

Raise the tractor 3-pt. hitch so the input shaft of the spreader gearbox is in line with the PTO shaft on the tractor.

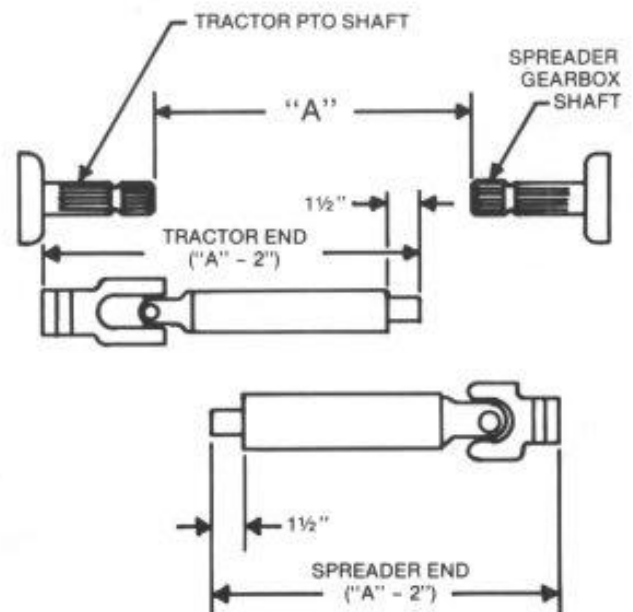

FIGURE 1

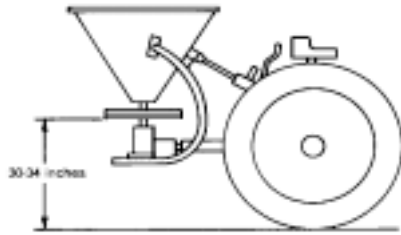

FIGURE 2

Measure the distance between the ends of the two shafts (Dimension "A", Figure 1). Each half of the PTO should be equal to dimension "A" minus two (2) inches.

If the driveline must be cut to a shorter length, clamp driveline in a well-padded vise to prevent damage to the shield (Figure 3). Cut the plastic shields 1 ½ shorter than the shafts.

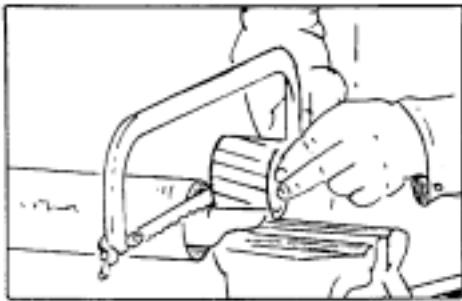

FIGURE 3

Repeat the procedure to the other driveline half. Remove all burrs and cuttings.

Apply multi-purpose grease to inside of outer (female) driveline section. Assemble driveline and install on tractor and spreader. Pull on each driveline section to be sure yokes lock into place. Make certain driveline shielding is in place and in good condition.

NOTE: A PTO driveline that is too long and "bottoms out" could possibly cause severe damage to the gearbox. It is VERY IMPORTANT to check the proper PTO driveline length for your tractor. Gearboxes damaged by incorrect PTO driveline length are NOT covered by warranty.

NOTE: The use of a PTO shaft adapter or extension could require that the PTO driveline be shortened a considerable amount. If this is done, the driveline halves may separate when the spreader is lowered to the ground.



Do not operate this equipment without shields properly installed. This is for your protection, and the manufacturer recommends the use of these shields at all times.



When attaching PTO yoke to tractor PTO shaft, it is important that spring-activated locking pin slides freely and is seated in groove on PTO shaft. A loose shaft could slip off and result in personal injury or damage to equipment.

If your tractor has extra long lift arms, it may be necessary to use a PTO extension so that you can use the PTO shaft assembly provided. Be sure the PTO assembly does not close too far (bottom out) if you use a PTO extension.

Never raise or lower the seeder/spreader so that the PTO shaft assembly will come apart.



A heavy load can cause instability in driving a tractor. Make sure the front of the tractor is properly counter-balanced with weights. Always drive slowly – especially around turns. An unstable tractor could steer badly and possibly tip over, causing injury or death.

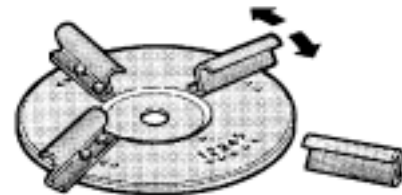

FIGURE 4

Fertilizers will vary as to weight and quality, which may require additional adjustment by moving the individual fan blades. Moving the blade tips forward will carry more material to the left side. Moving the fan blade tips back will allow more material to be spread to the right.

Make small adjustment moves and check spread after each adjustment.

NOTE: The gearbox is filled with lubricant and sealed at the factory. If operated and stored properly, the gearbox will provide a long, trouble-free service life. If disassembly of the gearbox should ever be required, it is important that the box be re-filled with a good quality grease and that the box halves are resealed with a silicone adhesive.

Obey All Safety Warnings!

OPERATING INSTRUCTIONS

1. Right-hand or left-hand reference is determined by standing at the rear of the seeder/spreader and facing in the direction of travel of the tractor.
2. Check the register of the control lever indicator with the seed gate (material gate). With the seed gate closed, the control lever should be in its fully raised position. Control lever setting listed on the spread charts are to the TOP of the control lever.

The adjustable pointer/stop below the control lever will point to a different setting as follows:

Top Side of Control Lever	2	3	4	5
Pointer/Stop Reading	4.5	4.75	6	7.25

3. **DO NOT FILL HOPPER** (especially with fertilizer) and transport over long distances, as it may result in packing, causing poor or erratic discharge.
4. **FOR BEST RESULTS** use palletized fertilizer, as it has little tendency to lump and causes little or no dust.
5. Be sure to sift or break up lumps found in some types of granular fertilizer before filling hopper.
6. Do not use on windy days, especially when spreading fine grass seed.
7. Be extremely careful if you are spreading herbicides, as there is the possibility of wind drift or overthrow into areas where serious crop/shrub damage could occur. Always follow instructions on chemical package.
8. Raise the seeder/spreader up so the spreader fan is 30-34 inches above the ground. This will give you the best spreading performance. It is also best if the seeder/spreader is tilted slightly forward so that the spreader fan throws slightly upward. (Use the top link to make this adjustment). The PTO shaft assembly should not be at a sharp angle – it should operate fairly straight or level.
9. Adjust the tension on the control handle so it moves with some resistance, but will remain where you set it. Adjust the control handle stop so that at the end of the field you can shut the seed gate and, after your turn, re-open to your exact setting.
10. If, by chance, the agitator does become jammed, open the feed gate all the way. By sticking a small rod through the feed gate, the material jamming the agitator can be loosened and removed. After the jam is cleared, reset the feed gate and proceed. Always stop tractor and disengage PTO before dislodging material.



CAUTION!



Do not attempt to use your fingers to clear a jam. Accidental closing of the feed gate could shear a finger off, or leaving the PTO engaged could rotate the agitator, which could pinch or amputate a finger. Be sure that the tractor engine is shut off and the PTO clutch is disengaged before doing any adjustment or repair.

11. When broadcasting fertilizer, always start vehicle in motion before opening feed gate. (Do not allow vehicle to sit stationary with feed gate open). If fertilizer is accidentally deposited too heavily in a small area, soak down thoroughly with garden hose or sprinkler to prevent burning.

SPREADING INSTRUCTIONS

1. The control handle regulates the opening in the hopper bottom. The calibrated scale determines the size of the opening. Place the control lever at the desired setting.
2. The spread chart in this manual is an approximate guide based on various forward speeds (from 4 mph to 7.5 mph). For accurate spreading, calibrate your tractor to operate at the desired speed. A calibrated speedometer is the best and most accurate. If your tractor does not have a speedometer or its accuracy is questionable, then you may calibrate in the following manner:

Set out two markers 88 feet apart. Select proper gear and adjust throttle speed to give the following travel time as shown between the markers. **NOTE:**

You cannot adjust the throttle very much, as you need to maintain 540 rpm PTO speed. (A plus or minus 20 rpm could be tolerated).

- 1 MPH will travel 88 feet in 60 seconds
- 4 MPH will travel 88 feet in 15 seconds
- 5 MPH will travel 88 feet in 12 seconds
- 6 MPH will travel 88 feet in 10 seconds
- 7.5 MPH will travel 88 feet in 8 seconds

After selecting gear and throttle setting to give desired speed, mark the throttle position in some convenient manner. Check PTO speed to make sure it is near 54 rpm.

3. Check rate chart for suggested setting for material type to be spread.
4. You are now ready to make a trial run to assure accurate results. Close the feed gates and put in a pre-determined amount of material to be spread. Spread this and check the results. Make final adjustments to obtain desired results.



CAUTION!



KEEP ALL PERSONS AWAY FROM THE ROTATING SPREADER FAN AND THE PTO SHAFT! NEVER OPERATE WHEN ANYONE IS WITHIN 50 FEET OF SEEDER/SPREADER

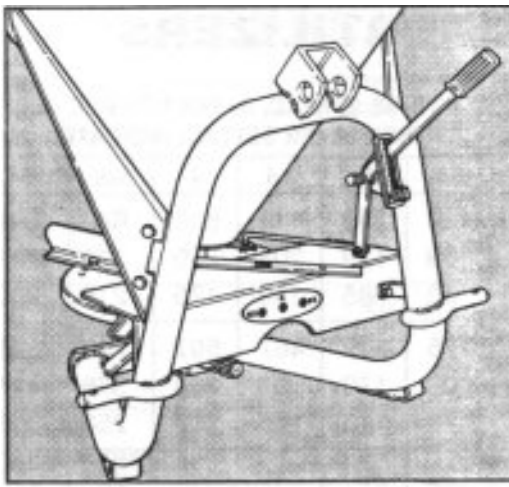

Three spreading possibilities

A simple adjustment of the lower level allows directioning of distribution towards the right side or towards the left side of the tractor operator.

MAINTENANCE

1. The hopper should be washed after use, especially after use with corrosive material such as fertilizer, salt, or ice melting compounds. When dry, oil thoroughly.
2. The gearbox is filled with lubricant and sealed at the factory. If operated and stored properly, the gearbox will provide a long, trouble-free service life. If disassembly of the gearbox should ever be required, it is important that the box be re-filled with a good quality grease and that the box halves are resealed with a silicone adhesive.
3. Grease PTO universal joints after every 8 hours of operation. Lubricate steel tube and shaft so they telescope freely.
4. Always store seeder/spreader in a clean, dry place.
5. Before using, check to make sure all nuts and bolts are tight.
6. Paint any bare metal or rusty spots for longer life.

HELPFUL

TROUBLE-SHOOTING TIPS

1. NOT FEEDING EVEN

- A. Seed gate opening may be set too close for the material being spread. To overcome, set the opening larger and drive faster to obtain same spread rate.
- B. Check material for foreign matter.
- C. Check agitator drive pin for shear.

2. POOR SPREAD

- A. Too much speed (over 560 PTO rpm) can cause uneven spread.
- B. PTO speed too slow (PTO rpm under 520 rpm) will result in a narrow spread.
- C. Bent fan blades.
- D. Drive pin sheared or missing on fan hub.
- E. Too windy for material being spread.
- F. Agitator problems. Check tips under "Not Feeding Even".
- G. Operator not spacing spread runs properly for correct overlap.
For best results, cover area twice over at one-half recommended material usage rate. The second time over, run halfway between first spreading widths or in a criss-cross pattern. This method allows the most complete and even coverage, as well as to give operator a chance to adjust gate setting to compensate for too thin or too heavy a covering the first time over.
- H. Seeder/spreader should run level or tilted slightly forward. Make sure lift arms on tractor are adjusted so one side is not lower than the other.
- I. Running agitator when not spreading can result in material being ground up and possibly packing over control gate opening. You can "over-agitate" material.



The CS-94 Series of seeder/spreaders have a two blade knife type agitator as standard equipment. An optional long wheel type agitator is available which will take care of air pockets in the hopper, mix up the material, and deliver it to the bottom knife type agitator. Order part number 420758 for the optional long wheel agitator.

This optional agitator is recommended for use when spreading powdery fertilizer, salt and sand. It may cause seed damage if used on grass seed or grain.

SPREADING CHART FOR FERTILIZERS

FERTILIZER TYPE	PTO SPEED (RPM)	SPREAD WIDTH IN FEET	TRACTOR SPEED (MPH)	QUANTITY TO BE SPREAD, IN POUNDS PER ACRE AT CONTROL LEVER SETTING INDICATED								
				1.5	2	2.5	3	3.5	4	4.5	5	5.5
Coarse Grain Fertilizers	540	40	2.5		97	139	246	414	516	640	789	935
			5		48	69	129	204	260	320	392	472
			7.5		37	53	85	139	175	218	260	323
Medium Grain Fertilizers	540	34	2.5	85	122	175	329	467	597	739	825	945
			5	51	73	105	170	236	303	376	417	478
			7.5	43	62	73	113	163	198	253	286	325
Fine Grain Fertilizers	540	26	2.5	60	85	122	204	340	440	551	647	770
			5	32	46	61	108	178	224	280	324	396
			7.5	21	30	41	93	122	153	193	220	263
Ammonium Nitrate	540	33	2.5		61	226	377	563	724	896	1052	1242
			5		28	116	190	284	366	448	525	622
			7.5		23	74	124	191	244	298	352	422
Urea (Carbamide)	540	28	2.5	77	110	303	458	669	818	1004	1171	
			5	41	59	150	231	300	411	500	590	
			7.5	26	37	100	150	221	275	336	392	

NOTE:

Spread widths of fertilizer will vary according to type.
Always check actual spread width and application rate.

NOTE:

Spread Chart settings are approximate – always make trial run to check actual application rate.

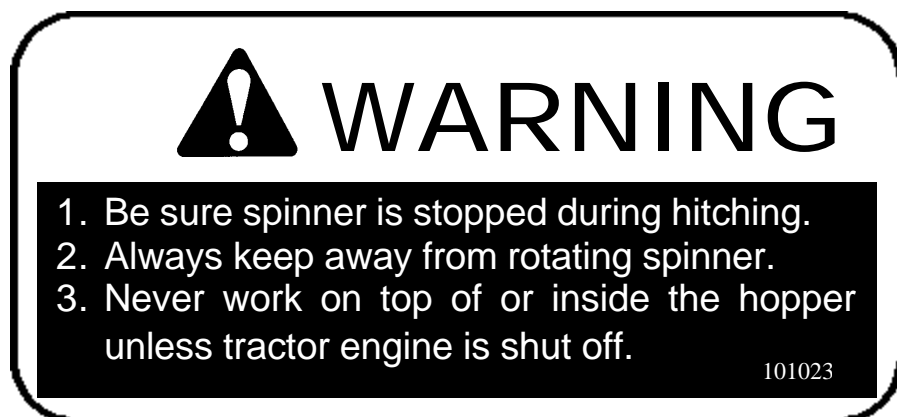

SPREADING CHART FOR SEED

MATERIAL	SPREAD WIDTH IN FEET	TRACTOR SPEED (MPH)	POUNDS PER ACRE (APPROXIMATE) AT CONTROL LEVER SETTING INDICATED							
			1.5	2	2.5	3	3.5	4	4.5	5
Alfalfa & Clover	26	4	14	48	118					
		5	11	39	95					
		6	9	32	79					
		7.5	7.5	26	63					
Barley	28	4				90	107	151	186	
		5				72	86	121	149	
		6				60	71	100	124	
		7.5				48	57	81	99	
Bluegrass & Bermuda Grass	18	4		20.5	72					
		5		16.5	45					
		6		13.5	36					
		7.5		11	24					
Brome Grass	10	4		7	12	19				
		5		6	9.5	15				
		6		5	8	12				
		7.5		4	6	10				
Fescue & Ryegrass	18	4		11	34	74				
		5		9	27	59				
		6		7.5	22	49				
		7.5		6	18	39				
Lespedeza	32	4	5	11	22					
		5	3.5	9	18					
		6	3	7.5	15					
		7.5	2.4	6	12					
Oats	28	4			45	71	131			
		5			36	57	105			
		6			30	48	87			
		7.5			24	38	70			
Orchard Grass	12	4		14	21					
		5		11	17					
		6		9	14					
		7.5		7	11					
Rice	33	4			87	140	253			
		5			70	112	203			
		6			58	93	169			
		7.5			47	75	135			
Rye	33	4			86	135	186	227		
		5			69	109	149	182		
		6			57	90	124	151		
		7.5			46	72	99	121		
Sudan Grass	33	4		37	58	92				
		5		30	47	74				
		6		25	39	61				
		7.5		20	31	49				
Soybeans	40	4					127	150	170	200
		5					102	120	136	160
		6					85	100	113	133
		7.5					68	80	90	106
Wheat	33	4			70	111	151	198		
		5			56	89	121	159		
		6			46	74	100	147		
		7.5			37	59	80	106		

NOTE: Spread Chart settings are approximate – always make a trial run to check actual application rate.

NOTE: Material can vary as to density, foreign material content, particle size and shape. These factors will affect both spread width and flow rate.

EXPLODED PARTS DRAWING FOR CS SERIES SPREADERS

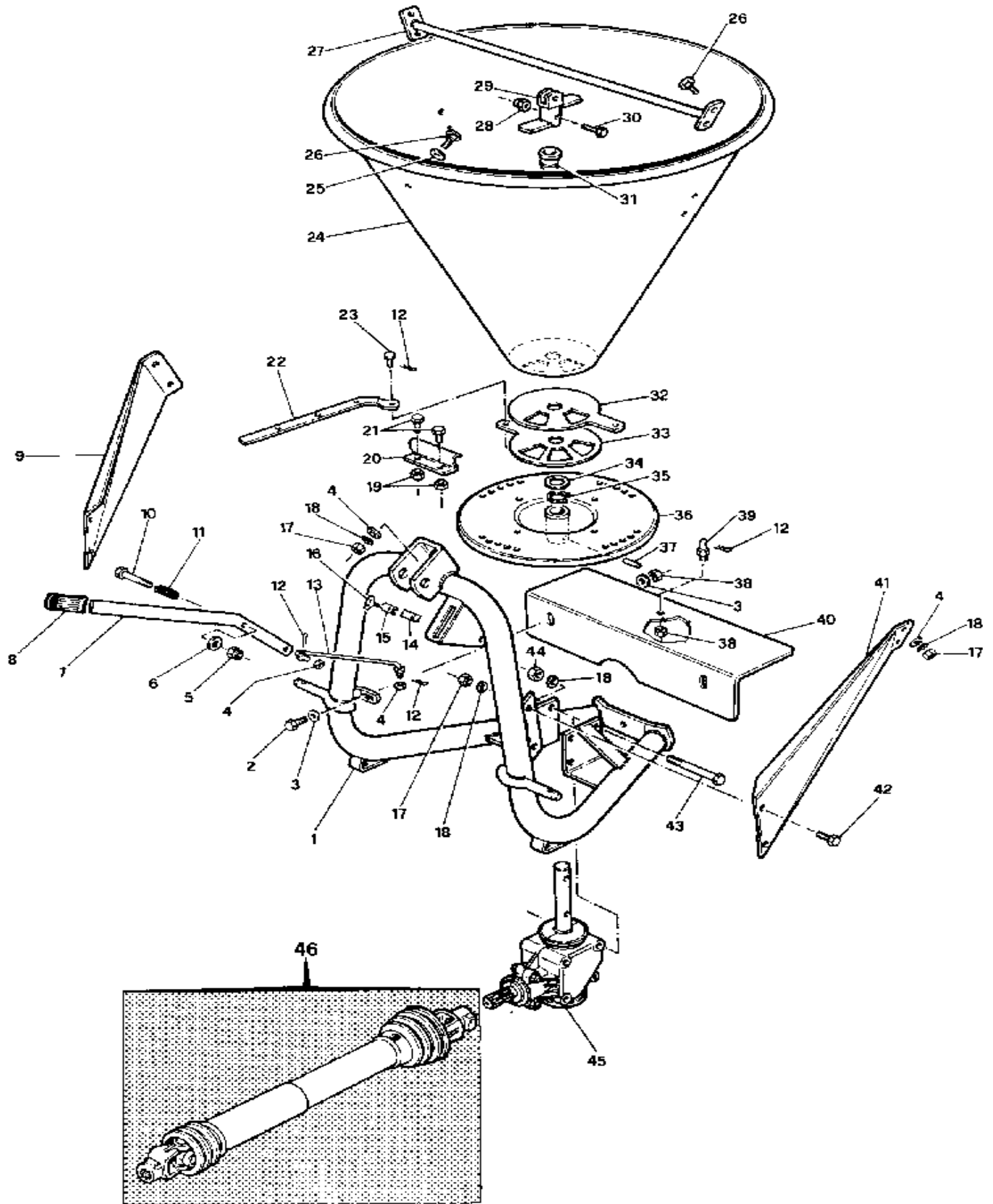

REPAIR PARTS FOR CS SERIES SEEDER/SPREADERS

Ref. No	Part No.	Description	No. Req'd
1	420701	Frame, XA	1
2	420702	Bolt, Hex Head, M8 x 20, Zinc	2
3	420703	Washer, Flat, 8mm, Zinc	4
4	420704	Washer, Flat, 10mm, Zinc	7
5	420705	Nut, Self-Locking, M10, Zinc	1
6	420706	Washer, Bakelite	1
7	420707	Lever, Adjustment	1
8	420708	Handle, Rubber, 8 x 20	1
9	420709	Brace, Right	1
10	420710	Bolt, Hex Head, m10 x 65, Zinc	1
11	420711	Spring, Pressure	1
12	420712	Hair pin	4
13	420713	Rod, Flow Adjustment	1
14	420714	Block, Fixing	1
15	420715	Indicator	1
16	420716	Screw, Wing, M6 x 16, Zinc	1
17	420717	Nut, Hex, M10, Zinc	9
18	420718	Washer,, Lock, 10mm, Zinc	12
19	420719	Nut, Hex, M8	8
20	420720	Vane, Fan	4
21	420721	Bolt, Hex Head, M8 x 16	8
22	420722	Rod, Selector, RX-LX	1
23	420723	Pin, Connection	1
24	420724	Hopper, Steel 250 (6 bu.)	1
24	420758	Hopper, Steel 400 (10 bu.)	1
24	420726	Hopper, Poly 400 (10 bu.)	1
24	420841	Hopper, Poly 250 (6 bu.)	1
25	420727	Washer, for Hopper	1
26	420728	Bolt, Carriage Head, M10 x 25, Zinc	5
27	420729	Bar, Hopper Reinforcement	1
28	420730	Nut, Self-locking, M8, Zinc	1
29	420731	Agitator	1
30	420732	Bolt, Hex Head, M8 x 45, Zinc	1
31	420733	Guide Bushing, Agitator	1
32	420734	Seed Disc, Upper (2 holes)	1
33	420735	Distribution Disc, Lower (3 holes)	1
34	420736	Washer, Special	1
35	420737	Snap Ring, D.32 E	1
36	420738	Spreading Disc (Spinner)	1
37	420739	Roll Pin (Special Double)	1
38	420719	Nut, Hex, M8, Zinc	3
39	420741	Pin, Adjustment	1
40	420742	Guard	1
41	420743	Brace, Left	1
42	420744	Bolt, Hex, M10 x 25, Zinc	4
43	420745	Bolt, Hex, M10 x 100, Zinc	3
44	420717	Nut, Hex, M10, Zinc	3
45	420747	Gearbox, 3-Hole (Complete)	1
46	420748	PTO Assembly (Complete)	1

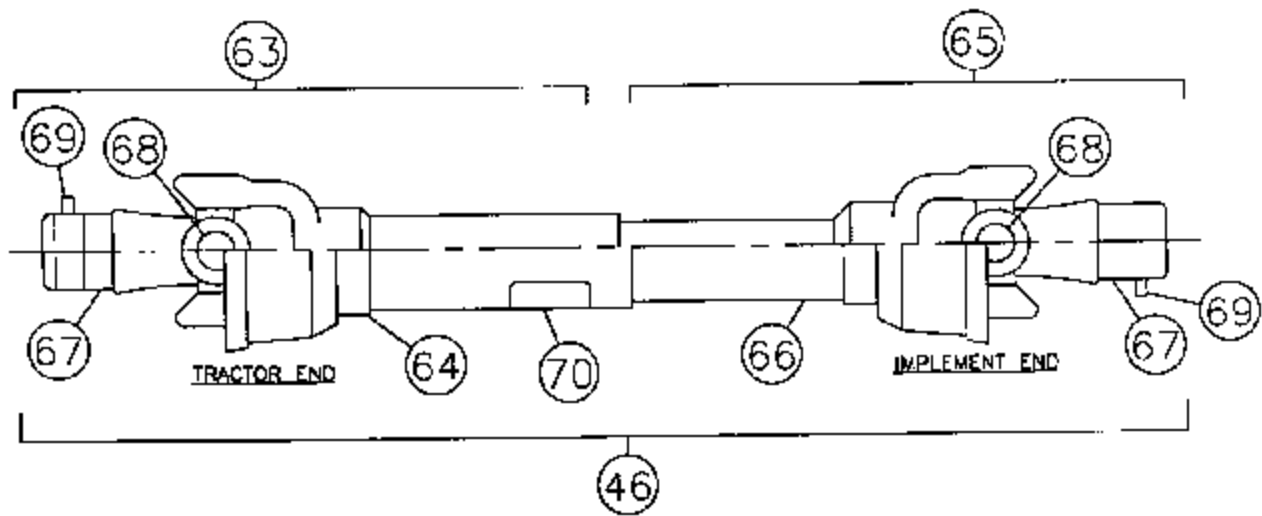

PTO COMPONENTS

Ref. No	Part No.	Description	No. Req'd
46	420748	PTO Assembly, Complete	1
63	420764	PTO Half, Tractor End	1
64	420765	Plastic Shield Assembly, Outer	1
65	420766	PTO Half, Implement End	1
66	420767	Plastic Shield Assembly, Inner	1
67	170804	Yoke, 1-3/8-6B Spline	2
68	3814091	PTO Cross Repair Kit	2
69	170806	Push Pin Repair Kit, Yoke	2
70	101081	Decal, Driveline Entanglement	1

GEARBOX COMPONENTS

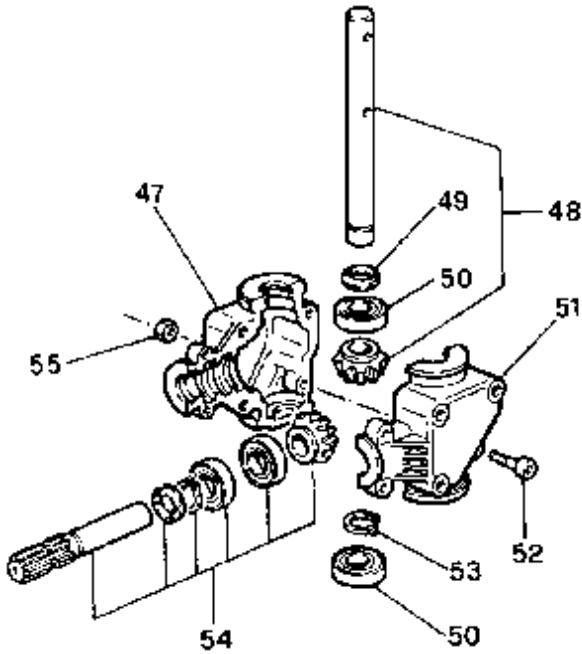

Ref. No.	Part No.	Description	NO. REQ.
45	420747	Gearbox, 3-Hole (Complete)	1
47	420749	Gearbox Half, Right Hand	1
48	420750	Shaft, Output Assembly	1
49	420751	Oil Seal, 25 x 37 x 5	1
50	420752	Bearing, 6205	2
51	420753	Gearbox Half, Left Hand	1
52	420754	Bolt, Hex Head, M8 x 45	3
53	420755	Snap Ring, D.25 E	1
54	420756	Shaft, Input Assembly	1
55	420719	Nut, Hex, M8	3

OPTIONAL AGITATOR COMPONENTS

Ref. No.	Part No.	Description	NO. REQ.
56	420725	Agitator, Complete	1
57	420759	Wheel, Agitator	1
58	420760	Washer, Flat, M12	2
59	420761	Nut, Self-Locking, M12, Zinc	1
60	420710	Bolt, Hex Head, M10 x 65, Zinc	1
61	420717	Nut, Hex, M10, Zinc	1

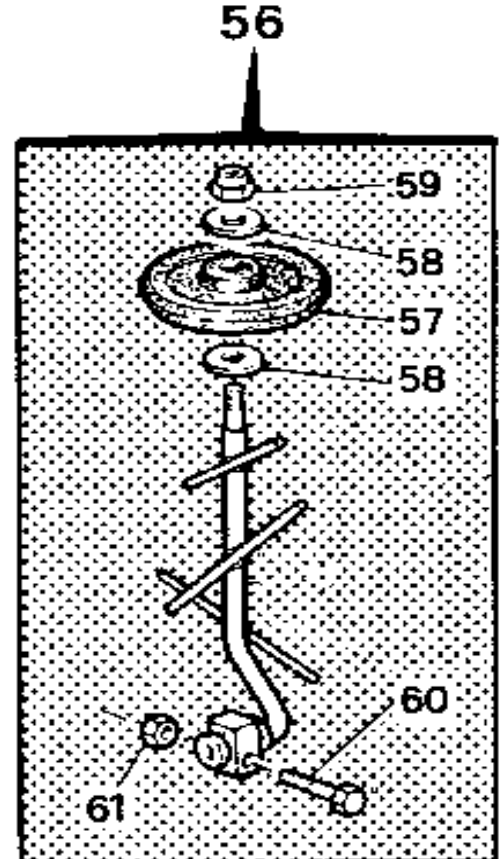



SAFETY PRECAUTIONS

MOST ACCIDENTS OCCUR BECAUSE OF NEGLIGENCE OR CARELESSNESS.

AVOID NEEDLESS ACCIDENTS BY FOLLOWING ALL OF THE SAFETY PRECAUTIONS LISTED BELOW.

1. Machinery should be operated only by those who are responsible and are authorized to do so.
2. Stop the engine, lower all equipment, lock the brakes, and remove the ignition key before dismounting from the tractor.
3. Never stand between tractor and implement while tractor is being backed to hitch.
4. Loose fitting clothing should not be worn, to avoid catching on various parts.
5. Detach implement in area where children normally do not play.
6. When performing adjustments or maintenance on an implement, first lower it to the ground or block it securely at a workable height.
7. Only a qualified operator should be permitted on tractor when in operation; no riders allowed.
8. Make certain everyone is in the clear before starting tractor or raising or lowering equipment.
9. Operate the tractor and implement only while seated in the driver's seat.
10. Reduce speed when transporting mounted implement to avoid bouncing and momentary loss of steering control.
11. A heavy load can cause instability of the tractor. Use extreme care during road travel. Slow down on turns and watch out for bumps. Tractor may need front counter-weights to counter-balance the weight of the implement.
12. Reduce speed on hillsides or curves so there is no danger of tipping.
13. Avoid driving too close to the edge of ditches or creeks.
14. Do not transport implement on public toads without reflectors and slow moving vehicle emblem in daylight and with approved warning lights at night and other periods of poor visibility.
15. Due to the width of some implements, use extra caution on highways, farm roads, and when approaching gates.
16. Always be sure the implement is in the proper position for transport.
17. Keep alert and watch the front as well as the rear when working with the implement.

Broadcast Seeder/Spreader OWNER'S MANUAL

MODEL NO.'s

CS-694
CS-1094
CSP-694
CSP-1094

WHEN ORDERING
REPAIR PARTS, ALWAYS
GIVE THE FOLLOWING
INFORMATION:

1. PART NUMBER
2. PART DESCRIPTION
3. MODEL NUMBER
4. NAME OF ITEM

MARCH 2001

Please work, drive, play, and live each day with care and concern for your safety and that of your family and fellow citizens.

MAKE EVERY DAY
A HOLIDAY
FROM ACCIDENTS

3-Pt. Broadcast Seeder/Spreader

WORKSAVER LIMITED WARRANTY

Worksaver warrants its implements, parts and accessories to be free from defects in materials and workmanship for a period of six (6) months from the date of purchase. Upon written approval, **Worksaver** will repair or exchange without charge any part, which upon examination by **Worksaver** or its authorized agent, shall disclose to be defective.

This does not apply to (1) parts that have worn out in normal use, (2) parts broken because of improper assembly or operation by the customer, (3) parts accidentally damaged, (4) failure of parts traceable to improper care, (5) parts failing through use of implement for purposes other than those for which it was designed.

The obligations assumed by **Worksaver** and the limitations expressed herein are in lieu of all other warranties expressed or implied.

WORKSAVER, INC.

P.O. Box 100, Litchfield, IL. 62056-0100

Phone: 1-217-324-5973 Fax: 1-217-324-3356

Web Site: www.worksaver.com E-Mail: sales@worksaver.com