

TANDBERG

2000 *MXP*

User Manual



Software version F3
D13377.03

This document is not to be reproduced in whole or in part without permission in writing from:

TANDBERG

Trademarks and Copyright

All rights reserved. This document contains information that is proprietary to TANDBERG. No part of this publication may be reproduced, stored in a retrieval system, or transmitted, in any form, or by any means, electronically, mechanically, by photocopying, or otherwise, without the prior written permission of TANDBERG. Nationally and internationally recognized trademarks and trade names are the property of their respective holders and are hereby acknowledged.

Contains iType™ from Agfa Monotype Corporation.



Disclaimer

The information in this document is furnished for informational purposes only, is subject to change without prior notice, and should not be construed as a commitment by TANDBERG. The information in this document is believed to be accurate and reliable; however TANDBERG assumes no responsibility or liability for any errors or inaccuracies that may appear in this document, nor for any infringements of patents or other rights of third parties resulting from its use. No license is granted under any patents or patent rights of TANDBERG.

This document was written by the Research and Development Department of TANDBERG, Norway. We are committed to maintain a high level of quality in all our documentation. Towards this effort, we welcome you to [Contact us](#) with comments and suggestions regarding the content and structure of this document.

COPYRIGHT © 2005, TANDBERG

Environmental Issues

Thank you for buying a product, which contributes to a reduction in pollution, and thereby helps save the environment. Our products reduce the need for travel and transport and thereby reduce pollution. Our products have either none or few consumable parts (chemicals, toner, gas, paper) and low energy consuming products.

Battery handling

Batteries for the Remote Control are Long Life and Alkaline batteries saving the environment; please follow guidelines on the packing material for handling and disposal of the batteries.

Waste handling

There is no need to send any products or material back to TANDBERG as there are no consumables to take care of. Please contact your local dealer for information on local waste handling and recycling of electronic products.

Production of products

Our factories employ the most efficient environmental methods for reducing waste and pollution and ensuring the products are recyclable.

Digital User Manuals

TANDBERG is pleased to announce that it has replaced the printed versions of its User Manuals with a digital CD version. Instead of a range of different user manuals, there is now one CD which can be used with all TANDBERG products, in a variety of languages. The environmental benefits of this are significant. The CDs are recyclable and the savings on paper are huge. A simple web-based search feature helps users directly access the information they need. In addition, the TANDBERG video systems now have an intuitive on-screen help function, which provides a range of useful features and tips. If desired, the user manuals on the CD can still be printed locally.

Operator Safety Summary

For your protection, please read these safety instructions completely before operating the equipment and keep this manual for future reference. The information in this summary is intended for operators. Carefully observe all warnings, precautions and instructions both on the apparatus and in the operating instructions.

Equipment Markings

The lightning flash symbol within an equilateral triangle is intended to alert the user to the presence of uninsulated “dangerous voltages” within the product’s enclosure that may be of sufficient magnitude to constitute a risk of electrical shock.

The exclamation mark within an equilateral triangle is intended to alert the user to the presence of important operating and maintenance (servicing) instructions accompanying the equipment.

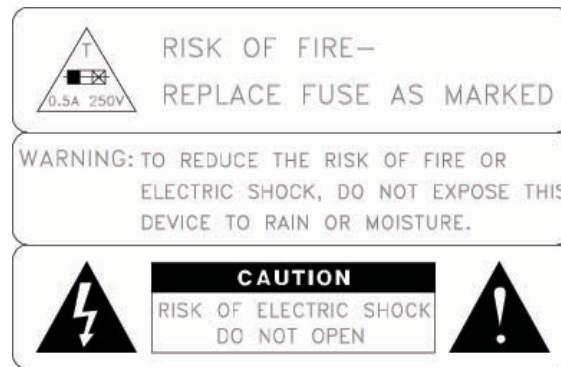

Warnings

- Water and moisture - Do not operate the equipment under or near water - for example near a bathtub, kitchen sink, or laundry tub, in a wet basement, or near a swimming pool or in areas with high humidity.
- Cleaning - Unplug the apparatus from the wall outlet before cleaning or polishing. Do not use liquid cleaners or aerosol cleaners. Use a lint-free cloth lightly moistened with water for cleaning the exterior of the apparatus.
- Ventilation - Do not block any of the ventilation openings of the apparatus. Install in accordance with the installation instructions. Never cover the slots and openings with a cloth or other material. Never install the apparatus near heat sources such as radiators, heat registers, stoves, or other apparatus (including amplifiers) that produce heat.
- Grounding or Polarization - Do not defeat the safety purpose of the polarized or grounding-type plug. A polarized plug has two blades with one wider than the other. A grounding type plug has two blades and a third grounding prong. The wide blade or third prong is provided for your safety. If the provided plug does not fit into your outlet, consult an electrician.
- Power-Cord Protection - Route the power cord so as to avoid it being walked on or pinched by items placed upon or against it, paying particular attention to the plugs, receptacles, and the point where the cord exits from the apparatus.
- Attachments - Only use attachments as recommended by the manufacturer.
- Accessories - Most systems should only be used with a cart, stand, tripod, bracket, or table specified by the manufacturer, or sold with the apparatus. When a cart is used, use caution when moving the cart/apparatus combination to avoid injury from tip-over.
- Lightning - Unplug this apparatus during lightning storms or when unused for long periods of time.

- ISDN cables - CAUTION - To reduce the risk of fire, use only No. 26 AWG or larger telecommunication line cord.
- Servicing - Do not attempt to service the apparatus yourself as opening or removing covers may expose you to dangerous voltages or other hazards, and will void the warranty. Refer all servicing to qualified service personnel.
- Damaged Equipment - Unplug the apparatus from the outlet and refer servicing to qualified personnel under the following conditions:
 - When the power cord or plug is damaged or frayed
 - If liquid has been spilled or objects have fallen into the apparatus
 - If the apparatus has been exposed to rain or moisture
 - If the apparatus has been subjected to excessive shock by being dropped, or the cabinet has been damaged
 - If the apparatus fails to operate in accordance with the operating instructions

Contact us

If you have any questions, comments or suggestions, please see the [Online Support](https://www.tandberg.net) service at www.tandberg.net.

It is also possible to send a fax or mail to the attention of:

Product and Sales Support
TANDBERG
P.O. Box 92
1325 Lysaker
Norway
Tel: +47 67 125 125
Fax: +47 67 125 234

Table of Contents

1	Introduction.....	1
1.1	At a Glance	4
1.2	Menu Structure	6
2	Installation	8
2.1	Mounting	9
2.2	Connecting Cables.....	10
2.3	Monitor Configuration.....	12
2.4	System Configuration.....	13
3	General Use	15
3.1	The Welcome Screen	16
3.2	Using the Remote Control.....	17
3.2.1	Navigation	19
3.2.2	Selfview	20
3.2.3	Layout	21
3.2.4	Mic Off.....	22
3.2.5	Volume + and -	23
3.2.6	Number and Letter keys.....	24
3.2.7	Touch Tones	25
3.3	On-screen Indicators.....	26
3.4	Using the Menu	28
3.5	Make a Call	30
3.5.1	Place Video Call.....	31
3.5.2	Place Telephone Call.....	32
3.5.3	Add Call	33
3.5.4	Call Settings	35
3.5.5	Streaming.....	36
3.6	Answer an incoming call	38
3.7	End Call.....	39
3.8	Standby.....	40
3.8.1	Delay Standby for 1 hour	41
3.8.2	Delay Standby for 3 hours	42
3.8.3	Do Not Disturb	43
3.9	Phone Book.....	44
3.9.1	Call Log	46
3.9.2	My Contacts	47
3.9.3	Global Contacts	54
3.10	Camera Control.....	58
3.10.1	Move Camera	59
3.10.2	Far End Control.....	60
3.10.3	Camera Presets	61
3.10.4	TANDBERG Tracker.....	62
3.10.5	Picture Control	63
3.10.6	Camera Tracking	64
3.11	Presentation	65
3.11.1	Presentation Key.....	66
3.11.2	Presentation Menu.....	67
3.11.3	PC Presenter (DVI/XGA Input)	68
3.11.4	PC Soft Presenter and VNC	69
3.11.5	Dual Stream (DuoVideoTF/H.239).....	70
3.11.6	Take New Snapshot.....	71
3.11.7	Display Snapshot.....	72

3.12	Conference Services.....	73
3.12.1	Request Floor and Release Floor.....	76
3.12.2	Conference Layout.....	77
3.12.3	Terminal Names.....	78
3.12.4	Chair Control.....	79
3.12.5	Assign Floor and Release Floor from Participant.....	80
3.12.6	View Site and End View.....	81
3.12.7	Disconnect Participant.....	82
3.12.8	Terminate Meeting.....	83
3.12.9	More about MultiSite (embedded MCU).....	84
3.13	Control Panel.....	85
3.13.1	Diagnostics.....	86
3.13.2	Text Chat.....	98
3.13.3	Audio Demo.....	99
3.13.4	Administrator Settings.....	100
3.13.5	Restart.....	101
3.13.6	User Guide.....	102
4	Administrator Settings.....	103
4.1	General Settings.....	104
4.1.1	Language.....	105
4.1.2	System Name.....	106
4.1.3	Auto Answer.....	107
4.1.4	Max Call Length.....	108
4.1.5	Phone Book Settings.....	109
4.1.6	Permissions.....	110
4.1.7	Screen Settings.....	112
4.1.8	Software Options.....	117
4.2	Menu Settings.....	118
4.2.1	Menu Timeout In Call.....	119
4.2.2	Welcome Menu.....	120
4.2.3	Welcome Picture.....	121
4.2.4	Logo.....	122
4.2.5	Balloon Help.....	123
4.2.6	Display Welcome Text.....	124
4.2.7	Welcome Text.....	125
4.2.8	Administrator Password.....	126
4.3	Presentation Settings.....	127
4.3.1	Presentation Start.....	128
4.3.2	H.239.....	129
4.3.3	Call Video Source.....	130
4.3.4	Presentation Source.....	131
4.3.5	Snapshot Source.....	132
4.3.6	Auto-Display Snapshot.....	133
4.3.7	PIP Appearance.....	134
4.3.8	PIP Placing.....	135
4.3.9	VNC Settings.....	136
4.4	Call Quality.....	137
4.4.1	Video Algorithm.....	138
4.4.2	Audio Algorithm.....	139
4.4.3	AAC-LD 128kbps (stereo audio).....	140
4.4.4	Natural Video.....	141
4.4.5	Max Upstream Rate (kbps).....	142
4.4.6	Video Quality.....	143
4.4.7	Default Call Settings.....	145
4.5	Audio.....	148
4.5.1	Inputs.....	149

4.5.2	Outputs	151
4.5.3	Echo Control	152
4.5.4	Stereo Settings	153
4.5.5	Audio Levelling (AGC)	154
4.5.6	Alert Tones and Volume	155
4.6	Video	156
4.6.1	Camera Tracking Mode	157
4.6.2	MCU Status Line.....	158
4.6.3	Floor to Full Screen.....	159
4.6.4	Web Snapshots.....	160
4.6.5	MultiSite Picture Mode	161
4.6.6	Video Name	163
4.7	Security	164
4.7.1	Encryption	165
4.7.2	Encryption Mode	166
4.7.3	Passwords	167
4.8	Network	168
4.8.1	ISDN-BRI Settings	169
4.8.2	LAN Settings	171
4.8.3	Network Profiles	188
4.8.4	Data Port.....	189
4.9	Restore Default Settings	190
5	Peripheral Equipment.....	191
5.1	Interfaces	192
5.1.1	Video	192
5.1.2	Audio	194
5.1.3	Network	195
5.1.4	Data port	196
5.2	Document Camera.....	197
5.3	DVD / VCR.....	198
5.4	Additional Cameras.....	199
5.5	Additional Microphones.....	200
5.6	The TANDBERG DNAM	201
5.7	Stereo Speaker Kit.....	203
5.8	Telephone Add-On.....	204
5.9	Dual Monitor.....	205
5.10	XGA Monitors and Projectors	206
5.11	VESA Display Power Management	207
5.12	Digital Monitor Power Management.....	208
5.13	Extended Display Identification Data (EDID)	209
6	Appendices	211
7	Index.....	241
8	Glossary	243

1 Introduction

The TANDBERG 2000 MXP provides a reliable, secure and wireless capable video communication system with superior presentation capabilities for small groups and offices.

Audio Quality

High-performance audio provides a richer, more complete visual communication experience. The MPEG4 AAC-LD standard is used to provide true standards-based CD-quality audio.

Users can record and send stereo audio from presentation and playback sources using PCs, DVDs and VCRs.

NEW Enhanced packet loss handling in the audio decoder

NEW Improved lip synchronization

Video Quality

Features which ensure high quality video includes:

- Natural Video™ which provides 60 fields per second true interlaced picture.
- Support for H.264 in MultiSite, DuoVideo/H.239 and encryption.
- SXGA input and XGA output through DVI-I (analog or digital).
- H.264 video compression up to 2Mbps.
- Support native 16:9 Wide XGA monitors by increasing the resolution to 1280x768 (WXGA).
- Automatic use of WXGA format when "VGA Monitor Format" is set to Wide.

Network

The system supports videoconferencing via both IP and ISDN networks. The bandwidth capabilities are:

- up to 2Mbps* per call
- up to 2.3Mbps* total for a MultiSite conference.
- SIP support, for both point-to-point and MultiSite*.

If channels are dropped during a videoconferencing session, downspeeding™ automatically maintains connections without interruption.

NEW Enhanced packet loss handling and downspeeding™

NEW Remote software upgrade over ISDN

Security

Secure Conference™ provides embedded encryption for both Point-to-Point and MultiSite call and ensures both privacy and security.

The system is delivered with integrated Expressway™ firewall traversal technology. When used together with a TANDBERG Border Controller it enables:

- Secure and seamless traversal of ANY firewall.
- No missing features when traversing the firewall – works with H.264, MPEG4 audio, encryption.

- Outside systems, such as home offices, to be part of the enterprise dial plan.
- Dialing to systems by URI, e.g. user@company.com.

NEW Standards based H.235 authentication towards Border Controller / Gatekeeper

MultiSite*

The embedded MultiSite[™] functionality can cater for up to 4 video sites and 3 audio sites and supports screen layouts such as VoiceSwitched, AutoSplit, 4 Split and 5+1 Split. The MultiSite functionality supports any combination of ISDN and IP participants in a conference.

A superior quality and reliability is ensured by:

- Supporting DuoVideo/H.239, encryption and H.264.
- Rate matching[™] and Transcoding[™] which supports different call rates for all sites in a MultiSite.

The TANDBERG videoconferencing system can also be used purely as an audio-bridge (with an ISDN connection).

Presentations

The Natural Presenter Package* (NPP) makes it possible to run presentations and comprises:

- Digital Clarity[™] which provides presentations of exceptionally high quality resolution video.
- Duo Video[™]/H.239 which allows participants at the far end to simultaneously watch a presenter on one screen and a live presentation on the adjoining screen.
- PC Presenter[™] which is an easily accessible PC connection over a wired VGA cable that supports up to SXGA resolution.
- PC SoftPresenter[™] which shows PC images via the LAN connection supporting XGA resolution.

Users can display video and presentations in the best layout based on the situation. Supported screen layouts are:

- Picture in Picture
- Picture outside Picture
- Side by Side

PC zoom:

- The PC image is transferred in native resolution and may be controlled as a camera with zoom and pan/tilt to get SXGA resolution.

NEW Auto Layout

- The system will automatically choose the best layout for the call

NEW New large Picture outside Picture layout for wide monitors

NEW Local PC Display

- Improved feature when using your local screen s a PC screen.

User interfaces

A web-interface is provided to handle:

- Text chat/closed captioning
- System management, diagnostics and software uploads
- Streaming – which allows broadcasting of audio/video via an IP network

The On-Screen Menu:

- Easy interface for first-time users with symbols and descriptions
- Builds upon the familiar current interface

True Localization with enhanced language support and international customization:

- Enabling Asian and non-Latin character text input on Web and API for local language in Phone Book and System Names

NEW Usability upgrade and improved user feedback

- Improved Phone Book
- On-screen Warnings and Network Statistics information

NEW Including support for Thai and Finnish On-Screen menu language

The remote control has a simplified look and feel, auto system wake-up and large, easy-to-read keys.

Interoperability

The TANDBERG 2000 MXP is worldwide compatible with other standards-based videoconferencing systems.

* - optional feature. To check which options are installed, select Control Panel - System Information in the menu.
TF - TANDBERG First

1.1 At a Glance

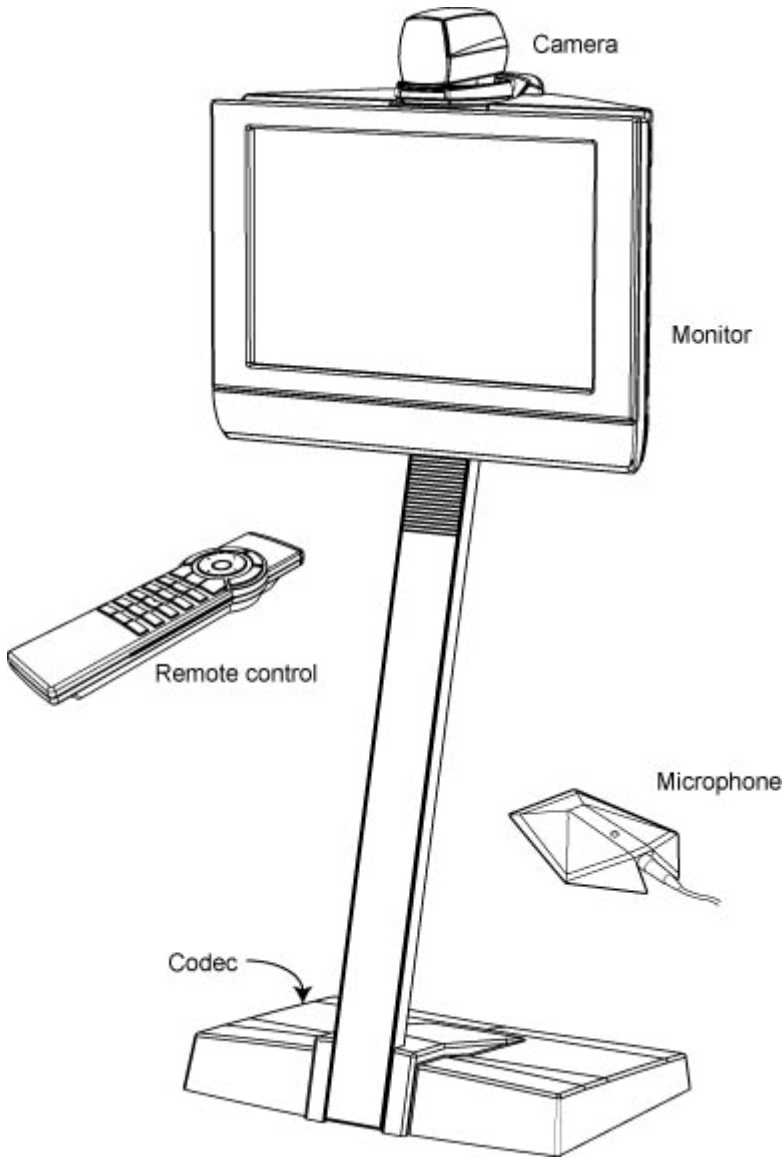

Camera

The main camera is mounted on top of the monitor. The main camera includes a high quality color camera with a fast pan/tilt/zoom action. The main camera is controlled by the system's infra-red remote control and operates pan/tilt, focus and zoom.

Monitor

The monitor displays the far-end and near-end videoconferencing sites in addition to the menus.

Note that the monitor pictures/drawings used in this manual might differ from the actual monitor model shipped with the system.

Codec

The codec is the heart of the system. Its main task is the compression of outgoing video, audio and data, the transmission of this information to the far end and the decompression of the incoming information - the name codec comes from a combination of the two words compression and decompression.

Remote Control

The remote control is used to control all functions of the system. If the screen saver is activated (black monitor), touching the remote control will automatically wake up the system. The remote control uses 4 AAA batteries. The system will tell you when batteries are running low. Change the batteries at the back of the remote control.

The reach of the remote control signal is 20 meters. For users sitting in an open plan office, this can cause problems. Use the little, white switch placed under the batteries to change the reach of the signal from 20 meters to 2 meters. This will prevent you from unintentionally controlling another video system, when you control your own system.

Microphone

The high quality table microphone is designed to be placed on a table during a videoconference. The ideal location for the microphone is on a flat surface at least 2m (6.5 ft) from the front of the system. The microphone cable should always point towards the system. The system will automatically equalize sound levels. Loud and soft voices are picked up and transmitted to the far end at approximately the same level.

1.2 Menu Structure

The menu structure is divided in two. The Main Menu is available for all users and contains all functionality of the system. The Administrator Menu contains all the settings of the system. The Administrator Settings are accessible from the Main Menu by selecting Control Panel and Administrator Settings. Making changes to the Administrator Settings will change the behavior of the system. The menu structure for Main Menu and Administrator Settings is shown below.

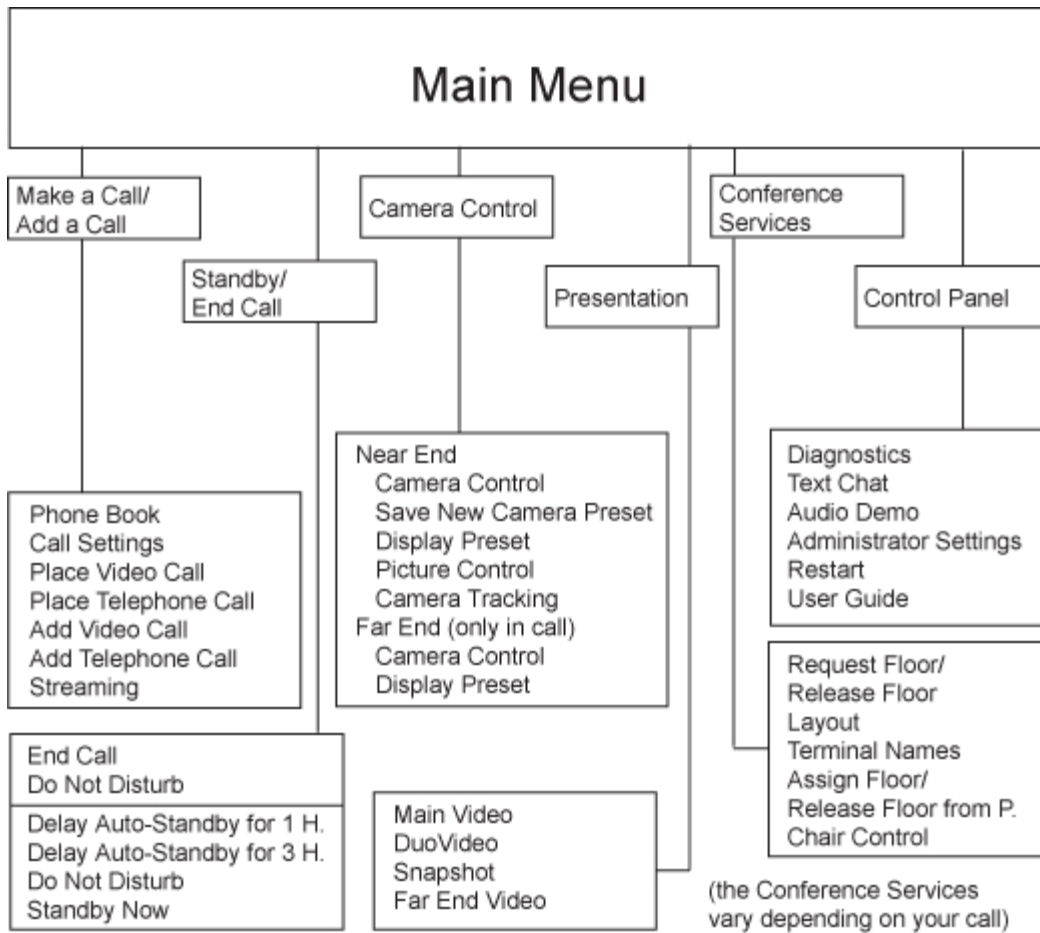

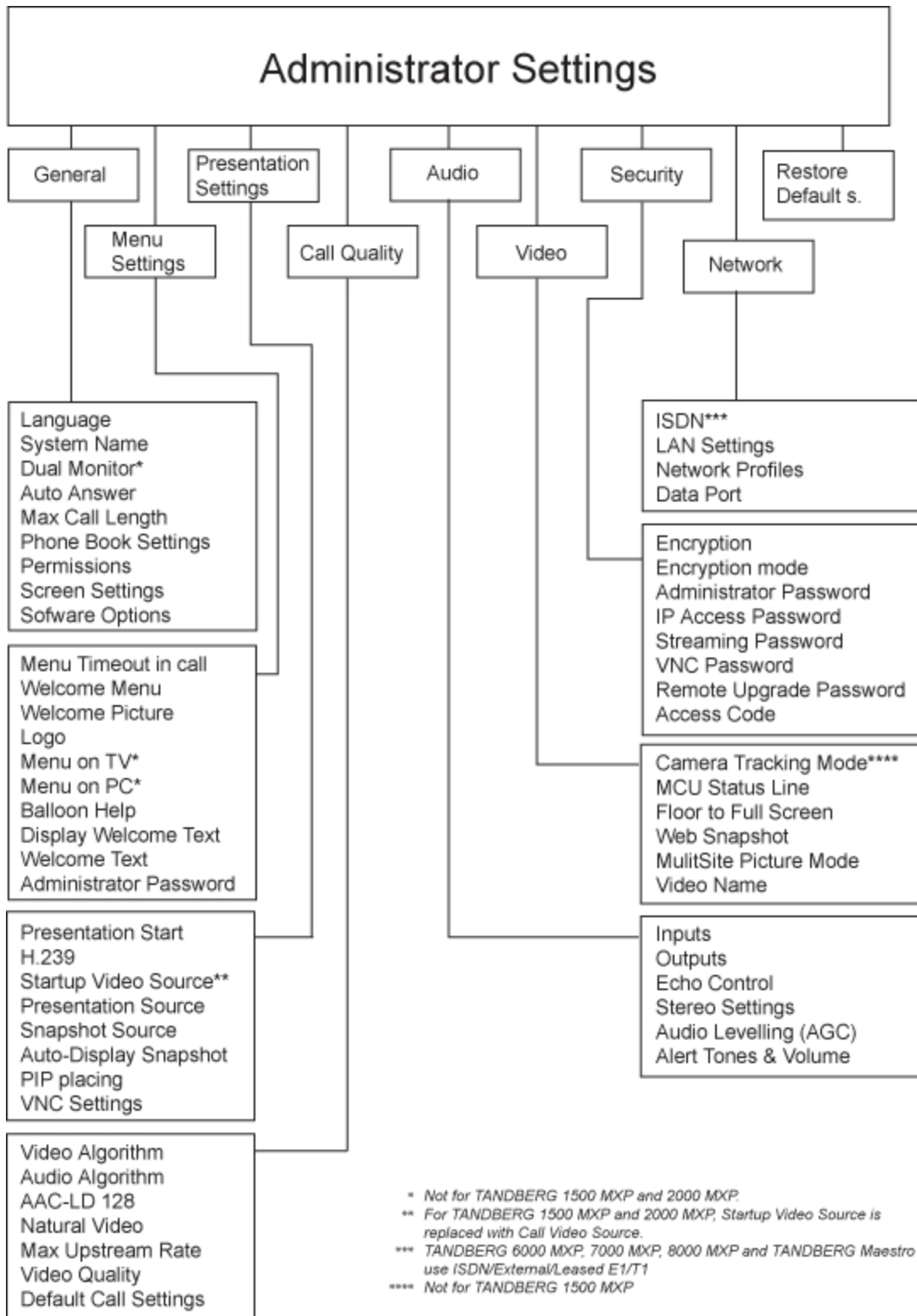

* Not for TANDBERG 1500 MXP and 2000 MXP
 ** For TANDBERG 1500 MXP and 2000 MXP, Startup Video Source is replaced with Call Video Source.
 *** TANDBERG 6000 MXP, 7000 MXP, 8000 MXP and TANDBERG Maestro use ISDN/External/Leased E1/T1
 **** Not for TANDBERG 1500 MXP

2 Installation

Precautions:

- Never install communication wiring during a lightning storm.
- Never install jacks for communication cables in wet locations unless the jack is specifically designed for wet locations.
- Never touch uninstalled communication wires or terminals unless the telephone line has been disconnected at the network interface.
- Use caution when installing or modifying communication lines.
- Avoid using communication equipment (other than a cordless type) during an electrical storm. There may be a remote risk of electrical shock from lightning.
- Do not use the communication equipment to report a gas leak in the vicinity of the leak.
- Always connect the product to an earthed socket outlet.
- The socket outlet shall be installed near to the equipment and shall be easily accessible.
- Never install cables without first switching the power OFF.
- 1TR6 network type is not approved for connection directly to the telecommunications network. This network type is only to be used behind a PABX.

This product complies with directives: LVD 73/23/EC, EMC 89/366/EEC, R&TTE 99/5/EEC

2.1 Mounting

When mounting the TANDBERG 2000 MXP, follow the figures below:

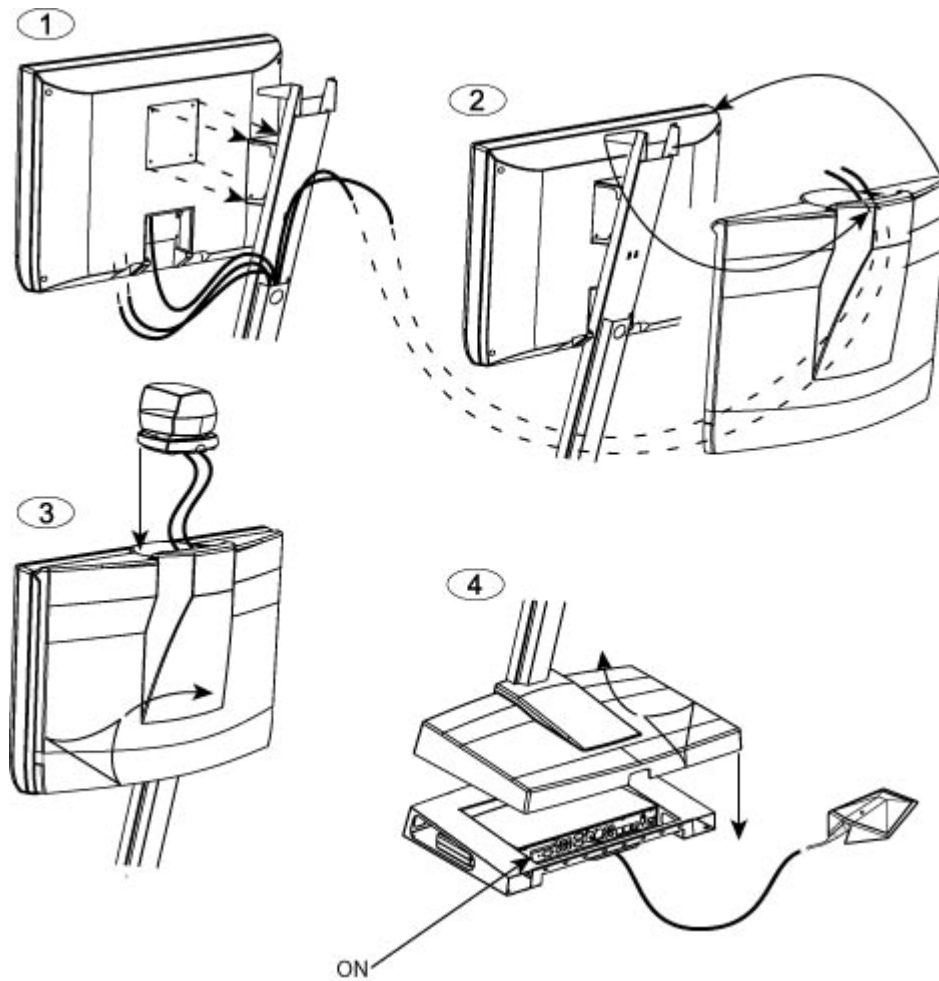

2.2 Connecting Cables

Connect the cables according to the drawing below. This drawing shows only the active connectors. Some products may have additional non-working connectors.

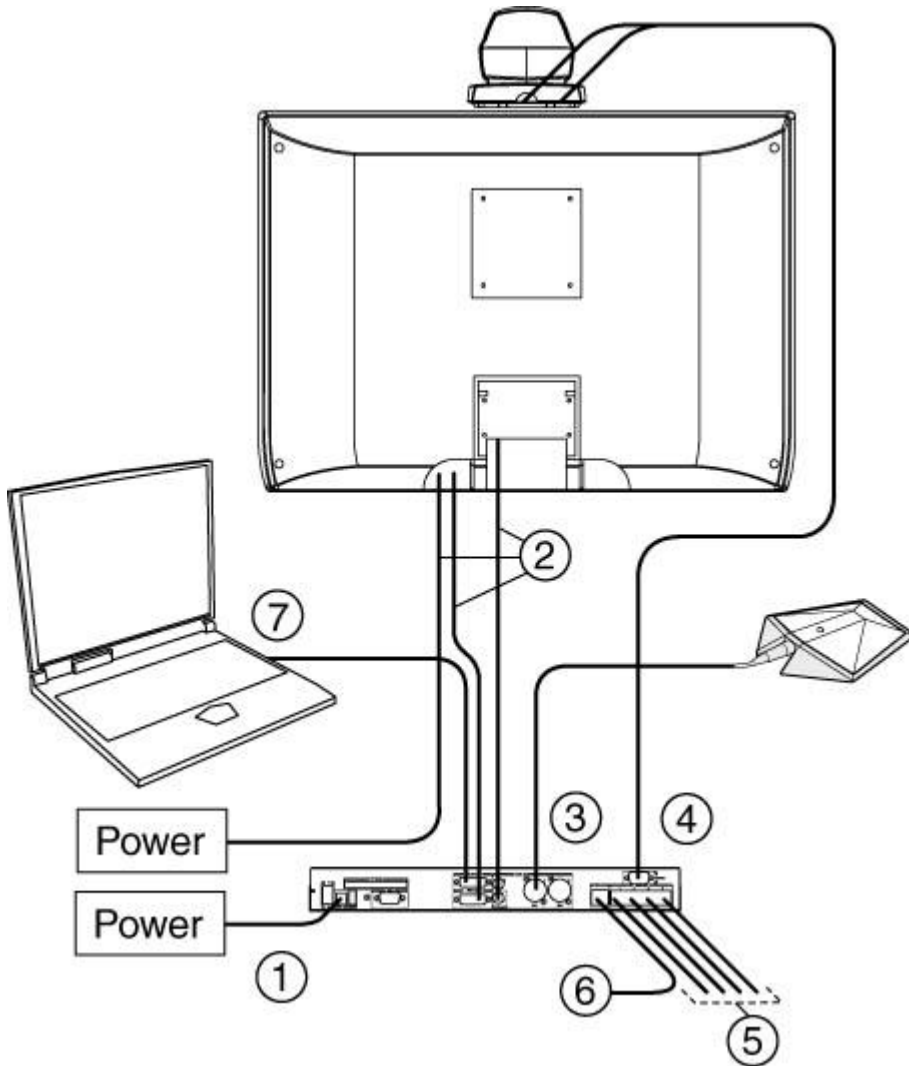

1. Power cable

Connect the system power cable and monitor power cable to an electrical distribution socket.

2. Monitor cables

Connect the Video cable labelled "VGA IN, Main Monitor", the Audio cable (with adapter) labelled "Audio Out" and the power cable to the monitor as shown on the figure.

3. Microphone cable

Connect the microphone cable to the microphone.

4. Camera cable

Connect the camera cable labeled "S-video out" and "Control in" to the camera as shown on the figure.

5 ISDN cables

If using ISDN network, connect the ISDN cables to the ISDN sockets (S/T interface) provided by the network provider. The main ISDN number will be that number associated with the socket to which ISDN cable number 1 has been connected.

Note! The system does not have a built-in network terminator. If the wall socket provides an ISDN U-interface, an NT1 between the system and the ISDN line is needed, see [Appendix 10](#) for more information.

6. LAN cable

To connect the system to a Local Area Network (LAN), connect the cable labeled "LAN Ethernet" to a suitable Ethernet port on the LAN.

7. VGA cable

For using a PC with your videoconferencing system, connect a PC to the codec with a VGA cable. For more information, see [PC Presenter](#).

2.3 Monitor Configuration

Power on the monitor and use the monitor remote control to select the "PC analog" video input and Hypersound OFF.

How to select "PC analog" video input:

1. Press "menu" on the monitor remote control. (Note! Not the TANDBERG remote control.)
2. Select "Input select".
3. Select "PC analog".

How to set Hypersound OFF:

1. Press "menu" on the monitor remote control.
2. Select "Sound".
3. Go down to "Hypersound" and set to "OFF". Use arrow keys left and right to change the setting.

2.4 System Configuration

The system must be configured for each installation. Configuration settings can be made via the system menu.

Navigate through the menu system using the arrow keys and OK. Remember to press the Save button on the bottom of each menu to save the changes. Press Cancel (x) to return to the previous Menu. See [General Use](#) for more information about how to use the menus and the remote control.

General configuration:

1. Open the General Settings menu

Press OK/Menu to open the Main Menu, if not already displayed. Select Control Panel - Administrator Settings - General to open the General Settings menu.



2. Language

Press OK in the Language field and select the wanted language from the list.

3. System Name

Enter a name in the System Name field using the number keys on the remote control, in the same way as with a mobile or cellular phone.

4. Auto Answer, Max Call Length, Phone Book Settings and Permissions

Leave Auto Answer, Max Call Length, Access code and Permissions unchanged if no special needs are required. See chapter [General Settings](#) for more information.

5. Screen Settings

When using wide screen (16:9) monitors, set TV Monitor Format to Wide (16:9). TANDBERG also recommends setting Picture Layout to Picture outside Picture when

using 16:9 monitors. Picture outside Picture provides a display layout optimized for wide screen monitors. The display layout may be changed at any time using the Layout button on the remote control.

6. Software Options

To activate all options for the system, a new option key must be entered in the Software Options menu (see paperwork accompanying the system). The Presenter option key should be entered under "New Option Key". Any bandwidth option key should be entered under "New Bandwidth Key". For more information on these options, please contact your TANDBERG representative.

7. Save changes

Remember to save any changes made in a menu by selecting the Save button on the menu line and pressing OK.

Network configuration:

1. Open the Network menu

Press OK/Menu to open the Main Menu, if not already displayed. Select Control Panel - Administrator Settings - Network to open the Network menu.



2. ISDN configuration

Set the Network type to the desired network. Specify the settings for the selected network in the relevant menu. For details, follow the instructions in [ISDN-BRI Settings](#). See also the examples in [Appendix 9: Connecting the system to the Switched 56 network](#) and in [Appendix 10: Connecting the system to ISDN using NT1 network adapters](#).

3. LAN configuration

Select LAN Settings in the Network menu and specify the necessary LAN settings according to the instructions from your LAN administrator. For details, follow the instructions in [LAN Settings](#). If there is an H.323 Gatekeeper present on your LAN, refer to [H.323 Settings](#) as well.

4. Network Profiles

Please refer to [Network Profiles](#) for details

5. Data Port

Please refer to [Data Port](#) for details

6. Save changes

Remember to save any changes made in the menu by selecting the Save button on the Menu line and pressing OK.

3 General Use

Wake up the system

When the system is not in use, it is in standby mode and the screen is black. Wake up the system by picking up the remote control. An incoming call or pressing any key on the remote control will also wake up the system.

If the system does not respond:

- Make sure that the system is switched on by using the On/Off switch located at the rear of the Codec.
- Verify that your monitor is switched on.

3.1 The Welcome Screen

When the system is switched on, the welcome screen will be displayed. The welcome screen presents the menu and displays your main camera image in the background (main camera is system default). The ISDN/IP numbers and the system name are displayed in the upper right corner. The ISDN Number and IP Number are the dial-in numbers of the system.

The welcome screen provides you with the most important system information:

- System Name
- Your ISDN Number
- Your IP Address or IP Number
- Indications of [Missed Calls](#) or [Warnings](#) if any

It is possible to customize the text on the welcome screen. See [Menu Settings](#) for how to edit welcome text.



3.2 Using the Remote Control

The system is controlled with a remote control. Think of the remote control as a mobile phone with number keys and call keys. Use the arrow keys and OK to navigate the menu. The system's most commonly used functions are also accessible directly from the remote control.

The Infra Red (IR) sensor for the remote control is located in front of the WAVE II Camera.



1. Mic Off turns your microphone on and off, see [Mic off](#).
2. Arrow keys are used for navigation in the menu and for moving the camera* when the menu is hidden, see [Navigation](#).
3. Volume + and – adjusts the Codec volume only and not the monitor's volume, see [Volume + and -](#).
4. The Layout key toggles between full screen and different display layouts, see [Layout](#).
5. Cancel takes you back one step in the menu system. Use Cancel to delete characters in an input field, see [Navigation](#).
6. Press the Call key to place a call, see [Make a Call](#).
7. Camera presets define specific camera positions. Move the camera to the desired position and press and hold a number key for 1 second to save the current camera position to that number key. To activate a preset whilst in a call, simply press and release that number key, see [Camera Presets](#).
8. Snapshot takes a snapshot of your video only while you are in a call, see [Take New Snapshot](#).
9. The Presentation key switches to a predefined presentation source. If the Presentation key is held down for 1 second then the Presentation video sources menu will appear, see [Presentation Key](#).
10. Press OK/Menu to show the menu and to select menu items, see [Navigation](#).
11. Use Zoom + and – to zoom the camera in and out.*
12. Selfview displays your outgoing video. Press Selfview again to turn selfview off,

see [Selfview](#).

13. Use the Phone Book to store and recall video contacts for easy placement of calls, see [Phone Book](#).
14. Use the red End Call key to end the current call. Pressing this key when not in a call will place the system in Standby mode, see [End Call](#) and [Standby](#).
15. Number/Letter keys function in the same manner as with a mobile or cellular phone, see [Number and Letter keys](#).
16. Press Touch tones when you are in a call and need to dial extension numbers etc. (instead of presets). Press the OK/Menu button to exit Touch Tones, see [Touch tones](#).

*This does not apply to all systems with small integrated cameras.

3.2.1 Navigation



Arrow keys and OK

Navigate in the menu with the arrow keys on the remote control. The orange selector on screen shows the selected item. Press OK to select.



Cancel key

In the main menu, pressing Cancel (X) will hide the menu. If the menu is hidden, bring it back with OK. In other menus, pressing Cancel (X) takes you one step back. In an input field, pressing Cancel (X) will delete characters/numbers to the left.



Back/Cancel button

The X button in the menu corresponds with the X key on the remote.

3.2.2 Selfview

The term “Selfview” means the outgoing image. In a normal call, using main camera, this is the image of your self. The Selfview button toggles the images between Far End, Selfview and Dual Video (if any).

How to use Selfview:

1. Outside a call, pressing the Selfview button will switch between the near end video and a black screen on the main monitor.
2. In a point to point call, press the Selfview button once to switch from far end video to near end video see a full screen picture of the outgoing video. Press Selfview again to go back to normal.
3. In a point to point call with a dual video stream, the dual stream is displayed in the big picture. Press the Selfview button to toggle to the Near End picture, then the Far End picture, and finally back to the dual stream.

The above behaviour is similar for both single monitor systems and dual monitor systems. Selfview applies for the main monitor.

3.2.2.1 Local PC Display

When using the screen as your PC screen, it is recommended to set Local PC Display to On, see [Screen Settings](#). That implies that you can display your PC locally while having a videoconference, and you can keep on working without having the Far End participant watching your PC screen.

It is also recommended to keep the Auto Layout setting On (default) to get a suitable layout when toggling from Local PC Display mode to standard conference mode.

Use the Selfview button to toggle between Local PC Display mode and standard videoconference mode. An indicator tells you that your PC image is displayed locally.

Example:

You are using the system as a PC and get an incoming call.

When the setting “Use Screen as Local PC monitor” is On, you will keep your PC image displayed locally and the incoming call pops up as smaller images in a 1+3 layout. You will see Local PC displayed in the big picture and Far End and Near End (your self) displayed in smaller pictures.

Press the Selfview button to switch to standard conference mode. The Local PC image is no longer displayed and Far End is displayed in the big picture. Press Selfview again to see Near End. Pressing Selfview a third time will bring back the Local PC display mode.

3.2.3 Layout

The layout of the screen can either be shown as Picture in Picture (PIP) or Picture outside Picture (POP) when displaying more than one video image. The behaviour of the Layout button is dependent on the Picture Layout setting in [Screen Settings](#).

3.2.3.1 Picture in Picture

When Picture Layout is set to PIP, the Layout button makes it possible to see a second image in a smaller view in one of the corners of the screen. The second image will be placed on top of the main image. The user can decide in which corner the second image is to be displayed.

3.2.3.2 Picture outside Picture

When Picture Layout is set to POP, the Layout button makes it possible to see up to three images in a composition optimized for wide screens. The second image can be displayed either as a side-by-side the main image (1+1) or smaller images next to the main image (1+2 and 1+3).

Press the Layout button once to get side-by-side view (1+1). Press again to get the layouts 1+2 and 1+3, and finally go back to full screen view. You can also go back to full screen directly by pressing and holding Layout for 1 second. It is recommended to use Picture outside Picture for wide screen monitor systems.

3.2.3.3 Auto Layout

The system will automatically choose the best layout for your call. The layouts vary depending on how many participants there are and if you use a dual video source or not. You can however always change layout manually with the Layout button. Auto Layout applies when you open or close a dual stream, or add or disconnect participants.

Auto Layout also includes the former automatic PIP. That implies that PIP will automatically be shown when suitable, e.g. to display selfview when you move your near end camera. The automatic PIP times out after a couple of seconds.

If Auto Layout is Off you will get no automatic layout changes during a call and the user must manually control the images with the Layout button. Auto Layout is default On. To turn Auto Layout Off, go to [Screen Settings](#).

3.2.4 Mic Off

To mute the microphone during a call, press the Mic off button. An on-screen indicator appears in the upper right corner when the microphone is off. In a call, if audio is detected, the on-screen symbol will start to flash. Pressing the Mic off button one more time will activate the microphone again.

Note that Mic off will mute all microphone inputs, but will not mute audio from the AUX and VCR inputs.

When an incoming call is answered, the microphone may be in the off state because the Auto Answer setting is On+Mic off, see [Auto Answer](#). The icon will start to flash when you start speaking. Remember to turn the microphone on before a meeting.

3.2.5 Volume + and -

Press the Volume key to adjust the volume level. An on-screen indicator will show the current level.

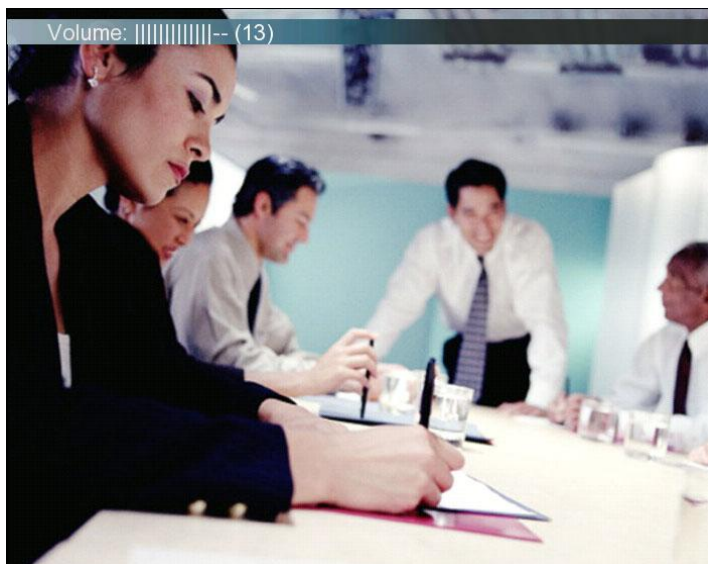

3.2.6 Number and Letter keys

Pressing a number key when outside a call will bring up the call menu. When in a call, the number keys are used for Camera Presets. Press a number and go to the corresponding Camera Preset (see [Camera Presets](#)). However, when having an input field where numbers are required, the system automatically goes to number mode and numbers can be dialed with the number keys as usual.

When in an input field where letters are required, the system automatically goes to letter mode. Writing letters works like on a mobile phone. Press the key that corresponds to your desired letter. Press the key as many times as needed to get the right letter. Change to lower or back to upper case letters with the a/A key, and space with the 0 _ key.

To write numbers in a text input field, press the button through all the letters. Press once more and the number will appear.

Example: How do I write "System 123" in the System Name input field (in General in Administrator Settings)?

Press the 7-key four times to get an "S".

Press the #-key once to switch between upper case and lower case letters.

Press the 9-key three times to get a "y".

Press the 7-key four times to get an "s".

Press the 8-key once to get a "t".

Press the 3-key twice to get an "e".

Press the 6-key once to get an "m".

Press the 0-key once to get space.

Press the 1-key three times to get a "1".

Press the 2-key four times to get a "2".

Press the 3-key four times to get a "3".

3.2.7 Touch Tones

If wanting to dial extension numbers during a call, press the Touch tones button to activate the number keys, otherwise the number keys will activate the corresponding camera presets. An indicator will tell that Touch tones are enabled. Finish with OK to exit Touch tone mode.

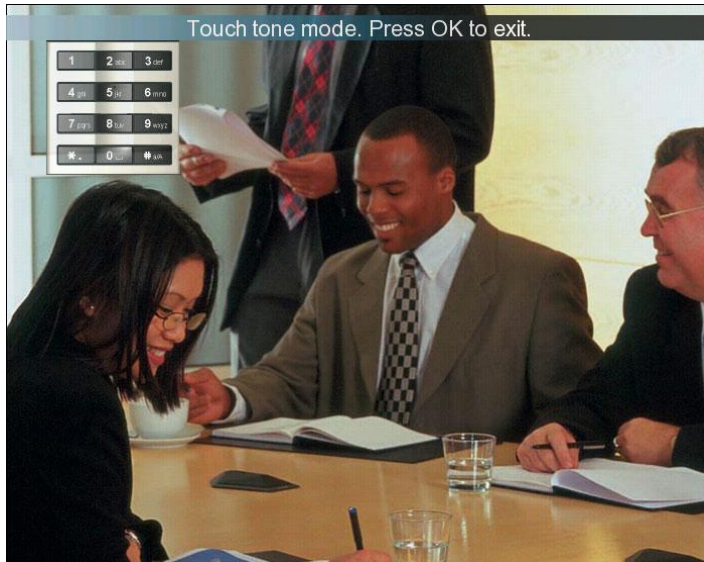

3.3 On-screen Indicators

The system has a number of icons signaling different settings:



Microphone Off

This indicator is shown when the microphone is turned off. Press the Mic off button again to turn the microphone back on, see [Mic Off](#) for details.



Volume Off

This indicator is shown when the volume is turned off. Press Volume + to turn the volume back on, see [Volume + and -](#) for details.



Secure Conference, AES

This double padlock indicator is shown when AES encryption (Secure Conference) is active, see [Security](#) for details.



Secure Conference, DES

This padlock indicator is shown when DES encryption (Secure Conference) is active, see [Security](#) for details.



Not Secure Conference

This open padlock indicator is shown during the initialization phase for AES or DES encryption. During this period the call is not secure, see [Security](#) for details.



Warning

This indicates that the system has detected a warning. Select the icon and press OK to see details on the warning. Please see [Warnings](#) for a list of possible warnings.



Bad Network

This indicator appears if the system detects network anomalies like packet loss, jitter etc., during a call. Open the menu by pressing the OK/Menu button and select the warnings icon too see details.



Floor

This indicator is shown when you are displayed in full screen in a multipoint conference, see [Request Floor and Release Floor](#) for details.



Telephone

This indicates that there is a telephone participant in the conference. The displayed number indicates how many telephone participants there are in the conference.

3.4 Using the Menu

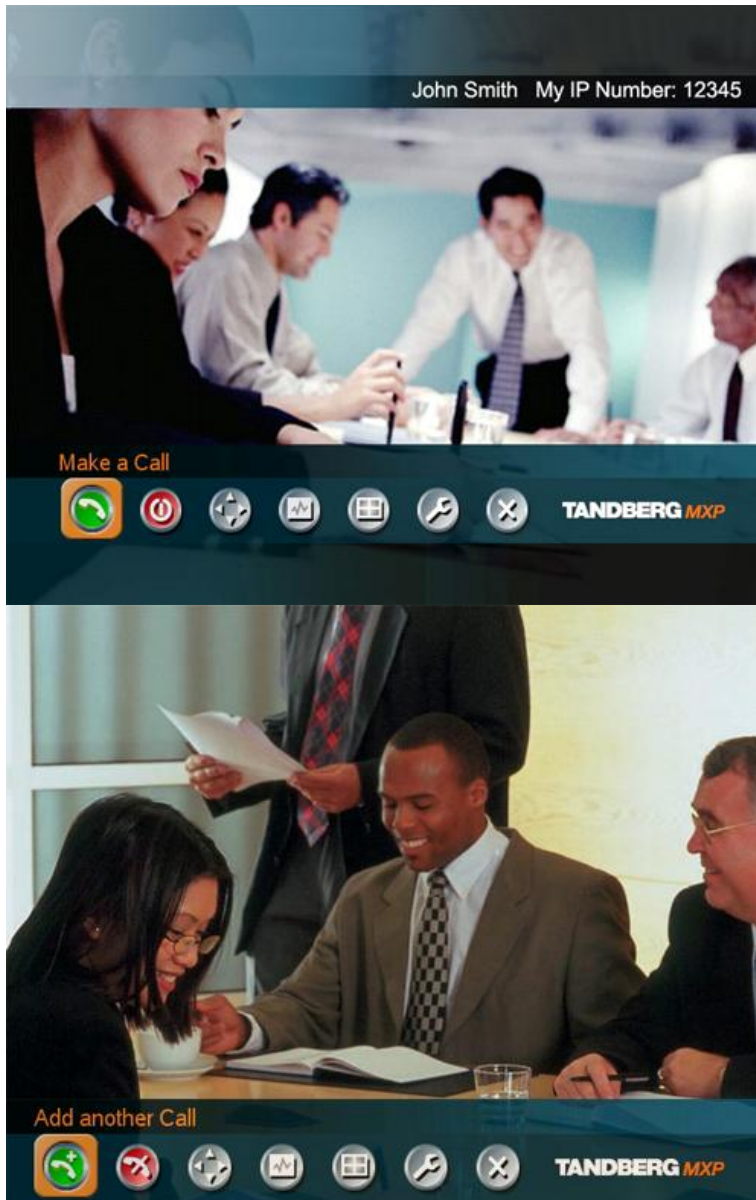

Main menu outside a call and in a call.

Press the Menu button on the remote control to display the menu. The menu contains all functions needed in order to control the system.

The menu contains the following items:

- [Make a Call/Add Another Call](#)

- [Standby/End Call](#)
- [Camera Control](#)
- [Presentation](#)
- [MultiSite Services](#)
- [Control Panel](#)
- Close

See [Menu Structure](#) for a full overview of the menu.

The functions of the menu are displayed as icons. The currently selected icon is marked by an orange square, and the name of the corresponding function is displayed on the line above, see the figure above.

Press the OK button to activate the current selected function.

The menu automatically times out after 15 seconds if not used, see [Menu timeout](#). Press the Menu button to bring it back. It is also possible to hide the menu manually by pressing the Cancel button on the remote control or select the Close icon in the menu.

* Systems with no Camera Control icon available may have a Far End Control icon present when in a call and Far End Control possible.

3.5 Make a Call

Display the call menu by either:

1. Select Make a Call from the menu, or
2. Press the green Call button on the remote control

The TANDBERG system can make both [video calls](#) and [telephone calls](#).

[Call Settings](#) specifies the quality of the call. It is possible to alter the default call settings for the current call if required. The Default Call Settings are defined in Control Panel - Administrator Settings - Call Quality - [Default Call Settings](#).

It is possible to start [streaming](#) from this menu.

For setting up a MultiSite conference, see [Add Call](#) for more details.



3.5.1 Place Video Call

In the Make a Call menu enter the Dial Number either:

1. Manually, or
2. Select the book symbol in order to display the [Phone Book](#) and select a conference participant.

When dialing manually, toggle between ABC/abc by pressing the # button on the remote control and between abc/123 by holding the # button for one second. Use a star as separator in IP addresses. If a system is registered on a gatekeeper or border controller with DNS support, there are several ways to call into the system:

- <IP address>
- <E.164>
- <H.323 ID>
- <H.323 ID>@<domain>
- <E.164>@<domain>

See [H.323 Settings](#) for details.

Place the call by either:

1. Press OK on the remote control so that the Place Video Call icon is selected, and press OK once again, or
2. Use the arrow button on the remote control to select the Place Video Call icon and press OK, or
3. Press the green call button on the remote control.

Note that the call will be set up as a telephone call if the Call Type in Call Settings is set to Telephone Call. See [Default Call Settings](#) for more details.



3.5.2 Place Telephone Call

In the Make a Call menu enter the Dial Number either:

1. Manually, or
2. Select the book symbol in order to display the Phone Book and select a conference participant, see [Phone Book](#) for details.

When entering a Dial Number manually, toggle between abc/123 by pressing the # button on the remote control for one second. Use a star as separator in IP addresses.

Place the call by either:

1. Press OK on the remote control, select the Place Telephone Call icon and press OK once again, or
2. Use the arrow button on the remote control to select the Place Telephone Call icon and press OK.

When dialing a telephone number and pressing the green Call button on the remote control, the system will in most cases automatically interpret the number as a telephone number and not a video number. The interpretation can sometimes take a little while and it is faster to use the Place Telephone Call button in the menu.

See [Default Call Settings](#) for more details.

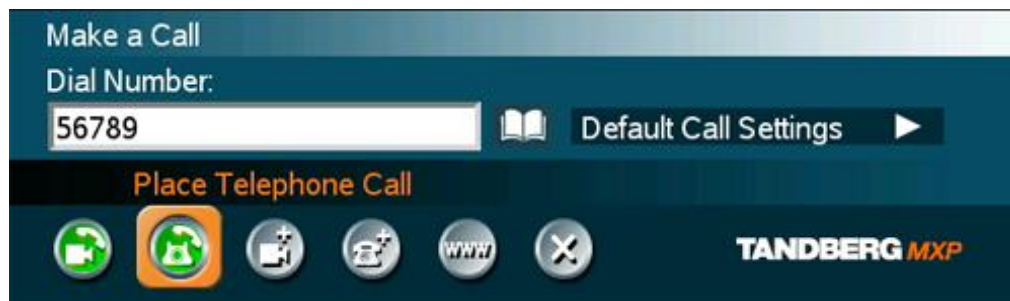

3.5.3 Add Call

(optional feature)

Conference systems with built-in MultiSite can handle up to 4 video calls and 3 telephone calls simultaneously.

It is possible to both set up a conference with many participants and also add participants during a conference.

Set up a conference with two or more participants

In the Make a Call menu enter the Dial Number either:

1. Manually, or
2. Select the book symbol in order to display the Phone Book and select a conference participant, see [Phone Book](#) for details. It is also possible to select a predefined MultiSite entry, see [New MultiSite Contact](#).
3. Press OK on the remote control.

Add another participant to the conference by either:

1. Select the Add Video Call icon if the next participant is using a video system, and press OK, or
2. Select the Add Telephone Call icon if the next participant is using a telephone system, and press OK.

A new entry is now displayed in the call list. Enter the number as described above.

It is also possible to set up a list of all the wanted conference participants by selecting the Add Video Calls and Add Telephone Calls the wanted number of times, and enter their numbers afterwards.

Place a MultiSite call:

1. If the call is a mixed conference with both video and telephone participants, select the Place Video Call icon, or
2. If the call is a conference with telephone participants only, select the Place Telephone Call icon.

Add participant(s) during a conference

Display the call menu during a call by either:

1. Select Make a Call from the menu, or
2. Press the green Call button on the remote control

Enter the new participants in the same way as described above.



3.5.4 Call Settings

The Call Settings specifies the quality of the call. Each call will be set up with the Default Call Settings if the settings are not altered. In this case the field is named Default Call Settings. If the settings for some reason are altered for the current participant in the current call, the name of the field will be changed to reflect this.

Usually it is not necessary for the user to alter the settings.

The Default Call Settings are defined in Control Panel - Administrator Settings - Call Quality - [Default Call Settings](#).

When setting up a call in the Make a Call menu:

1. Select the [Default Call Settings](#) field for the participant and press the OK button on the remote control.
2. Make desired changes to Call Type, Network, Bandwidth and Restrict (56k). If this is to be the new default call settings, select Set as Default in the menu.
3. Select the OK icon and press the OK button on the remote control. The name of the Call Settings field will reflect the changes made.



It is possible to make the changes made to the [Call Settings](#) default by selecting Set as Default and OK. These settings will now be the default settings for all future manually dialed calls.

These settings are also available in the menu Control Panel - Administrator Settings - Call Quality - [Default Call Settings](#).

3.5.5 Streaming

Streaming lets you broadcast your meeting to participants on web. The web participants can listen to the meeting, see snapshots, but not participate themselves. Snapshots of current stream (if MultiSite), selfview, far end and DuoVideo streams are accessible via http. See [Appendix 6](#) for descriptions of the possible snapshot files.

How to use Streaming:

1. Choose Streaming from the Call Menu to open the Streaming menu.
2. Press Start Streaming from the menu line. An indicator will appear on the screen when streaming is activated.
3. Press Stop Streaming to end streaming. Streaming will also end when you disconnect the call.
4. Press Streaming Settings if you want to change streaming settings (see Streaming Settings below)

How to view streaming from a PC:

1. After streaming is started, an easy way to view the streamed audio/video is to start your Web browser and enter the IP-address of the streaming system.
2. After the Web page of the system is shown, click on Streaming. Alternatively, enter `http://<codec ip-address>/stream.sdp`

Streaming Settings

Address	Address is defined as the IP-address of a streaming client, streaming server or a multicast address. Giving an address in the range 224.0.0.1-239.255.255.255 will broadcast the stream to any host that has joined the specified multicast group. Specifying normal broadcast address 255.255.255.255 will broadcast to any members on the LAN.
Address Port	If several codec's are streaming to the same IP-address, different ports have to be used in order for the client to know which stream to receive. If the first codec streams on port 2240 and the second codec on port 2250, the client has to specify which port to listen to. Video is transmitted on the specified port; audio is transmitted on the port number 4 above the specified video port, in this case 2244 and 2254.
TTL/Router Hops	This is used for streaming data to limit how many routers the data should pass before it is rejected. If TTL is set to 2, data will not traverse more than 2 router hops.

Streaming Source*	<ul style="list-style-type: none"> ▪ Auto: Enables streaming of both local and far end video. Selection of which site to be streamed is done using voice switching (the site that speaks is streamed). ▪ Local: Only the local video will be streamed. ▪ Remote: Only the far end video will be streamed. <p>Local and far end audio is always streamed.</p>
Allow Remote Start	<ul style="list-style-type: none"> ▪ On: Streaming can be started from external user interfaces like the Web-browser or Telnet session. ▪ Off: Streaming can only be started from the Video Conferencing System User Interface using the remote control, or by using the Data port. This will prevent activation of streaming using Web browser or Telnet sessions. See also Password section below
Announcements	<ul style="list-style-type: none"> ▪ On: The codec will announce to the network that it is streaming. This enables a streaming client (e.g. a PC) to connect to the codec's streaming session. Used by Cisco IP/TV. ▪ Off: No announcement packets will be transmitted.
Video Rate	<p>Defines the Video streaming rate from the system. Range is 16 kbps - 320 kbps. In addition, audio (G.711) streaming rate is 64 kbps, providing a maximum streaming rate of 384 kbps.</p>
Streaming Password	<p>Set password so that only participants entering correct password will be able to view the streaming session. Entering a password will prevent unauthorized people from accessing the streaming session.</p>

*The streaming source setting is not available when streaming only is supported outside a call.

3.6 Answer an incoming call

How to answer an incoming call:

- To accept an incoming call, press the OK button or the green Call button on the remote control.

How to reject an incoming call:

- To reject an incoming call, select the Reject icon and press the OK button, or press the End Call button on the remote control.



Incoming calls will connect automatically if Auto Answer is set to On, see [Auto Answer](#) for details.

When idle, the system will accept all incoming calls as long as Incoming MCU Calls and Incoming Telephone Calls are set to On, see [Permissions](#) for details. Also, Do Not Disturb must not be activated, see [Do Not Disturb](#) for more details.

3.7 End Call

How to end a call:

- Press the red End Call button on the remote control, or
- Press the Menu button on the remote control to display the menu and select End Call.

When the End Call dialog box is displayed either:

- Press the red End Call button on the remote control again, or
- Press the OK button to confirm that the call is to be ended.

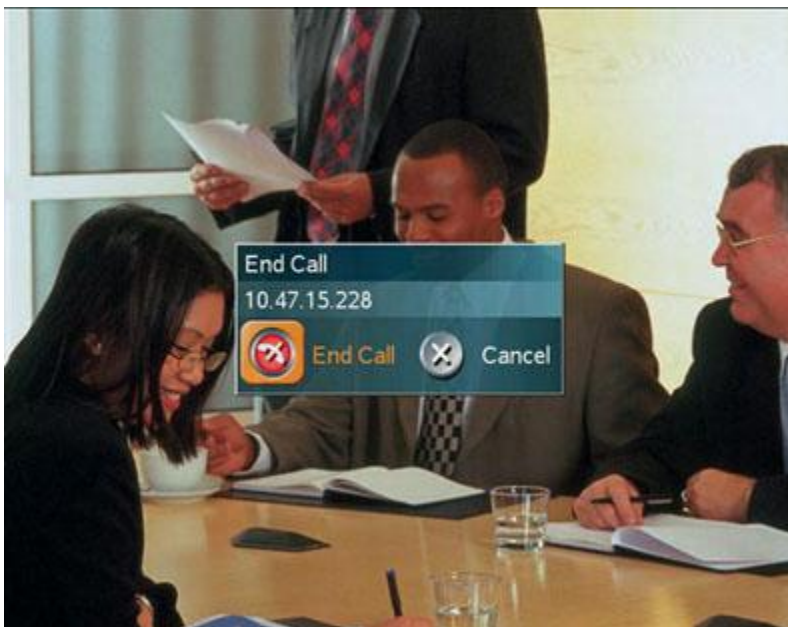

How to end a MultiSite call:

In the list of participants:

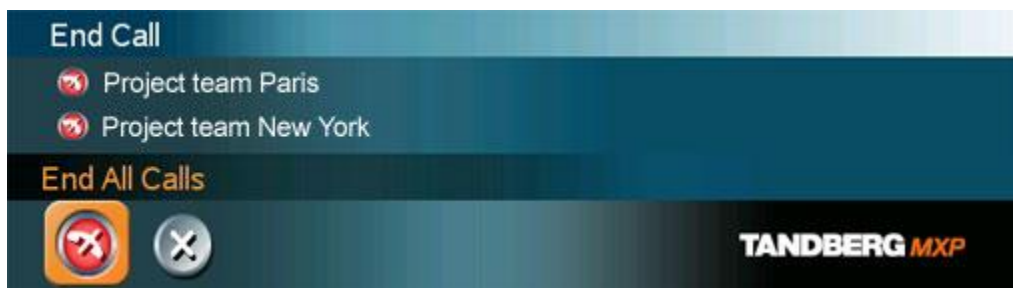

Note that switching off the monitor(s), if they may be switched off individually, will not end a call.

3.8 Standby

The system will automatically go to Standby mode when it is not in use. In standby mode, the screen(s) are black. It is however still possible to receive incoming calls.

How to turn on the standby mode manually:

- Select Standby from the menu and select Standby Now, or
- Press the End Call button on the remote control twice.

How to turn off the standby mode:

- When the system is in standby, pick up the remote control, or press any of its keys to activate the system again.

The standby mode of the system should be used if the system is to be left idle.

Note! Standby is not activated by switching off the monitor(s) (if possible to switch off individually).

It is possible to postpone the system from entering standby mode for 1 hour or 3 hours, see [Delay Standby for 1 hour](#) and [Delay Standby for 3 hours](#).

3.8.1 Delay Standby for 1 hour

Delay Standby for 1 hour postpones the system from entering standby mode for 1 hour.

This function is useful when using the monitors for a local presentation to prevent the system from automatically blanking the monitors.

It is also possible to postpone the system from entering standby mode for 3 hours, see [Delay Standby for 3 hours](#).

3.8.2 Delay Standby for 3 hours

Delay Standby for 3 hours postpones the automatic standby mode for 3 hours.

This function is useful when using the monitors for a local presentation to prevent the system from automatically blanking the monitors.

It is also possible to postpone the system from entering standby mode for 1 hour, see [Delay Standby for 1 hour](#).

3.8.3 Do Not Disturb

To prevent the system from accepting any incoming calls, the function Do Not Disturb has to be activated. The caller will hear a busy tone when calling the system. The monitor will be black when Do Not Disturb is active, see figure below.

End Do Not Disturb by pressing any key on the remote control.

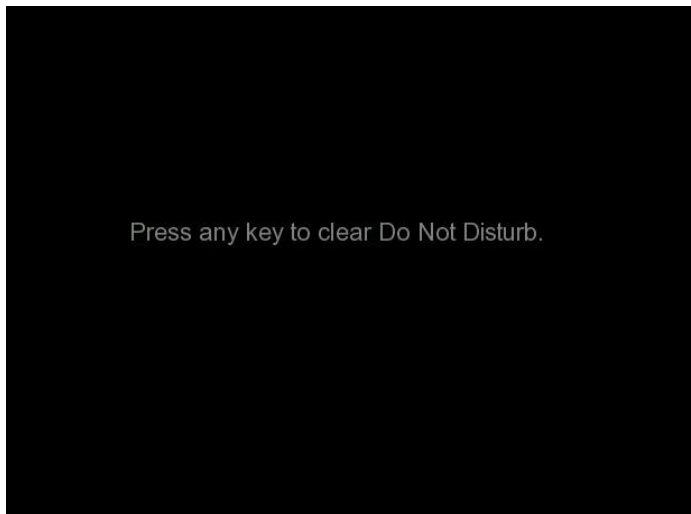

3.9 Phone Book

The Phone Book is available via the Phone Book button on the remote control or from the Make a Call menu.

Using the Phone Book is time saving and prevents the user from inadvertently calling the wrong number. The contacts are sorted alphabetically. The contact names are displayed in the list and the telephone or video numbers, bandwidth and net profiles of the selected contact is displayed at the bottom line.

Navigate up and down in the Phone Book with the arrow keys on the remote control. Use the letter keys to search through the contacts beginning with the typed letter.

The functions in the Phone Book are available when pressing the left arrow key on the remote control, and then the up and down arrow keys. Note that the last selected contact will be marked.

When selecting Phone Book the phone book opens showing the folders Last Number Dialed, Missed Calls, Call History and My Contacts. Global Contacts are listed below these folders.

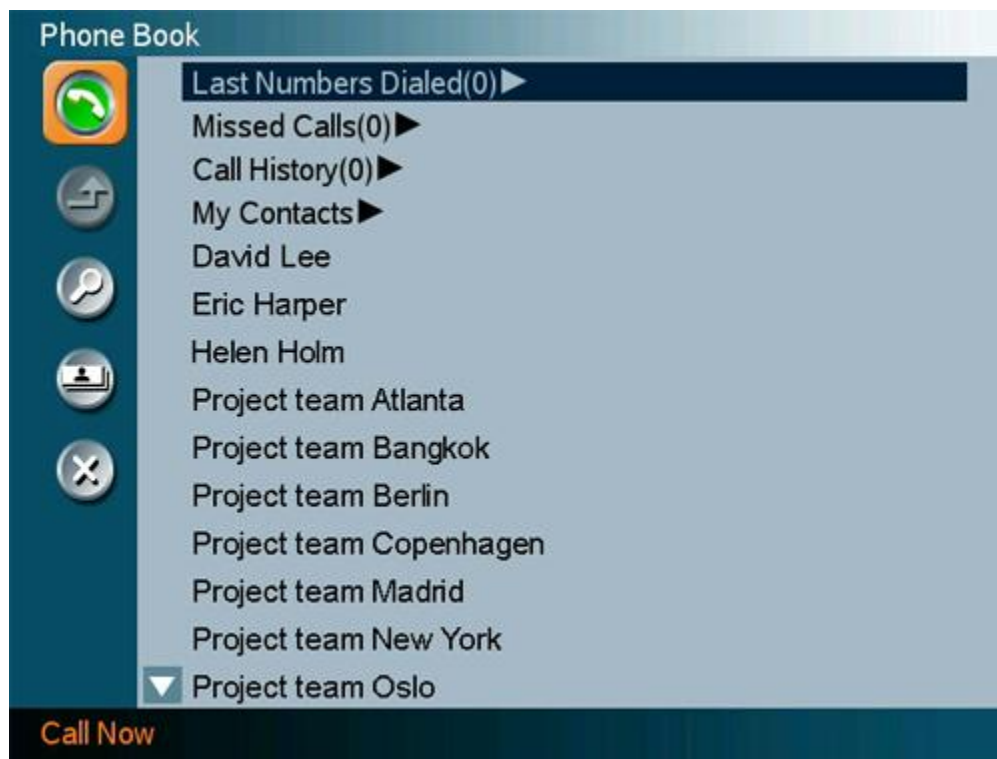

The following information is available from the Phone Book:

- [Last Number Dialed](#)
- [Missed Calls](#)

- [Call History](#)
- [My Contacts](#)
- [Global Contacts](#)

3.9.1 Call Log

The Call Log lists Last Number Dialed, Missed Calls and Call History allows the user to see which calls that are made in the past. The lists contain a maximum of 30 numbers and the numbers are stored in these lists until the system is restarted. If the contacts listed are available in the phone book, the names will be displayed instead of the numbers.

Last Number Dialed lists all outgoing calls. Missed Calls lists the calls that are not accepted. Call History lists all outgoing, incoming and missed calls. The calls in the lists are marked with these icons:

 outgoing calls

 incoming calls

 missed calls

The following buttons are available from these folders :

- Call Now
- [Copy to My Contacts](#)
- Delete
- Delete All
- Cancel

How to make a call using the call lists:

1. Select a number from the list.
2. Press the green Call button on the remote control, or press the left arrow key to select the Call Now icon, followed by OK. The call will be set up as a video call or a telephone call depending on the selected contact. Alternatively, press the OK button when the contact is selected. The Make a Call menu will then be displayed with the name of the contact in the Dial Number field, and the Call Settings field will reflect the call settings for this contact. It is possible to alter the call settings before placing the call. The call will be set up as a video call or a telephone call as described in Make a Call.
3. Wait for the call to connect.

How to delete numbers in the call lists do one of the following:

- Choose the Delete button to delete a selected contact from the call list.
- Choose the Delete All button to delete all contacts listed in the call list.

Note that you will not delete contacts from the Phone Book if you delete them from the call lists.

3.9.2 My Contacts

My Contacts are the locally stored contacts on the system. This means that it is possible to add new contacts and edit or delete existing contacts. My Contacts can store up to 200 contacts.

How to make a call using My Contacts:

1. Find the desired contact using the arrow keys or searching on the first letter with the letter keys.
2. Press the green Call button on the remote control, or press the left arrow key to select the Call Now icon, followed by OK. The call will be set up as a video call or a telephone call depending on the settings made when storing the contact. Alternatively, press the OK button when the contact is selected. The Make a Call menu will then be displayed with the name of the contact in the Dial Number field, and the Call Settings field will reflect the call settings for this contact. It is possible to alter the call settings before placing the call. The call will be set up as a video call or a telephone call as described in [Make a Call](#).
3. Wait for the call to connect.

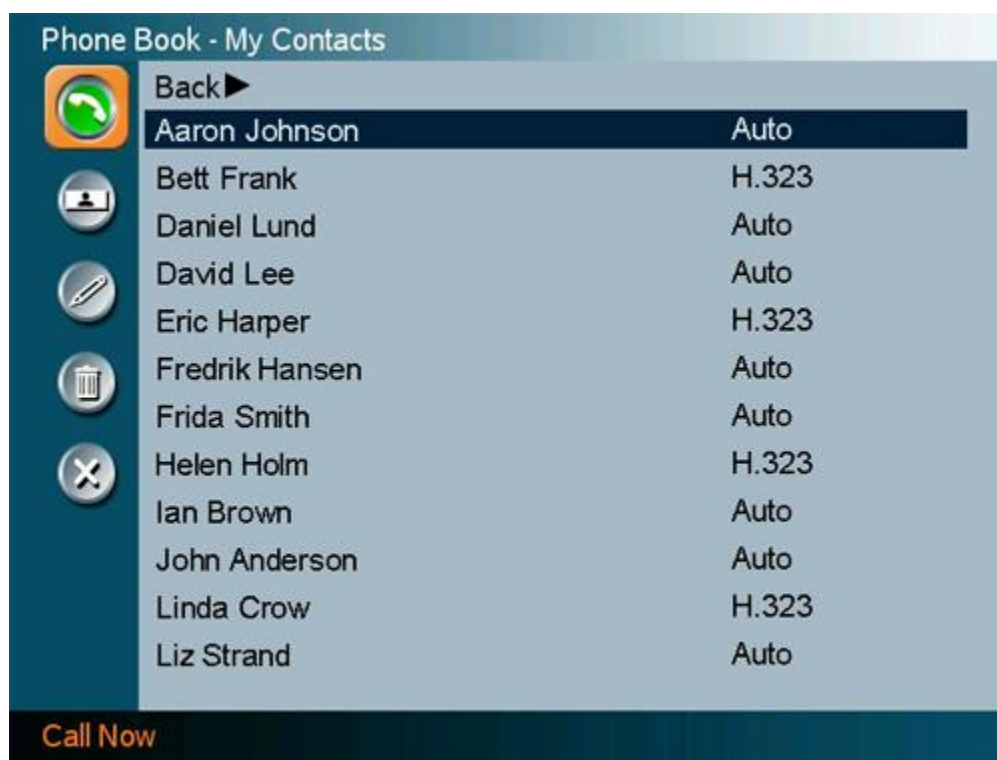

Note that the telephone or video number and profile of the selected contact is displayed at the bottom line.

The following functions are available from My Contacts:

- Call Now
- [New Contact](#)
- [New MultiSite Contact](#)
- [Edit Contact](#)
- [Delete Contact](#)
- Close

3.9.2.1 Add New Contact

The New Contact function is available from [My Contacts](#).

Add a new contact to My Contacts by:

1. Select the New Contacts button to open the New Contacts dialog box.
2. Enter Name by using the letter keys on the remote control. Input will automatically be interpreted as letters. Toggle between capital letters and small letters by pressing the # button on the remote control. The maximum name length is 30 characters. For numbers, press the # button for one second.
3. Enter Number by using the number keys on the remote control. Input will automatically be interpreted as numbers. The maximum number length is 60 numbers. Use a star as separator in IP addresses. For letters, press the # button for one second.
4. Alter the default setting of Call Type if necessary.
5. Alter the default setting of Network if necessary.
6. Alter the default setting of Bandwidth if necessary. For bandwidth 2x64 kbps or 2x56 kbps, two numbers are required, see Default Call Settings for more details.
7. Alter the default setting of Restrict (56k) if necessary.
8. Press OK to save.

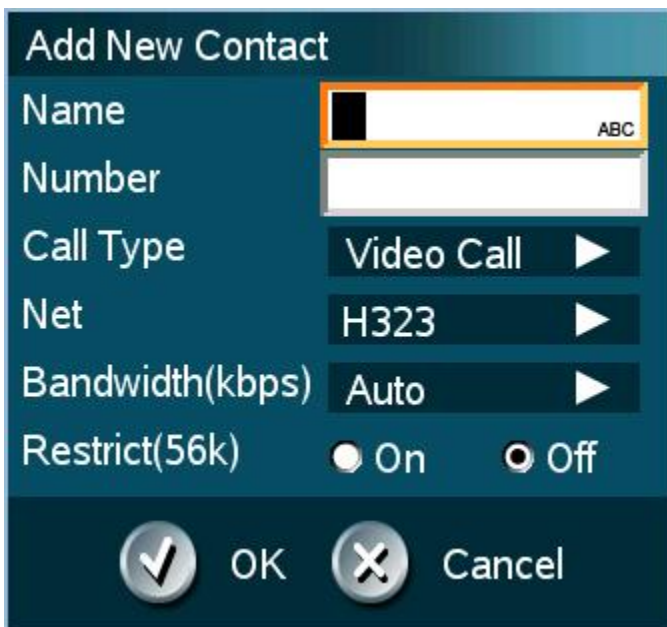

Add New Contact

Name ABC

Number

Call Type Video Call ▶

Net H323 ▶

Bandwidth(kbps) Auto ▶

Restrict(56k) On Off

OK Cancel

3.9.2.2 New MultiSite Contact

(Optional feature*)

The New MultiSite Contact function is available from [My Contacts](#).

It is possible to pre-define the participants of a conference meeting as a MultiSite Contact. All participants in the MultiSite Contact will then be connected automatically instead of having to call the participants one by one.

My Contacts can hold up to 50 MultiSites Contacts. The MultiSite Contacts consist of participants that are already stored in My Contacts.

It is possible to have up to totally 4 video participants and 3 telephone participants in a meeting.

How to define a New MultiSite Contact:

1. Open the Phone Book via the Phone Book button on the remote control or in the Make a Call menu.
2. Select the New MultiSite Contact icon. The New MultiSite Contact dialogue box is displayed.
3. Enter a name of the MultiSite Contact, and press OK on the remote control.
4. Select Add Participant. The contents of the Local Phone Book is displayed. Find the desired contact and press the OK button on the remote control. Repeat until all the desired participants are selected.
5. Press OK to save the MultiSite Contact.

MultiSite

Name

Add Participant ▶

Add Participant ▶

Add Participant ▶

Add Participant ▶

Add Participant ▶

Add Participant ▶

Add Participant ▶

Add Participant ▶

Add Participant ▶

Add Participant ▶

OK Cancel

Bandwidth for a MultiSite Contact call

When calling a MultiSite Contact, the system will try to call the participants with their specified bandwidths. If the total bandwidth exceeds the systems maximum bandwidth, the system will downspeed and distribute the available bandwidth equally for all the participants.

Example: In a MultiSite Contact there is one participant with bandwidth 256kbps and one participant with bandwidth 384kbps. 512kbps is the maximum bandwidth of the system.

The two participants' bandwidth exceeds the maximum bandwidth. The system will then downspeed so that each participant connects with equal bandwidth, i.e. $512\text{kbps}/2 = 256\text{kbps}$.

* The MultiSite option is not available on the TANDBERG 550 MXP, TANDBERG 770 MXP and TANDBERG 1000 MXP

3.9.2.3 Edit Contact

The Edit Contact function is available from [My Contacts](#).

How to edit a contact in the Local Phone Book:

1. Select the contact that is to be edited.
2. Press the left arrow on the remote control, followed by the down arrow until the Edit Contact icon is selected.
3. The current settings for this contact is displayed in a dialogue box. Alter the wanted settings.
4. Press OK to save.

If the altered contact is part of a MultiSite Contact*, the contact will be updated in the MultiSite Contact automatically.



The screenshot shows a dialog box titled "Edit Contact" with a dark blue background. It contains several fields and controls:

- Name:** Helen Holm
- Number:** 45678
- Call Type:** Video Call (with a right-pointing arrow)
- Net:** H323 (with a right-pointing arrow)
- Bandwidth(kbps):** Auto (with a right-pointing arrow)
- Restrict(56k):** On (selected with a radio button) and Off (unselected with a radio button)
- Buttons:** An orange "OK" button with a checkmark icon and a grey "Cancel" button with an 'X' icon.

* The MultiSite option is not available on all systems.

3.9.2.4 Delete Contact

The Delete Contact function is available from [My Contacts](#).

How to delete a contact:

1. Select the contact that is to be deleted.
2. Press the left arrow on the remote control, followed by the down arrow until the Delete Contact icon is selected. The Delete Contact dialogue box is displayed.
3. Confirm by pressing the OK button again.

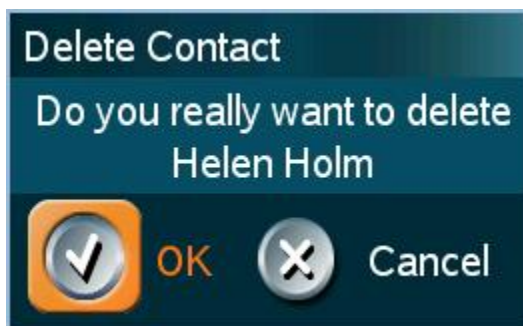

3.9.3 Global Contacts

When selecting Phone Book the phone book opens showing the Global Contacts below the folders Last Number Dialed, Missed Calls, Call History and My Contacts.

Global Contacts are available if the system is connected to an external management system like the TANDBERG Management Suite (TMS). These contacts cannot be changed locally by the system, only from the management system. If there is a need to modify the number or any settings of a contact before making a call, select the contact and press OK on the remote control. The Make a Call menu is displayed and the settings can be altered before placing the call. The changes are not saved.

How to make a call using Global Contacts:

1. Find the desired contact using the arrow keys or searching on the first letter with the letter keys or use the search function described in [Search](#).
2. Press the green Call button on the remote control, or press the left arrow key to select the Call Now icon, followed by OK. The call will be set up as a video call or a telephone call depending on the settings made when storing the contact. Alternatively, press the OK button when the contact is selected. The Make a Call menu will then be displayed with the name of the contact in the Dial Number field, and the Call Settings field will reflect the call settings for this contact. It is possible to alter the call settings before placing the call. The call will be set up as a video call or a telephone call as described in Make a Call.
3. Wait for the call to connect.

From Global Contacts the following functions are available:

- Call Now
- [Up one Level](#)
- [Search](#)
- [Copy to My Contacts](#)
- Close

3.9.3.1 Up one Level

Global Contacts can be arranged in a tree structure with several sub folders. Use the Up one Level button to navigate up in the tree structure.

When a search in the Global Phone Book is made, by using the Search function, only contacts matching the search text are displayed. Select the Up one Level button to return back to the alphabetical list.

3.9.3.2 Search

The phone book can contain an unlimited amount of global contacts. Using search makes it easier to find the wanted contact.

How to search in the Global Phone Book:

1. Select the Search icon.
2. Enter search text in the dialogue box that appears and press the OK button on the remote control. The system will list all entries that contain the entered letter combination.
3. It is also possible to search on first letter in the Phone Book with the letter keys on the remote control.

3.9.3.3 Copy Contact to My Contacts

The Copy Contact to My Contacts function is available from the Last Number Dialed, Missed Calls, Call History and Global Contacts folders, see [Phone Book](#) for details.

It may be wise to copy contacts that are often used to My Contacts. Note that the local copy will not be updated if the Global Contacts are updated from the management system.

How to copy a contact from the Global Phone Book to the Local Phone Book:

1. Select the contact to be copied to My Contacts.
2. Press the left arrow on the remote control, followed by the down arrow until the Copy Contact to My Contacts icon is selected.

A message box telling that the operation was successful will be displayed.

3.10 Camera Control

There are several ways to control the camera:

- Control the camera directly with the arrow keys when the menu is closed or use the Move Camera function in the menu to control both the near end and far end camera, see [Move Camera](#) and [Far End Control](#) for details.
- Use the zoom button on the remote control will zoom the picture in (+) and out (-).
- Use Camera Presets, see [Camera Presets](#) for details.
- Adjust focus, brightness and whitebalance, see [Picture Control](#) for details.
- Use Automatic Camera Tracking, see [Camera Tracking](#) for details.
- Use the TANDBERG Tracker, see separate instructions included with the TANDBERG Tracker.

3.10.1 Move Camera

It is possible to move the camera with the remote control or via the menu.

Moving the camera directly with the remote control

When the menu is hidden, the arrow keys will work on the camera. If the menu is displayed, press the Cancel button on the remote control to hide it. Use the left and right arrow keys to pan the camera, and the up and down arrow keys to tilt the camera. Use zoom + and – to zoom in and out.

Moving the Camera via the menu:

1. Select the Camera Control icon from the menu.
2. Select the Move Camera button in the Camera Control menu.
3. Use the arrow keys on the remote control to pan and tilt the camera.
4. Press OK when done.

3.10.2 Far End Control

Far End Control allows you to control your conference partner's camera. Far End Camera Control is useful if e.g. it is not possible to see what a participant at the far end is writing on their white board. Use Far End Control to move the far end camera and zoom closer on the white board. Use the left and right arrow keys to pan the camera, and the up and down arrow keys to tilt the camera. Use zoom + and – to zoom in and out.

You can also control your conference partner's video sources and presets and request a snapshot from the far end side. Enabling Far End Control will put the system in Far End mode and camera control, camera preset, presentation, and snapshot will work on the far end camera.

Far End Control only works when you are in call and if the far end side supports H.281 (Far End Camera Control). You can prevent others from controlling your system by setting Allow Far End Camera Control to Off in Control Panel - Administrator Setting - General - Permissions, see [Permissions](#) for details.

How to use Far End control:

1. Select the Camera Control icon in the menu.
2. Select the Far End Control icon. When far end camera control is selected an indicator will appear and it is possible to control the far end camera, camera preset, presentation and snapshot for the far end.
3. Deselect the Far End Control button to deactivate far end control mode. This may also be done by pressing the Cancel or the OK button.

Far End Camera Presets

Far End Camera Presets works just like your own camera presets. When Far End is on, use the number keys to activate far end camera presets. You are however not allowed to save far end camera presets.

Far End Presentation

Pressing the Presentation key or choosing a presentation from the presentation menu while Far End is on, will result in opening a far end presentation. Be aware of that the far end video sources may not correspond with the buttons in the presentation menu. If you press Document Camera, the far end side might have another video source on this input.

Request snapshot from the Far End

You can request a snapshot from the far end side. Put the system in Far End mode and press Snapshot on the remote control to take a snapshot of the current far end video (current is default snapshot source).

3.10.3 Camera Presets

Use camera presets to easily vary between predefined near end camera angles. This is useful when pictures from many different camera angles have to be sent to the far end. E.g. in a meeting there is a white board, a PC and a small meeting table. Use camera presets to move between these camera angles in order to present the correct information to the participants at the far end without having to move the camera manually every time. A preset is deactivated when the camera is moved manually with the arrow keys.

Presets are available from the menu. When you are in a call you can also activate presets directly from the remote control. You can save up to 15 presets. Each camera preset is able to store camera angle, video source and audio source selection.

How to use preset directly from the remote control:

When you are in a call you can activate presets with just one press on the number keys on remote control. The number keys will however not work as presets when you are in an input field, in order to write numbers or letters.

1. Press a number on the remote control. The camera will move to the corresponding angle, or video source, stored on that number.

How to use presets via the menu:



1. Select Camera Control - Display Presets in the menu.
2. Select the wanted preset with the arrow keys on the remote control and press OK.

How to save a new preset directly from the remote control:

1. Move the camera to the desired position or select the desired video source that you would like to store as a preset.
2. Press a number on the remote control for 1 second to save the preset. It is possible to store one camera preset on each of the number keys, 0-9, when storing camera presets from the remote control. (Camera preset 10 is stored on the 0-key).
3. The new camera preset will overwrite any existing camera preset on that number.

How to save a new Preset via the menu:



1. Move the camera to the desired position or select the desired video source that you would like to store as a preset.
2. Select Camera Control - Save New Camera Preset in the menu.
3. Enter a number between 1 and 15 and press OK.
4. Type a name for the preset to make it easier to separate the different presets.
5. Press Save. The new Camera Preset will overwrite any existing camera preset on that number.

3.10.4 TANDBERG Tracker

How to save presets for the TANDBERG Tracker:

1. Select which camera preset to be used on the TANDBERG Tracker.
2. Move the camera to the desired position to store on the tracker.
3. Select Move Camera - Save New Preset in the menu.
4. All camera presets are accessible from the TANDBERG Tracker.

For more information, see separate instructions included with the TANDBERG Tracker.

3.10.5 Picture Control

Focus, Brightness and White balance are set for auto focus, auto brightness and auto white balance by default. If you need to set focus, brightness and white balance manually, go to Picture Control in the Camera Control menu.

Focus

Auto	Auto focus continuously updates the focus throughout the call. When moving the camera, the system will use auto focus for 5 seconds to set the right focus of the new camera position. After 5 seconds auto focus is turned off to prevent continuous focus adjustments of the camera.
Temporary	When Temporary is selected, the slide bar is enabled. Use the arrow keys to adjust the focus. The temporary focus will last until you move the camera again and auto focus will take effect.

Camera Brightness

Auto	Auto brightness continuously updates the brightness of the camera picture.
Manual	When Manual is selected, the slide bar is enabled. Use the arrow keys to manually adjust the camera brightness. If brightness is set manually, the system will keep this brightness level also when the camera is moved.

White balance

Auto	Auto white balance continuously updates the white balance.
Manual	When Manual is selected, the “Set White balance” field is enabled. To update the white balance manually, select Manual. A white object should be held in front of the camera a few seconds before and after pressing “Set White balance”. If white balance is set manually, the system will keep this white balance also when the camera is moved.

3.10.6 Camera Tracking

Through Camera Tracking and the use of two or three microphones, the camera can automatically position itself on the current speaker. Before using camera tracking, the camera positions used must be stored at Preset 7 (Mic1) and Preset 8 (Mic2).

How to use Camera Tracking:

1. Select the Camera Control icon in the main menu.
2. Enable Camera Tracking by choosing Camera Tracking. An indicator will appear on the screen.
3. End Camera Tracking by deselecting the Camera Tracking button. Camera Tracking will also end if you activate a camera preset or move the camera manually with the arrow keys.

Example: You have placed Microphone 1 on the table. Where should you position the camera for Preset 7?

The camera position stored at Preset 7 must be related to Microphone 1. Therefore all participants who are located closest to Mic1 should be included in the Preset 7 camera position etc. When camera tracking is activated and a person close to Mic1 speaks, Preset 7 will be automatically selected.

When activating another video source (for instance document camera), camera tracking will be temporarily disabled until you re-select Main Camera or a Main Camera preset.

The camera tracking speeds may be altered in the Video Settings menu in Administrator Settings, see [Camera Tracking Mode](#) for further details.

A Voice Detector makes the system more tolerant of noise and ensures the camera not to be moved by noise such as paper shuffling, etc.

Note that pressing Mic Off will temporarily disable camera tracking until you turn on the microphone again.

3.11 Presentation

The Presentation Functionality in the system enables you to show other available video sources in addition to your Main Camera. This is perfect for meetings where you would like to show a PowerPoint presentation for instance. You can even use arrow keys up and down on the remote control to activate Page Up/Down on the PC (this only applies when using VNC).

Use Presentation outside a call to make a local presentation for the people in your own meeting room. Use Presentation when you are in a call to make a presentation for the far end as well.

The quickest way to show a presentation is to use the [Presentation Key](#) on the remote control. The presentation key shows a predefined video source, PC is default. It is possible to change the presentation source in the Presentation menu. Choose Presentation from the main menu if you want to select a video source manually. The [Presentation Menu](#) offers you all the available video sources supported by your system.



3.11.1 Presentation Key

The quickest way to show a presentation is to use the presentation key on the remote control. The presentation key is used to start and stop a presentation. The presentation key will display PC (default*) or the last used presentation source.

When holding the presentation key for 1 second, the presentation menu will be displayed. This menu allows you to choose other video sources. When choosing a source different from the default presentation source, this source will be temporarily stored as presentation source until next time the system goes to standby.

The default presentation source can be permanently changed in [Presentation Settings](#).

When using the presentation key, your presentation will be displayed as a [Dual Stream](#), if possible. If the call does not support a dual video stream, the presentation will display as main video stream.

How to start and end a Presentation using the Presentation key:

1. Press the Presentation key. The video source that is set as presentation source is displayed in full screen (PC is default). Remember to connect your [PC](#) to the codec in advance.
2. Press the Presentation key again to end the presentation and go back to main camera.

* If available on your system.

3.11.2 Presentation Menu

The Presentation menu offers you all available video sources; Main Camera, PC, Document Camera, VCR, AUX and VNC. All these sources can be used as Main Video Stream or Dual Video Stream (Duo Video / H.239). Not all systems has all video sources available, see [Interfaces](#) for details.

Outside a call the presentation menu only contains Main Video Sources. In a call, the headers Dual Video and Snapshot display in addition to Main Video (if the call supports Duo Video /H.239). Use the up/down keys to change between video sources and headers. Start a Dual Stream by selecting a Dual Video source. Close the Dual Stream by deselecting the video source button.

Note that [Dual Video Stream](#) may not be available if option not installed, not supported on your system or if already activated. Use the up/down keys to change between video source and header.

For Snapshots, see [Take New Snapshot](#) and [Display Snapshot](#).

How to change your main video source:

1. Choose the Main Video header from the Presentation menu.
2. Choose your desired video source and press OK.



How to show a presentation in addition to your main video (Dual Video Stream):

1. Select the Dual Video header.
2. Choose a dual video source and press OK.
3. Deselect the active video source button to end the presentation.



3.11.3 PC Presenter (DVI/XGA Input)

(Optional feature - not available on all systems)

Users often have their presentations on a laptop that is brought into the meeting room. Remember to connect your PC to the codec before you press the Presentation button. Note that the image will appear smoother on the system if your presentation is already displaying in full screen on your PC prior to connecting your PC to the video system.

Plugging a PC into the system is made extremely simple through the PC Presenter, avoiding the need for any additional hardware such as a projector, PC/Video converter or extra cables.

How to connect a PC to the codec with the DVI/VGA cable:

1. Connect the VGA-DVI cable to the PC Presenter (PC DVI-I in) connector on the codec.
2. Connect the VGA-DVI cable to your PC (VGA Output).
3. When the PC is connected to the codec, hit the Presentation key to display the PC image on the system.



If no PC image is displayed on your monitor, make sure that your PC is set to activate your VGA output. On most laptop PCs you must press a special key combination to switch the PC image from the PC screen to the video screen.

Note that the DVI/VGA input is compliant with VESA Extended Display Identification Data ([EDID](#)) and will be able to reconfigure the PC's screen settings if it is currently configured to a VGA format that the system doesn't support.

Also note that you can use the DVI input to transmit high resolution images from document cameras or other sources supporting the HD format 720p.

For details on formats supported on 'DVI-I in', please refer to [Interfaces](#).

3.11.4 PC Soft Presenter and VNC

(Optional feature)

PC SoftPresenter is used to display PC images on your system without using a VGA cable (PC Presenter). The system and your PC must be connected to the same LAN. In addition, VNC (Virtual Network Computing) server software must be installed on the PC. Free software can be downloaded from <http://www.realvnc.com>. Install the software by running the downloaded file.

How to configure the VNC Server software:

1. Select the following to setup VNC; Windows-Start\All Programs\Highlight RealVNC\Hightlight VNC Server>Show User Properties
2. Select Accept Socket Connections.
3. Select Auto for Display Number. Display Number in the system must then have the value 0.
4. Enter a password in the Password-field. This must correspond with the VNC Settings on your system.

How to show PC using the PC Soft Presenter and VNC:

1. Start the VNC software on your PC.
2. To use VNC, you must configure [VNC Settings](#). Open VNC Settings in the Presentation Settings menu in Administrator Settings.
3. Fill in the IP address of your PC, Display Number and Password.
4. Press Save.
5. When you now choose VNC as video source in the Presentation menu, you will see your PC using VNC. If a PowerPoint presentation is being displayed then you can scroll through the presentation by pressing the up and down arrows on the remote control. VNC settings will go back to default when the system goes to standby.

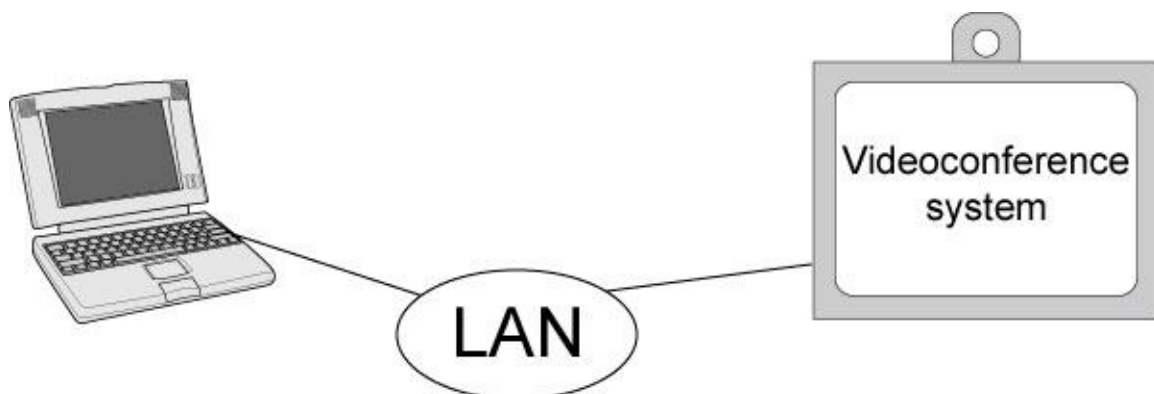

3.11.5 Dual Stream (DuoVideoTF/H.239)

(Optional feature - not available on all systems)

With Dual Stream you have the opportunity to show two different live video streams simultaneously, main video and one additional source. This is handy when showing a presentation. You see the live presentation and the live video of the presenter simultaneously. When you start a presentation, Dual Stream starts automatically if both local and remote system supports Dual Stream. If one of the systems does not support Dual Stream, no second video stream will be established and your presentation will be shown as your main video.

Dual Stream is available on all systems with Natural Presenter Package installed. H.239 is the new ITU standard defining how to send two video sources simultaneously.

Example:

Start a meeting with main camera as video source. Press the presentation key on the remote control to start a PC presentation.

PC will appear as a Dual Video Stream in addition to main camera. End the Dual Stream presentation by pressing presentation key again.

In [Presentation Settings](#), you can set Presentation Start to Manual. That means that Dual Stream will not start automatically.

Example:

Start a meeting with main camera as video source. Press the presentation key on the remote control to start a PC presentation.

A dialog box appears where you can choose to show PC as Dual Video Stream or not. This is handy if you not always want to use Dual Stream.

Dual Stream and Bandwidth

Using Dual Stream, the quality will automatically downspeed to the optimal bandwidth. This means that you need higher quality to allocate enough bandwidth for the two video streams. Dual Stream borrows bandwidth from main video. When Dual Stream is closed, the bandwidth is returned to the main video.

Note that when selecting the Document Camera or PC, the system will automatically request floor when connected to a MCU conference as MultiSite host* or connected to an external MCU.

* Not available on all systems.

3.11.6 Take New Snapshot

The system can take a snapshot of your live video. Snapshot is handy when you are in a call with a system that does not support Dual Stream. Use Snapshot to show a snapshot of your presentation and continue the meeting with main camera.

How to use snapshot:

You find Take New Snapshot in the Presentation menu.

1. Select the Snapshot header.
2. Select Take New Snapshot and press OK to take a snapshot.

Snapshot is found on the Star key on the remote control.

1. Press Star and you take a snapshot of the current video source (current video is default snapshot source). You can change the snapshot source in Control Panel - Administrator Settings - [Presentation Settings](#). Note that snapshot does not work when you are in an input field in the menu (the star key is then used to write the star sign).

Note that Take New Snapshot is not possible when Dual Video Stream is activated and that it is only available when you are in a call.

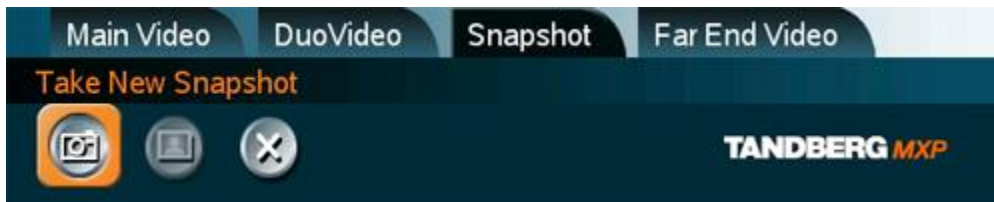

Note that the Snapshot feature uses H.261 Annex D and hence will not work when using H.264 video compression

3.11.7 Display Snapshot

The system stores the last sent or received Snapshot. The snapshot is deleted automatically after the call.

How to display snapshots:

1. To view a stored snapshot, first choose the Snapshot header.
2. Select Display Snapshot in the Presentation menu.
3. Press the Display Snapshot button again to deselect it. When disconnecting the call, the stored snapshot will be erased.

Receiving snapshots:

1. When receiving a snapshot, the snapshot is displayed in full screen.
2. Press OK to escape from the snapshot. The last sent or received snapshot will be stored in the graphics memory and erased once the call is disconnected.

Note that Display Snapshot is only available when you have a stored snapshot.

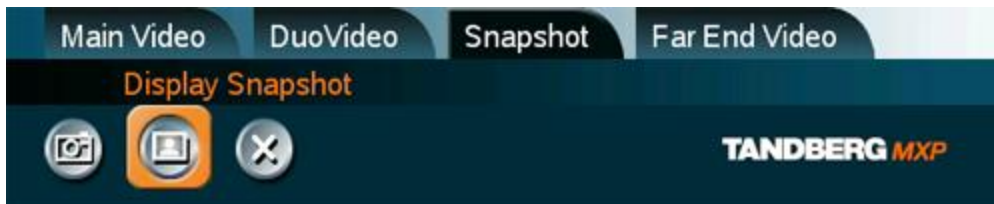

3.12 Conference Services

A Multipoint Control Unit (MCU) enables several sites to participate in the same conference. During an MCU conference, the status line will provide information about the conference.

You can make a multipoint conference in different ways. The Conference Services vary depending on how you make the call, see [Add call](#) for details.

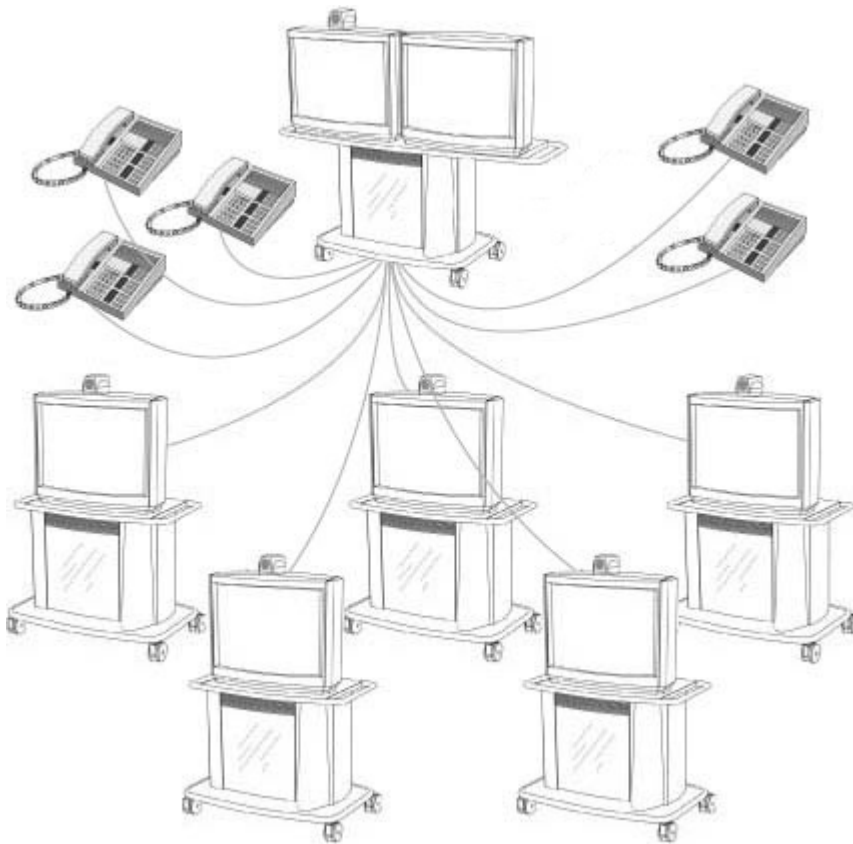

Example of MultiSite for high end systems

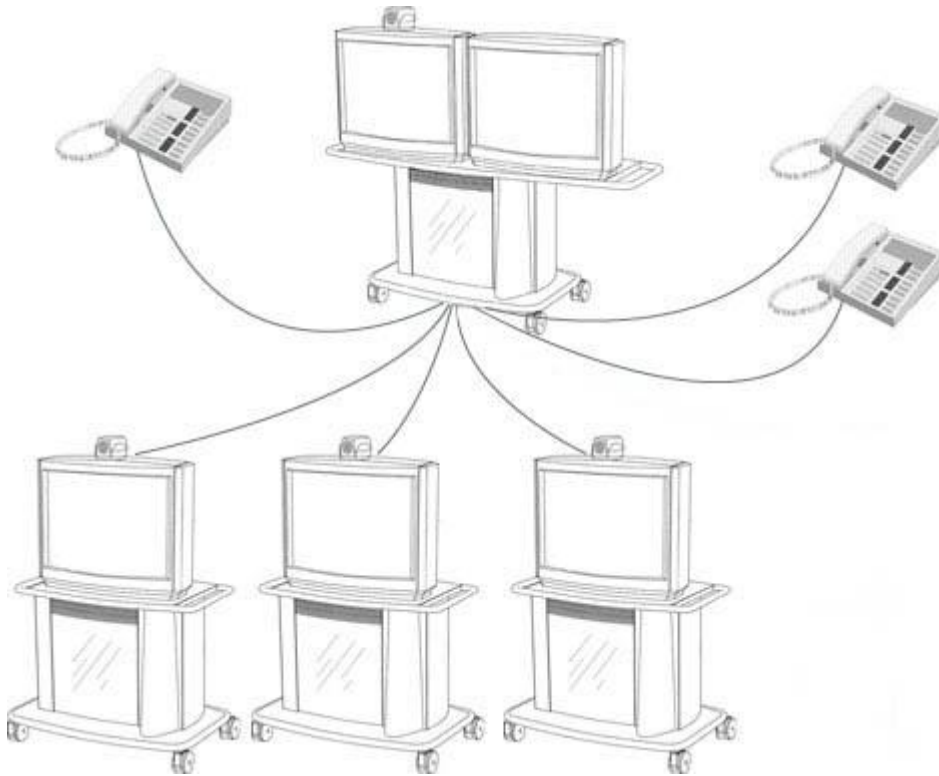

Example of MultiSite for mid- to low end systems

Using the system's internal MCU, MultiSite^{TF}*

Most TANDBERG MXP systems has an optional built-in MCU, which is called MultiSite*. It supports up to 6 video calls and 5 telephone calls including yourself for high-end systems, and 4 video calls and 3 telephone calls including yourself for the mid- and lower end systems. The MultiSite supports both Split Screen and Voice Switched mode. With MultiSite, you have the following services:

- Request/Release Floor
- Assign Floor To Participant/Release Floor From Participant
- Terminal Names
- Layout (Auto/4 Split/5+1 Split/Voice Switched)

Using an external MCU that supports Chair Control (H.243)

With an external MCU that supports H.243, you have the following services:

- Request/Release Floor
- View Participant/End View
- Chair Control

If you take Chair control, you get the following services:

- Release Chair
- Assign Floor To Participant/Release Floor From Participant
- Disconnect Participant
- Terminate Meeting

Using an external MCU with limited Chair Control Support you may have the following services

With an external MCU that does not support H.243, you have the following services:

- Request/Release Floor
- Terminal Names

* The MultiSite option is not available on the TANDBERG 550 MXP, TANDBERG 770 MXP and TANDBERG 1000 MXP

3.12.1 Request Floor and Release Floor

When requesting floor, your video will be broadcasted in full screen to all other participants in the conference. Request Floor is useful when you want to speak or display something in front of all participants.

Release Floor when you are done and make the floor available for other participants in the conference. An indicator appears when you have floor and disappears when you release floor, see floor indicator in [On-screen Indicators](#).

How to use Request and Release Floor:

1. Open the Main Menu by pressing OK.
2. Choose Conference Services and press OK.
3. Choose Request Floor and press OK. A Floor indicator will appear when you have floor.
4. When done, press the same button again, which now means Release Floor. The Floor indicator disappears.

3.12.2 Conference Layout

(Only supported by TANDBERG MultiSite*)

With a TANDBERG MultiSite you can choose between the layouts: Auto Split, 4 Split, 5+1 Split and Voice Switched view. Auto Split displays all participants on the screen simultaneously. 4 Split displays the 4 last speaking Participants including the MultiSite host. 5+1 Split displays the speaking participant in a big picture and the other participants in small pictures. Voice Switched mode displays the participant that is speaking in full screen. Switch between these picture modes using the Conference Layout menu.



Continuous Presence layout 4 split



Advanced Continuous Presence Layout (5+1).



Voice Switched mode

* The MultiSite option is not available on the TANDBERG 550 MXP, TANDBERG 770 MXP and TANDBERG 1000 MXP

3.12.3 Terminal Names

Choose Terminal Names to see a list of the participants of the MultiSite conference. Press Cancel to go back.

3.12.4 Chair Control

(Not supported by TANDBERG MCU, TANDBERG MPS or MultiSite)

As chairman, you have access to more MultiSite Services. Select Chair Control to assume the role of chairman of the conference. Select Release Chair to end the role as chairman. A Chair indicator appears when you have Chair and disappears when chair is released.

3.12.5 Assign Floor and Release Floor from Participant

Assign Floor allows the chairman to select which of the conference participants that is to be broadcasted to all other participants.

3.12.6 View Site and End View

(Not supported by TANDBERG MCU or MultiSite)

View Site allows you to view any participant in the conference regardless of whom having floor and chair. Choose End View to go back to normal.

3.12.7 Disconnect Participant

Disconnect Participant allows the chairman to disconnect any participant in the conference. In a multipoint call, this is equivalent to disconnecting a participant from the end call menu.

3.12.8 Terminate Meeting

Terminate Meeting allows the chairman to terminate the conference altogether. In a MultiSite call, this is equivalent to pressing End All Calls from the end call menu.

3.12.9 More about MultiSite (embedded MCU)

(Optional Feature*)

Calling in to a MultiSite

Any system can be part of a MultiSite conference by calling in to a MultiSite. The dial-in numbers to the MultiSite depends of the network that is used.

To dial in to the MultiSite on IP:

- Dial the IP Number or the IP Address of the system. All sites can dial the same number.

To dial in to the MultiSite on ISDN-PRI:

- Dial the ISDN number of the system. All sites can dial the same number.

To dial in to the MultiSite on ISDN-BRI:

- The MultiSite has specific numbers for each call that participates in the conference. To find the dial-in numbers for the MultiSite, choose Information from the main menu and open System Information from the bottom menu line.
- Site 2 must dial MultiSite Number 2.
- Site 3 must dial MultiSite Number 3.
- Site 4 must dial MultiSite Number 4.
- And so forth

Receiving calls to a MultiSite

When the MultiSite receives incoming calls you can accept or reject it. Pressing the green key is equivalent to pressing Accept. Pressing the red key is equivalent to pressing Reject.

End a MultiSite Call

Ending a MultiSite Call is not very different from ending a normal point-to-point call. Use the red key on the remote control or End Call from the main menu. The end call menu lists all the calls that participate in the conference. To end a single call, select the call, press OK or the red key on the remote control. To end all calls, press the End All Calls button in the menu.

Duo Video in MultiSite calls

In a MultiSite call, the MultiSite can transmit the Duo Video and/or H.239 to the other participants that support Duo Video and/or H.239. This means that any participant can send Dual Stream and the MultiSite will transmit it to the other participants. The participants that do not support Duo Video or H.239 will only receive Main Video or only the dual stream dependent on software options installed.

Mix ISDN/IP

A conference can consist of any combination of ISDN/IP sites.

* The MultiSite option is not available on the TANDBERG 550 MXP, TANDBERG 770 MXP and TANDBERG 1000 MXP

3.13 Control Panel



The Control Panel contains the features:

- [Diagnostics](#)
- [Text Chat](#)
- [Audio Demonstration](#)
- [Administrator Settings](#)
- [Restart](#)
- [User Guide](#)

3.13.1 Diagnostics

Diagnostics allows testing of individual system components and displays the current system settings.



Diagnostics contain:

- [System Information](#)
- [Call Status](#)
- [Channel Status](#)
- [System Selftest](#)
- [View Administrator Settings](#)
- [IP Address Conflict Check](#)
- [Warnings](#)

3.13.1.1 System Information

Select System Information to view system numbers, line status, software version, hardware serial number and other useful information. Press arrow key up and down to scroll in the System Information list.

System Information contains:

System Name	Software Version	Network	Hardware Serial Number
My ISDN Number	Internal Test	Lines active	MAC address
My IP Number	Software Options installed	Lines not active	Ethernet Speed
My IP Address			
MultiSite number			
2			
MultiSite number			
3			

Note that the serial number is also found on a sticker on the system. It is essential for identifying the system when it comes to service contracts or other support activities. The serial number format is xx.xxxxx.

3.13.1.2 Channel Status

Comprehensive information about the call progress is available through the Channel Status window. This window indicates the various stages each B-channel goes through whilst establishing a connection.

Status - BRI	Comments
Idle	the channel is idle
Calling	when calling — the network has acknowledged the call
Connected	when connection is established
Sync	when the channels are synchronized
Active	when all available channels are connected
Releasing	waiting for the network to confirm a release of the call
Released	when disconnected - the network has acknowledged the disconnection

Cause codes

The most common cause codes (for ISDN) are:

1	Unallocated (unassigned) number
2	No route to specified transit network (WAN)
16	Normal clearing
17	User busy
18	No user responding
21	Call rejected
28	Invalid number format (incomplete number)
29	Facility rejected
31	Normal, unspecified
34	No circuit/channel available
41	Temporary failure
58	Bearer capability not presently available
65	Bearer service not implemented
69	Requested facility not implemented
81	Invalid call reference value
88	Incompatible destination
100	Invalid information element contents
102	Recovery on timer expiry
127	Internetworking, unspecified
255	TANDBERG specific. undefined cause code

3.13.1.3 Call Status

Comprehensive information about the call is available through the Call Status window. The menu has two columns, one for transmitted and one for received audio/video/data information. If Dual Stream or MultiSite is available on your system and in use, pressing the UP/DOWN keys will show one page per connected site. Some of the information fields will vary dependent on if H.320 (ISDN calls) or H.323 (IP calls) are made.

3.13.1.4 System Selftest

The system performs a check to determine internal hardware integrity. System Selftest is useful when you want to check if your network connection is active.

3.13.1.5 View Administrator Settings

This window displays all the system settings. Use the arrow key on the remote control to scroll through the list.

View Administrator Settings may contain*:

General Settings	System Name Language Dual Monitor Auto answer Max Call Length Access Code Incoming MCU calls Incoming Telephone calls Far End Control Fallback to Telephony
Screen Settings	TV Monitor Format Picture Layout VGA Monitor Format VGA Out Quality PC Picture Format Allow VGA 50Hz
Software Options	Options Installed Serial Number Current Option Key
Menu Settings	Menu Timeout in Call Welcome Menu Welcome Picture Logo Balloon Help Display Welcome Text Welcome Text Administrator Password
Presentation Settings	Duo Video Mode Start up Video Source Presentation Source Snapshot Source Auto Display Snapshot PIP Appearance PIP Placing
VNC Settings	Address Display Number Call Quality Video Algorithm Audio Algorithm Interlaced
Video Quality	Main Camera

	PC Document Camera VCR AUX VNC Split Screen
Default Call Settings	Call Type Network Bandwidth Restrict (56k) Auto H320 Bandwidth Auto H323 Bandwidth SIP
Audio Settings Inputs	Mic1 Mic2 Mic3 Audio4 Audio5 Audio6 Mix Mode VCR Ducking
Level Settings	Mic1 Mic2 Mic3 Audio4 Audio5 Audio6
Outputs	Out1 Out2 (AUX) Out3 (VCR) Out1 Mode
Level Settings	Out1 Out2 (AUX) Out3 (VCR)
Echo Control	Mic1 Mic2 Mic3 Audio4
Audio Levelling (AGC)	Mics Audio5 (AUX) Audio6 (VCR) Received Audio
Alert Tones & Volume	Video Call Alert Tone Telephone Alert Tone Alert Volume Alert Speaker Key Tones
Video Settings	Camera Tracking Mode MCU Status Line Web Snapshot MultiSite Picture Mode
Picture Control	Focus

	White balance Brightness
Video Name	Main Cam AUX Doc Cam VCR PC VGA VNC
Network Type	ISDN-BR\PRI\Leased E1\T1\External H331 ISDN Switch Type ETSI (Euro ISDN),... Line1 Setup On Number1 Number2 SPID1 SPID2 Line2 Setup On Number1 Number2 SPID1 SPID2 Line3 Setup On Number1 Number2 SPID1 SPID2
Advanced ISDN Settings	Subaddress Validate Numbers (MSN) Parallel Dial Send Own Numbers Sending Complete
ISDN-PRI Settings	Number Range ISDN-PRI Switch Type
Channel Hunting	Max Channels Low Channel High Channel Search High, Low Line Settings: T1 Cable Length 1 T2 Cable Length 2 E1 CRC-4
Advanced ISDN PRI Settings	NSF Code Video NSF Code Telephone Call
Leased E1/T1 Settings	Call Control Network Interface Max Channels Start Channels T1 Line Coding Line Settings
External network configuration	Call Control RS66 RS449/V.35 Compatible
IP Settings	IP assignment

	IP address IP subnet mask Gateway Ethernet Speed
H.323 Settings	E.164 Alias Use Gatekeeper Gatekeeper IP H.323 Prefix
Advanced H.323 Settings	RSVP NAT NAT Address QoS
IP Precedence	Audio Video Data Signaling IP Type of Service (TOS)
Diffserv	Audio Video Data Signaling
SNMP Settings	SNMP Trap Host1 SNMP Trap Host2 SNMP Trap Host3 SNMP Community
Streaming Settings	Address Address Port TTL/Router Hops Streaming Source Allow Remote Start Announcements Video rate (kbps)
Network Profiles	Auto H.320 H.323 Network Profile 4 Network Profile 5 Network Profile 6
Security	Encryption Encryption mode
Data Port 1	Baud rate Parity Databits Stopbits Mode
Data Port 2	Baud rate Parity Databits Stopbits Mode

* The administrator settings available will vary within the MXP system range depending on system and what software options installed.

3.13.1.6 IP Address Conflict Check

The system will give a warning if there is an IP conflict. The user may initiate this check by selecting IP Address Conflict Check.

3.13.1.7 Warnings

If any warnings registered by the system it will be displayed in the Warnings menu. Open a warning in the list to get more information about the warning.



The following warnings are displayed if detected by the system:

ISDN BRI warnings

- ISDN is enabled on BRI line x, but the line is not connected. Please check your network connection or disable the line. (101)
- There is something wrong with ISDN BRI line x. Please check your network connection. (102)

IP network quality warnings

- The system is experiencing packet loss in the IP network. This may affect the quality of the call.
- The system is experiencing high jitter in the IP network. This may affect the quality of the call.
- The system is dropping IP packets due to latency in the network. This may affect the quality of the call.

ISDN PRI warnings

- ISDN PRI is configured for this system, but the line is not connected. Please check your network connection or disable the network. (131)
- There is something wrong with the ISDN PRI line (Blue alarm). Please check your network connection. (132)
- There is something wrong with the ISDN PRI line (Yellow alarm). Please check your network connection. (133)
- There is something wrong with the ISDN PRI line (D-Channel not active). Please check your network connection. (134)

External Network warnings

- External Network is configured for this system, but the line is not connected. Please check your network connection or disable the network. (161)

Leased E1/T1 warnings

- Leased E1/T1 is configured for this system, but the line is not connected. Please check your network connection or disable the network. (191)
- There is something wrong with the Leased E1/T1 line (Blue alarm). Please check your network connection. (192)
- There is something wrong with the Leased E1/T1 line (Yellow alarm). Please check your network connection. (193)

H323 gatekeeper warnings

- Could not register to the gatekeeper.
- The gatekeeper rejected to register the system. Another system is already registered with the same alias or H.323 ID.
- The max capacity on the gatekeeper is reached. Registration failed.
- Tried to register to the gatekeeper without a valid alias. Registration failed.
- The system is not allowed to register with this gatekeeper.
- Can not find the gatekeeper. Check the gatekeeper configurations on the system.

3.13.2 Text Chat

While in an ISDN or IP call to another system supporting Text Chat (T.140), select Text Chat from the Control Panel. Enter text in the displayed window.

How to use Text Chat:

1. Choose Text Chat from the Control Panel to open the Text Chat window.
2. Enter text with the number keys like on a mobile phone. The text is sent to the far end continuously letter by letter.
3. Press OK to end Text Chat and escape from the text chat window.

Note that Text Chat is supported in point to point calls only.

3.13.3 Audio Demo

Note that the Audio demo will only appear in the User Guide if a Digital Natural Audio Module is connected to the codec.

3.13.4 Administrator Settings

Administrator Settings contains the configuration of the whole system. It is recommended to password protect Administrator Settings to prevent occasional users to make changes to the system. See [Administrator Settings](#) for further details.

3.13.5 Restart

Restart the system by pressing the Restart button. You are prompted with a dialog box saying: Do you want to restart the system? Press OK to restart, press Cancel (X) to abort.

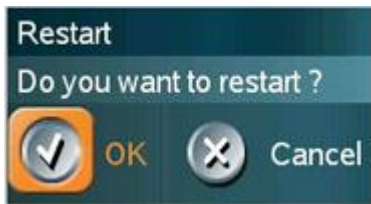

3.13.6 User Guide

The on screen user guide takes you through a quick step-by-step introduction to videoconferencing. It gives the user basic skills in how to use the system.



4 Administrator Settings



Administrator Settings contain all the settings of the system. Making changes to Administrator Settings will change the behavior of the system. It is recommended to password protect the access to Administrator Settings to prevent occasional users from making crucial changes to the system, see [Administrator Password](#).

Administrator Settings contain:

- [General](#)
- [Menu Settings](#)
- [Presentation Settings](#)
- [Call Quality](#)
- [Audio](#)
- [Video](#)
- [Security](#)
- [Network](#)
- [Restore Default Settings](#)

4.1 General Settings

When installing the system, go through the General Settings menu to ensure that you have the right settings for your system, see System Configuration.



General Settings contain:

- [Language](#)
- [System Name](#)
- [Autoanswer](#)
- [Max Call Length](#)
- [Phone Book Settings](#)
- [Permissions](#)
- [Screen Settings](#)
- [Software Options](#)

4.1.1 Language

The system supports 15 different languages for its on-screen menus; English, German, French, Norwegian, Swedish, Italian, Spanish, Portuguese, Chinese Simplified, Chinese Traditional, Japanese, Russian, Korean, Finnish and Thai. Select the preferred language and press OK to save.

4.1.2 System Name

System Name identifies the system:

- On the welcome page.
- During an MCU conference call.
- When using the Web-interface.
- When the codec is acting as an SNMP Agent.
- Towards a DHCP server.
- H323 ID. Other systems can call in using this name instead of IP-number/IP-address.

System Name is blank by default. System name can be alphanumeric and up to 50 characters long. Follow the installation procedure to enter a System Name.

4.1.3 Auto Answer

The auto answer setting decides whether an incoming call is put through automatically or manually.

On	The system will automatically answer all incoming calls.
On+Mic Off	The system will automatically answer all incoming calls and switch the microphone off when the call is connected. Press Mic Off to switch the microphone on.
Off	You must manually answer all incoming calls by pressing OK or the Call key.

4.1.4 Max Call Length

This feature will automatically end both incoming and outgoing calls when the call time exceeds the specified Max Call Length. Max Call Length can have the following values: 0-999 (minutes), where 0 means off.

4.1.5 Phone Book Settings

Phone Book

On	Phone Book is available in the menu.
Off	Phone Book is hidden from the menu and is unavailable for users.

IP address

Enter the IP address of the management system that provides the Phone Book.

Path

The Path indicates the function of the management system.

4.1.6 Permissions

Permissions contains settings for incoming MCU Calls, incoming telephone Calls, Far End Control, Remote Software Upgrade and Fallback to Telephony.

Access Code

An access code will help you control the use of the system. All users must enter a code to identify themselves and the call will be charged on their account. Access Codes are handy for group systems where there are more users or divisions that share the costs of using the system. Access Code can be set to "On" and "Off". Please refer to section [Appendix 5](#) for more information on Access codes.

On	When making a call, an Access Code dialog box will be shown. The user must enter the correct password in order to put the call through.
Off	No password is necessary to make a call.

Incoming MCU Calls

On	When you are in a call, the system will provide visual and audible indications of an incoming call and ask you to accept/reject the call.
Off	The system will not accept incoming calls when you are in a call.

Incoming Telephone Calls

On	The system will accept incoming telephone calls.
Off	The system will not accept incoming telephone calls. This is useful to prevent incoming calls from systems other than videoconferencing systems.

Far End Camera Control

On	The far end will be able to: <ul style="list-style-type: none"> • Control your camera • Select your video sources • Activate your camera presets • Request snapshots
Off	The far end can access none of the four features above on the local system. You will however still be able to control the camera on the far end.

Remote Software Upgrade

It is possible to upgrade software remotely, i.e. a far end system may upgrade software on a local system via http on ISDN. The system to be upgraded must be configured to allow remote software upgrade. It is possible to set a password which is needed for the far end system to be able to accomplish the software upgrade.

On	The system will allow a remote system to upgrade local software.
Off	The system will not allow a remote system to upgrade local software.

Note that the configuration can also be done via the telnet or the serial port.

Fallback to Telephony

When dialing a number and the system fails to place a video call to the number dialed, the system will attempt to place a telephone call if Fallback to Telephony is enabled.

On	Enables fallback from video calls to telephone calls.
Off	Disables fallback.

4.1.7 Screen Settings

Auto Layout

On	If Auto Layout is On the system will change layouts automatically depending on the number of participants in a call and if you have a dual video stream or not. Please refer to Layout for more information.
Off	If Auto Layout is Off there will be no automatic layout changes during a call. All desired layout changes must be done manually.

Note that when you receive low resolution images (176x144 pixels or less) the screen will automatically adjust to a smaller view to give optimum quality experience.

Use Screen as Local PC Monitor

Use the Selfview button to switch from local PC display to standard conference layout.

On	If Local PC Display is On you will be able to have Local PC displayed both outside a call and in a call.
Off	If Local PC Display is Off you will not be able to see a Local PC image.

Please refer to [Local PC Display](#) for more information.

Picture Layout

The Advanced Picture Layout is related to the Layout button on the remote control and it can be used at any time to change the screen layout. For wide screen systems POP mode is recommended. You will get optimized picture layouts for wide screen by pressing the Layout button on the remote.

Picture in Picture (PIP)	Pressing the Layout button on the remote will result in an extra picture in smaller view (Picture in Picture). Press the Layout button to move it around in the corners of the screen and finally hide it. Pressing and holding Layout for 1 second will hide the small picture directly from any position.
Picture outside Picture (POP)	Press the Layout button to see the images side-by-side, e.g. 1+1 layout, where the far end and near end are displayed as images of equal size, see figure below.

Press the Layout button once more to change to 1+2 layout. The far end image will be displayed as the main video, with the near end, usually the user of the system, as a smaller image in the upper right corner. If Duo Stream is used, the Dual Stream image is displayed as the main image and the far end and near end as smaller images to the right, see figure below for an example.

Press the Layout button again to get the 1+3 layout.

The next time the Layout button is pressed, the normal full screen view of the far end is displayed. Pressing and holding **Layout** for 1 second will always bring you back to full screen.

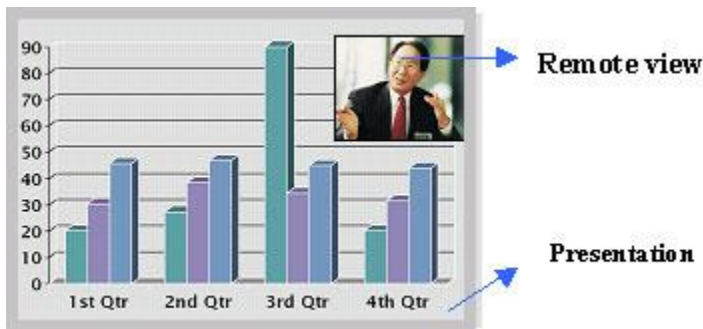

Example of Picture in Picture.

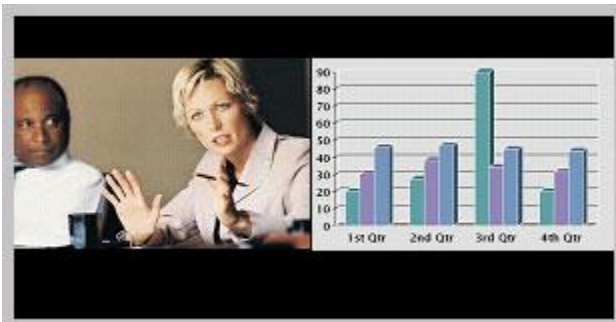

Example of 1+1 Side-by-Side view (wide screen).

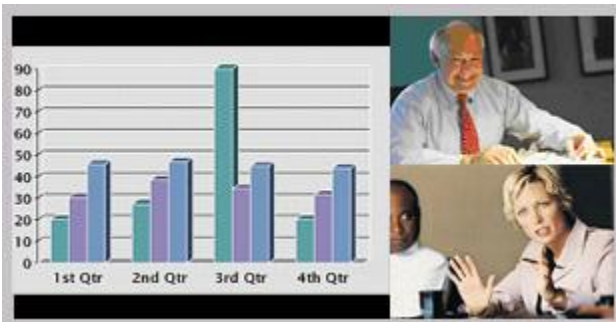

Example of 1+2 Picture outside Picture (wide screen).

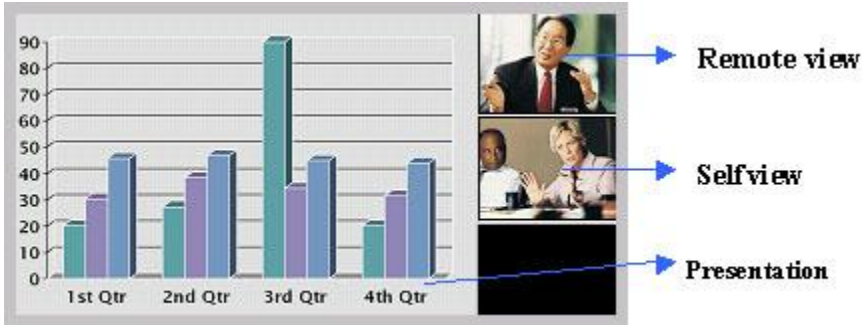

Example of 1+3 Picture outside Picture (wide screen).

Note that the following menu settings do not apply for all TANDBERG MXP systems. Please refer to the actual menu page on your system.

VGA Monitor Format

To fully leverage your wide screen display, activate the Native 16:9 format by setting the VGA Monitor Format to Wide. Note that you should only change this setting if your VGA monitor is a wide screen (16:9) monitor or projector. The VGA and DVI output will then be optimized for Wide Screen VGA and High Definition (HD) display.

Normal	Output format is optimized for Normal VGA monitors (4:3)
Wide	Output format is optimized for Wide VGA monitors (16:9)



Wide screen VGA or TV monitor in Normal (stretched) mode.



Wide screen VGA or TV monitor In Wide (native) mode.

VGA Out Quality*

The supported range of VGA formats will be optimized for the VGA display monitor based on the source image.

VGA Out Quality enables the user to change the preferred format for the DVI/VGA output. It is recommended to keep this setting in Auto unless your screen doesn't support some of the XGA or SVGA formats the system is using. Note that the VGA Out port support VESA Power Management.

Auto	VGA output format will be optimized dependant of the video source format, refresh and of the EDID information available. Supported formats are: SVGA (800x600) 75Hz XGA (1024x768) 60Hz / 75Hz WXGA (1280x768) 60Hz
SVGA 800x600 75Hz	VGA output format is forced to SVGA format (800x600) 75Hz
XGA 1024x768 60Hz	VGA output format is forced to XGA format (1024x768) 60Hz

VGA Out Quality for Wide XGA:

If VGA Monitor Format is set to Wide, PC Picture Format is set to Normal, VGA Out Quality is set to Auto, the layout on the monitor is either fullscreen or POP, and the input source to the largest window is PC with resolution 1024x768, the system will use WideXGA (1280x768) instead of XGA, when the monitor supports this.

* Not supported on the TANDBERG 2000 MXP

PC Picture Format (wide screen monitors only)

PC Picture Format setting only takes effect when TV or VGA Monitor Format is set to Wide. Use this setting to determine if you want your PC presentations to be shown stretched in full screen, or with correct aspect ratio using part of the widescreen display. With the VGA Out Quality set to Auto the presentation will be of the best possible quality supported by the monitor.

Normal VGA output will have 4:3 aspect ratio on wide screen monitor.

Wide VGA output will utilize the wide screen monitor at full.

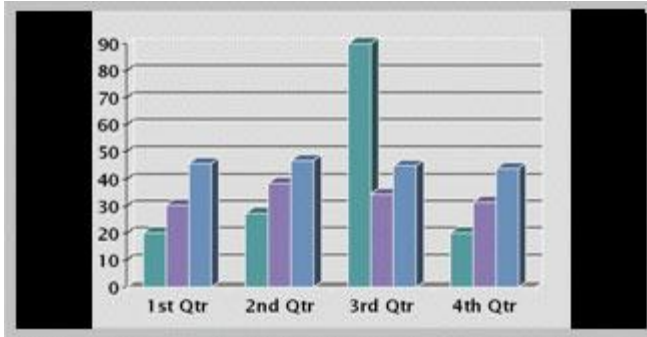

PC presentation shown in Normal (correct ratio) mode.

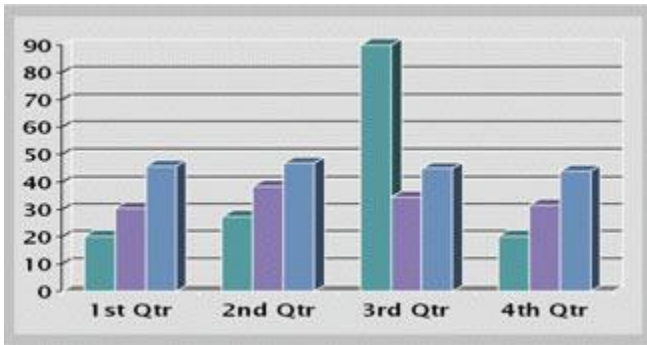

PC Presentation shown in Wide (stretched) mode.

4.1.8 Software Options

The system requires a valid option key to activate MultiSite and/or Presenter functionality. In order to activate additional bandwidth, you need to enter a bandwidth key. A restart of the system is required after entering a new option and/or bandwidth keys. If the key is invalid, the original key will be used.

The following options are available:

1. No option
2. Presenter
3. MultiSite + Presenter
4. Bandwidth options

4.2 Menu Settings

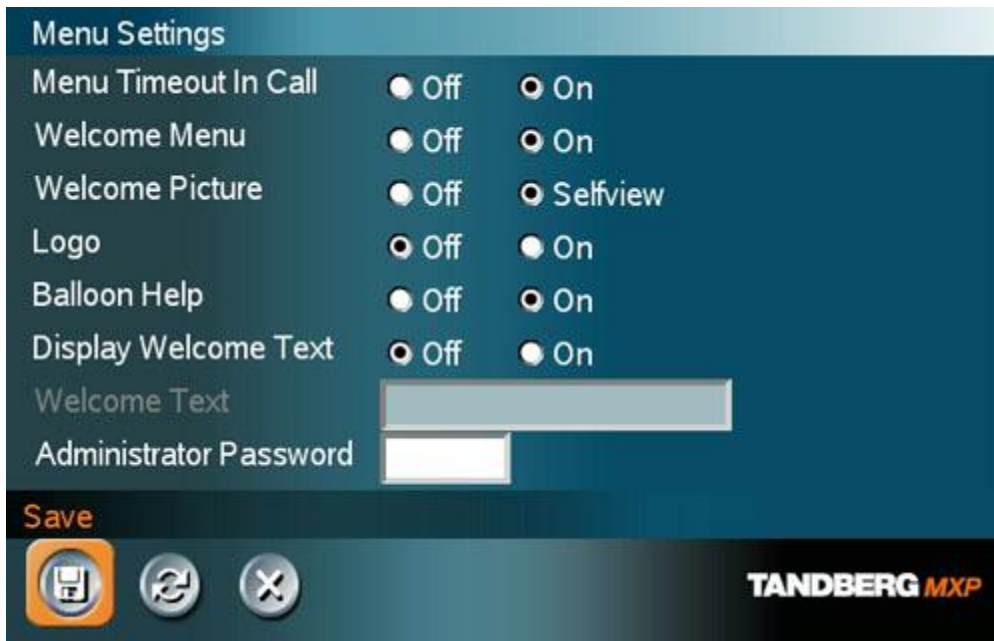

Menu Settings contain the settings:

- [Menu Timeout In Call](#)
- [Welcome Menu](#)
- [Welcome Picture](#)
- [Logo](#)
- [Balloon Help](#)
- [Display Welcome Text](#)
- [Welcome Text](#)
- [Administrator Password](#)

4.2.1 Menu Timeout In Call

Main menu appears on the bottom line of the screen. Set Menu Timeout In Call to On if you want the menu to time out automatically when you are in a call.

On	The menu will time out automatically after 15 seconds if there is no activity on the remote control. Menu timeout does only apply when you are in a call. Outside a call, the menu will not time out.
Off	The menu will not time out automatically. Press Cancel (X) to hide the main menu manually.

4.2.2 Welcome Menu

The Welcome Menu contains the Main Menu, System Status, your System Name and dial in numbers.

On	The Welcome Menu is shown when the system wakes up from standby mode.
Off	The Welcome Menu is not shown when the system wakes up from standby mode. Press the OK button to open the welcome menu.

4.2.3 Welcome Picture

The Welcome Picture is what you see in the background of the welcome menu.

Selfview	Selfview is shown in the background of the welcome menu. In most cases this means that main camera is displayed and you can see the video image of yourself.
Off	No picture is shown in the background of the welcome menu.

4.2.4 Logo

It is possible to upload a company logo to the system. For more information about how to upload a Logo, see [Appendix 6](#). Set the Logo settings to On to display the logo.

On	Choose On if you want the company logo to appear in the background of the welcome menu.
Off	The logo is not displayed.

Note: The TANDBERG Logo will be displayed if no other company logo is load and logo is enabled.

4.2.5 Balloon Help

It is possible to enable / disable the balloon help window.

On	Choose On if you want help text windows to appear.
Off	There will be no help text window.

4.2.6 Display Welcome Text

The welcome text displays your system name and dial in numbers by default. It is possible to hide this information by choosing Display Welcome Text Off.

On	Welcome text is displayed on the welcome menu.
Off	Welcome text is not displayed on the welcome menu.

4.2.7 Welcome Text

You can change the welcome text to any text you like, instead of the default text. Remember that Display Welcome Text must be On to be able to edit the welcome text.

4.2.8 Administrator Password

It is recommended to put an Administrator Password on the system. The Administrator Password can be maximum 5 digits long. The Administrator Password dialog box will pop up when you choose Administrator Settings from the Control Panel. This will prevent occasional users from going in to administrator settings. With an administrator password, you can ensure that your system will behave in the same way every time and that only dedicated people are allowed to make changes to the system.

4.3 Presentation Settings



Presentation Settings contain:

- [Presentation Start](#)
- [H.239](#)
- [Call Video Source](#)
- [Presentation Source](#)
- [Snapshot Source](#)
- [Auto-Display Snapshot](#)
- [PIP Appearance](#)
- [PIP Placing](#)
- [VNC Settings](#)

4.3.1 Presentation Start

If your system has Dual Stream capabilities, you can show two video streams at the same time (see also [Dual Stream](#)). Presentation Start is Auto by default. This means that you will start Dual Stream (a second video stream) automatically when starting a presentation. Dual Stream requires the Presenter Option and H.263 video. To check which options are installed, see the System Information menu in Control Panel.

Manual means that you manually choose if you want to start Duo Video or not every time you start a presentation.

Auto	Dual Stream starts automatically when you start a presentation (in other words, when you choose a second video source). If your system or the far end system is not capable of Duo Video/H.239, you will not use Dual Stream, but rather send the presentation source as your Main Video
Manual	When starting a presentation, select Presentation in the call menu and select Start Presentation. Choose a video source from the list displayed on the screen.

4.3.2 H.239

H.239 supports transmission of two video streams. It combines elements of Duo Video and People+Content. If H.239 is disabled you will still be able to start TANDBERG Dual Video Stream*

Enabled	Enables H.239
Disabled	Disables H.239

* The TANDBERG 550 MXP can only receive Dual Video Stream.

4.3.3 Call Video Source

The Call Video Source is the default video source you would like to use in a call. If you use Main Camera as Call Video Source, the system will start with Main Camera every time you make a call, regardless of what the previous video source was.

Example: What is the advantage of setting Call Video Source to Main Camera?

When you are not in a call, you can work with the screen as a normal PC screen. When you make a video call, the system will automatically change to Main Camera. When you receive a call, the system will also automatically change to Main Camera, preventing that the caller will see your PC image.

You can change Call Video Source to Main Camera, PC or Current. Choosing Current will result in the last used video source.

4.3.4 Presentation Source

The Presentation Source is connected to the Presentation button on the remote. Pressing the Presentation button will put the Presentation Source on display. Presentation Source is PC by default*. You can change the Presentation Source to any video source and none. Choosing none results in opening the Presentation menu when pressing the Presentation key.

* Only for systems with the PC video input available.

4.3.5 Snapshot Source

When you take a Snapshot, you get a snapshot of the Snapshot Source. Current is the default Snapshot Source. This means that you take a snapshot of the video source that is currently active.

You can change the Snapshot Source to any video source. In this way you can program the snapshot key to apply only for PC for instance. Press Snapshot and you will take a PC snapshot regardless of what video source that is currently active.

4.3.6 Auto-Display Snapshot

Select Auto to automatically display a received snapshot. Turn Auto-Display Snapshot Manual if you wish not to have them displayed on the screen when they are sent or received. The snapshots will be sent and received, but not displayed. With Auto-Display Snapshot set for Manual, you must enter the Presentation menu to display a snapshot.

Auto	A sent or received snapshot will automatically be displayed on the screen.
Manual	A sent or received snapshot will not be displayed on the screen. To see the snapshot, choose Display Snapshot in the Presentation menu.

4.3.7 PIP Appearance

A Picture in Picture (PIP) is a smaller picture placed in one of the corners of the screen. The PIP enables you to see an extra picture in your video conference.

Auto	PIP Auto means that Picture In Picture will appear automatically when it is suitable. A picture in picture is nice when you use Duo Video and you need an extra window to see all the pictures. You can of course show or hide the PIP with the Layout button on the remote anytime.
On	PIP On means that a Picture in Picture will always be displayed.
Off	PIP Off means that PIP is not displayed automatically.

4.3.8 PIP Placing

PIP Placing lets you decide where the PIP shall appear. You can of course move the PIP with the Layout button on the remote anytime.

Top Right	PIP is placed in the Top Right corner.
Bottom Right	PIP is placed in the Bottom Right corner.
Bottom Left	PIP is placed in the Bottom Left corner.
Top Left	PIP is placed in the Top Left corner.

4.3.9 VNC Settings

VNC Settings is necessary when using a VNC presentation. See chapter PC Soft Presenter and VNC for more information on how to use VNC.

Address	The IP-address of the PC with the VNC software installed. To find the IP-address of the PC, place the mouse pointer on the VNC program icon in the lower right corner of the Windows taskbar. You can also select Command Prompt from the Startup-menu\Run and type cmd then enter. This will open a command window and from here. Type "ipconfig" and press enter.
Display Number	The display number for VNC is 0 and upwards. If you are using WinVNC, double-click on the icon on the taskbar to view WinVNC properties. This number should correspond with Display Number in this menu.
Password	Enter the same password as specified in WinVNC properties. The password will be shown as asterisk signs (*) the next time you enter the menu.

4.4 Call Quality

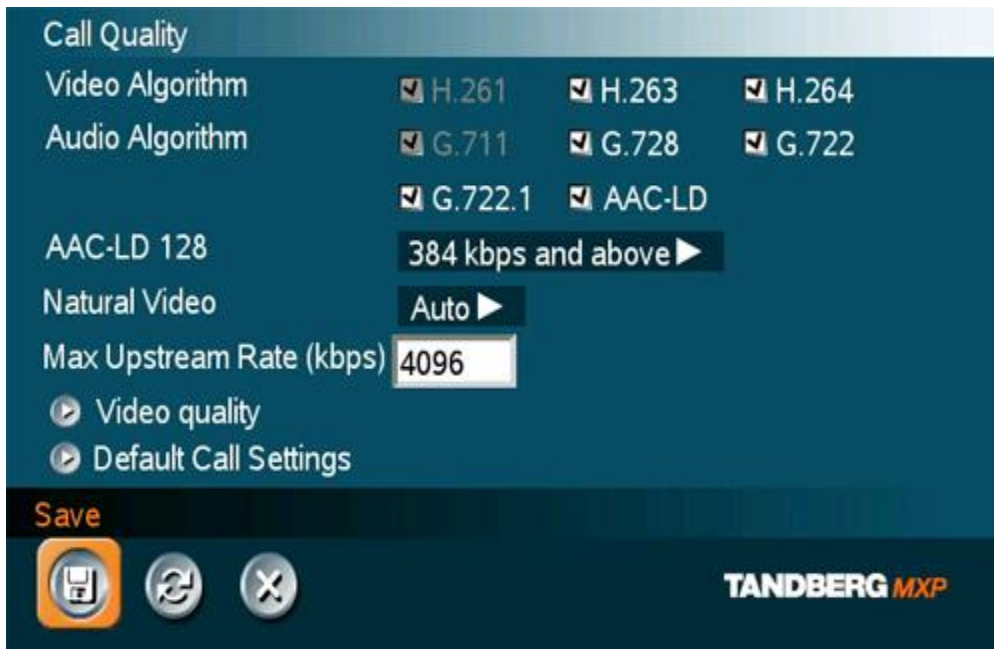

Call Quality contains the settings:

- [Video Algorithm](#)
- [Audio Algorithm](#)
- [AAC-LD 128kbps](#)
- [Natural Video](#)
- [Max Upstream Rate](#)
- [Video Quality](#)
- [Default Call Settings](#)

4.4.1 Video Algorithm

The system will automatically select the best video algorithm based on the video source and the capabilities of the remote system. Use this menu to disable video algorithms in case you have interoperability issues calling other systems.

H.264	Bandwidth efficient video compression and decompression.
H.263	Normal video compression and decompression.
H.261	Legacy video compression and decompression. The system will always have H.261 enabled. Therefore it is impossible to uncheck H.261.

4.4.2 Audio Algorithm

The system will automatically select the best audio algorithm based on the call rate and the capabilities of the remote system. Use this menu to disable audio algorithms in case you want to remove “low quality” audio, or if you have interoperability issues calling other systems.

G.722	High quality audio (7 kHz at 48kbps, 56kbps or 64kbps)
G.728	Compressed normal quality audio (telephone quality, 3.1 kHz at 16kbps)
G.711	Normal quality audio (telephone quality 3.1kHz at 64kbps). This audio algorithm is mandatory for video conferencing equipment and is impossible to uncheck.
G.722.1	Compressed high quality audio (7 kHz at 24kbps, 32kbps and 48kbps).
AAC-LD	CD-quality audio, MPEG-4 Advanced Audio Coding Low Delay (20 kHz, stereo at 128kbps, mono at 64kbps).

Call Rate vs Audio algorithms selected

Modify/remove algorithms used by unchecking the different audio algorithms.

Automatically preferred audio algorithms on call rates up to and including 192kbps

1. G.722.1 (24kbps or 32kbps)
2. G.728 (16kbps)
3. AAC-LD (64kbps or 56kbps)
4. G.722 (56kbps, 64kbps or 48kbps)*
5. G.711 (64kbps, 56kbps or 48kbps)**
6. AAC-LD (48kbps or 128kbps)

Automatically preferred audio algorithms on call rates above 192kbps

1. AAC-LD (128kbps)***
2. AAC-LD (64kbps or 56kbps)
3. G.722 (64kbps, 56kbps or 48kbps)*
4. G.722.1 (32kbps or 24kbps)
5. G.728 (16kbps)
6. G.711 (64kbps, 56kbps, 48kbps)**
7. AAC-LD (48kbps or 128kbps)

* G.722 at 64kbps is used in H.323 (IP) calls only.

** G.711 at 64kbps is used in SIP and H.323 (IP) calls only.

*** Dependent on a call rate above the AAC-LD 128 threshold. Note that this is not available on all TANDBERG systems.

4.4.3 AAC-LD 128kbps (stereo audio)

Specify a call rate for 128kbps AAC-LD. From this call rate and above, "128kbps AAC-LD" is available. On lower call rates "64kbps AAC-LD" is available.

Stereo audio requires twice the bandwidth as mono CD-quality audio. Therefore we recommend to enable stereo audio on high call rates only. To enable stereo CD-quality audio you need to specify a call rate for when stereo automatically should be enabled. On lower call rates, mono CD-quality audio "64kbps AAC-LD" will be enabled. Stereo Input mode needs to be enabled to get stereo audio, see [Stereo Settings](#) for details.

4.4.4 Natural Video

Choosing Natural Video will enable 60 fields* per second true interlaced picture for high motion video. The use of Natural Video requires the H.263+ and H.263++ video protocols. Natural video will be disabled in H.323 MultiSite calls and in H.320 Continuous Presence MultiSite calls.

Auto	Natural Video Auto will enable transmission of Natural Video from 768 kbps and above. Reception of Natural Video is in this case always enabled.
Off	Natural Video Off will disable both transmission and reception of Natural Video.
Custom	384 kbps and above to 1920 kbps and above.

** 50 fields per second on PAL systems.*

4.4.5 Max Upstream Rate (kbps)

The Max Upstream Rate (kbps) defines the desired maximum transmitted call rate. This is to be able to limit the outgoing bandwidth whilst keeping the maximum incoming bandwidth, especially useful for home offices with different upstream and downstream rates, typically ADSL.

4.4.6 Video Quality

The different video sources need different Video Quality Settings. Main Camera, VCR, AUX and Split Screen have Motion as default. PC, Document Camera and VNC have Sharpness as default.

Motion	Optimized for smooth motion video (CIF/SIF for low bandwidths, iCIF/iSIF for high bandwidths).
Sharpness	Optimized for sharp video (4CIF/4SIF, SVGA, XGA).
Auto	The system chooses the best of Motion or Sharpness depending on picture layout and bandwidth.

4.4.6.1 Intelligent Video Management (IVM)

It is possible to configure the picture sent from the system depending upon specific requirements and applications adding an additional level of flexibility and adaptability.

Generally, the IVM will always try to transmit the format closest to the video input format. Each video input can be configured to either motion or sharpness:

Motion: When there is a need for higher frame rates, typically when a large number of participants are present or when there is a lot of motion in the picture.

At low bit rate:

- CIF will be used from a PAL video input
- SIF from NTSC
- VGA/SVGA/XGA from PC, Digital Clarity

At high bit rate:

- iCIF will be used from a PAL video input, Natural Video
- iSIF from NTSC, Natural Video
- VGA/SVGA/XGA from PC, Digital Clarity

Sharpness: Improved quality of detailed images and graphics, lower frame rate, ideal for enhancing quality at lower bandwidths.

- 4xCIF will be used from a PAL video input, Digital Clarity
- 4xSIF from NTSC, Digital Clarity
- VGA/SVGA/XGA from PC, Digital Clarity

IVM Resolution

The following table shows relationship between Transmission modes selected by the system when Motion or Sharpness is set in the Call Quality menu. IVM will use this table to optimize the Video quality, according to the capabilities of the remote system(s):

Basic Video Quality	Video Input	Transmission mode selection rules
MOTION	PAL	iCIF@50 -> CIF -> QCIF
MOTION	NTSC	iSIF@60 -> iCIF@60 -> SIF@60 -> CIF -> QCIF
MOTION	VGA	CIF -> QCIF
MOTION	SVGA	CIF -> QCIF
MOTION	XGA	CIF -> QCIF
SHARPNESS	PAL	4xCIF -> VGA -> CIF -> QCIF
SHARPNESS	NTSC	4xSIF -> 4xCIF -> VGA -> SIF -> CIF -> QCIF
SHARPNESS	VGA	VGA -> 4xCIF -> CIF -> QCIF
SHARPNESS	SVGA	SVGA -> 4xCIF -> VGA -> CIF -> QCIF
SHARPNESS	XGA	XGA -> SVGA -> 4xCIF -> VGA -> CIF -> QCIF

Transmission mode with Motion or Sharpness selections.

4.4.6.2 Native Resolutions

The following live video resolutions are supported on the system:

Native NTSC:

- 4xSIF (704 x 480 pixels), *Digital Clarity*
- Interlaced SIF (352 x 480 pixels), *Natural Video*
- SIF (352 x 240 pixels)

Native PAL:

- 4xCIF (704 x 576 pixels), *Digital Clarity*
- Interlaced CIF (352 x 576 pixels), *Natural Video*
- CIF (352 x 288 pixels)
- QCIF (176 x 144 pixels)
- SQCIF (128 x 96 pixels)

Native PC Resolutions:

- XGA (1024 x 768 pixels), *Digital Clarity*
- SVGA (800 x 600 pixels), *Digital Clarity*
- VGA (640 x 480 pixels), *Digital Clarity*

4.4.7 Default Call Settings

Default Call Settings are connected with [Call Settings](#) in the call menu. If you leave Call Settings unchanged when making a call, the system will use the Default Call Settings in the call.

In addition to the Call Settings Call Type, Net, Bandwidth and Restrict (56k), you also find settings for H.320 Auto bandwidth and H.323 Auto bandwidth in Default Call Settings.

Call Type	<p>Call Type can be set to:</p> <ul style="list-style-type: none"> ▪ Video Call ▪ Telephone Call <p>If either the Call Type is set to Telephone Call or the Place Telephone Call icon is selected when making a call, the call will be set up as a telephone call. In all other cases the call will be set up as a video call.</p> <p>Some network configurations may cause the setup of a video call to fail. The call will then be set up as a telephone call instead if Fallback to Telephony is enabled.</p> <p>For MultiSite calls, Call Type enables you to specify both telephone calls and video calls in the same conference.</p>
Network	<p>The Network alternatives are:</p> <ul style="list-style-type: none"> ▪ Auto ▪ ISDN ▪ H.323 ▪ SIP <p>If Auto is selected, the system will select the right network depending on the entered number:</p> <ul style="list-style-type: none"> ▪ If an IP-address (e.g. 10.12.34.56) is entered, H.323 is selected. ▪ If the first digits in the number match those set in H.323 Prefix, H.323 is selected. ▪ In other cases, ISDN (H.320) is selected. <p>ISDN indicates:</p> <ul style="list-style-type: none"> ▪ ISDN-BRI <p>If a gatekeeper is present, it is possible to place IP-calls using “telephone-style” numbers, e.g. an E.164 alias, according to the numbering plan implemented in the gatekeeper. The gatekeeper will then translate the dialed number into an IP-address, see H.323 Settings for more information about gatekeepers.</p>

	<p>Select ISDN to ensure that the call is set up as an ISDN call.</p> <p>Select H.323 to ensure that the call is set up as an H.323 call.</p> <p>Select SIP to ensure that the call is set up as an SIP call.</p>
Bandwidth	<p>Bandwidth decides the quality of the video picture.</p> <p>When set to Auto the system will establish a connection using a proper bandwidth for the call, typically 384kbps for ISDN calls and 768kbps for IP calls.</p> <p>When set to Max the system will set up the call with maximum bandwidth depending on the selected network.</p> <p>Overview*</p> <p>Auto: 384 kbps on ISDN/768 kbps on LAN Max: 512 kbps on ISDN-BRI 2Mbps (1920 kbps, IP only)</p> <p>1472 kbps = 23B, IP only 1152 kbps = 18B, IP only 768 kbps = 12B, IP only 512 kbps = 8B 384 kbps = 6B 320 kbps = 5B 256 kbps = 4B 192 kbps = 3B 128 kbps = 2B, Bonding/H.221 64 kbps = 1B, H.221</p> <p>* Note that some software versions and networks do not support all channel selections.</p>
Restrict (56k)	<p>A restricted call uses 56kbps channels rather than the default unrestricted 64kbps channels.</p> <p>Some older networks (primarily in the USA) do not support 64kbps channels and require the use of restricted 56kbps calls. By default the system will dial an unrestricted call and downspeed to 56kbps if necessary.</p> <p>To force a restricted call, choose Restrict (56k) On.</p>

H.221 or 2x64 (2x56) Calling

Some older or low end video systems do not have the ability to make bonded ISDN calls. In these cases it is necessary to dial both ISDN numbers separately to call those systems.

These types of calls are often referred to as

- H.221 calls
- 2x64 calls
- 2x56 calls

- as making 2 x 64 kbps or 2 x 56 kbps calls to the same system.

Place this type of call by:

- Set Network to ISDN
- Set Bandwidth to 128 kbps
- A field for the 2nd number pops up in Call Settings.
- Enter the second number in the Call Settings field. For 128 kbps calls that use bonding, ignore the second number field and just enter one number to be dialed.

Using sub-address / extension address / MCU password

Sub-address is used to address different systems on the same ISDN line and is primarily used in European Countries. LAN equivalent extension address or TCS-4 is used to address different systems on a LAN, when dialing via a gateway.

To specify an ISDN sub-address or its LAN equivalent extension address (TCS-4), add a star (*) after the number and then enter the sub-address/extension address.

Example:

12345678*10 (<number>*<Sub-address/extension address/MCU password>)

When dialing IP via a gateway, the number behind the star (*) on IP might be interpreted as an extension address.

When calling to external MCU's requiring a password (TSC-1), this password can be added after the star (*). If no password is specified, the user will be asked to enter the password (after connecting to the MCU).

4.5 Audio

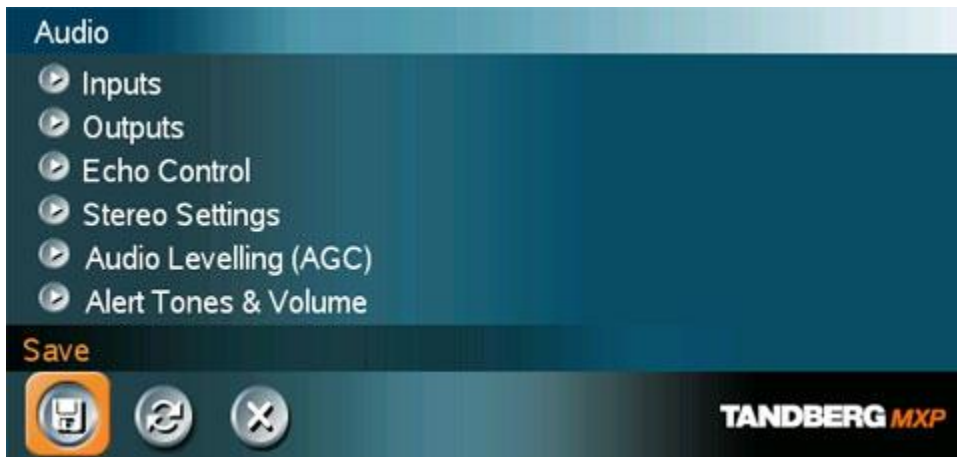

Audio contains the settings:

- [Inputs](#)
- [Outputs](#)
- [Echo Control](#)
- [Stereo Settings](#)
- [Audio Levelling \(AGC\)](#)
- [Alert Tones and Volume](#)

4.5.1 Inputs

Mic 1- 2 and Audio input 3-4

By default, all inputs are enabled. Just plug in an audio source and it is active. Audio inputs that are On will automatically be mixed. Unconnected inputs will automatically be muted. Select Off to prevent audio/noise from connected but unused inputs. The activated audio sources are stored on camera presets.

Mic 1 and 2 are intended for electret type microphones. The microphone inputs are balanced with 24V phantom power.

Audio inputs 3-4 (VCR Left/Right) are intended for connection to a VCR, DVD player or PC audio output. They can also be connected to other external playback devices. As there is no acoustic echo canceller on these inputs they should not be connected to any microphones. The audio entering these inputs will be heard from the local speaker as well.

Mix Mode

Auto	The adjustment of each microphone signal is done automatically to obtain the best possible audio and minimize the background noise.
Fixed	Fixed will maintain a constant weighting of all microphones.

VCR Ducking

If VCR Ducking is activated, the VCR audio level will be attenuated if someone talks into the microphone or at the far end.

The VCR ducking is only valid for audio input 4. If input 3 and 4 is configured to one stereo input pair, see [Stereo Settings](#), then the VCR ducking will apply to both input 3 and 4.

Level Settings

It is possible to adjust the audio input levels according to which external audio equipment is connected. The on-screen audio level indicator will make it easier to set the correct input level settings. The input level should be adjusted so that the average level reaches the preferred level marker. The audio inputs are adjustable in steps of 1.5 dB from 0 dB to 22.5 dB.

The default levels for Mic 1 and 2 are set for use with an Audio Technica AT871R or AT841R microphone in an average videoconferencing room. The gain can be adjusted correctly for a wide range of microphones.

A few examples of microphone levels are:

Audio Technica AT871R	+3dB (default)
Audio Technica AT851R	+7dB

TANDBERG Audio Science +19.5dB

Audio inputs VCR Left/Right are set to a default level which is adhered to by most manufacturers of audio-visual equipment and is a level at which most audio-visual equipment (CD-players, VCRs or DVDs) will work.

Please see [Interfaces](#) for details on the audio connectors.

4.5.2 Outputs

Audio Out

Audio out is internally connected to the monitor loudspeakers. The signal is a mix of audio from far end and local end Audio in (VCR Left/Right).

If an output is "Off", no audio will be sent to that output.

Level Settings

Adjust the audio output level to the loudspeakers.

The volume keys on the remote control also adjust the level of the audio output.

Please see [Interfaces](#) for details on the audio connectors.

4.5.3 Echo Control

Mic 1-2

Each of the 2 microphone inputs has a separate acoustic echo canceller. One echo canceller per input provides more sophisticated control than having one common canceller for all microphones. In addition to echo cancellation, the system has built-in noise reduction (NR). NR reduces constant background noise (e.g. noise from air-conditioning systems, cooling fans etc.). In addition, a high pass filter (Humfilter) reduces very low frequency noise.

On	Echo control is normally set to On to prevent the far end from hearing their own audio. Once selected, echo cancellation is active at all times. The echo canceller continuously adjusts itself to the audio characteristics of the room and compensates for any changes it detects in the audio environment. If the changes in the audio conditions are very significant the echo canceller may take a second or two to re-adjust.
Off	You can choose to switch off the echo canceller for the available audio sources. Echo Control should be switched Off if external echo cancellation or playback equipment is used.
On+NR	Activates both Echo Control and Noise Reduction.

Note that it is your echo canceller that improves the audio quality experienced by the other site. When you hear an echo of your own audio it is most likely the far end's echo canceller that is malfunctioning.

Tips for improving the echo canceller performance:

- It is recommended to place the microphone between 1 and 2 meters away from the persons speaking.
- Place the microphone as far as possible from noise sources.
- Reduce the volume setting. Ensure that the loudspeakers do not distort the audio.
- The echo canceller tries to estimate the echo path from the speaker system to the microphones. Moving objects change this path; therefore try to avoid moving objects. Be especially aware of large objects and objects placed close to either the microphone or the speaker system as these objects will cause severe changes to the echo path.
- Avoid putting paper sheets etc. on the microphone.
- Avoid moving the microphone or loudspeaker.
- In the presence of low frequency noise, enable the noise reduction (NR).

4.5.4 Stereo Settings

Stereo Input Mode (stereo audio)

If Stereo Input mode is on, Audio in 3 and 4 (VCR Left/Right) will behave as a stereo input pair. The VCR Ducking and AGC setting for VCR will in this case apply to both Audio in 3 and 4.

Audio out to the left loudspeaker will be a mix of Audio in 3 (VCR Left) the far end signal (left or mono), and Audio out to the right loudspeaker will be a mix of Audio in 4 (VCR Right) and the far end signal (right or mono).

If Stereo Input Mode is off, Audio out to both loudspeakers will be a mix of Audio in 3 and 4 and the far end (mono or left+right).

If the system is **connected to a Digital NAM**, stereo sound on the loudspeakers shall be present if a stereo input signal is connected to the inputs VCR-Left and VCR-Right or a stereo signal is received from the Far End.

If the system is **not connected to a Digital NAM**, stereo sound on the loudspeaker outputs will be present in the following situations:

- If system is idle and a stereo input signal is connected to the inputs VCR-Left and VCR-Right.
- If system is in a call with mic off and a stereo input signal is connected to the inputs VCR-Left and VCR-Right, or a stereo signal is received from the Far End.
- Otherwise the Loudspeaker Left signal will be equal to Loudspeaker Right.

4.5.5 Audio Levelling (AGC)

On	Select On to allow automatic adjustments (Automatic Gain Control) of audio levels. When On, the AGC maintains the audio signal level at a fixed value by attenuating strong signals and amplifying weak signals. Very weak signals, i.e. noise alone, will not be amplified.
Off	Audio levelling is not activated.

Note that to ensure correct behaviour of the AGC, it is crucial that the levels on the input connectors are adjusted correctly using the audio input level settings. The AGC will not compensate for severe maladjustment of input levels.

When applying a weak signal in the presence of strong background noise, the AGC might amplify the background noise as well as the signal. Therefore, in noisy environments, it is advisable to turn the AGC off.

Example:

In most conferences, the participants will speak at different levels, and be at different distances from the microphones. As a result, some of the participants would be harder to hear than others. The AGC corrects this problem by automatically increasing the microphone levels when “quiet” or “distant” people speak, and by decreasing the microphone levels when “louder” people speak.

4.5.6 Alert Tones and Volume

Video Call Alert Tone and Telephone Alert Tone

To help distinguish between incoming video calls and ordinary telephone calls, it is recommended to use different ringing tones for video calls and telephone calls.

Alert Volume

You may change the volume level for the selected ringing tone.

Alert Speaker

The system also has an internal, call-alerting speaker.

On	The internal speaker will warn you of an incoming call even though the monitor may not be switched on.
Off	The internal speaker is switched off.

Key Tones

On	There will be a sound indicator when pressing keys on the remote control.
Off	There will be no sound when pressing keys on the remote control.

4.6 Video

Video contains the settings:

- [Camera Tracking Mode](#)
- [MCU Status Line](#)
- [Floor to Full Screen](#)
- [Web Snapshots](#)
- [MultiSite Picture Mode](#)
- [Video Name](#)

4.6.1 Camera Tracking Mode

Slow	The system waits a while before zooming in on a single person speaking. Suitable when wide-angle images are preferred over close-up images.
Normal	Should be used in regular meetings.
Fast	The system quickly zooms in on a single person speaking. Suitable when close-ups are preferred over wide-angle images.

Note that the Camera Tracking Mode entry will not be available if not using the TANDBERG WAVE II Camera.

4.6.2 MCU Status Line

On	The MultiSite / MCU / DuoVideo indicators will be displayed and provide information about the conference.
Off	The MultiSite / MCU / DuoVideo indicators will not be displayed.
Auto	The MultiSite / MCU / DuoVideo indicators will be displayed for a few seconds and then timed out. When grabbing the remote control, the indicators will be shown again.

4.6.3 Floor to Full Screen

When "Floor to Full Screen" is enabled, someone who requests floor will be seen by all participants as full screen. When "Floor to Full Screen" is "Off", someone who request floor in a MultiSite conference using the 5+1 layout will be seen in the large square, rather than full screen.

On	The participant that has floor is displayed in full screen regardless of what MultiSite layout that is used.
Off	The participant that has floor is displayed in the MultiSite layout that is used.

4.6.4 Web Snapshots

The system is able to generate JPEG snapshots and provide them to the world outside by request (as 'http get' or via ftp). See [Appendix 6](#) for descriptions of the possible snapshot files.

On	Snapshots generation is enabled.
Off	Snapshots generation is disabled.

Note that web snapshots are not generated if the conference is encrypted.

4.6.5 MultiSite Picture Mode

MultiSite* Picture Mode decides the default layout of a MultiSite call. Choose between the layouts: Auto Split, 4 Split, 5+1 Split, and Voice Switched. You can change the layout during a call using the layout option in MultiSite Services.

Auto Split	Auto Split displays all participants on the screen simultaneously. A MultiSite call with 3 or 4 video participants is displayed with 4 Split. A MultiSite call with 5 or 6 video participants is displayed with 5+1 Split.
Voice Switched	Voice Switched mode displays the participant that is speaking in full screen.
4 Split	4 Split displays the 4 last speaking Participants.
5+1 Split	5+1 Split displays the speaking participant in a big picture and the other participants in small pictures.



Continuous Presence layout 4 split



Advanced Continuous Presence Layout (5+1)

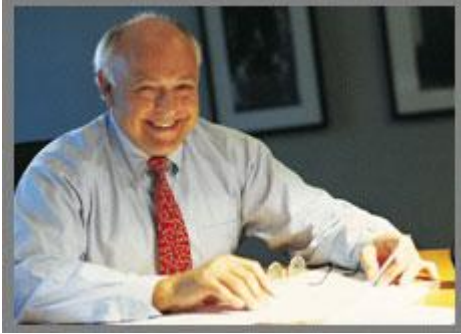

Voice Switched mode

4.6.6 Video Name

As a default, the video inputs are given the names Main Cam, PC, Doc Cam, VCR, AUX or VNC, dependent on what video sources are available on your system. The video names cannot exceed eight characters. The names correspond to the video names in the Presentation Menu (Choose Presentation from the main menu and open the Main Video or Presentation Video pop up menu). If video names are changed, you will see the changed name appear in the Main Video and Presentation Video menus.

4.7 Security



The screenshot shows the 'Security' configuration screen. It features a dark blue background with white text. The settings are as follows:

- Encryption:** Radio buttons for Off, On, and Auto. 'Auto' is selected.
- Encryption Mode:** Radio buttons for AES, DES, and Auto. 'Auto' is selected.
- Administrator Password:** An empty text input field.
- IP Access Password:** A text input field containing several asterisks.
- Streaming Password:** A text input field containing several asterisks.
- VNC Password:** A text input field containing several asterisks.
- Remote Upgrade Password:** A text input field containing several asterisks.
- Access Code:** Radio buttons for Off and On. 'Off' is selected.

At the bottom of the screen, there is a 'Save' button with a floppy disk icon, a refresh button with a circular arrow icon, and a close button with an 'X' icon. The 'TANDBERG MXP' logo is visible in the bottom right corner.

Security contains the settings:

- [Encryption](#)
- [Encryption Mode](#)
- [Passwords](#)

4.7.1 Encryption

(Country specific)

Auto	<p>The system will try to set up calls using encryption.</p> <p>Point to point calls: If the far end system supports encryption (AES or DES), the call will be encrypted. If not, the call will proceed without encryption.</p> <p>MultiSite calls*: In order to have encrypted MultiSite calls, all sites must support encryption. The padlock symbol will indicate encryption mode (AES or DES). If there is a mix of AES and DES encryption, only the symbol for DES encryption (single padlock) will be displayed. The 'closed padlock' will only be displayed on each site when all links in the MultiSite conference are encrypted.</p> <p>If the far end supports encryption, the systems will initiate encryption after the call is connected (an 'open padlock' symbol will be displayed). When encryption has been established, a 'closed padlock' symbol will be displayed.</p>
On	<p>The system will only send and receive encrypted data. The call will not be established if not all participants support encryption.</p>
Off	<p>The system will not send or receive encrypted data.</p>

Technical encryption information like encryption algorithm and encryption check code can be found in the Call Status menu.

* Only available on systems with MultiSite option supported and installed.

4.7.2 Encryption Mode

Auto	The system will try to use the most secure encryption - AES, dependent on the capabilities of the other sites. For sites that do not support AES encryption, DES encryption will be tried.
AES	The system will try to use AES with 128 bits encryption when setting up calls. If AES is not supported by the other site(s), no other type of encryption will be initiated.
DES	The system will always try to set up the call using DES with 56 bits encryption on ISDN and IP. If all other sites do not support DES, no other type of encryption will be initiated.

Both AES and DES Encryption are supported for mixed ISDN/IP calls. In addition AES -and DES Encrypted sites can be connected at the same time.

4.7.3 Passwords

Administrator Password, IP Access Password, Streaming Password, VNC Password, Access Code and Remote Software Upgrade password are duplicated from their respective menus. Using the Security menu gives you a quick way to change all passwords of the system.

4.8 Network

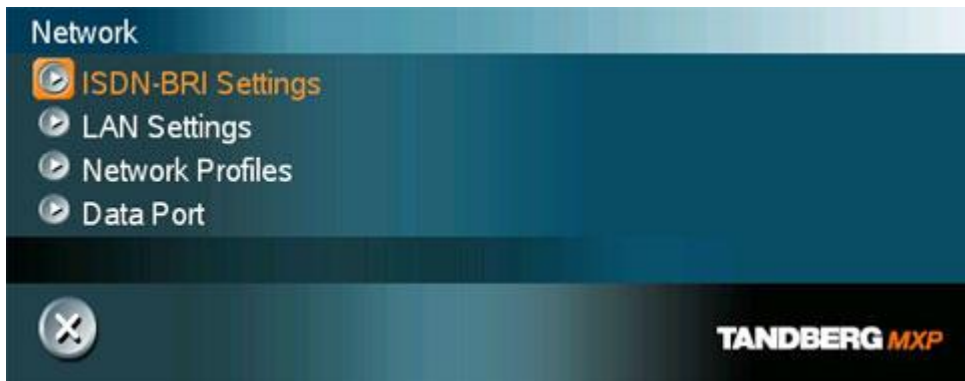

The network menu contain:

- [ISDN-BRI Settings](#)
- [LAN Settings](#)
- [Network Profiles](#)
- [Data Port](#)

4.8.1 ISDN-BRI Settings

To make sure your system will work properly using ISDN-BRI, make the following settings:

1. Set ISDN switch type
2. Enter ISDN line numbers (+ SPIDs if required)
3. Disable unused lines

Some software versions do not support 6 ISDN lines, therefore some of the Line Setup entries may be grayed out.

ISDN switch type

Select the type of ISDN network connected to your unit. Note that 1TR6 should only be used if you are operating the system behind a PABX.

Line setup

This menu allows you to program the numbers associated with your ISDN line. If you want to use this ISDN line, you need to set Enabled On and enter the numbers of your ISDN line. If some of the ISDN lines are not to be used, set Enabled Off. Line 1 should always be enabled. National ISDN and AT&T Custom ISDN might require SPID numbers associated with your ISDN numbers. If you have received two different SPID (Service Profile Identifier) numbers for each ISDN line from your network provider, you must program both.

<i>Example*:</i>		
	Numbers	SPIDS
ISDN BRI 1:	67838498 67838498	016783849800 016783849810
ISDN BRI 2:	23478060 23478070	012347806000 012347807000
ISDN BRI 3:	23478420 23478430	012347842000 012347843000
ISDN BRI 4:	23478520 23478530	012347852000 012347853000

* Note that some systems has less than 4 BRIs available.

Advanced ISDN Settings

Sub address

Using a sub address enables you to connect up to eight ISDN terminals to the same ISDN telephone number and line. The terminals are addressed by using different sub addresses. To

call a terminal with a sub address, separate the ISDN telephone number and the sub address with a '*'. Note that this service has limited access on some ISDN networks.

Example: 12345678*2 (up to four digit sub addresses are possible).

Validate Numbers / MSN (Multiple Subscriber Number)

The use of MSN (Multiple Subscriber Number) enables you to attach different ISDN terminals, with different numbers, to the same physical ISDN telephone line. If Validate Numbers is set to On only calls to those numbers specified in the Line Setup menus will be answered. This service can be ordered from your telephone company.

Parallel dial

On	Channels will be dialed and connected in parallel when setting up a BONDING call.
-----------	---

Off	Channels will be dialed one by one, which may increase the dialing time.
------------	--

Send Own Numbers

On	The system will send its own numbers to the far end.
-----------	--

Off	The system will not send its own numbers to the far end, but please note that the network may still send your numbers to the far end.
------------	---

Sending Complete

On	The system will send the ISDN message information element Sending Complete.
-----------	---

Off	The system will not send Sending Complete.
------------	--

4.8.2 LAN Settings

LAN Settings contain:

- [IP Settings](#)
- [H.323 Settings](#)
- [SIP Settings](#)
- [Wireless LAN Settings](#)
- [SNMP Settings](#)
- [IP Services](#)
- [Quality of Service](#)

4.8.2.1 IP Settings

Remember to restart the system after making changes to IP Settings. This can be done by selecting the “Save and Restart” at the bottom of the IP setting menu. Changes in IP Settings menu will not have any effect before the system is restarted.

IP-assignment

DHCP (Dynamic Host Configuration Protocol) can be selected when a DHCP server is present.

DHCP	IP-address, IP-subnet mask and Gateway are not used because the DHCP server assigns these parameters.
Static	The system’s IP-address, IP-subnet mask and Gateway must be specified in the IP-address field.

IP-address

IP-address defines the network address of the codec. This address is only used in static mode. In DHCP-mode, the assigned IP-address can be found on the Welcome Menu.

IP-subnet mask

IP-subnet mask defines the type of network. This address is only used in static mode. Your LAN-administrator will provide the correct value for this field.

Gateway

When using DHCP, the default gateway will be set automatically. If the LAN utilizes static IP addresses, IP address, subnet mask, and default gateway must be specified by the LAN administrator.

Ethernet Speed

Auto	The codec will auto-detect the speed/duplex on the LAN.
10/Half	The codec will connect to the LAN using 10Mbps speed/Half Duplex.
10/Full	10 Mbps speed/Full Duplex.
100/Half	100 Mbps speed/Half Duplex.
100/Full	100 Mbps speed/Full Duplex.

IP Access Password

By setting an IP Access Password on the system, all access to the system using IP (Telnet, FTP and WEB) requires a password. The default IP Access Password is "TANDBERG".

- [DNS Settings](#)

DNS Settings

DNS Server 1-5

DNS Server defines the network addresses for DNS servers. Up to 5 addresses may be specified. If the network addresses are unknown, please contact your administrator or Internet Service Provider.

DNS Domain Name

DNS Domain Name is the default domain name suffix which is added to unqualified names.

Example:

DNS Domain Name is “example.com”, and the name to lookup is “videosystem” will result in a “videosystem.example.com” DNS lookup.

4.8.2.2 H.323 Settings

H.323 Settings

E.164 alias

This is the E.164 address of the system. The E.164 address is equivalent to a telephone number, sometimes combined with access codes. Valid characters are 0-9,* and #. When using a gatekeeper, the system will send a message to the gatekeeper containing both the E.164 address and the H.323 ID of the system.

H.323 ID

The H.323 ID of the system may be specified here. The System name is used if no H.323 ID is entered.

H.323 Call Setup

Direct	An IP-address must be used in order to make a H.323 call. The system will not use a gatekeeper or CallManager
Gatekeeper	The system will use a gatekeeper to make a H.323 call.
CallManager	The system will use a CallManager to make a H.323 call.

H.323 Prefix

When dialing a number prefixed with digits specified by H.323 Prefix, and with Net: Auto, an H.323 call will be placed.

Example:

H.323 Prefix is "555". Dialing "55582" with "Net:Auto" will select LAN.

- [Gatekeeper Settings](#)
- [CallManager Settings](#)
- [Advanced H.323 Settings](#)

Gatekeeper Settings

Gatekeeper Discovery

Auto	The system will automatically try to register on any available gatekeeper. If a gatekeeper responds to the request sent from the codec within 30 seconds this specific gatekeeper will be used. This requires auto discovery on the gatekeeper as well. If no gatekeeper responds, the system will not use a gatekeeper for making H.323 calls and hence an IP-address must be specified manually.
Manual	The system will use a specific gatekeeper identified by Gatekeeper IP-address.

Gatekeeper IP Address

This is the gatekeeper IP-address that is used if you specify H.323 Call Setup: Gatekeeper and Gatekeeper Discovery: Manual.

Note that if your system is part of a TANDBERG Expressway™ firewall traversal solution and is placed outside the firewall, you should register the IP address of your Border Controller as the Gatekeeper IP address and set H.323 Call Setup to Gatekeeper.

Authentication Mode

Auto	If Authentication Mode is set to Auto and the gatekeeper indicates that it requires authentication, the endpoint will automatically try to authenticate itself to the Gatekeeper.
Off	If Authentication Mode is set to Off the system will not try to authenticate itself to a Gatekeeper, but will still try a normal registration.

Authentication ID / Authentication Password

The system sends the Authentication ID and Password to a Gatekeeper for authentication. The authentication is a one way authentication from the endpoint system to a Gatekeeper, i.e. the endpoint is authenticated to the Gatekeeper. If the Gatekeeper indicates that no authentication is required, the endpoint will still try to register.

CallManager Settings

CallManager IP

This is the CallManager IP-address that is used if you specify H.323 Call Setup: CallManager.

Advanced H.323 Settings

The Advanced H.323 Settings only have an effect if they are supported by your IP infrastructure.

NAT

NAT, Network Address Translation, is used when a PC and a videoconferencing system are connected to a router with NAT support. NAT support in the videoconferencing system enables proper exchange of audio/video data when connected to an external videoconferencing system (when the IP traffic goes through an NAT router). When NAT is On, the NAT Server Address will be shown in the startup-menu: "My IP Address: 10.0.2.1".

On	The system will signal the configured "NAT Address" in place of its own IP-address within Q.931 and H.245.
Auto	The system will try to determine if the "NAT Address" or the real IP-address should be used within signalling. This is done to make it possible to place calls to endpoints on the LAN as well as endpoints on the WAN.

NAT Address

This must be the external/global IP-address to the router with NAT support. Packets sent to the router will then be routed to the system. In the router, the following ports must be routed to the system's IP-address:

Port 1720
 Port 5555-5560
 Port 2326-2365

Please contact your TANDBERG representative for further information.

RSVP

Auto	Resource Reservation Protocol enables the systems to request the optimal amount of bandwidth for the duration of an IP videoconference.
Off	Resource Reservation Protocol is switched off.

H.323 Ports

Static	When selecting static H.323 ports for TCP connections the ports 5555 to 5565 will be used for Q.931 and H.245 respectively.
Dynamic	The system will allocate which ports to use when opening a TCP connection. The reason for doing this is to avoid using the same ports for subsequent calls as some firewall consider this as a sign of attack.

4.8.2.3 SIP Settings

Mode

On	Setting the SIP mode to on will enable the system for incoming and outgoing SIP calls.
Off	Setting the SIP mode to off will disable incoming and outgoing SIP calls from the system.

Display Name

The Display name part of the SIP Address (URI) is usually a full name or system name.

Examples:

“Alice Wonderland”
“System 01”

SIP Address

The SIP Address is the SIP URI used to address the system.

SIP Address (URI): <text field>

Examples:

“alice@example.com”
“1234”
“1234@example.com”

Server Discovery

Auto	When Auto is selected, the SIP Server address is obtained using Dynamic Host Configuration Protocol (DHCP).
Manual	When Manual is selected, the manually configured SIP Server address will be used.

Server Address

The Server Address is the manually configured address for the outbound proxy and registrar. It is possible to use a fully qualified domain name, or an IP address. The default port is 5060 for TCP and UDP, but another one can be provided.

Server Address: <text field>

Examples:

“sipserver.example.com”

“sipserver.example.com:5060”

“10.0.0.2”

“10.0.0.2:5061”

Authentication**User Name**

This is the user name part of the credentials used to authenticate toward the SIP Server.

User name: <text field>

Password

This is the password part of the credentials used to authenticate toward the SIP Server.

Password: <text field>

4.8.2.4 Wireless LAN Settings

SSID (Service Set Identification)

Example "WLANNETWORK". Defines a local network id for this wireless region. It must be the same for all end points and the access point. An endpoint will find the access point if the SSID is correct, however if the encryption key is faulty it will not transmit any data.

Community (optional)

Community can be used when connecting to an access point where the SSID is the same. Example "Unit2".

WLAN Mode

AdHoc	Used when not communicating with an access point.
Managed	Used when communication is made through an access point.

Make sure the corresponding settings are programmed into the access point. Press "Restart" from Control Panel in order to activate the settings.

Required cards

- Compaq WL110 11 Mbps Wireless LAN
- Lucent Orinoco 11 Mbit/s SILVER
- Lucent Orinoco 11 Mbit/s GOLD
- Cisco Aironet 350 series (AIR-PCM 350 series)
- Enterasys Networks RoamAbout 802.11 DS High Rate
- Melco Buffalo WLI-PCM-L11G

Recommended access point

- Compaq WL410 base station

Note! The PC card/PCMCIA-card used must comply with the relevant regulations for such cards in the country where it is used. The unit must be supplied by power supply (AC-DC adapter) powerbox SPN-270-12, which complies with the requirements for limited power source according to IEC/EN 60950.

Encryption

Select Encryption if you want to use WEP encryption on your Wireless LAN connection. Increased encryption level will decrease performance.

Use Key:	Select which of the keys shown below you want to use.
-----------------	---

Key 1-4 The 64-bit keys can consist of a leading star (*) and 5 characters.
The 128-bit key can consist of a leading star (*) and 13 characters.
Start with a * and then the text. Example: 128 bit key: *secretkeyhome.

Encryption using Hex numbers The 64-bit keys can consist of 10 hexadecimal digits. Example: "de01ad4dbe". The 128-bit key can consist of 26 hex numbers.

4.8.2.5 SNMP Settings

SNMP Settings

SNMP Trap Host identifies the IP-address of the SNMP manager. SNMP (Simple Network Management Protocol, SNMP Ver 1) is used for monitoring and configuring of different entities in a network. The system's SNMP Agent responds to requests from SNMP Managers (a PC program etc.). SNMP traps are generated by the agent to inform the manager about important events.

Traps can be sent to multiple SNMP Trap Hosts. Enter the IP address of up to three SNMP managers. All traps will then be sent to the hosts listed.

SNMP Community names are used to authenticate SNMP requests. SNMP requests must have a 'password' in order to receive a response from the SNMP agent in the codec. Note that the SNMP Community name is case sensitive. The default password is "public".

4.8.2.6 IP Services

NTP IP

This is the NTP time server address from which the system can get updated time information.

The Network Time Protocol (NTP) is used to synchronize the time of the system to a reference time server. The NTP IP setting holds the IP address to a time source where the system can get the exact time. The time server will subsequently be queried every 24th hour for time updates. The system will use the time to timestamp messages transmitted to Gatekeepers or Border Controllers requiring H.235 authentication.

4.8.2.7 Quality of Service

QoS Type

Off	No QoS is used.
Diffserv	Diffserv QoS method is used. Please see below for details.
IP Precedence	IP Precedence QoS method is used. Please see below for details.

IP Precedence Video

Used to define which priority audio, video, data and signaling should have in the network. The higher the number, the higher the priority. The priority ranges from 0(off) - 7 for each type of packets.

Auto will provide the following priority:

Audio	4
Video	4
Data	3
Signaling	6

IP Type of Service (TOS) helps a router select a routing path when multiple paths are available.

Delay	Tells the router to minimize the delay.
Throughput	Tells the router to maximize the throughput.
Reliability	Tells the router to maximize the reliability.
Cost	Tells the router to minimize the cost.

IP Precedence Telephony

Used to define which priority audio should have in the network for telephone calls. The higher the number, the higher the priority. The priority ranges from 0(off) - 7 for each type of packets.

Auto will provide the following priority:

Audio	4
-------	---

Diffserv Video

Used to define which priority Audio, Video, Data and Signaling packets should have in an IP network. The priority ranges from 0 to 63 for each type of packets.

Diffserv Telephony

Used to define which priority Audio packets should have in an IP network for telephone calls. The priority ranges from 0 to 63 for each type of packets.

4.8.3 Network Profiles

This menu consists of 7 network profiles; a prefix can be added for each profile. If you add a prefix to a profile, this prefix will automatically be added in front of the number being dialed.

Example:

0 is added as a Call Prefix to the 2nd profile, ISDN. If you enter 12345678 in the dial menu and select ISDN, the number dialed will be 012345678.

Using the three last profiles you can enter the name of a profile, prefix and network selection. This is useful if you have a fixed prefix for your service provider.

4.8.4 Data Port

The system provides up to two standard RS232 serial ports to allow a computer to be connected for data transfer and control purposes. Note that when connecting to a PC the connecting cable must be a straight through RS232 cable.

Baud Rate, Parity, Databits and Stopbits

If you wish to connect a PC to Data port 1, you must ensure that the PC and the system are identically configured. The available settings are:

Baud Rate	1200, 2400, 4800, 9600, 19200, 38400, 57600, 115200
Parity	None, Odd, Even
Databits	7, 8
Stopbits	1, 2

The control interface provided by the data port supports a subset of the Hayes command set as well as a comprehensive set of system specific commands. It maintains communication with the data port's command interpreter at all times. All features available from the hand-held remote control can be accessed through the data port.

4.9 Restore Default Settings

Restore Default Settings will restore all administrator settings. Note that this will not affect your Call Directory information, Network Type, Line Setup numbers or your SPID numbers.

5 Peripheral Equipment

Using the optional peripheral devices outlined in this chapter and the many others available, you will be able to build your own applications for use with the system, thereby better integrating the system into your business environment. This chapter will explain how to connect peripheral equipment to your system. First of all however, we recommend you examine [Interfaces](#), with details on the available connectors on the back of the system Codec.

Peripheral Equipment contains:

- [Interfaces](#)
- [Document Camera](#)
- [VCR / DVD](#)
- [Additional Cameras](#)
- [Additional Microphones](#)
- [TANDBERG DNAM](#)
- [Stereo Speaker Kit](#)
- [Telephone Add-On](#)
- [Dual Monitor](#)
- [XGA Monitors and Projectors](#)
- [VESA Display Power Management](#)
- [Digital Monitor Power Management](#)
- [Extended Display Identification](#)

5.1 Interfaces

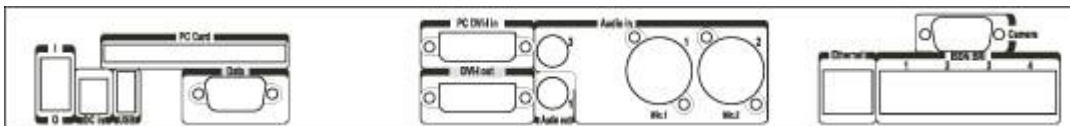

This drawing shows only the active connectors. Some products may have additional non-working connectors

5.1.1 Video

2 Video Inputs

- 1 video input used by the camera.
- 1 video input supporting S-Video through a Mini-DIN connector.
- 1 VGA/DVI-I (DVI = Digital Video Interface, I = Integrated Digital & Analog) input supporting resolutions SVGA (800x600), XGA (1024x768) and SXGA (1280x1024), analog or digital.

VGA formats supported on 'DVI-I in':
SVGA (800x600) 60Hz, 72Hz, 75Hz, 85Hz
XGA (1024x768) 60 Hz, 70Hz, 75Hz
SXGA (1280x1024) 60Hz
HD720p (1280x720) 50,60 Hz

1 Video Outputs

- 1 VGA/DVI-I (DVI = Digital Video Interface, I = Integrated Digital & Analog) output supporting resolutions SVGA (800x600) and XGA (1024x768), analog or digital.

VGA formats supported on 'DVI-I out':
SVGA (800x600) 75Hz
XGA (1024x768) 60Hz
WXGA (1280x768) 60Hz
HD720p (1280x720) 50,60 Hz

DVI and specifications:

DVI stands for Digital Video Interface, and is a form of video interface technology made to maximize the quality of flat panel LCD monitors and high-end video graphics cards.

The TANDBERG codec contains a DVI-I plug that can transmit either digital DVI signals or standard analog VGA signals, depending on what type of monitor is connected.

DVI Specifications

TANDBERG DVI-I follows the VESA Monitor Timing Standard v1.08, also known as Display Monitor Timing (DMT).

Analog	Horizontal Frequency	Vertical frequency	Pixel Clock
800x600 @ 75Hz	46.875kHz	75.00Hz	49.50MHz
1024x768 @ 60Hz	48.363kHz	60.004Hz	65.00MHz
Digital			
800x600 @ 75Hz	46.875kHz	75.00Hz	49.50MHz
1024x768 @ 60Hz	48.363kHz	60.004Hz	65.00MHz

DVI-I Video resolution supported in F1 and above

Supported DVI cables:

TANDBERG supports DVI-D Single-Link, DVI-A and DVI-I Single-Link format cables.

DVI-D cables transmit digital T.M.D.S. signals, DVI-A cables transmit analog VGA signals and DVI-I cables can transmit either digital or analog signals.

It is possible to extend existing DVI cables by the use of extension cables. The maximum cable length however, is 5 meters. Going beyond that may result in quality loss.

DVI-I - Combined Analog and Digital Connector Pin Assignments:

Pin	Signal Assignment	Pin	Signal Assignment	Pin	Signal Assignment
1	T.M.D.S. Data2-	9	T.M.D.S. Data1-	17	T.M.D.S. Data0-
2	T.M.D.S. Data2+	10	T.M.D.S. Data1+	18	T.M.D.S. Data0+
3	T.M.D.S. Data2/4 Shield	11	T.M.D.S. Data1/3 Shield	19	T.M.D.S. Data0/5 Shield
4	T.M.D.S. Data4-	12	T.M.D.S. Data3-	20	T.M.D.S. Data5-
5	T.M.D.S. Data4+	13	T.M.D.S. Data3+	21	T.M.D.S. Data5+
6	DDC Clock	14	+5V Power	22	T.M.D.S. Clock Shield
7	DDC Data	15	Ground (return for +5V, HSync and VSync)	23	T.M.D.S. Clock+
8	Analog Vertical Sync	16	Hot Plug Detect	24	T.M.D.S. Clock-

C1	Analog Red	C2	Analog Green	C3	Analog Blue
C4	Analog Horizontal Sync	C5	Analog Ground (analog, R, G & B return)		

5.1.2 Audio

4 Audio Inputs

- 2 microphone inputs (balanced, 24V phantom powered) via XLR connectors.
- 2 audio inputs (line level) via RCA connectors.

All audio inputs are active by default. For further information, refer to chapter [Audio](#).

Audio input connector specification:

Connector label	Microphone(s)	Audio input(s)
Signal type	Balanced	Unbalanced
Connector (codec)	XLR-F, pin 1-gnd, pin 2 hot, pin 3-cold/neutral	Female RCA/phono, sleeve-ground, centre-signal
Input impedance	2400 ohms (pin 2 - 3)	10K ohms
Max input level when set to maximum input level	83 mVpp	15.5 Vpp
Max input level when set to minimum input level	6.2 mVpp	1.17 Vpp
Range, menu adjustable input gain	22.5 dB (16 steps of 1.5 dB)	22.5 dB (16 steps of 1.5 dB)
Phantom power voltage	24 V +/- 5%	-
Phantom power resistor, pin 2	1200 ohms	-
Phantom power resistor, pin 3	1200 ohms	-
Max phantom power current pr mic	12 mA	-

2 Audio Outputs

- 2 outputs (line level) via RCA connector providing audio from far end in addition to dial tones. These outputs are used by the monitor loudspeakers.

Audio output connector specification:

Connector label	Audio outputs
Signal type	Unbalanced
Connector (codec)	Female RCA/phono, sleeve-ground, centre-signal
Output impedance	680 ohms
Max output level when set to maximum output level	
PAL	0.75 Vpp
NTSC	1.75 Vpp
Max output level when set to minimum output level	
PAL	0.75 Vpp
NTSC	1.15 Vpp
Range, menu adjustable output gain	22.5 dB (16 steps of 1.5 dB)
Volume control attenuation (audio out 1)	0 to 21 dB + mute (steps of 1.5 dB)

5.1.3 Network

Ethernet:

1 x Ethernet (RJ-45 Jack) LAN interface (10/100 Mb) up to 2 Mbps or 2.3 Mbps depending on the bandwidth option installed.

To connect the system to a LAN, use the Ethernet cable provided by TANDBERG (or a standard Ethernet cable).

The cable specification is:

```

1 ----- 1
2 ----- 2
3 ----- 3
6 ----- 6

```

If no LAN is available and the codec is connected directly to a computer, use a crossover cable.

The crossover cable specification is:



If such a connection is needed, the system and the PC must use 'static' TCP/IP settings because no DHCP server is controlling the small "LAN", which has been created between the computer and the system. When configuring a back-to-back connection between the PC and the system, make sure both static IP addresses exist on the same subnet.

ISDN BRI Interface:

ISDN I.420 (RJ-45 Jack) Basic Rate Interface S/T (2B+D), 128 kbps per ISDN I/F

To connect the system to BRI, use the ISDN cable provided by TANDBERG (or a standard BRI cable).

The pinout of the S/T interface is:

BRI	Pinout
Pin-3	TX+
Pin-4	RX+
Pin-5	RX-
Pin-6	TX-

5.1.4 Data port

The data port(s) are implemented as Digital Circuit Terminating Equipment (DCE). The connector used are female 9-pin D-sub.

Signal name	Direction	Pin number
Carrier detect, CD	From DCE	1
Receive data, RXD	From DCE	2
Transmit data, TXD	To DCE	3
Data terminal ready, DTR	From DCE	4
Signal ground, GND		5
Data set ready, DSR	From DCE	6
Ready to send, RTS	To DCE	7
Clear to send, CTS	From DCE	8
Ring indicator, RI	From DCE	9

5.2 Document Camera

A document camera can be used for showing text, diagrams and a variety of graphical material as well as small three-dimensional objects.

How to use a document camera with your system:

1. Connect the document camera to the Doc Cam input, if available, on the system.
2. Open the Presentation menu from Main menu and choose Doc Cam.
3. You can also program the Presentation key on the remote to activate document camera. See chapter [Presentation Key](#) for more information.

If you want to use S-Video from the document camera, you can connect the document camera to the AUX input on the system.



Note that this requires a system with an additional video input.

5.3 DVD / VCR

DVD/VCR Playback

Mono

For playback, connect a cable between Video Out on the VCR and Video In (VCR) on the system. Connect a cable between Audio Out on the VCR and the Audio In (VCR) on the system. Choose VCR from the Presentation menu to activate the VCR input.

Make sure that Audio In (VCR) is On (see chapter [Audio](#)). If audio from VCR is too low, this level can be adjusted in Audio Settings, Inputs, Level Settings. The audio from the VCR will be audible in the local speaker system.

The audio from the VCR and your microphone(s) will be mixed and sent to the far end. When a person talks on either local or far end, the VCR audio level will be reduced to make it easier to comment on a video recording when Audio Settings, VCR Ducking: On.

Stereo

For stereo playback, connect:

- Video cable between Video Out on the VCR and Video In (VCR) on the system
- Audio cable between Audio Out (L) on the VCR/DVD and the VCR L (Audio In 3)
- Audio cable between Audio Out (R) on the VCR/DVD and VCR R (Audio In 4)
- Choose the VCR video source (see chapter [Presentation menu](#)) to automatically activate the VCR audio and video input.

Make sure that:

- Stereo Input Mode is set to On (see chapter [Stereo Settings](#))
- 128 AAC-LD is enabled (see chapter [AAC-LD 128 kbps](#))
- AAC-LD is enabled (see chapter [Audio Algorithm](#))
- Audio In (VCR) is On (see chapter [Audio](#)). If audio from VCR is too low, this level can be adjusted in Audio Settings, Inputs, Level Settings. The audio from the VCR will be audible in the local speaker system.
- To enable VCR/DVD ducking (reduce volume when speaking), check that VCR Ducking under Audio Settings is set to On.

Note that the audio from the VCR/DVD and your microphone(s) will be mixed and sent to the far end. When a person talks on either local or far end, the VCR/DVD audio level will automatically be reduced to make it easier to comment on a video recording when Audio Settings, VCR Ducking: On.

Note that a system with one video output and one mixed (local and far end) audio output is required for recording. For playback, a system with one video input and one audio input without integrated echo cancellation is required.

5.4 Additional Cameras

Extra fixed Cameras

You can connect extra fixed cameras to your system, for example, a whiteboard camera. Connect the video output of the additional camera to one of the available Video inputs on the system.

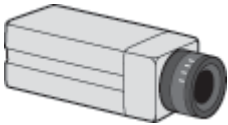

Note that additional controllable cameras are only available for rollabout systems. Settops and personal systems may be able to connect additional cameras.

5.5 Additional Microphones

If your environment is such that you require more than one microphone for your room, e.g. you have a whiteboard at a distance from your table microphone, it is possible to connect additional microphones to your system. See [Appendix 4](#) for more information.

Note that this requires a system with more than one XLR input.

You can connect two microphones to your system. The connectors are marked Mic1, Mic2. The connected microphones will by default be mixed.

When more than one microphone is connected, you have the option to use the Voice Activate Camera Tracking feature.

5.6 The TANDBERG DNAM

The TANDBERG Digital Natural Audio Module*:

- Audio In: S/PDIF or Analog
- Differential In: Differential Mono input (Analog).
 - Pinout: 1 GND, 2 and 3 signal
- Loop out: Will always give a mono analog output of the input. Even with S/PDIF in, this output will give an analog mono output.
- 5 x 40W continuous average output power, to the load specified by DNAM speakers.
- Fuse 2A 250V Slow, 5 x 20mm, Littelfuse type 215002.

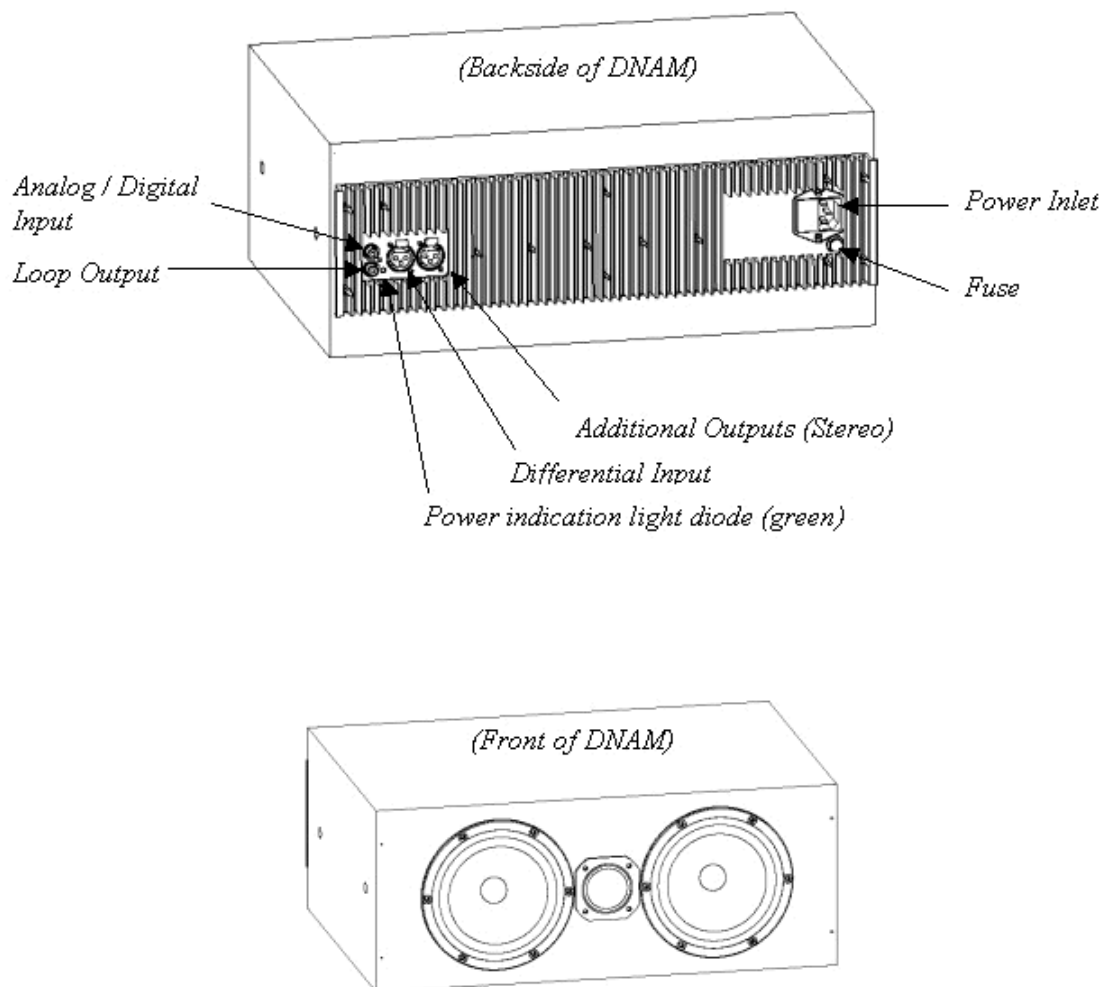

Stereo out:

DNAM Stereo Output Cable (non terminated)

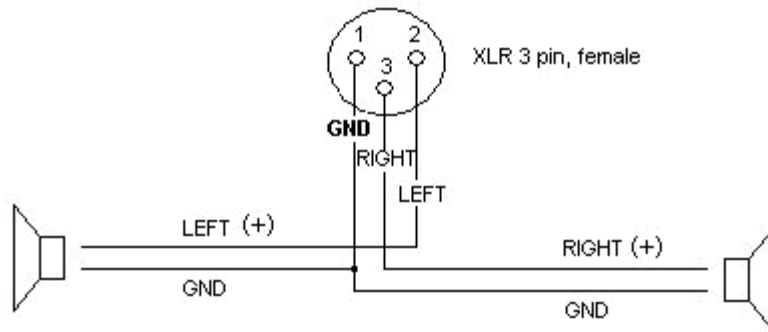

*The TANDBERG Digital Natural Audio Module is integrated in some TANDBERG systems. Please contact your TANDBERG representative for more information.

5.7 Stereo Speaker Kit

Note that the following applies only for systems with a stereo S/PDIF output.

The Stereo Speaker Kit provides a pair of floor-standing loudspeakers in addition to the built-in [DNAM](#). Using these speakers will enable stereo functionality in your system and thereby enhance the sound experience.

To experience stereo sound, the stereo speakers have to be connected to the Digital Natural Audio Module (DNAM) as well as confirming this under Stereo Settings in the main audio menu. The stereo sound source may either be located at the far end, or locally as a sound source (CD, DVD) connected to the codec audio AUX/VCR inputs. If using a local stereo sound source, you also have to enable Stereo I/O mode (On) in the same audio menu, to be able to receive stereo sound on your system, and to send stereo signals to the far end. See chapter 4.5.4 for more information.

Check also that the full-range frequency audio coding AAC-LD is enabled (In Call Quality menu, AAC-LD is checked, and AAC-LD 128 threshold is the same or lower than the call rate you are planning to use). See chapter [Audio Algorithm](#) and [AAC-LD 128kbps](#) for more information.

An installation sheet is enclosed in the Stereo Loudspeaker Kit, which also describes recommended physical speaker placement.

Note that if stereo speakers are enabled in the menu without having any stereo speakers connected to the Digital NAM, or having other speakers than the TANDBERG stereo speakers, it may cause the acoustic echo-canceller to malfunction.

5.8 Telephone Add-On

The system has a built in audio bridge* that can bring in Voice over IP (VoIP) telephony or normal telephone sites using ISDN.

Note that this requires a system with mixed audio output (audio from local and far end) and one audio input without integrated echo cancelling.

In addition to using ISDN and IP for your telephone sites, it is possible to connect a telephone using normal POTS line** by

- Connect the audio out from the conference telephone to the AUX input.
- Connect the audio input from the conference telephone to the AUX output, which provides a mixed signal between local and far end.

*optional MultiSite package available

** require a conference phone with external audio input and output

5.9 Dual Monitor

Note that this requires a system with dual monitor video output.

5.10 XGA Monitors and Projectors

(Optional)

The system can be delivered with optional single or dual TV/XGA monitors. It can also be connected to any DVI/VGA/PAL or NTSC display.

Note that this requires a system with minimum one DVI-I output.

5.11 VESA Display Power Management

Because of the tremendous amount of energy consumed by monitors when operating, the system will reduce power consumption and extend monitor lifecycle by suspending the (switch off) monitors and projectors when the system goes into sleep/standby.

This applies for all VESA Display Power Management compliant displays that are connected to the VGA/DVI output of the system. The display device need to comply with VESA display Power Management system (DPMS).

Note that this requires a system supplied with a VGA/DVI output.

The VESA DPMS standard consists of four modes, Normal, Standby, Suspend and Off, and applies to all Sync formats (e.g. VGA).

DPMS standard:

	Normal	Standby	Suspend	Off
H-sync	On	Off	On	Off
V-sync	On	On	Off	Off
Power savings	None	Minimal	Substantial	Maximum
Recovery time	None	2-3 seconds	2-3 seconds	8-10 seconds

In Off mode some power may still be drawn in order to power indicator lights etc. EDID contains the information on which mode a specific monitor supports.

TANDBERG supports all four modes. However, in F1 and above, all monitors not listed below are automatically set to Off.

Monitor	DPMS mode
Dell	Off
T8000 - Pioneer	Suspend
T6000 - SAMPO	Suspend
Maestro - Projection Design	Off
T7000 - Sharp	Off

5.12 Digital Monitor Power Management

DMPM is monitor power management applied over the digital DVI interface. TANDBERG supports DMPM in software F2 and above. Six monitor power states are defined.

Monitor On Power state: Transmitter (TANDBERG codec) and receiver (Monitor) are powered and active. This power state is equivalent with the DPMS normal mode.

Intermediate Power state: When the codec goes from active to standby, it turns off the DVI transmitter and the monitor can go from Monitor On

Power state to Intermediate Power state.

Active-off Power state: The monitor can go from Intermediate Power state to Active-off Power state when the monitor timer expires.

Non-Link Recoverable Off Power State: The monitor can enter Non-Link Recoverable Off Power State when the codec is switched off or if the DVI cable is disconnected. This power state is equivalent to the DPMS “Off (with no DPMS recovery)” state.

Monitor Power Switch Off Power state: This state can be entered when the power switch on the monitor is toggled to its off position. This state has two sub-states dependent on if the codec is switched on or off.

5.13 Extended Display Identification Data (EDID)

Extended Display Identification Data (EDID) is a VESA standard data format that will allow the system to communicate its capabilities, including vendor information like the supported VGA-formats and frequency range limits to a PC connected to the XGA/DVI input.

Note that this requires a system supplied with a XGA/DVI input.

This means that the PC always* will be able to output a valid VGA/DVI signal to the system with no manual reconfiguration of the PC screen settings.

TANDBERG supports EDID structure v1.3, which adheres to the MS Plug & Play definition.

This standard contains information on product ID, basic display parameters, timing identifications and detailed timing descriptions.

In F1 and above, TANDBERG will use the EDID information to decide which resolution to use, 800x600 @ 75Hz or 1024x768 @ 60Hz.

Example (1024x768 @60Hz)

Detailed timing description:

PixelClockDiv10000:	6500
Horizontal Active:	1024
Horizontal Blanking:	320
Vertical Active:	768
Vertical Blanking:	38
Horizontal Sync Offset:	24
Horizontal Sync Pulse Width:	136
Vertical Sync Offset:	3
Vertical Sync Pulse Width:	6
Horizontal Image Size:	Not available
Vertical Image Size:	Not available
Horizontal Border:	0
Vertical Border:	0

Tested and verified monitors, EDID & Timing

Listed below are some of the monitors TANDBERG have tested and verified against:

ADI A715
Dell W1700
EIZO L367
EIZO F730
ErgoScan 400S
Hitachi CM640ET
Hitachi CM769ET
IBM 9494-HBO
IBM G97
IBM E74
IBM 6743-60N
JVC LT-23X475
Löewe TAA112747
MAG D700
MAG DJ707
Panasonic SL75
Pioneer PDP-502MXE
Pioneer PDP-50MXE1
Samsung 191T

*Need to comply with the VESA EDID standard.

6 Appendices

Appendices:

- [Appendix 1: Technical Specification](#)
- [Appendix 2: Bandwidth Information](#)
- [Appendix 3: Environmental considerations](#)
- [Appendix 4: Guidelines for setting up videoconferencing rooms](#)
- [Appendix 5: Security](#)
- [Appendix 6: Using the file system](#)
- [Appendix 7: Web Interface](#)
- [Appendix 8: Connecting the system to PRI/T1](#)
- [Appendix 9: Connecting the system to the Switched 56 network](#)
- [Appendix 10: Connecting the system to ISDN using NT1 network adapters](#)
- [Appendix 11: Wave II Camera Pinouts and Connectors](#)
- [Appendix 12: Remote control](#)
- [Appendix 13: CallManager registration](#)
- [Appendix 14: Diagnostic Tools for IP](#)
- [Appendix 15: System Upgrade](#)
- [Appendix 16: Declaration of Conformity](#)

Appendix 1

Technical Specification

Contact your TANDBERG representative for a Technical Specification for TANDBERG 2000 MXP or download from www.tandberg.net.

PRODUCT RELIABILITY / MTBF

The predicted reliability is expressed in the expected random Mean Time Between Failures (MTBF) for the electronic components based on the Power On Hours:

Power On Hours (POH) > 69 000 hours

Useful Life Cycle > 6 years

ISO 9001 certificate is available upon request

Appendix 2

Bandwidth information for TANDBERG endpoints

Model	8000MXP, 7000MXP	6000MXP, Maestro
Bandwidth Point to point ISDN / IP	Standard: 1920 / 4096	Standard: 768 / 3072 Option: 1920 / 4096
MultiSite	Total: 6144kbps 6x1152 video + 5 audio 5x1536 video + no audio 4x1920 video + 5 audio 3x3072 video + no audio	Total: 3072kbps 4x768 video + 4 audio 3x1536 video + no audio Total: 6144kbps 6x1152 video + 5 audio 5x1536 video + no audio 4x1920 video + 5 audio 3x3072 video + no audio
Rate Matching	Yes	Yes
Dual Stream (DuoVideo / H.239)	Yes	Yes
Secure Conference	All bandwidths	All bandwidths
H.264	Up to 2Mbps	Up to 2Mbps
Picture Mode MultiSite	VS, CP4, CP5+1	VS, CP4, CP5+1

Model	3000MXP / 3000NET MXP	2000MXP, 1500MXP
Bandwidth Point to point ISDN / IP	Standard: 384 / 1536 Option: 512 / 1920 3000NET: 384 / 1536	Standard: 1920 (IP only) Options: 512 / 1920
MultiSite	Total: 1536kbps 4x512 video + no audio 4x384 video + 3 audio Total: 2304kbps 4x768 video + no audio	Total: 2304kbps 4x768 video + no audio 4x512 video + 3 audio

	4x512 video + 3 audio	
Rate Matching	Yes	Yes
Dual Stream (DuoVideo / H.239)	Yes	Yes
Secure Conference	All bandwidths	All bandwidths
H.264	Up to 2Mbps	Up to 2Mbps
Picture Mode MultiSite	VS, CP4, CP5+1	VS, CP4, CP5+1

Model	990MXP / 990NET MXP	880MXP / 880NET MXP
Bandwidth Point to point ISDN / IP	Standard: 1920 (IP only) Options: 512 / 1920 990NET: 768 / 1920	Standard: 1152 (IP only) Option: 384 / 1152
MultiSite	Total: 2304kbps 4x768 video + no audio 4x512 video + 3 audio	Total: 1152kbps 4x384 video + no audio 4x320 video + 3 audio
Rate Matching	Yes	Yes
Dual Stream (DuoVideo / H.239)	Yes	Yes
Secure Conference	All bandwidths	All bandwidths
H.264	Up to 2Mbps	Up to 768
Picture Mode MultiSite	VS, CP4, CP5+1	VS, CP4, CP5+1

Model	770MXP	1000MXP
Bandwidth Point to point ISDN / IP	Standard: 768 (IP only) Option: 128 / 768	Standard: 768 (IP only) Options: 128 / 768, 384 / 768
MultiSite	Not Available	Not Available
Rate Matching	Not Available	Not Available
Dual Stream	Yes	Yes

(DuoVideo / H.239)		
Secure Conference	All bandwidths	All bandwidths
H.264	Up to 768	Up to 768
Picture Mode MultiSite	Not Available	Not Available

Model	550MXP
Bandwidth Point to point ISDN / IP	Standard: 768 (IP only) Options: 128 / 768, 384 / 768
MultiSite	Not Available
Rate Matching	Not Available
Dual Stream (DuoVideo / H.239)	Not Available
Secure Conference	All bandwidths
H.264	Up to 768
Picture Mode MultiSite	Not Available

Appendix 3

Environmental considerations

This section explains how to carry out basic adjustments and simple tests to ensure that you send and receive the best possible image and audio quality when using your system.

Iris control and lighting

By default the system camera will use an automatic iris to compensate for changes in lighting. In addition to this feature, you may further assist the system to maintain the best possible image quality by paying special attention to environmental lighting and background colors as described below. Remember the system will send live images of yourself *and* your immediate surroundings.

- Avoid direct sunlight on the subject matter i.e. yourself, the background or onto the camera lens as this will create harsh contrasts.
- If light levels are too low you may need to consider using artificial lighting. As described above, direct illumination of the subject matter and camera lens should be avoided.
- When using artificial lighting, daylight type lamps will produce the most effective results. Avoid colored lighting.
- Indirect light from shaded sources or reflected light from pale walls often produces excellent results.
- Avoid harsh side lighting or strong light from above. Strong sunlight from a window or skylight may put part or all of the subject matter in shadow or cause silhouetting.
- If you still have problems with the iris and lighting, manual adjustment of the camera parameters might help – see Video Settings menu.
- Dim scenes can also be improved by manually adjusting the camera brightness setting.

Background

The appearance of the picture background is very important but easily overlooked. It is important to remember that the camera also shows what is behind you when in a videoconference. To ensure a suitable background we recommend you consider the following:

- Use a neutrally colored background with a medium contrast and a soft texture, e.g. a plain curtain with no heavy patterns or strong colors that may adversely tint the whole scene.
- Avoid moving backgrounds such as curtains blowing in a draught, moving objects, or people walking behind as this may both reduce image quality and distract the attention of the calling party.
- Do not place the camera facing a doorway.

Loudspeaker volume

The audio system will use the Digital Natural Audio Module (DNAM) if available and supported by the system. The volume of the audio system is controlled by the Volume Control keys on the system remote control.

Appendix 4

Guidelines for setting up videoconferencing rooms

The following are a set of guidelines to consider when either building a videoconferencing room, or using an existing room for videoconferencing.

Lighting:

- Low Contrast desired for light intensity. No dark spots.
- Intensity @ table 800 - 1400 Lux as measured with an Incident light meter.
- Block sunlight from entering room.

Seating Area (Table):

- Should allow all participants to see Monitors.
- Should allow camera to “see” all participants.
- Non-shiny non-patterned preferably light grey surface (if table used).

Walls:

- Color: Generally high contrast color desired. Light blue is commonly used.
- Acoustically reflective surfaces (such as glass or concrete) should be covered with curtains or sound treatment.

Audio:

- Noise Floor preferred less than 44dBC.
- Reverb Time 0,3 to 0,5 sec.

Ventilation:

- Keep in mind Noise Floor.
- Velocity = Noise. Therefore keep velocity of air low.

Room:

- Should be located away from noise.
- Should not have windows.
- Doors should be located off camera.

How to prepare a typical room for videoconferencing:

The illustration below shows the principles of a typical room designed to obtain the best results when using a videoconference system.

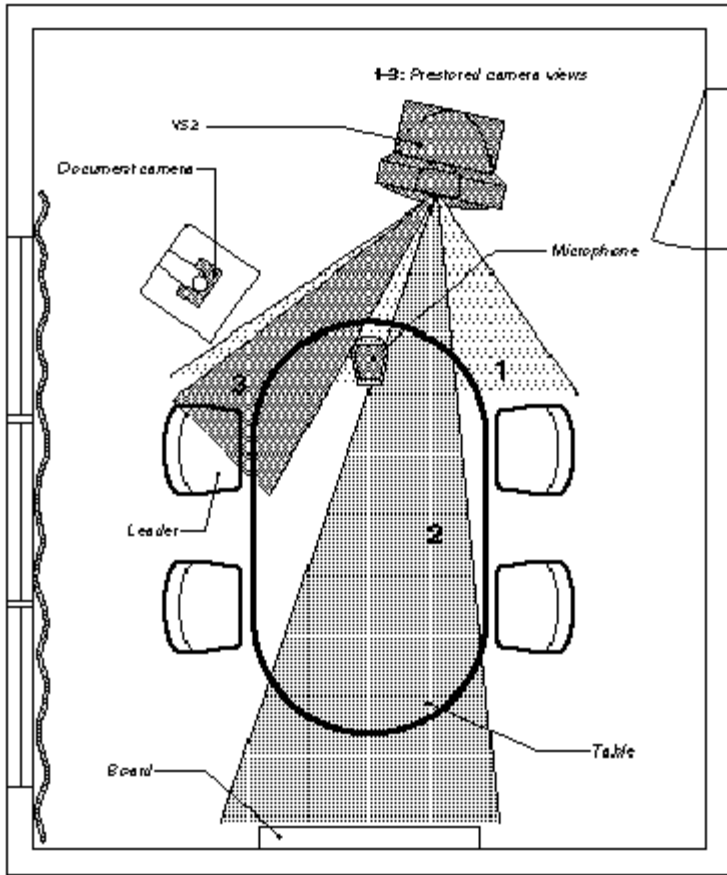

If the system has a separate microphone, it should be placed at the front of the table to ensure that all speech will be detected. The best position for the microphone is at least 2 meters (6.5 feet) in front of the system on a plain, flat table with at least 0.3 meters (12 inches) of table in front of the microphone.

The document camera should be close to the chair person or a designated controller of the document camera for ease of use (remember to arrange all the peripherals so that one participant can reach each of them to point, change the display, tape, and so forth).

The camera supports up to 15 pre-stored camera positions.

The illustration shows three possible camera positions; one for all the participants, one for the whiteboard and one for the main speaker. The remaining camera presets are then available for other peripheral equipment, for example a VCR.

Position the system in such a way as to avoid the possibility of somebody inadvertently walking into the camera's field of view when entering the room. Other than the conference participants, there should be no moving items in the sent image.

Appendix 5

Security

The system has several features both to protect from unauthorized use and system access:

Access Code:

When Access Code is enabled, the user will be asked to enter an access code before he/she is able to make a call. The system will verify if the entered access code is valid by checking the code with the allowed codes listed in the access.txt file on the ftp-server in the system. If no access.txt file is uploaded to the system, registration of the code will be done without validation. E.g. you can enter whatever code you want and have access to the system.

The access.txt file is a plain text file with one line per access code as shown below:

```
1234
1250
A1
B2
ABC
```

To upload this file to the system, follow these steps:

- Open a DOS-window and go to the folder where the 'access.txt' file is located.
- Type ftp <IP-address of your local system>.
- User: press Enter or enter IP-password.
- Type "bin" and press Enter.
- Go to the user folder, type "cd user".
- Upload the 'access.txt' file, type 'put access.txt'.
- Exit from ftp, type "bye".

Administrator Password

Access to the administrator menu on the system unit can be controlled using password protection. You can set the Administrator Password in Menu Settings, in Security or from the dataport:

menupassword set <pin-code>. The pin-code should be maximum 5 - five digits. To erase the password, enter an empty pin-code.

Streaming password

By setting a streaming password in the streaming menu on the system, a password has to be entered on the streaming client to be able to see the video stream from the system.

IP Password

By setting an IP Access Password on the system, all access to the system using IP (Telnet, FTP and WEB) requires a password. This password can be enabled from telnet or dataport using the command: `ippassword <ip-password>`. The default IP username and password is "TANDBERG". To remove this password, use the command: `"ippassword "`. From telnet, this is only possible by first entering the correct password.

IP Services

The different IP services on the system - FTP, Telnet, Telnet Challenge, HTTP, HTTPS, SNMP and H.323 can be disabled to prevent access to the system. By using the commands below, the services can be independently enabled/disabled:

```
xconfiguration Telnet/TelnetChallenge/FTP/HTTP/HTTPS/H323 Mode: <On/Off>
xconfiguration TelnetChallenge Mode: <On/Off> [port]
xconfiguration SNMP Mode: <On/Off/ReadOnly/TrapsOnly>
```

SNMP Security alert

This function will notify any Management Application (such as TMS - TANDBERG Management Suite) if anyone tries to perform Remote Management on the system using an illegal password. The Security alert that is sent to the Management Application will contain information about the IP address and the service (WEB, Telnet, FTP) being used for the attempt. If TMS is used, email notifications or alarms about the attempt can be sent to specified persons.

Encryption

All TANDBERG systems support both AES and DES encryption. By default this feature is enabled such that when connecting with any other video system or MCU, a TANDBERG system will attempt to establish a secure conference using AES or DES encryption. The TANDBERG system will attempt this for both IP and ISDN connections. Where a remote system or MCU supports encryption, the highest common encryption algorithm will be selected on a port-by-port basis.

The type and status of the encryption negotiated is indicated by padlock symbols and on-screen messages. Encryption on the TANDBERG systems is fully automatic, and provides clear security status indicators;

- An open padlock indicates that encryption is being initialized, but the conference is not yet encrypted.
- Single padlock indicates DES encryption.
- Double padlock indicates AES encryption.

In addition to on-screen indicators the Call Status menu provides two information fields regarding call encryption. The first field is the Encryption Code, which will identify either AES or DES. The second field is the Encryption Check Code and is comprised of an alphanumeric string. This string will be the same for systems on either side of an encrypted conference. If the Check Codes do not match, this would indicate that the call has been exposed to a Man In The Middle attack.

When a system with MultiSite functionality hosts a conference, the highest possible encryption algorithm will be negotiated on a site-by-site basis. MultiSite conferences can therefore support a mix of AES and DES encrypted endpoints in the same conference. A conference will only be as secure as its weakest link.

All systems supporting DES encryption can upgrade to AES encryption. Please contact your TANDBERG representative for more information. The standards supporting the encryption mechanisms employed by TANDBERG are: AES, DES, H.233, H234 and H.235 (H235v3 & v2 for

backwards compatibility) with extended Diffie Hellman key distribution via H.320, H.323 and Leased Line connections.

The TANDBERG AES implementation is validated as conforming to the Advanced Encryption Standard (AES) Algorithm, as specified in Federal Information Processing Standard Publication 197, *Advanced Encryption Standard*, by The National Institute of Standards and Technology (NIST).

Appendix 6

Using the file system

It is possible to access a file system within the TANDBERG system by using ftp:

DOS-window:	ftp <IP-address of system>, or
Web-browser:	ftp:// <IP-address of system>

Description of the different files:

all.prm	all settings in the system (including directory)
dir.prm	directory entries (up to 200 entries)
event.log	logs fault situations etc.
sw.pkg	the system software
globdir.prm	file containing up to 400 entries. These entries can not be edited from the system, but can be edited as a text-file.

Files accessible only by 'ftp get /tmp/snapshots/xxx.jpg' or 'http://<IP-address of system>/tmp/snapshots/xxx.jpg':

site0.jpg	Snapshot of current stream if MultiSite.
main.jpg	Snapshot of selfview.
site1.jpg	Snapshot of decoded stream if point-to-point.
duo.jpg	Snapshot of the encoded stream if transmitting DuoVideo, the decoded stream if receiving DuoVideo.

Custom logos

- Go to the folder where your logo is located.
- Type "ftp <IP-address of your local system>".
- Go to the user folder, type "cd user".
- Upload the logo, type "put <logo.jpg>".

The new logo will be displayed the next time you restart your system. Recommended maximum size is: 704x576, file-format: jpg. If the file is too large, no logo will be displayed.

Appendix 7

Web Interface

It is possible to access and maintain the system remotely via a local area network (LAN) using a standard Web-browser. Connect your system to a LAN with a Network cable.

How to configure your system for web interface:

1. Open Administrator Settings and choose Network\[LAN Settings](#)
2. Specify IP-assignment DHCP or Static. If DHCP is selected, no other settings are needed. If Static is selected, IP-address, IP-subnet mask and Gateway must be specified.
3. Start your Web-browser. In the address field type the IP-address of the system. Enter the password and the Web-page of the system will be shown. The default password is TANDBERG.
4. Restart the system. Choose Restart from the Control Panel.

Example:

IP-assignment:	Static
IP-address:	196.9.200.129
IP-subnet mask:	255.255.255.0
Gateway:	196.9.200.21

Appendix 8

(Not available on all TANDBERG systems)

Connecting the system to PRI/T1

Using CSU adapter

Connecting the system to the ISDN network via the E1/T1-interface using an Adtran T1 ESF CSU ACE or equivalent CSU, will allow up to 1.54 Mbps connection. The E1/T1-interface must be connected to a CSU approved according to IEC 60950, UL 1950 or equivalent standard. The PRI-line will run the AT&T 4ESS, 5ESS and National ISDN protocols in addition to Euro ISDN (E1).

Connecting to Adtran T1 ESF CSU ACE

Connect the PRI cable from the system to the input marked CPE (Customer Provided Equipment) on the Adtran CSU (straight through category 5 cable is recommended). Connect to the network via the NET connector on the Adtran CSU.

Configuration of the system

Open the Administrator Settings Menu from the Control Panel and select Network. Choose Network Type: PRI and specify your PRI number, max. Channels, cable length (between system and CSU) and switch type.

Configuration of Adtran T1 ESF CSU ACE

- Enter 2)CONFIG menu using SCROLL and ENTER buttons.
- Enter 3)TERMINAL menu. Check 1)FORMAT:ESF, 2)CODE: B8ZS , 3)SET LBO: 0-133 (corresponding to Cable Length setting on the system).
- Go to main menu and enter 1)NETWORK menu. 7)SET LBO: 0.0 (according to information from Telco).
- Also, other network parameters should be set according to information from your Telco.

Appendix 9

Connecting the system to the Switched 56 network

Using Telesync TS-256 SW56/ISDN adapter

Connecting the system to the SW56 network using a Telesync Adapter is described below. There are different Telesync Adapters for different configurations of SW56 networks. The network types tested with the system are SW56 2Wire and 4Wire.

Connecting

Connect the system ISDN1 cable to the BRI S/T interface on the Telesync Adapter. Connect the two SW56 cables from the Telesync adapter Line 1 and Line 2 to the SW56 network.

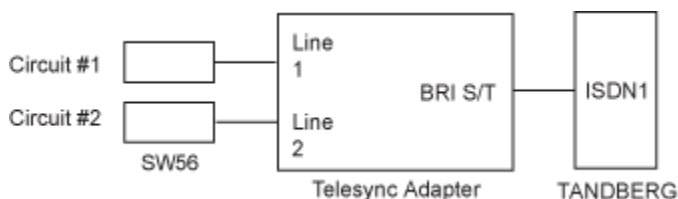

Configuration of the system

Select network type to National ISDN.

LINE 1 SETUP

NUMBER1: program with number from the first SW56 line
 NUMBER2: program with number from the second SW56 line
 SPID1: program with number from the first SW56 line
 SPID2: Leave blank

How to call

It is important to use Restrict (56k). Select Restrict (56k) in Call Settings in the Call menu (select the field next to the phone book button in the call menu). A second number field will appear when ISDN is selected for Net within Call Settings and you choose bandwidth 128 kbps. Enter the second number in the call settings menu.

Appendix 10

Connecting the system to ISDN using NT1 network adapters

Connecting

Connect the first ISDN cable from ISDN 1 on the system to the S-interface on your first NT1 network adapter. Connect the other ISDN cables to the appropriate NT1 network adapters. Connect the U-interface of your NT1 adapter to the line provided from your network provider.

For convenience the NT1 adapters could be placed inside the cabinet. If needed, use the shorter ISDN cable (RJ45 connectors) delivered with the NT1 between the codec and the NT1 and the longer ISDN cable between the NT1 and the connector (RJ45) at the wall socket.

Configuring

The configuration of the system is performed in the same manner as described in ISDN BRI Settings.

The NT1 should be powered up and you should check that the network is active. Please check your NT1 User Manual.

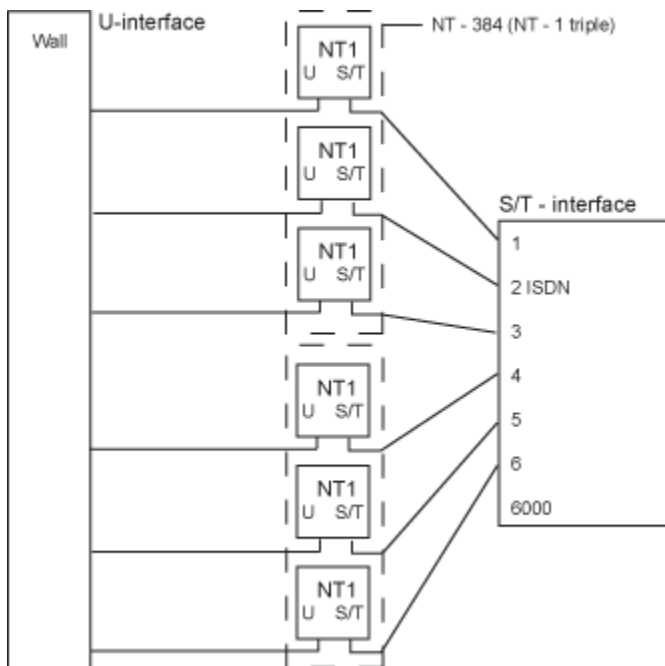

Appendix 11

(Not available with set top systems)

WAVE II Camera

Pinouts and Connectors

8-PIN RJ (shielded modular jack):

This connector is used for the power and control signals to the main camera.

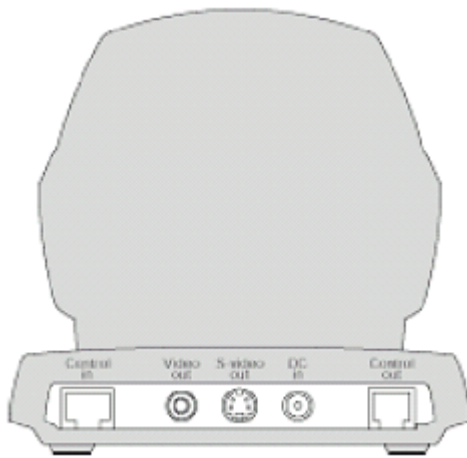

Pin-8	+12V (presence when connected in daisy chain)
Pin-7	GND
Pin-6	GND
Pin-5	RXD (in)
Pin-4	TXD (out)
Pin-3	+12V
Pin-2	GND
Pin-1	+ 12V

Standard Phono:

Used for composite video signal

Power:

2.0 mm DC power jack (+12V, 1A required)

Standard Mini Din:

Used for S-Video signal

6-PIN RJ (modular jack):

This connector is used when cascading cameras: Control (out) signal and external camera detection. Note: It does not provide power for cascaded camera.

PRI	Pinout
Pin-6	GND
Pin-5	GND
Pin-4	RXD (in)
Pin-3	TXD (out)
Pin-2	Presence (+12V in daisy chain)
Pin-1	GND

Appendix 12

Remote Control (TRC 3)

The TANDBERG remote control transmits IR-signals using the following parameters:

Protocol	Siemens SDA2208
Reference frequency	485kHz
Address	4 & 7
IR wavelength	940nm
IR carrier frequency	30kHz

Remote Control keycode map:

Button codes		Remote control		Button codes		Remote Control	
Decimal	Hex	Address	Button name	Decimal	Hex	Address	Button name
0	00			33	21	0	OK
1	01	0	NUMBER 1	34	22	0	CALL
2	02	0	NUMBER 2	35	23	0	END CALL
3	03	0	NUMBER 3	36	24	0	PHONE BOOK
4	04	0	NUMBER 4	37	25	0	MENU
5	05	0	NUMBER 5	38	26	0	CANCEL
6	06	0	NUMBER 6	39	27	0	
7	07	0	NUMBER 7	40	28	0	PRESETS
8	08	0	NUMBER 8	41	29		
9	09	0	NUMBER 9	42	2A		
10	0A	0	NUMBER 0	43	2B		
11	0B	0	*	44	2C		
12	0C	0	#	45	2D		
13	0D			46	2E		
14	0E			47	2F		
15	0F			48	30		
16	10			49	31		
17	11		PRESENTER	50	32		

18	12	0		51	33		
19	13			52	34		
20	14			53	35		
21	15			54	36		
22	16	0	ZOOM OUT	55	37		
23	17	0	ZOOM IN	56	38		
24	18			57	39		
25	19	0	VOLUME DOWN	58	3A		
26	1A	0	VOLUME UP	59	3B		
27	1B	0	MIC OFF	60	3C		
28	1C			61	3D		
29	1D	0	UP	62	3E		
30	1E	0	DOWN	63	3F	0	WAKE UP
31	1F	0	LEFT	25	19	3	LOW BATT
32	20	0	RIGHT	XX		3	PROG VER

Appendix 13

Cisco CallManager registration

Configuring an H.323 client on the CallManager 4.0

The registration of a H.323 client in CallManager is supported on the CallManager (CCM) 4.0 software and forward.

1. To configure the CallManager with an H.323 client, log on to the administration web interface and go to the phone configuration page.
2. The Phone configuration page is located on: device (top menu) -> Add a New device -> Phone -> H.323 Client.
3. In the phone configuration page type the IP address of the TANDBERG system in the Device name field, select device pool and push the insert button.
4. A pop-up box will now appear on the screen and ask you if you would like to configure the directory number. Push the ok button.
5. You should now see the Directory Number Configuration WEB page. Enter the E.164/phone number of your TANDBERG system in the Directory number field, and in the "Forward and Pickup Settings" enter the time of "No Answer Ring Duration". The time selected has to have a value from 1 to 300 seconds.
6. Push the Add button to update the CallManager with the directory number settings.

You have now configured the CallManager with a H.323 client and should be able to register the TANDBERG system to it. When the TANDBERG system is registered to a CallManager, it will be possible to place and receive calls from this system to any other video and voice systems that are registered on the same CallManager.

Appendix 14

Diagnostic Tools for IP

To use these tools, will require using a PC and setting up a telnet session towards the system.

Q.931

To show Q.931 trace during a call you need to issue the command 'syslog on'. One can get traces for RAS, Q.931 and H.245 with this command. It is a complex trace and requires an extensive knowledge in H.323 signalling to be understood.

Ping

Ping is used to see if the system is able to reach a specific IP-address, using a mechanism in IP called ICMP. If the system is unable to register to its gatekeeper, or if it is unable to dial a specific endpoint, one can use ping to see if there is at least an IP-route to the gatekeeper or to the endpoint. In case you have problems, one would first ping the default gateway, then the gatekeeper, and then the other endpoint.

Traceroute

Traceroute does exactly that; it traces the route an IP-packet takes to reach its destination and displays all router hops. Traceroute is very useful for seeing exactly where there is a routing-problem in the IP-network, and for checking where transport-delay is introduced.

Layer 4 Ports used in H.323 calls

The layer 4 ports used by the system in a H.323 call can be defined as follows:

- Dynamic: The ports are allocated at random from 2048 to 65535.
- Static: Will use the predefined layer 4 ports listed in the tables below.

Point-to-point + Duo Video

Function	Port	Type
Gatekeeper Discovery (RAS)	1719	UDP
Q.931 Call Setup	1720	TCP
H.245	Range 5555-5565	TCP
Video	Range 2326-2341	UDP
Audio	Range 2326-2341	UDP
Data/FECC	Range 2326-2341	UDP

MultiSite + Duo Video

Function	Port	Type
Gatekeeper Discovery (RAS)	1719	UDP
Q.931 Call Setup	1720	TCP
H.245*	Range 5555-5565	TCP
Video	Range 2326-2405	UDP
Audio	Range 2326-2405	UDP
Data/FECC	Range 2326-2405	UDP

(*) Note: While using MultiSite, if a site is disconnected and reconnected without terminating the entire conference, the next site to be connected will have a H.245 port outside of the specified range. If this functionality is required through a firewall, the range of TCP ports can be extended past 5564. However, if a site is disconnected and reconnected, without ending the conference enough times one can quickly end up outside of this range again.

Appendix 15

System Upgrade

Before starting the software upgrade of the TANDBERG MXP system, please make sure to have the new software file, (for instance s050000F30.pkg) and the Release Key for this software available. Your TANDBERG Partner will provide this for you.

All options and settings will automatically be stored when upgrading, so no backup is necessary.

If the system upgrade process is aborted before it's complete, the system will work as normal with the original software

The TANDBERG MXP systems can be upgraded in three different ways;

- **Using the web interface**
- **Using FTP**
- **Using ISDN**

A) To upgrade using the the web interface, please do the following steps:

1. Type the IP address of the TANDBERG MXP system that shall be upgraded (for instance 10.0.8.77) in a standard browser, such as Internet Explorer 6.0.
2. The web interface of the codec will then be displayed. Select the 'System Configuration' tab on top of the page, and then the sub-tab 'Upgrade'.

The following page will now be displayed:

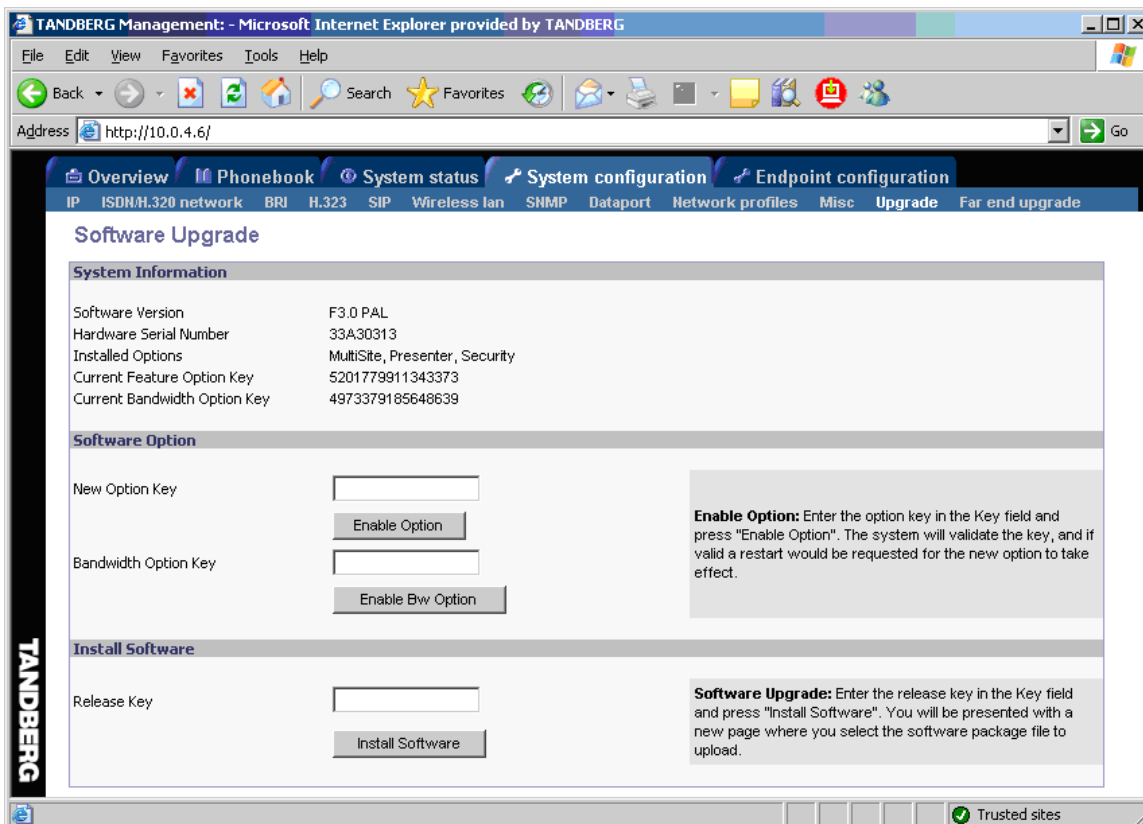

Figure 1

3. Enter the Release key in the 'Release Key' field and press the 'Install Software' button.

A new page will now be displayed:

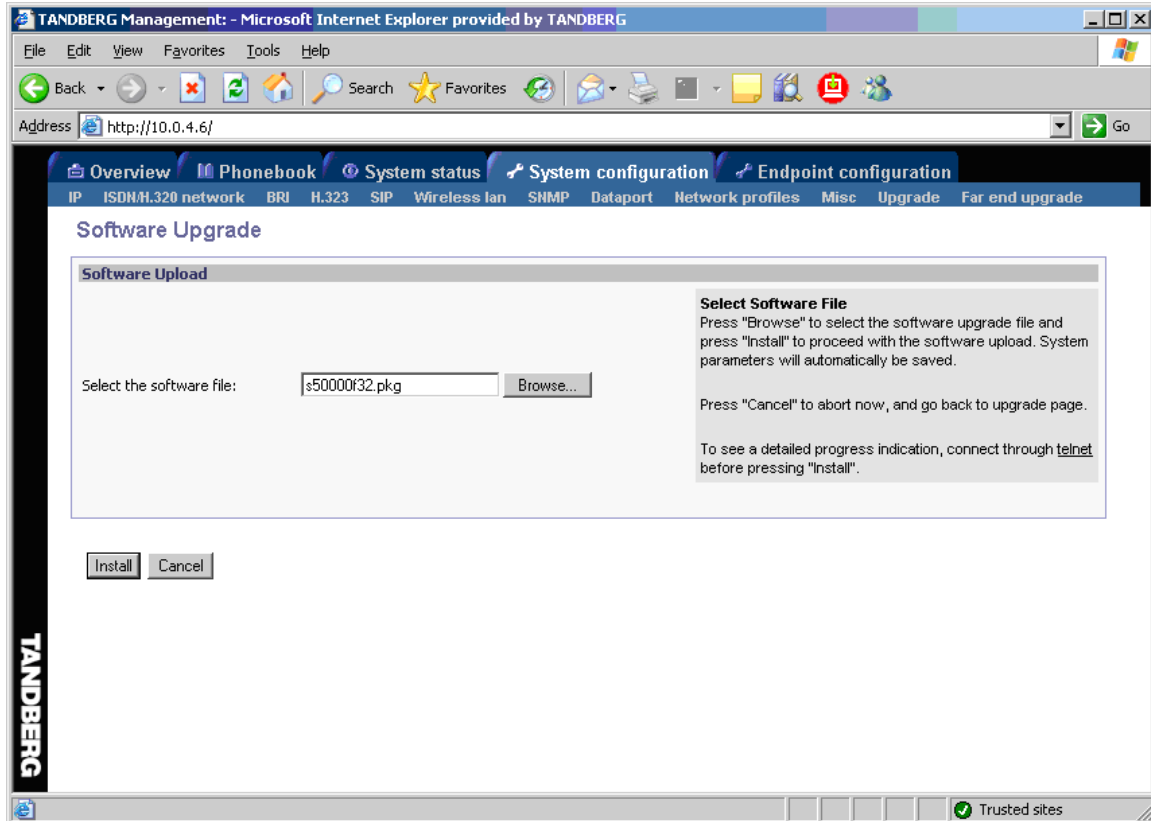

Figure 2

4. Type in the path to where the new software file is stored, or select the file by using the 'Browse' button.
5. The progress for the sw upgrade can be tracked by pressing the 'telnet' link in the help text box BEFORE pressing the install button. Please note that this is not a necessary action for a successful software upgrade. An indication of the software upgrade progress will also be shown on the display of the system
6. Press the 'Install' button to start the software upgrade.

When the software upgrade is complete, you need to click on the restart button and press OK to restart the system in order to activate the new software. Once verified, the system will reboot once more to complete the upload of all systems parameters kept from the old software revision.

7. To verify that the new sw is installed, refresh the page shown in figure1 after restart. The 'Software Version' should now show the new software version uploaded to the system. The same information can also be found in the menu on the system under 'Control Panel/System Information'.

B) Upgrading using FTP:

1. Copy the new software file to a folder on your harddisk, for instance c:\software.
2. Open a DOS window, and go to the folder where the new software is stored.
3. Type ftp <ip address of the TANDBERG MXP system>.
4. Type in the supplied 'Release Key' as user.
5. Type in your IP password (default is "TANDBERG") as password.

6. Type 'put <software file name>' and press Enter. The new software file will now be uploaded to the TANDBERG MXP system.
7. When the software upload is complete, end the ftp connection to the TANDBERG MXP system by typing 'bye' in the DOS prompt.
8. To exit the DOS window completely, type 'exit'
9. Restart the system to activate the new software.

C) ISDN Upgrade

The TANDBERG MXP systems has the possibility to be upgraded remotely from another TANDBERG MXP system using ISDN. Please note that both systems must be on software version F3.0 or newer for this functionality.

Please also note that both systems must be on software version F3.0 or newer for this functionality

1. Connect to the system that shall be upgraded using ISDN
2. Copy the new software file to a folder on your computer, for instance c:\software.
3. Type the IP address of the TANDBERG MXP system that the software upgrade is going to be done from (for instance 10.0.8.77) in a standard browser, such as Internet Explorer 6.0. The web interface of the codec will then be displayed.
4. Select the 'System Configuration' tab on top of the page, and then the sub-tab 'Far end upgrade'.

The following page will now be displayed:

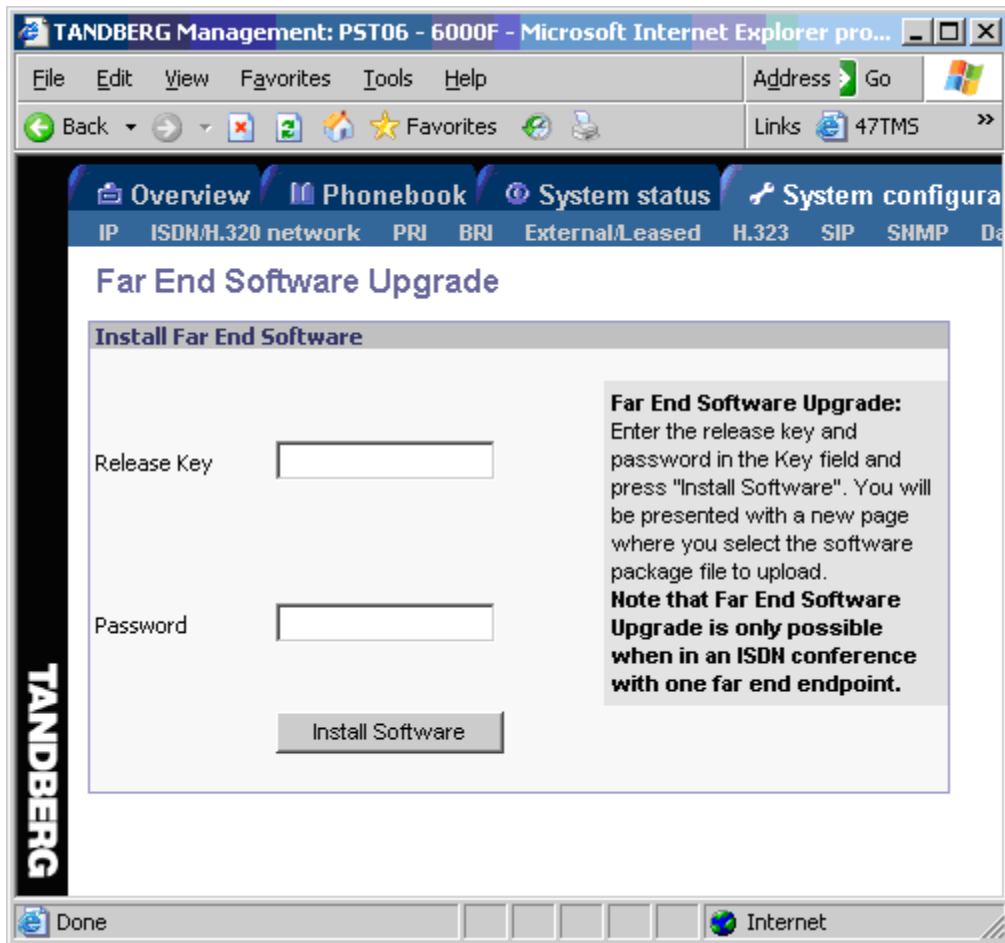

Figure 3

5. Enter the release key for the system to be upgraded in the 'Release Key' field. If no release key is given, the Far End System will use the previously stored release key if possible. This will work when upgrading from a main release to a dot release.
6. Make sure the setting "Far End System Upgrade" is set to "On" at the remote site. This setting can be found in the Administrator Settings/General/Permissions menu.
7. Enter the password set at the far end for remote upgrade (default password is "TANDBERG")
8. Press 'Install Software'. The system will now use about 90% of the call capacity to transfer the software file across. During this time, audio and video will be turned off.
9. Once the software has been transferred and verified at the far end, you will get a new webpage with information that the upgrade of the far end was successful. At the same time, a message box will appear at the remote system asking if you want to reboot the system to activate the new software.
10. To activate the new software. The ISDN connection needs to be closed, and the TANDBERG MXP system must be rebooted.

In the menu on the system under 'Control Panel/System Information', the installed software should now be displayed as the 'Software Version'.

Appendix 16

Declaration of Conformity

Contact your TANDBERG representative for a Declaration of Conformity.

7 Index

A

Access Code.....	87, 110
Add Another Call.....	33
Additional microphone	200
Administrator Password.....	126
Administrator Settings	103
Alert Speaker	155
Alert Tones and Volume	155
Allowance	110
Answer an incoming Call	38
Assign Floor to Participant.....	80
Audio	
Inputs	149
Outputs.....	151
Audio Algorithm	139
Audio Demo	99
Audio Leveling (AGC)	154
AudioScience microphone.....	200
Auto answer	107
Auto-Display Snapshot	133
Automatic Camera Tracking	64

B

Battery handling.....	iii
-----------------------	-----

C

Call history	46
Call Settings.....	35
Call Status	89
Camera Presets.....	61
Camera Tracking Mode	157
Codec	4
Connecting cables	10
Contact us.....	vi

D

Default Call Settings	145
Digital Clarity.....	143
Disconnect Participant.....	82
Display snapshot	71, 72
DNAM	201
Do Not Disturb	43
Document camera	197
Dual Monitor	205
Dual Stream.....	70, 128, 129, 131
Dual Video Stream.....	70, 128, 129, 131
Duo Video	70, 128, 129, 131
Duo Video Quality.....	143

E

Echo Control	152
EDID	209
Encryption.....	165
End Call	39
Extra cameras.....	199

F

Far End Camera Control.....	59
Far End Control.....	60

G

Gatekeeper	176
Group Layout	77

H

H.239	70, 128, 129, 131
H.323 Settings	175
Hardware serial number	87

I

Indicators	26
Interfaces	192
IP Address Conflict Check	95
IP Settings.....	174

L

Language	105
Last number dialed	46
Layout	21
Letter keys	24
Logo	122

M

Max Call Length	108
MCU	84
MCU Status Line.....	158
Menu timeout in call.....	119
Mic off	22
Microphone	4, 200
Missed calls	46
MultiSite	84
MultiSite (Built-in).....	84

N

Natural Video	141
Navigation	19
Network Profiles.....	188
Number keys.....	24

P

Password	175
PC Presenter	68
PC Soft Presenter	69
PC SoftPresenter.....	69
Permissions	110
Phone Book	
Delete	53
Edit	52
MultiSite.....	50
New	49
Picture Control	63
PIP Appearance.....	134
PIP Placing	135
Postpone 1 hour.....	41

Postpone 3 hours.....	42	Telephone Add-On.....	204
Presentation		Telephone Call.....	32
Presentation Key.....	66, 131	Terminate Meeting.....	83
Presentation Menu.....	67	Test Subsystem	90
Presentation Source	131	Text Chat	98
Presets.....	61	Timeout	119
Production of products.....	iii	To connect a PC to Dataport 1	189
R		Touch Tones	25
Release Chair	79	U	
Release Floor	76	User Guide.....	102
Release Floor from Participant.....	80	V	
Request Floor	76	Video Algorithm.....	138
Restart	101	Video Call.....	31
Restore defaults.....	190	Video cassette recorder (VCR).....	198
S		Video Name	163
Screen Settings	112	Video Quality.....	143
Search	56	View Administrator Settings.....	91
Selfview	20	View Site	81
SIP	180	VNC Settings	136
Snapshot.....	71, 72	Volume + and -	23
Snapshot Source	132	W	
Software Options	117	Warnings.....	96
Stereo I/O mode	153	Waste handling	iii
Stereo speakers.....	153, 203	WAVE II camera	4
Streaming	36	Web Snapshots.....	160
System configuration	13	Welcome menu	120
System Information.....	87	Welcome Picture.....	121
System Name	106	Welcome Screen.....	16
T		Welcome text	124
Take Chair	79	X	
Take new snapshot	71, 72	XGA	112

8 Glossary

#

199 AV1: External input for the TANDBERG/LOEWE monitor.

2nd monitor: The second monitor of your videoconferencing system. The second monitor is normally placed on the right side of the first monitor.

4CIF: 4 times CIF, 704x576 pixels

4SIF: 4 times SIF, 704x480 pixels

A

AACLD: Advanced Audio Coding Low Delay

Access code: Use Access code to password protect outgoing calls.

Accessories box: The cabinet contains the following: W.A.V.E. camera, table microphone, remote control and tracker and documentation.

Accessories drawer: See Accessories box

AES: Strong encryption. (Advanced Encryption Standard)

AGC: Automatic Gain Control. Maintains the audio signal level at a fixed value by attenuating strong signals and amplifying weak signals. Very weak signals, i.e. noise alone, will not be amplified.

Alert speaker: The internal speaker will warn you of an incoming call even though the monitor may not be switched on.

Audio call: Audio call equals a telephone call. You can make a call with the video system with audio only.

Audio input 4: Intended for connection to an external microphone amplifier or an external fixed mixer.

Audio input 5: Intended for connection to external playback devices (or to telephone add-on hybrids).

Audio input 6: Intended for connection to a VCR or DVD player or other external playback devices.

Audio out 1: Intended for connection to TANDBERG Natural Audio, televisions or audio amplifiers.

Audio out 2: Intended for connection to audio recording equipment (or to a telephone add-on hybrid).

Audio out 3: Intended for connection to a VCR or other recording equipment.

Auto-display snapshot: Sent and received snapshot will automatically appear on full screen display.

Auto answer: The system will automatically answer all incoming calls.

Automatic Duo Video: Duo Video Mode is put to Auto. When starting a presentation, Duo Video will start automatically (if possible).

B

Bandwidth: Decides the quality of the video call. High bandwidth gives high quality.

C

Call control Leased Line: Is a non-dialing protocol and should be used when two systems are connected in a point-to-point connection. Use Leased Line when the handshaking signals DTR and CD are available.

Call control Manual: Should be used when no handshake signals are available, and the external equipment requires a constantly connected line.

Call control RS366 Dialing: The only dialing protocol and would normally be used together with network clocking RS449/V35 Compatible when the external system uses RS2366 ports.

Call status: Comprehensive information about the call listing transmitted and received audio/video/data information.

Camera tracking: Voice Activated Camera Positioning - the camera will automatically view the current speaker.

Camera tracking mode: Voice Activated Camera Positioning - the camera will automatically view the current speaker.

Chair control: Enables one participant to control the meeting by selecting which of the conference participants that is to be broadcasted to the other participants.

Channel status: Comprehensive information about the call progress listing the numbers called, and if an error occurs a cause code is displayed.

CIF: Common Intermediate Format, 352x288 pixels

Closed Captioning: Text chat.

Codec: The Codec is the heart of the system. The main task for the Codec is the compression of outgoing video, audio and data, the transmission of this information to the far end, and the decompression of the incoming information.

Continuous Presence: See Split Screen

Control Panel: The Control Panel is found in the main menu.

CSU: Channel Service Unit

D

Daisy-chaining: Use of several cameras in a video conference.

Dataport: The system provides two standard RS 232 data ports to allow a computer to be connected for data transfer and control purposes.

Dataport 1: A standard RS 232 data port to allow a computer to be connected for data transfer and control purposes.

Dataport 2: Dedicated to the main camera and will not be available in standard configuration.

DES: Encryption. (Data Encryption Standard)

DHCP: Dynamic Host Configuration Protocol.

Diagnostics: Allows testing of individual system components and displays the current system settings.

Digital ClarityTF: Participants enjoy presentations of exceptionally high quality resolution video.

Disconnect site: As a Chairman, you get the option Disconnect site. Disconnect site allows you to disconnect any participant in the conference.

Do Not Disturb: When Do Not Disturb is active the system will not accept any incoming calls. The caller will hear a busy tone when calling the unit.

Document Camera: A document camera is an additional camera that is used for showing text, diagrams as well as physical objects.

DownspeedingTF: If channels are dropped during a videoconferencing session, the connection is automatically maintained without interruption.

dual monitor: The second monitor

Dual monitor system: A videoconference system with two monitors.

Duo VideoTF: Allows participants at the far end to simultaneously watch a presenter on one screen and a live presentation on the adjoining screen.

E

E.164 Alias: The E.164 address of the system. Equivalent to a telephone number, sometimes combined with access codes. The system will not register with the gatekeeper if the E164 alias is not set.

E1: Network type, 30 channels. Default for PAL versions.

Echo canceller: Continuously adjusts itself to the audio characteristics of the room and compensates for any changes it detects in the audio environment.

Echo control: When set to On the far end is prevented to hear their own audio.

Encryption: Use encryption to make a secure call. The system will try to make point-to-point calls using encryption. If the far end system supports encryption, the call will be encrypted. If not, the call will proceed without encryption. (Auto encryption). Set encryption to On if you don't want an unencrypted call to be established at all. Set encryption to Off if you don't want to use encryption.

End view: Stop viewing the site previously chosen with View Site, and return the view to the site that is currently On Air. Can be used by all conference participants.

Ethernet Speed: The speed (Mbps) on the connection from the system to the LAN.

F

Fallback to telephony: Enables fallback from video calls to telephony/speech calls.

Far End: In a video conference, Far End means the remote side of the conference. Far End Camera is your conference partner's camera. Opposite to Near End

FECC: Far End Camera Control. When activated it is possible to control the far end's camera, select video sources, activate presets and request still images.

Floor: In a multipoint call, use Request Floor to broadcast your picture to all other participants. This is handy when you are having presentations, for teachers etc.

G

G.711: Audio algorithm for normal quality audio (telephone quality, 3.1 kHz) The system will always have G.711 enabled.

G.722: Audio algorithm for high quality audio (7 kHz).

G.722.1: Audio algorithm for compressed high quality audio (7 kHz)

G.728: Audio algorithm for compressed normal quality audio (telephone quality, 3.1 kHz)

Gateway: The gateway enables sites on IP and sites on ISDN to participate in meetings with each other.

Global Phone Book: A phone book provided by TMS.

H

H.261: Video algorithm for legacy video compression and decompression. The system will always transmit H.261

H.263: Video algorithm for normal video compression and decompression

H.264: Video algorithm for bandwidth-efficient video compression and decompression

Hardware serial number: A unique number (listed in the System Information menu) to identify your system towards your TANDBERG representatives.

Humfilter: A highpass filter which reduces very low frequency noise.

I

iCIF: Interlaced CIF, 352x288 pixels, 50 fields per second

Incoming call: Someone calls in to your system

Incoming MCU Calls: If occupied in a call, the system will provide a visual/audio indication of an incoming call and ask to accept or reject the call.

IP address: Defines the network address of the system. This address is only used in static mode.

IP assignment: IP-address, IP-subnet mask and Gateway are assigned by the DHCP server.

IP assignment Static: The system's IP-address and IP-subnet mask must be specified in the IP-address field.

IP Precedence: Used to define which priority the system should have in the network. Higher numbers indicate higher priority.

IP subnet mask: Defines the type of network. This address is only used in static mode.

IP TOS: IP Type Of Service. Helps a router select a router path when multiple paths are available.

iSIF: Interlaced SIF, 352x240 pixels, 60 fields per second

L

Layout: Use the Layout key to change picture layout on the screen.

M

Main Camera: Your camera. Video input 1

Max call length: This feature will automatically end both incoming and outgoing calls when the call time exceeds the length specified.

- Max channels:** Indicates the maximum number of channels the system is allowed to use on the E1/T1 interface.
- MCU:** Multipoint Conference Unit.
- MCU status line:** Shows indicators for MultiSite, MCU and DuoVideo
- MicOff:** Microphone is switched off.
- Mix mode:** How to adjust the weighting of each microphone to obtain the best possible audio and minimize the background noise.
- Modem mode:** (Dataport) Supports external control of the system via a PC as in Control Mode. Once a call is established, Dataport 1 will automatically switch to Data mode. When the call disconnects, Dataport 1 switches back to Control Mode.
- MSN:** Multiple Subscriber Number. Possible to attach different ISDN terminals, with different numbers, to the same physical ISDN telephone line. The service can be ordered from the telephone company.
- multipoint call:** A call with more than two participants including yourself
- MultiSite:** The TANDBERG systems internal MCU. Built-in system which makes it possible to establish meetings with up to 6 video calls and 5 telephone calls. The MultiSite option is not available on all systems.
- MultiSite cascading:** By connecting up to 4 MultiSite systems together to achieve a higher number of participants in a multipoint call.

N

- NAT:** Network Address Translation. NAT support in the videoconferencing system enables proper exchange of audio/video data when connected to an external videoconferencing system when the IP traffic goes through a NAT router. Used in small LANs, often home offices, when a PC and a videoconferencing system is connected to a router with NAT support.
- NAT Address:** The external/global IP-address to the router with NAT support. Packets sent to the router will then be routed to the system's IP address.
- Natural Audio Module™:** Designed to improve audio quality during a videoconference. It is mounted in the cabinet above the Codec and consists of an audio system optimized for speech.
- Natural Presenter Package:** Consists of Duo Video, Digital Clarity and PC Presenter.
- Natural Video™:** 60 fields per second true interlaced picture.
- Near End:** In a video conference, Near End means your own side of the conference. Near Camera is your own camera. Opposite to Far End
- Network clocking:** Specifies the number of physical external clock signals.
- Network Interface:** Indicates if the network is of type E1 or T1.
- Network profiles:** It is possible to define up to 6 network profiles, each consisting of name and call prefix, and 3 of them also include network selection.
- Non Standard Facility:** The network provider may require service selection in your ISDN configuration. Valid NSF codes are from 1 to 31. 0 will disable NSF service codes.
- NR:** Noise Reduction. Reduces constant background noise (e.g. noise from air-conditioning systems, cooling fans, etc.).
- NSF:** Non Standard Facility.

NTSC: National Television System Committee. Video standard corresponding to 4SIF. Primary used in USA, Japan and other countries.

O

Option Key: Required by the system to activate optional features such as MultiSite and Presenter.

P

PAL: Phase Alternation by Line. Video standard corresponding to 4CIF. Primary used in Europe, Middle East and Asia

Parallel dial: Channels will be dialed and connected in parallel when setting up a bonding call.

PC PresenterTF: An easily accessible PC connection plug. When connected the PC image is displayed on the monitor.

PC SoftPresenterTF: Shows PC images via the LAN connection.

PIP: Picture-In-Picture

point-to-point call: A call with two participants including your self

POP: Picture Outside Picture. POP is a picture layout mode that is optimized for wide screens: Full screen, 1+3 layout and emulated dual monitor layout.

Presentation: Presentation means to show another video source. Use the Presentation Key for a predefined presentation source. Use the presentation menu to choose among all available video sources.

Presentation source: The video source that is on display when you press the Presentation Key on the remote control

Presets: Predefined camera positions (and video sources)

Q

QCIF: Quarter CIF, 176x144 pixels

QSIF: Quarter SIF, 176x120 pixels

R

Release Floor: To end the request floor function.

release floor to site: Allows the chairman to release the floor.

Remote: Short for Remote Control

Request Floor: The MCU will broadcast the video in full screen to all other participants in the conference. If the MCU conference has a chairman, a request will be sent to the the chairman.

Restart: Restarts the system.

Restore defaults: Restores system settings to the factory defaults.

Restricted call: A call to a 56 kbps network. By default the system will dial an unrestricted call (a call to a 64 kbps network) and downspeed to 56 kbps if necessary.

S

S-VHS: S-video

S-video: The standard camera uses one of the S-video inputs in the codec.

Selfview: Outgoing video. In most cases, the image of your self.

Serial number: A unique number (the hardware serial number, listed in the System Information menu) to identify your system towards your TANDBERG representatives.

Side-by-Side: Side-by-side view means that two pictures are displayed side by side each other on the screen. You will see two equally sized pictures.

SIF: Standard Input Format, 352x240 pixels

SNMP: Simple Network Management Protocol.

SNMP Community: SNMP Community names are used to authenticate SNMP requests. SNMP requests must have a password in order to receive a response from the SNMP agent in the system. The SNMP Community name is case sensitive.

SNMP Trap Host: Identifies the IP-address of the SNMP manager.

SNMP traps: Generated by the agent to inform the manager about important events.

SoftMux: Ensures high reliability and includes the unique Downspeeding feature. It also makes it possible to dial to another videoconferencing equipment, phones and mobile phones in a uniform way, and provides an on-screen, real-time feedback on the progress of a call.

Split Screen: All the participants in a MultiSite conference are displayed on the screen. (Former Continuous Presence)

Start Channel: Indicates the first E1/T1 channel the system is allowed to use. The setting might be used when if the E1/T1 line is shared with other equipment.

Start up video source: The video source that is on display when the system wakes up from standby mode.

Status Format: Provides call quality feedback on the status line.

Streaming: Allows broadcasting of audio/video via an IP network.

Streaming Address: Defined as the IP-address of a streaming client, streaming server or a multicast address.

Streaming Address Port: If several codecs are streaming to the same IP-address, different ports have to be used in order for the client to know which stream to receive.

Streaming Allow remote Start: Streaming can be started from the Videoconferencing system using the remote control, by using the Data port, or from external user interfaces like the Web-browser or Telnet session.

Streaming Announcements: The system will announce to the network that it is streaming. This enables a streaming client (e.g. a PC) to connect to the system's streaming session. Used by Cisco IP/TV.

Streaming Password: Prevents unauthorized access to the streaming functionality.

Streaming Source: Select between local video and/or far end video to be streamed. Local and far end audio is always streamed.

Streaming TTL/Router Hops: Used for streaming data to limit how many routers the data should pass before it is rejected.

Streaming Video Rate: Defines the Video streaming rate from the system.

SVGA: Super VGA. (800x600)

SXGA: Super extended Graphics Array (1280x1024)

System information: Lists system numbers, line status, software version and other useful information.

System name: Identifies a videoconferencing system

T

T1: Network type, 24 channels. Default for NTSC versions.

T1 Line Coding: Indicates how the signals on the line should be coded. If parts of the systems use restricted coding, this should be selected.

Take chair: Request chairmanship of the conference. If no one else is chairman, the request is granted.

TCS-4: Used to address different systems on a LAN when dialing in via a gateway.

Terminal Names: Lists the site numbers or name (if supported) of other sites connected in the conference.

Terminate meeting: The chairman can terminate the conference, i.e. all participants are disconnected.

TMS: TANDBERG Management Suite

Touch Tones: To dial extension numbers etc. during a call, use touch tones in order to get tones instead of preset on the number keys.

Tracker: The tracker is a small infrared remote control device made to steer the camera to any desired location within the room.

TSC-1: TCS-1 is used for H243 password on H320 MCU's

V

VCR: Video Cassette Recorder

VGA: Video Graphics Array. (640 x 480)

VGA Out Quality: Changes the resolution of the VGA signal available in the VGA Out connector at the rear of the codec.

View administrator settings: Displays all the system settings in a read only format.

View site: View any participant in the conference other than the participant currently On Air. Can be used by all conference participants.

VNC: Virtual Network Computing.

Voice Switched: The active site will be displayed in full screen during a MultiSite conference.

W

WAVE II Camera: Wide Angle View Camera - delivers the widest angle of view in the industry.

Welcome menu: The welcome menu displays the main menu when you are outside a call.

X

XGA: extended Graphics Array (1024 x 768)