



Contents

Introduction.....	1
Notational conventions	2
Important notes	2
Safety	2
Cleaning	3
Transport	3
FCC Class B Compliance Statement	3
Declaration of Conformity	4
Power cable.....	5
Energy Star Guidelines.....	5
CE marking.....	5
Disposal and recycling.....	5
Checking the contents of the consignment	6
Installing an ergonomic video workstation	7
Connecting the monitor.....	7
Tilting and turning area	9
Operation of the monitor	9
Switching the monitor on/off	10
Notes on power management	10
Changing the monitor settings	11
Notes on ergonomic colour adjustment.....	14
Technical data	15
VESA-DDC-compatible VGA interface.....	16
Supported modes	16
Pin assignment D-SUB	17
Trouble shooting.....	17





Introduction

Your new LCD (Liquid Crystal Display) monitor 43B1-M offers numerous features and functions, for example:

- TFT display (Thin Film Transistor; active matrix)
- minimal space requirements thanks to slim casing
- height adjustment and ability to turn (portrait mode)
- optimum ergonomic characteristics (totally distortion-free, excellent picture definition and colour purity right into the corners)
- high degree of brightness and good contrast
- high resolution (1280x1024) for displaying the information content of a conventional 19-inch screen with CRT (Cathode Ray Tube)
- presentation of up to 16.7 million colours (in conjunction with an appropriate graphics card)
- automatic scanning of horizontal frequencies from 30 to 80 kHz and refresh rates (vertical frequencies) from 55 to 75 Hz (all absolutely flicker-free)
- digital screen controller with microprocessor for storing 18 different display modes
- freely adjustable colour alignment for matching the screen colours to the colours of various input and output devices
- convenient operation via integrated OSD (On-Screen-Display) menu
- VESA-DDC compatibility
- VESA-FPMPMI compatibility (Flat Panel Monitor Physical Mounting Interface, mechanical interface to swivel arm and wall bracket); 75 mm hole spacing
- plug&play capability
- power management for reducing power consumption when the computer system is not in use
- compliance with the recommendations in accordance with TCO '99
- compliance with the ergonomic standards ISO 13406-2

In normal screen mode (dark characters against a light background) the monitor satisfies the ergonomic requirements for the GS symbol.

This Operating Manual contains important information you require to start up and run your LCD monitor.

A screen controller with VGA interface is required to control the 43B1-M LCD monitor. The monitor processes the data supplied to it by the screen controller. The screen controller/the associated driver software is responsible for setting the modes (resolution and refresh rate).

When putting the monitor into operation for the first time, the screen display should be optimally adapted to the screen controller used and adjusted in accordance with your needs (see the "Changing the monitor settings" section in the "Operation of the monitor" chapter).

Target group

You don't need to be an "expert" to perform the operations described here. Do, however, read the chapter "Important notes" in the Operating Manual of the computer and in this Operating Manual.

In the event of any problems occurring, please contact your sales outlet or our Help Desk.

Further information

Details of how you set the resolution and refresh rate are provided in the documentation on your screen controller/the associated driver software.





Notational conventions

The meanings of the symbols and fonts used in this manual are as follows:



Pay particular attention to text marked with this symbol. Failure to observe this warning endangers your life, destroys the device, or may lead to loss of data.



Supplementary information, remarks, and tips follow this symbol.

► Text which follows this symbol describes activities that must be performed in the order shown. "Quotation marks" indicate names of chapters or terms.

Texts in italics indicate filenames and menu items.

Important notes



In this chapter you will find information regarding safety which is essential to take note of with your monitor.

Safety

This device complies with the relevant safety regulations for data processing equipment, including electronic office machines for use in an office environment. If you have any questions, contact your sales outlet or our Help Desk.

- Use only a type "CH-1204" or "STD-1204" power adapter.
- The display surface of the LCD monitor is sensitive to pressure and scratches. You should therefore be careful with the display surface so as to avoid lasting damage (Newton rings, scratches).
- If the device is brought into the installation site from a cold environment, condensation can form. Before operating the device, wait until it is absolutely dry and has reached approximately the same temperature as the installation site.
- During installation and before operating the device, please observe the instructions on environmental conditions in the "Technical data" chapter as well as the instructions in the "Installing an ergonomic video workstation" chapter.
- To ensure sufficient ventilation, the monitor may only be operated with the monitor base, swivel arm or wall bracket.
- Ensure that the power socket on the device or the grounded mains outlet is freely accessible.
- The ON/OFF switch does not disconnect the device from the mains voltage. To completely disconnect the mains voltage, remove the power plug from the socket.
- Lay all cables so that nobody can stand on them or trip over them. When attaching the device, observe the relevant notes in the chapter "Connecting the monitor".
- No data transmission cable should be connected or disconnected during a thunderstorm.
- Make sure that no objects (e.g. jewellery chains, paper clips, etc.) or liquids get inside the device (danger of electric shock, short circuit).



- In emergencies (e.g. damaged casing, elements or cables, penetration of liquids or foreign matter), switch off the unit, disconnect the power plug and contact your sales outlet or our Help Desk.
- The screen background lighting contains mercury. You must observe the applicable handling and disposal safety regulations for fluorescent tubes.
- Only qualified technicians should repair the device. Unauthorised opening and incorrect repair may greatly endanger the user (electric shock, fire risk).
- You may set only those resolutions and refresh rates specified in the "Technical data" chapter. Otherwise you may damage your monitor. If you are in any doubt, contact your sales outlet or our Help Desk.
- Keep this operating manual together with your device. If you pass on the device to third parties, you should include this manual.

Cleaning

- Always pull out the power plug before you clean the monitor.
- Do not clean any interior parts yourself, leave this job to a service technician.
- Do not use any cleaning agents that contain abrasives or may corrode plastic.
- Ensure that no liquid will run into the system.
- Ensure that the ventilation areas of the monitor are free.
- The display surface of the LCD monitor is sensitive to pressure and scratches. Clean it only using a soft, slightly moistened cloth.

Wipe the monitor casing with a dry cloth. If the monitor is particularly dirty, use a cloth which has been moistened in mild domestic detergent and then carefully wrung out.

Transport

- Transport the monitor with care and only in its original packaging or another corresponding packaging fit to protect it against knocks and jolts.
- Never drop the LCD monitor (danger of glass breakage).

FCC Class B Compliance Statement

The following statement applies to the products covered in this manual, unless otherwise specified herein. The statement for other products will appear in the accompanying documentation.

NOTE:

This equipment has been tested and found to comply with the limits for a "Class B" digital device, pursuant to Part 15 of the FCC rules and meets all requirements of the Canadian Interference-Causing Equipment Regulations. These limits are designed to provide reasonable protection against harmful interference in a residential installation. This equipment generates, uses and can radiate radio frequency energy and, if not installed and used in strict accordance with the instructions, may cause harmful interference to radio communications. However, there is no guarantee that interference will not occur in a particular installation.



Colour monitor 43B1-M

If this equipment does cause harmful interference to radio or television reception, which can be determined by turning the equipment off and on, the user is encouraged to try to correct the interference by one or more of the following measures:

- Reorient or relocate the receiving antenna.
- Increase the separation between equipment and the receiver.
- Connect the equipment into an outlet on a circuit different from that to which the receiver is connected.
- Consult the dealer or an experienced radio/TV technician for help.

Fujitsu Siemens Computers GmbH is not responsible for any radio or television interference caused by unauthorized modifications of this equipment or the substitution or attachment of connecting cables and equipment other than those specified by Fujitsu Siemens Computers GmbH. The correction of interference caused by such unauthorized modification, substitution or attachment will be the responsibility of the user.

The use of shielded I/O cables is required when connecting this equipment to any and all optional peripheral or host devices. Failure to do so may violate FCC rules.

Declaration of Conformity

This device complies with Part 15 of the FCC Rules. Operation is subject to the following two conditions: (1) this device may not cause harmful interference, and (2) this device must accept any interference received, including interference that may cause undesired operation.

Product name:	Colour LCD Monitor
Trade name:	Fujitsu Siemens Computers Inc.
Model number(s):	43B1-M
Name of responsible party:	Siemens Information and Communication Products LLC 3860 N. First Street San Jose, CA 95134-1702 U.S.A.
Contact person:	Schroettle-Henning, Bernd
Phone No.:	(408) 571-6051
Fax No.:	(408) 571-6196

We, Siemens Information and Communication Products LLC, hereby declare that the equipment bearing the trade name and model number specified above was tested confirming to the applicable FCC Rules under the most accurate measurement standards possible, and that all the necessary steps have been taken and are in force to assure that production units of the same equipment will continue to comply with the Commissions requirements.



Power cable

To guarantee safe operation, use the cable supplied. Use the following guidelines if it is necessary to replace the original cable set.

- The female/male receptacles of the cord set must meet CEE-22 requirements.
- The cable has to be HAR-certified or VDE-certified. The mark HAR or VDE will appear on the outer sheath or on the insulation of one of the inner conductors.
- For devices which are mounted on a desk or table, type SVT or SJT cable sets may be used. For devices which sit on the floor, only SJT type cable sets may be used.
- The cable set must be selected according to the rated current for your device.

Energy Star Guidelines



The Fujitsu Siemens LCD colour monitor 43B1-M is designed to conserve electricity by dropping to less than 3 W when it goes into standby, suspend and OFF mode. With this new power management the 43B1-M qualifies for the U.S. Environmental Protection Agency's (EPA) Energy Star Computers award.

The EPA estimates that computer equipment uses 5% percent of all business electricity and that this is growing rapidly. If all desktop computers and peripherals enter a low-power mode when not in use, the overall savings in electricity could amount to \$ 2 thousand million annually. These savings could also prevent the emission of 20 million tons of carbon dioxide into the atmosphere - the equivalent of 5 million automobiles.

As an Energy Star Partner, Fujitsu Siemens Computers GmbH has determined that this product meets the Energy Star guidelines for energy efficiency.

CE marking



The shipped version of this device complies with the requirements of the EEC directives 89/336/EEC "Electromagnetic compatibility" and 73/23/EEC "Low voltage directive".

Disposal and recycling

This device has been manufactured to the highest possible degree from materials which can be recycled or disposed of in a manner that is not environmentally damaging. The device may be taken back after use to be recycled, provided that it is returned in a condition that is the result of normal use. Any components not reclaimed will be disposed of in an environmentally acceptable manner.

If you have any questions on disposal, please contact your local office, our Help Desk, or:

Fujitsu Siemens Computers GmbH
Recyclingcenter
D-33106 Paderborn
Tel.: +49 5251 / 81 80 10, Fax: +49 5251 / 81 80 15



Checking the contents of the consignment

- ▶ Unpack all the individual parts.
- ▶ Check the delivery for damage incurred during transportation.
- ▶ Check whether the delivery agrees with the details in the delivery note.
The complete LCD monitor package includes:
 - a monitor with permanently connected data cable
 - a power adapter with power adapter cable
 - one power cable
 - one floppy disk
 - one Warranty Booklet
 - this Operating Manual

Should you discover that the delivery does not correspond to the delivery note, notify your local sales outlet immediately.



It is recommended not to throw away the original packaging material. Keep it for future transportation.



Installing an ergonomic video workstation

Before you set up your equipment, you should select a suitable position for working at the monitor. Please observe the following advice when installing a video workstation.

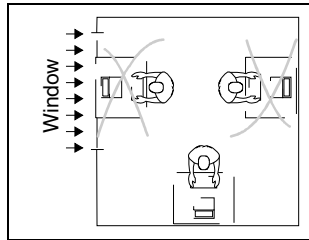

Avoid direct and reflected glare.

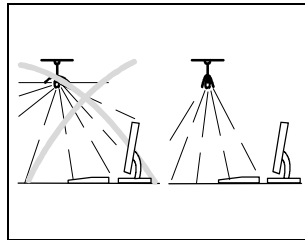

Avoid glare from electric lighting.

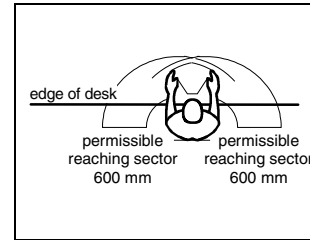

Position the keyboard where it is easiest to reach.

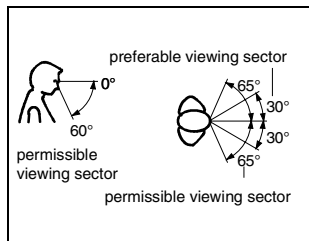

Position the monitor for optimum viewing. The viewing distance to the monitor should be approximately 50 cm.

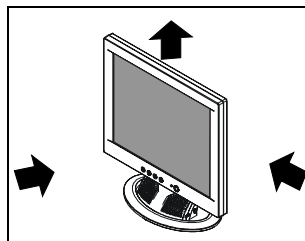

Keep ventilated areas clear.

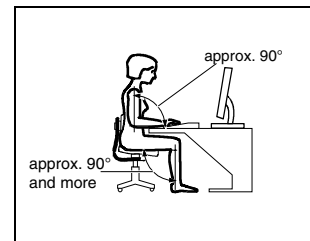

Remember to maintain correct posture.

Connecting the monitor

Information on the computer connections and interfaces is contained in the operating manual for your computer.



Observe the "Safety" in the chapter "Important notes" in this operating manual.
Do not cover the ventilation openings of the monitor.

Colour monitor 43B1-M

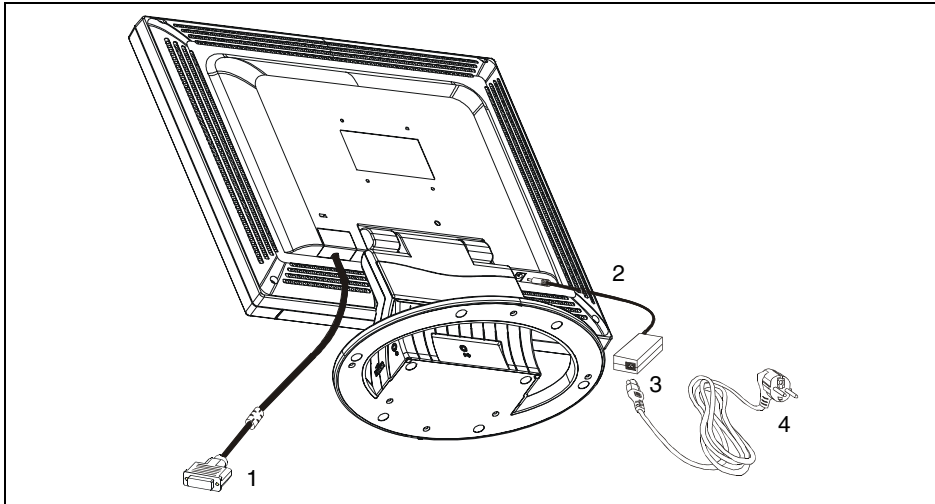

- ▶ Be sure that the monitor and the computer are switched off.



The computer power plug must be pulled out!

The permanently connected data cable is equipped with a 15-pin D-SUB plug for connection to the computer.

- ▶ Connect the connector of the data cable to the active monitor port on the computer and secure the plug-in connection by tightening the safety screws (1).



If your computer has two monitor ports ("onboard" screen controller and separate graphics card), the monitor port for the separate graphics card is usually active.

- ▶ Connect the power adapter cable of the power adapter firmly to the power connector of the monitor (2) and check whether the socket is securely seated.
- ▶ Connect the power cable to the power adapter (3).
- ▶ Connect the plug on the power cable supplied to the monitor socket of the computer (4).
- ▶ Plug the power connector of the computer into a properly grounded mains outlet.



When you start working with your monitor for the first time you should install the appropriate graphics drivers for your application software. Details of how to do this are provided in the documentation on your screen controller/the associated driver software.

Tilting and turning area

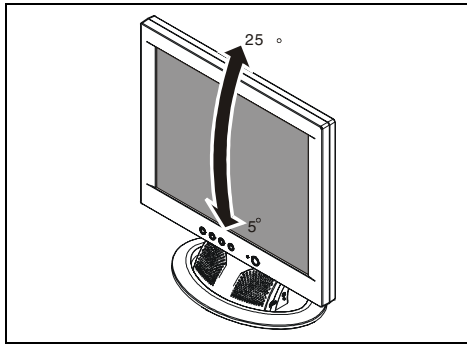

The typical monitor base allows you to adjust the tilt of the display by 5° forward and by 25° back.

Operation of the monitor

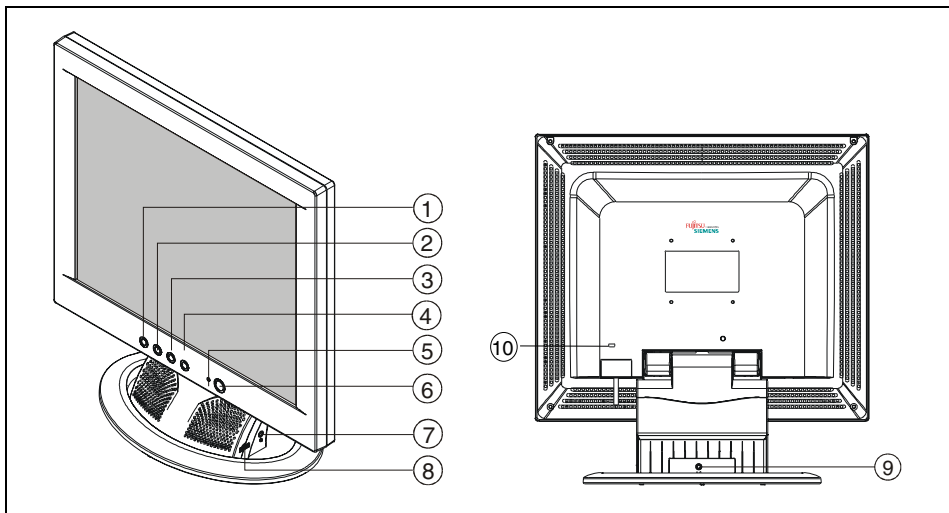

- 1 = AUTO button
- 2 = Brightness
- 3 = Contrast
- 4 = MENU button
- 5 = Power indicator

- 6 = Power button
- 7 = Headphones port
- 8 = Volume control
- 9 = Audio input
- 10 = Security slots for Kensington Lock

Anti-theft protection

A lock (Kensington Lock) can be mounted in the security slots (10) to protect the monitor from theft. A Kensington Lock is not included in the consignment of the monitor.

Switching the monitor on/off

The ON/OFF switch (6) is used for switching the monitor on and off.

The power indicator (5) glows green when the monitor and computer are switched on. The power indicator glows amber when the monitor does not receive a video signal or is in the energy-saving mode. The power indicator goes off when the monitor is switched off.

When you switch the computer system on, you must proceed in the following order:

- ▶ First switch the LCD monitor on with the ON/OFF switch (6).
- ▶ Then switch on the computer.



If your computer has a power management function (energy-saving mode), you should read the "Notes on power management" of the monitor in this chapter.

Notes on power management

If your computer is equipped with power management, the monitor can support this function fully. Here the monitor does not distinguish between the individual energy-saving modes of the computer (standby mode, suspend mode and OFF mode), as it is capable of immediately switching into the mode with the highest energy-saving effect.

Stage	ON	Energy-saving mode
Power indicator	lights green	glows amber
Function	Monitor operating normally	Monitor is dark
Power consumption	normal < 42 W	reduced to < 3 W

If your computer detects inactivity (no input) it sends an appropriate signal to the monitor to reduce the power consumption (energy-saving mode). The power indicator of the monitor changes colour to indicate the status change.

Once an input is made at the computer the screen contents are redrawn and full power is restored.

For detailed information on how energy-saving mode operates refer to the Operating Manual or Technical Manual of the computer.



When the monitor is switched to the energy-saving mode by the power management system a power consumption of up to 3 W is maintained to feed the circuit for redrawing the screen contents.

To completely switch off the power consumption, switch off the computer or pull the plug of the monitor power cable out of the monitor socket of the computer or of the mains outlet.

Changing the monitor settings

When putting the monitor into operation for the first time, the screen display should be optimally adapted to the screen controller used and adjusted in accordance with your needs.

Basic monitor adjustment with a test pattern

If one of the operating systems Windows for Workgroups, Windows 95/98, Windows NT, Windows Me, Windows 2000 or OS/2 (with Windows emulation installed) is used, the basic monitor settings can be set with the floppy disk supplied.

- ▶ Insert the supplied floppy disk into the floppy disk drive.
- ▶ Run the file *LCDADJ.EXE* on the floppy disk and press the AUTO button after the test pattern appears on the screen to start the automatic picture calibration.

Your monitor should now already be properly adjusted. If none of the above operating systems is used or minor corrections are to be made to the screen display, then change the monitor settings with the OSD menu (*Focus* and *Clock* functions).

Monitor settings with the buttons of the control panel

With the buttons of the control panel, you can make the following settings directly: auto-adjustment of the monitor, adjusting the brightness and adjusting the contrast.



Other settings are carried out via an integrated OSD menu (On-Screen Display). For additional information on this subject, refer to the section "Monitor settings using the OSD menu".

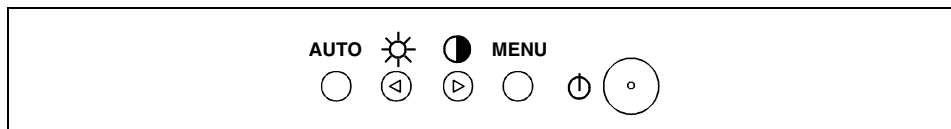

Proceed as follows:

Performing auto-adjustment of the monitor

- ▶ Press the AUTO button for roughly one second to start the auto adjustment function. Clock, focus and position are set to optimum values for your system.

Adjusting the brightness

- ▶ Press the ◀ button to activate the setting window for brightness (*Brightness*).
- ▶ Set the brightness with the ◀ or ▶ buttons, until the picture appears correct.
- ▶ Press the MENU button to save the settings and to switch the OSD menu off. If you make no changes for 60 seconds, the settings will automatically be saved and the OSD menu will be deactivated.

Adjusting the contrast

- ▶ Press the **▶** button to activate the setting window for contrast (*Contrast*).
- ▶ Set the contrast with the **◀** or **▶** buttons, until the picture appears correct.
- ▶ Press the **AUTO** button to save the settings and to switch the OSD menu off. If you make no changes for 60 seconds, the settings will automatically be saved and the OSD menu will be deactivated.

Monitor settings using the OSD menu

You can use the buttons on the control panel to set the screen display via an integrated OSD menu (On-Screen-Display).

 The OSD menu is available in five languages (default setting: English). With the OSD function *Language* you can select another language.

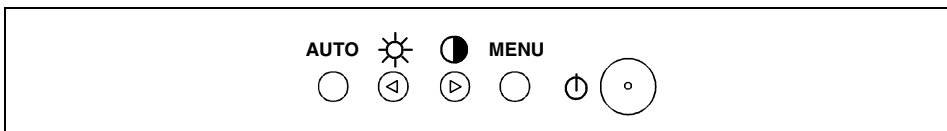

To set the OSD menu, perform the following steps:

- ▶ Press the **MENU** button to activate the OSD menu.

The main menu appears on the screen with icons for the setting functions.

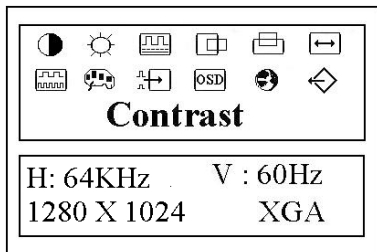

The first symbol (*Contrast*) is highlighted.











If you want to change the contrast:

- ▶ Press the **MENU** button and make the desired setting with the **◀** or **▶** button.
- ▶ Press the **MENU** button to return to the main menu.

If you want to change another setting:

- ▶ Use the **◀** or **▶** button to mark another icon in the main menu, e.g. *H.Position*.
- ▶ Press the **MENU** button and make the desired setting with the **◀** or **▶** button.
- ▶ Briefly press the **AUTO** button to save the settings and to switch the OSD menu off. If you make no changes for 60 seconds, the settings will automatically be saved and the OSD menu will be deactivated.

If you want to change other settings, select the corresponding function from the main menu. All possible adjustments of the monitor are described in the following.

	<p>Setting the contrast of the display (<i>Contrast</i>)</p> <p>If the contrast is set too high, bright grey levels can no longer be distinguished from very bright grey levels. If the contrast is set too low, the maximum brightness will not be achieved.</p>
	<p>Setting the brightness of the display (<i>Brightness</i>)</p>
	<p>Setting the <i>Black level</i></p> <p>With the black level you adjust the brightness of the gray-scale values. Resetting the monitor to the factory settings adjusts the black level to the optimal value.</p> <p>If the black level is set too high, black surfaces are no longer shown as deep black, but instead as gray (worse contrast). If the black value is too low, it is not possible to distinguish between dark shades.</p>
	<p>Setting the focus (picture definition) (<i>Focus</i>)</p> <p>Eliminate picture noise and improve focus.</p>
	<p>Setting the clock (picture width) (<i>Clock</i>)</p> <p>Eliminate vertical interference with local fuzziness (synchronisation with the graphic card signals).</p> <p>There is only one proper setting per resolution and refresh rate for these parameters.</p>
	<p>Adjusting the horizontal position (<i>H. Position</i>)</p> <p>Shifting the picture to the left or to the right.</p>
	<p>Adjusting the vertical position (<i>V. Position</i>)</p> <p>Shifting the picture up or down.</p>
	<p>Setting language for the OSD menu (<i>Language</i>)</p> <p>You can choose from English (default setting), German, French, Spanish and Italian.</p>
	<p>Setting the colour temperature</p> <p>Setting colour tone of screen to 9300°K (bluish) or 7300°K (less bluish) or to a user-defined colour temperature.</p>
	<p>Resetting the monitor to the factory settings (<i>Reset</i>)</p>
	<p>Executing <i>AUTO LEVEL</i> function</p> <p><i>AUTO LEVEL</i> adjusts contrast (video gain) to optimal value and returns contrast numerical feedback value in the OSD to 50.</p>



Locking the OSD menu (OSD Lock)

The OSD menu can be locked to prevent accidental or unauthorised changes to the monitor settings.

- ▶ Switch your monitor off.
- ▶ Press and hold down the ◀ and ▶ buttons and switch on the monitor simultaneously.

The OSD menu is locked.

If you press the MENU button and the OSD menu is locked, the message *OSD locked* appears on the screen.

After OSD is locked brightness and contrast shortcuts and *AUTO LEVEL* function are still available.

Please proceed in the same manner to release the locked OSD menu again.

Notes on ergonomic colour adjustment

If you select colours for the display in your application programmes, take note of the information below.

The primary colours blue and red on a dark background do not produce the minimum required contrast of 3:1 and are therefore not suitable for continuous text and data entry.

When using several colours for characters and background and giving the primary colours full modulation, you can obtain very suitable colour combinations (see the following table):

Background	Characters							
	black	white	purple	blue	cyan	green	yellow	red
black		+	+	-	+	+	+	-
white	+		+	+	-	-	-	+
purple	+	+		-	-	-	-	-
blue	-	+	-		+	-	+	-
cyan	+	-	-	+		-	-	-
green	+	-	-	+	-		-	-
yellow	+	-	+	+	-	-		+
red	-	+	-	-	-	-	+	

- + Colour combination very suitable
- Colour combination not suitable because colour locations are too close together, thin characters are not identifiable or rigorous focusing is demanded of the human eye.



Technical data

Dimensions and weight (LCD monitor)

Visible diagonals:	43,2 cm
Dot pitch:	0,264 mm
Screen size:	339,70 mm x 272,10 mm
Maximal resolution:	1280x1024 pixel
Luminance:	250 cd/m ² (typical)
Dimensions (W x H x D) incl. monitor base:	407 mm x 427 mm x 195 mm
Turning area:	5° forward, 25° back
Weight:	approx. 5.5 kg
Accessories:	Power cable (1.8 m), power adapter, audio cable

Storable display modes: 18

Electrical data

Rated mains voltage:	100 V - 240 V (± 10 %)
Frequency:	50 Hz - 60 Hz (± 3 Hz)
Video:	analogue, positive, 0.7 V _{pp} , 75 Ω
Synchronisation:	Separate Sync. TTL, positive or negative
Horizontal frequency:	30 kHz 80 kHz (multi-scanning)
Refresh rate:	55 Hz 75 Hz
Maximum pixel rate:	135 MHz
Total power consumption	< 42 W (ON, Normal mode) < 3 W in the energy-saving mode (standby mode, suspend mode and OFF mode)
Audio:	2 x 1 W

Environmental conditions

Environment class 3K2, IEC 721	
Rated range of operation:	15 °C 35 °C
Humidity:	20 % 85 %
Limit range of operation:	5 °C 35 °C
Humidity:	20 % 85 %

Condensation must be avoided.

VESA-DDC-compatible VGA interface

Your monitor is equipped with a VESA-DDC-compatible VGA interface. VESA-DDC (Video Electronics Standard Association, Display Data Channel) is used as the communications interface between the monitor and the computer. If your computer is equipped with a VESA-DDC-compatible VGA interface, it can automatically read the data for ensuring optimum operation from your monitor and select the appropriate settings.



If the monitor 43B1-M is not yet displayed in the list of monitors, you can select the following monitor instead:

C383 FA or 3814 FA

Supported modes



The display position and scanning are set to optimum values automatically for the operating modes listed below. Depending on the screen controller used, it may be necessary to adjust the display position and scanning. In this case, you can change and save the settings (see "Operation of the monitor").

Screen resolution	Refresh rate	Horizontal frequency
720 x 400	70 Hz	31.47 kHz
640 x 480	60 Hz	31.47 kHz
640 x 480	66.6 Hz	35.00 kHz
640 x 480	75 Hz	37.50 kHz
800 x 600	60 Hz	37.88 kHz
800 x 600	75 Hz	46.88 kHz
832 x 624	75 Hz	49.73 kHz
1024 x 768	60 Hz	48.36 kHz
1024 x 768	70 Hz	56.48 kHz
1024 x 768	75 Hz	60.02 kHz
1024 x 768	74.9 Hz	60.24 kHz
1280 x 1024	60 Hz	63.98 kHz
1280 x 1024	75 Hz	79.98 kHz

For ergonomic reasons, a screen resolution of 1280 x 1024 pixels is recommended. Because of the technology used (active matrix) an LCD monitor provides a totally flicker-free picture even with a refresh rate of 60 Hz.



From a technical point of view, it is preferable to set a refresh rate of above 60 Hz on an LCD monitor with a TFT display.

Pin assignment D-SUB

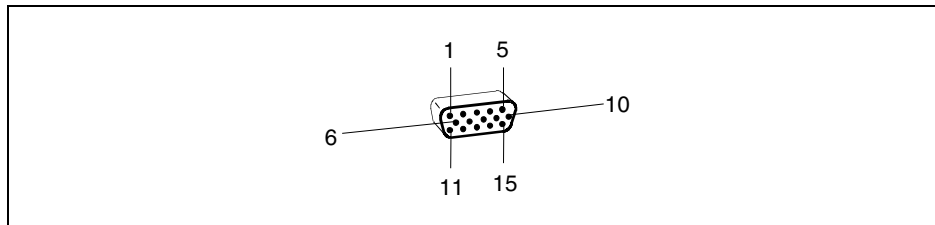

Pin	Meaning
1	Video input red
2	Video input green
3	Video input blue
4	Ground
5	DDC ground
6	Red video ground
7	Green video ground
8	Blue video ground

Pin	Meaning
9	+5 V for DDC
10	Sync. ground
11	Ground
12	DDC-Data
13	H. sync
14	V. sync
15	DDC Clock

Trouble shooting

Should an error occur, first check the following points. If the distortion is still not eliminated, the monitor should, if possible, be checked on another computer.

If you are unable to solve the problem, please inform our Help Desk.

The display is too small or not centred

The monitor recognises an undefined mode (see "Technical data").

- ▶ Adjust the position and the size of the display and save your settings (see "Operation of the monitor").

No display (power indicator does not light)

- ▶ Check whether the monitor is switched on.
- ▶ Check whether the power cable is connected correctly on the monitor and on the computer.
- ▶ Check whether the mains socket is live.



Colour monitor 43B1-M

No display (power indicator lights)

- ▶ Check whether the computer is switched on.
- ▶ Check whether the data cable for the monitor is correctly attached to the monitor port on the computer.
- ▶ Press any key on the computer keyboard – the computer may be in energy saving mode.
- ▶ Alter the brightness and/or contrast until you get a picture.

Picture disturbances (vertical and horizontal lines, picture noise)

- ▶ Perform auto-adjustment.



If one of the operating systems Windows for Workgroups, Windows 95/98, Windows NT, Windows Me, Windows 2000 or OS/2 (with Windows emulation installed) is used, the basic monitor settings can be set with the floppy disk supplied.

Detailed information is contained in the section "Basic screen adjustment with a test pattern".

Permanently unlit or lit pixels

The standard of production techniques today cannot guarantee an absolutely fault-free monitor. A few isolated constant lit or unlit pixels may be present. The maximum permitted number of pixels faults is stipulated in the stringent international standard ISO 13406-2 (Class II).

Example: a 17" flat-screen monitor with a resolution of 1280 x 1024 has $1280 \times 1024 = 1310720$ pixels. Each pixel consists of three subpixels (red, green and blue), so there are about 4 million dots in total.

According to ISO 13406-2 (Class II), a maximum of 6 pixels and 7 subpixels may be defective, i. e. a total of 25 faulted dots. This corresponds to approx. 0,00062% of the entire screen surface!

The flat screen monitors from Fujitsu Siemens Computers are typically considerably better than requirements defined in this standard.

The screen becomes darker

The background lighting has a limited lifetime. If your monitor display should become too dark, the background lighting will have to be exchanged. Please contact our Help Desk.

Image of last screen display still visible

If you switch from a high-contrast display (for example black lines/characters on a white background) to a picture of medium brightness, you may be able to see a faint image of the previous display for a time. This phenomenon is not due to a monitor defect but to the technology used.

