

LCD TV Monitor

User Manual

The colour and the appearance may differ depending on the product, and the specifications are subject to change without prior notice to improve the performance.



Table Of Contents

MAJOR SAFETY PRECAUTIONS

| | |
|----------------------------|-----|
| Before You Start | 1-1 |
| Care and Maintenance | 1-2 |
| Safety Precautions | 1-3 |

INSTALLING THE PRODUCT

| | |
|--|------|
| Package Contents | 2-1 |
| Installing the Stand | 2-2 |
| Removing the Stand | 2-3 |
| Attaching a Wall Mount/Desktop Stand | 2-4 |
| Connecting to a Computer | 2-5 |
| Using it as a TV | 2-6 |
| Connecting an HDMI cable | 2-7 |
| Connecting Using a DVI to HDMI Cable | 2-8 |
| Connecting a Component cable | 2-9 |
| Connecting a Scart cable | 2-10 |
| Connecting COMMON INTERFACE | 2-11 |
| Connecting to an Amplifier | 2-12 |
| Connecting Headphones | 2-13 |
| Kensington Lock | 2-14 |

USING THE PRODUCT

| | |
|--|-----|
| Plug & Play Feature | 3-1 |
| Viewing the Control panel | 3-2 |
| Remote Control | 3-3 |
| Teletext Feature | 3-4 |
| Using the Screen Adjustment Menu (OSD: On Screen Display) | 3-5 |
| Installing the Device Driver | 3-6 |
| Standard Signal Mode Table | 3-7 |

INSTALLING THE SOFTWARE

| | |
|---------------------|-----|
| Natural Color | 4-1 |
| MultiScreen | 4-2 |

TROUBLESHOOTING

| | |
|---------------------------------|-----|
| Monitor Self-Diagnosis | 5-1 |
| Before Requesting Service | 5-2 |
| FAQ | 5-3 |



MORE INFORMATION

| | |
|---------------------------------|-----|
| Specifications | 6-1 |
| Power Saving Function | 6-2 |
| Contact SAMSUNG WORLDWIDE | 6-3 |
| Correct Disposal | 6-4 |

1 Major Safety Precautions

1-1 Before You Start

Icons used in this manual

| ICON | NAME | MEANING |
|---|---------|---|
|  | Caution | Indicates cases where the function may not work or the setting may be canceled. |
|  | Note | Indicates a hint or tip to operate a function. |

Using this Manual

- Make yourself fully aware of the safety precautions before using this product.
- If a problem occurs, refer to the 'Troubleshooting' section.

Copyright Notice

The contents of this manual are subject to change without prior notice for performance improvement.

Copyright © 2010 Samsung Electronics Co., Ltd. All Rights Reserved.

The copyright of this manual is reserved by Samsung Electronics, Co., Ltd.

The contents of this manual may not be partially or in whole reproduced, distributed or used in any form without the written permission of Samsung Electronics, Co., Ltd.

The SAMSUNG logo and SyncMaster are the registered trademarks of Samsung Electronics, Co., Ltd.

Microsoft, Windows and Windows NT are the registered trademarks of Microsoft Corporation.

VESA, DPM and DDC are the registered trademarks of the Video Electronics Standard Association.

The ENERGY STAR logo is the registered trademark of the U.S. Environmental Protection Agency.

All other trademarks mentioned herein belong to their respective companies.



TruSurround HD, SRS and  symbol are trademarks of SRS Labs, Inc.
TruSurround HD technology is incorporated under licence from SRS Labs, Inc.



Manufactured under licence from Dolby Laboratories. Dolby and the double-D symbol are trademarks of Dolby Laboratories.

1-2 Care and Maintenance

External Surface and Screen Maintenance

Clean the product with a soft dry cloth.

- Avoid cleaning the product with an inflammable substance such as benzene or thinner or with a wet cloth. This may result in a problem with the product.
- Avoid scratching the screen with your fingernails or a sharp object.
- Avoid cleaning the product by spraying water onto it. If water enters the product, it may result in fire, electric shock or a problem with the product.

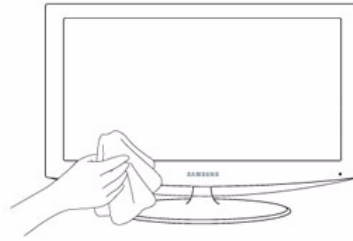

A white stain may be generated on the surface of the model if a supersonic humidifier is used near it.

- 📌 The appearance and the colour may differ depending on models.

Securing the Installation Space

- Keep the required distances between the product and other objects (e.g. walls) to ensure proper ventilation. Failing to do so may result in fire or a problem with the product due to an increase in the internal temperature. Install the product so the required distances shown in the figure are kept.

- 📌 The appearance may differ depending on the product.

When installing the product with a stand

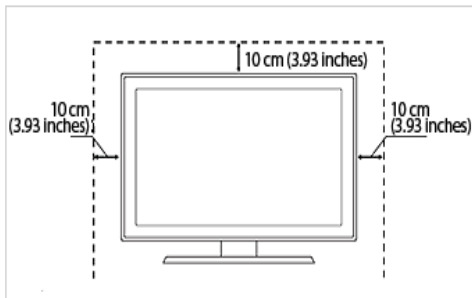

When installing the product with a wall-mount

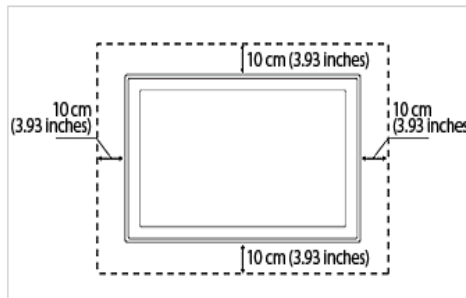

About persistent images

- Displaying a still image for a long time may create a persistent image or stain on the screen. If you do not use the product for a long time, set the power-saving mode or screen saver.
- Due to technological constraints of the LCD Panel manufacturer, the images generated by this product may appear either brighter or darker than normal by appr. 1ppm (parts per million) pixel.
The number of sub-pixels of an LCD panel by size: The number of Sub-Pixels = Max. Horizontal Resolution x Max. Vertical Resolution x 3

1-3 Safety Precautions

Icons used for safety precautions

| ICON | NAME | MEANING |
|------|---------|---|
| | Warning | Failing to follow the precautions marked with this sign may result in a serious injury or even a fatality. |
| | Caution | Failing to follow the precautions marked with this sign may result in a personal injury or property damage. |

Meaning of Signs



Do not perform.



Must be followed.



Do not disassemble.



The power plug must be unplugged from the wall outlet.



Do not touch.



Must be grounded to prevent electric shock.

Power Related

The following images are for your reference and may differ depending on models and countries.

Warning

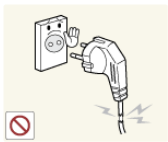

Avoid using a damaged power cord or plug or a loose power outlet.

- Otherwise, it may result in electric shock or fire.



Avoid connecting multiple electric appliances to a single wall outlet.

- Otherwise, it may result in fire due to overheating of the wall outlet.



Avoid plugging in or unplugging the power supply with wet hands.

- Otherwise, it may result in electric shock.

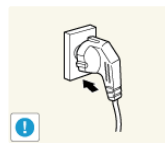

Plug the power plug in firmly.

- Otherwise, it may result in fire.

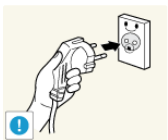

Make sure to connect the power cord to a grounded wall outlet (for insulation class 1 equipment only).

- Otherwise, it may result in electric shock or injury.



Avoid bending or twisting the power cord excessively and avoid placing heavy objects on the cord.

- Otherwise, it may result in electric shock or fire due to a damaged power cord.

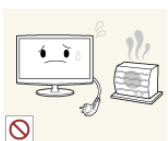

Keep the power cord and the product away from a heater.

- Otherwise, it may result in electric shock or fire.



If the pins of the power plug or the wall outlet are covered in dust, clean it using a dry cloth.

- Otherwise, it may result in fire.

Caution



Avoid unplugging the power plug while the product is operating.

- Otherwise, it may damage the product due to electric shock.

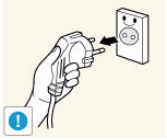

When unplugging the power plug from the wall outlet, make sure to hold it by the plug and not by the cord.

- Otherwise, it may result in electric shock or fire.

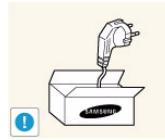

Make sure to use only the power cord supplied by our company. In addition, do not use the power cord of another electric appliance.

- Otherwise, it may result in electric shock or fire.



Connect the power plug to a wall outlet that can be easily reached.

- When a problem occurs with the product, you must unplug the power plug to cut the power off completely. You cannot cut the power off completely using only the power button on the product.

Installation Related

Warning



Avoid placing burning candles, mosquito-repellent or cigarettes on the product.

- Otherwise, it may result in fire.

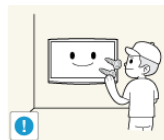

Ask an installation engineer or relevant company to install the product onto the wall.

- Otherwise, it may result in injury.
- Make sure to use the specified wall mount.



Avoid installing the product in a badly-ventilated location such as inside a bookshelf or closet.

- Otherwise, it may result in fire due to internal over-heating.

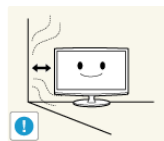

Keep a distance of at least 10 cm (3.93 inches) from the wall when installing the product for ventilation.

- Otherwise, it may result in fire due to internal over-heating.

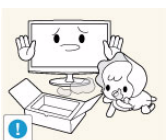

Keep the plastic bags used to pack the product away from children.

- If children place the plastic bags over their heads, they may suffocate.



Avoid installing the product in a location that is unstable or exposed to excessive vibration such as on an unstable or slanted shelf.

- The product may fall and this may result in damage to the product or injury.
- If you use the product in a location exposed to excessive vibrations, it may result in a problem with the product or fire.



Avoid installing the product in a location exposed to dust, moisture (sauna), oil, smoke or water (rain drops) and installing it within a vehicle.

- This may result in electric shock or fire.

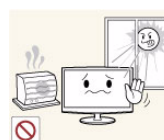

Avoid installing the product in a location exposed to direct sunlight and installing the product near a heat source such as a fireplace or heater.

- This may shorten the product life cycle or cause fire.



Avoid installing the product where children may reach it.

- If a child touches the product, the product may fall and this may result in injury.
- Since the front part is heavier, install the product on a flat and stable surface.

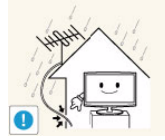

Bend the outdoor antenna cable downwards at the location where it comes in the house so that rainwater does not flow in.

- If rainwater enters the product, it may result in electric shock or fire.



Install the antenna far away from any high voltage cables.

- If the antenna touches or falls onto a high voltage cable, it may result in electric shock or fire.

Caution



Do not let the product drop while moving it.

- This may result in a problem with the product or injury.



Do not place the product face down on the floor.

- This may damage the panel of the product.



When installing the product on a console or shelf, make sure that the front of the product does not protrude out of the console or shelf.

- Otherwise, this may cause the product to fall off and result in a malfunction or injury.
- Make sure to use a cabinet or shelf suitable to the size of the product.



When putting the product down, handle it gently.

- Otherwise, it may result in a problem with the product or injury.



If the product is installed in a location where the operating conditions vary considerably, a serious quality problem may occur due to the surrounding environment. In this case, install the product only after consulting one of our service engineers about the matter.

- Places exposed to microscopic dust, chemicals, too high or low temperature, high humidity, airports or stations where the product is continuously used.

Cleaning Related

Warning



Before cleaning the product, unplug the power cord.

- Otherwise, it may result in electric shock or fire.

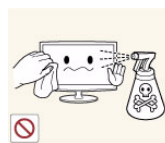

When cleaning the product, do not spray water directly over the product parts.

- Make sure that water does not enter the product.
- Otherwise, it may result in fire, electric shock or a problem with the product.

Caution



Avoid spraying cleansing agent directly onto the product.

- This may result in discoloration or cracking of the exterior of the product or the panel coming off.



When cleaning the product, disconnect the power cord and clean the product with the supplied cleaning cloth.

- Avoid using chemicals such as wax, benzene, alcohol, thinner, mosquito-repellent, fragrance, lubrication or cleansing agent when cleaning the product.

This may result in the exterior being deformed or the print being removed.

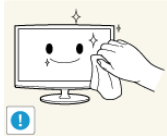

If you can't get the product clean with just the supplied cloth, use a soft, damp cloth with a "monitor-exclusive cleansing agent" and wipe the product with it.

- If no monitor-exclusive cleansing agent is available, dilute a cleansing agent with water at a ratio of 1:10 before cleaning the product.



Since the exterior of the product is easily scratched, be sure to use the supplied cleansing cloth.

Usage Related

Warning



Since a high voltage runs through the product, never disassemble, repair or modify the product yourself.

- Otherwise, it may result in fire or electric shock.
- If the product needs to be fixed, contact a service centre.



To move the product, turn the power off and unplug the power cord, the antenna cable and any other wires connected to the product.

- Otherwise, it may result in electric shock or fire due to the damaged power cord.



If the product generates a strange noise, a burning smell, or smoke, unplug the power plug immediately and contact a service centre.

- Otherwise, it may result in electric shock or fire.



Avoid letting children hang or climb onto the product.

- Otherwise, it may result in the product falling and this may result in injury or death.



If you drop the product or the case is damaged, turn the power off and unplug the power cord. Contact a service centre.

- Otherwise, it may result in fire or electric shock.



Avoid placing objects such as toys and cookies on top of the product.

- If a child hangs over the product to grab an object, the object or the product may fall and this may result in injury or even death.

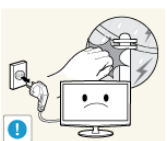

When thunder or lightning occurs, unplug the power cord and under no circumstance touch the antenna cable as this is dangerous.

- Otherwise, it may result in electric shock or fire.



Avoid dropping an object over the product or cause impact to the product.

- Otherwise, it may result in electric shock or fire.



Avoid moving the product by pulling the power cord or antenna cable.

- Otherwise, it may result in electric shock, fire or a problem with the product due to damage to the cable.



When a gas leak occurs, do not touch the product or the power plug and ventilate immediately.

- A spark may result in an explosion or fire.
- During a thunder or lighting storm, do not touch the power cord or antenna cable.

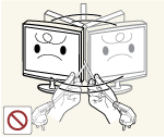

Avoid lifting up or moving the product by holding only the power cord or signal cable.

- Otherwise, it may result in electric shock, fire or a problem with the product due to damage to the cable.



Avoid using or placing inflammable spray or objects near the product.

- This may result in an explosion or fire.



Take care not to block the vent by a table cloth or curtain.

- Otherwise, it may result in fire due to internal overheating.



Avoid inserting metal objects such as a chopsticks, coins or hairpins, or inflammable objects into the product (the vents, ports, etc).

- If water or substances enters the product, turn the power off, unplug the power cord and contact a service centre.
- Otherwise, it may result in a problem with the product, electric shock or fire.



Avoid placing a liquid container such as a vase, flowerpot, beverage, cosmetics or drugs, or a metal object over the product.

- If water or substances enter the product, turn the power off, unplug the power cord and contact a service centre.
- Otherwise, it may result in a problem with the product, electric shock or fire.

Caution



Displaying a still image for a long time may create a persistent image or stain on the screen.

- If you do not use the product for a long time, use the power-saving mode or set the screensaver to the moving picture mode.

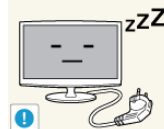

When not using the product for a long time such as leaving your home, unplug the power cord from the wall outlet.

- Otherwise, it may cause dust accumulation and result in fire caused by overheating or short circuit or result in an electric shock.



Set the appropriate resolution and frequency for the product.

- Otherwise, it may result in eye strain.



Avoid turning the product upside down or move the product holding only the stand.

- This may cause the product to fall, resulting in damage to the product or injury.



Watching the product from too close a distance continuously may damage your eyesight.



Avoid using a humidifier or cooker near the product.

- Otherwise, it may result in electric shock or fire.

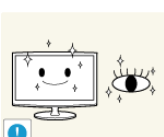

It is important to give your eyes some rest (5 minutes every hour) when viewing the product screen for long periods of time.

- This will alleviate any eye strain.



Since the display panel is hot after using it for a long time, do not touch the product.

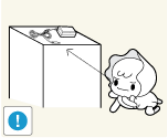

Keep the small accessories in a location out of the reach of children.



Take care when adjusting the angle of the product or the height of the stand.

- If your hand or finger is caught, you may be injured.
- If the product is tilted excessively, the product may fall and this may result in injury.



Avoid placing a heavy object over the product.

- Otherwise, it may result in a problem with the product or injury.



When using headphones or earphones, do not turn the volume too high.

- Having the sound too loud may damage your hearing.



Be careful that children do not place the batteries in their mouths when removed from the remote control. Place the battery in a location that children or infants cannot reach.

- If children have had the battery in their mouths, consult your doctor immediately.

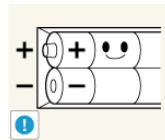

When replacing the batteries, insert them with right polarity (+, -).

- Otherwise, the battery may become damaged or it may cause fire, personal injury or damage due to leakage of the internal liquid.

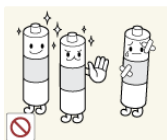

Use only specified standard batteries. Do not use new and used batteries together.

- This may cause a battery to break or leak and may cause fire, injury, or contamination (damage).

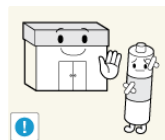

The batteries (and rechargeable batteries) are not ordinary refuse and must be returned for recycling purposes. The customer is responsible for returning the used or rechargeable batteries for recycling.

- The customer can return used or rechargeable batteries to a nearby public recycling centre or to a store selling the same type of the battery or rechargeable battery.

Maintaining the Correct Posture when Using this Product

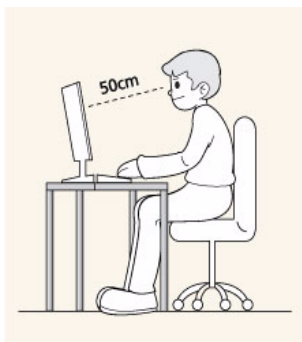















Maintain the correct posture when using this product.

- Straighten your back.
- Keep a distance of 45~50 cm (15~19 inches) from your eyes to the screen. Look down at the screen and face the screen forwards.
- Maintain the correct posture when using this product.
- Adjust the angle of the product so that light is not reflected onto the screen.
- Keep your elbow at a right angle and keep your arm level with the back of your hand.
- Keep your elbow at a right angle.
- Place your heels flat on the ground while keeping your knees at an angle of 90 degrees or higher and maintain the position of your arm so that your arm is below your heart.

2 Installing the Product

2-1 Package Contents

- Unpack the product and check if all of the following contents have been included.
- Store the packaging box in case you need to move the product at a later stage.

| CONTENTS | | | |
|---|---|--|---|
|  |  |  |  |
| Quick Setup Guide | Product Warranty (Not available in all locations) | User Manual | D-Sub Cable |
|  |  |  |  |
| Power Cord | Batteries (AAA X 2) (Not available in all locations) | Stand Connector | Stand |
|  |  |  |  |
| Remote Control | Stereo Cable | Cleaning Cloth | Cable Holder |
| SOLD SEPARATELY | | | |
|  |  | | |
| DVI Cable | HDMI Cable | | |

- The cleaning cloth is supplied with black high-glossy models only.

2-2 Installing the Stand

 Before assembling the product, place the product down on a flat and stable surface so that the screen is facing downwards.



Insert the Stand Connector into the Stand Base in the direction shown by the figure.



Check if the Stand Connector is firmly connected.



Turn the connecting screw at the bottom of the stand fully so that it is completely fixed.



Place a soft cloth over the table to protect the product and place the product onto the cloth face down.



Hold the main body of the product with your hand as shown by the figure.
Push the assembled stand into the main body in the direction of the arrow as shown in the figure.



- Caution
Do not lift the product holding only the stand

2-3 Removing the Stand

 Before removing the stand, place the product down on a flat and stable surface so that the screen faces downwards.



Place a soft cloth over the table to protect the product and place the product face down.



Hold the main body of the product with your hand as shown by the figure.
Pull the stand in the direction of the arrow as shown in the figure to separate it.



Turn the connecting screw at the bottom of the stand to separate it.



Take the Stand Connector out of the Stand by pulling it in the direction of the arrow as shown in the figure.

2-4 Attaching a Wall Mount/Desktop Stand

Attaching a Wall Mount/Desktop Stand(not supplied)

This product provides a stand mount of 75 mm x 75 mm (2.95 x 2.95 inch) that complies with the VESA specifications.



A.Wall/Desktop Stand Mount

B.Wall mount kit/desktop stand (not supplied)

1. Turn the product off and unplug the power cord from the wall outlet.
2. Place a soft cloth or cushion on a flat surface to protect the panel and place the product face down.
3. Remove the screw from the stand and separate the stand.
4. Align the groove of the part of the product that is to be connected to the stand with the groove in the stand (desk-top stand, wall mount stand or another stand) and firmly fix the stand by fastening the screw.

- ! •If you use screws that are longer than the standard specifications, the inside of the product may be damaged.
 - For wall mounts that are not compatible with the standard VESA specifications, the length of the screw may differ depending on the corresponding specifications.
 - Avoid using screws that are incompatible with the standard VESA specifications and avoid assembling them using excessive force.
- This may result in damage to the product or injury due to the product falling. Samsung shall not be held liable for any damage or injury.
- Samsung shall not be held liable for any damage to the product or injury caused by using a stand that is not compatible with the specifications or due to an installation not performed by an authorized installation engineer.
 - When installing the product using a wall mount, purchase a wall mount that provides at least 10 cm (3.93 inches) of space from the wall.
 - Use the wall mount according to the international specifications.

2-5 Connecting to a Computer

1. Connect the product to a PC depending on the video output supported by the PC.

- 📌 The connecting part may differ depending on the product model.

When the graphics card provides a D-Sub (analogue) output

- Connect the [PC IN] port of the product to the D-Sub port of the PC with the D-Sub cable.

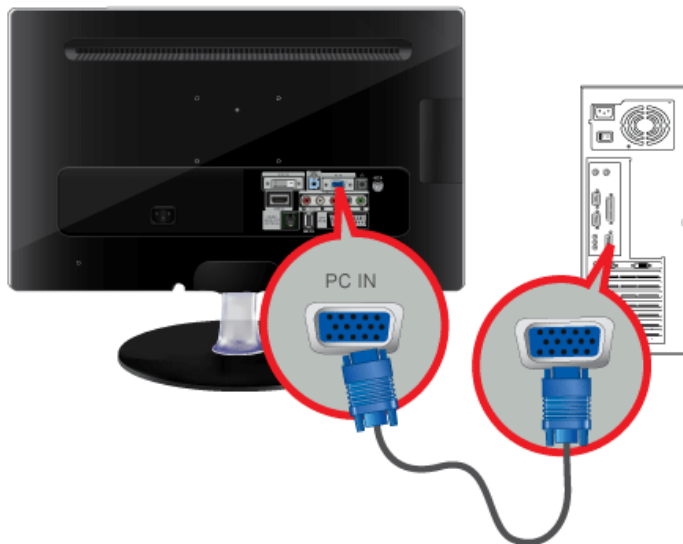

When the graphics card provides a DVI (digital) output

- Connect the [DVI-D IN] port of the product to the DVI port of the PC with the DVI cable.

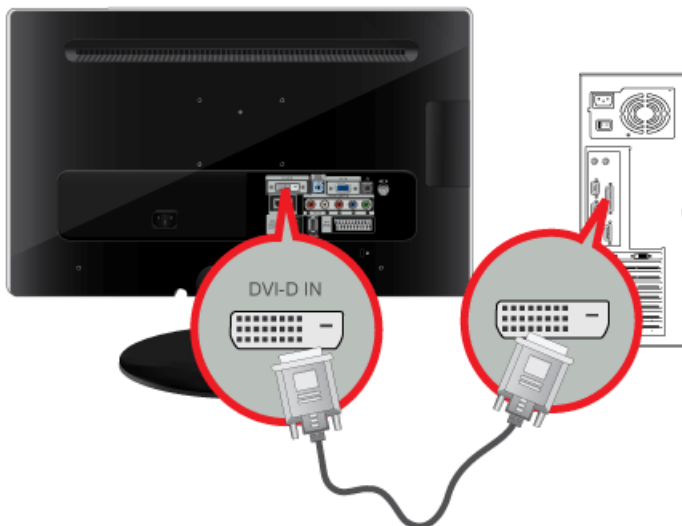

When the graphics card provides a HDMI output

- Connect the [HDMI IN] port of the product to the HDMI port of the PC with the HDMI cable.

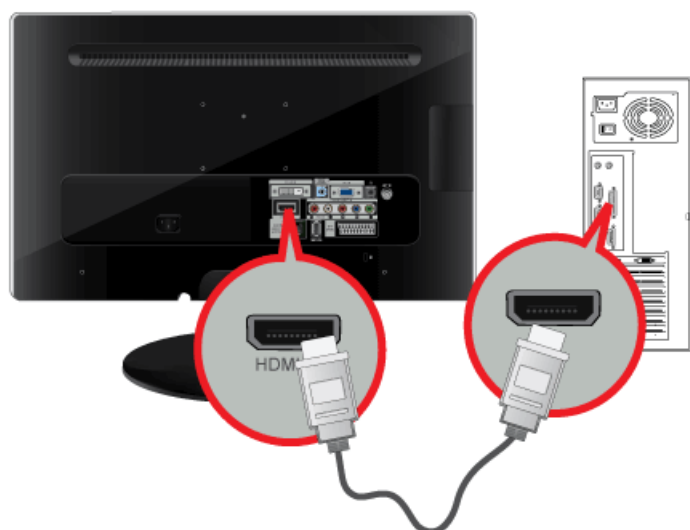

2. Connect the [HDMI/PC/DVI-D AUDIO IN] port on the rear side of the monitor to the sound card of the PC.

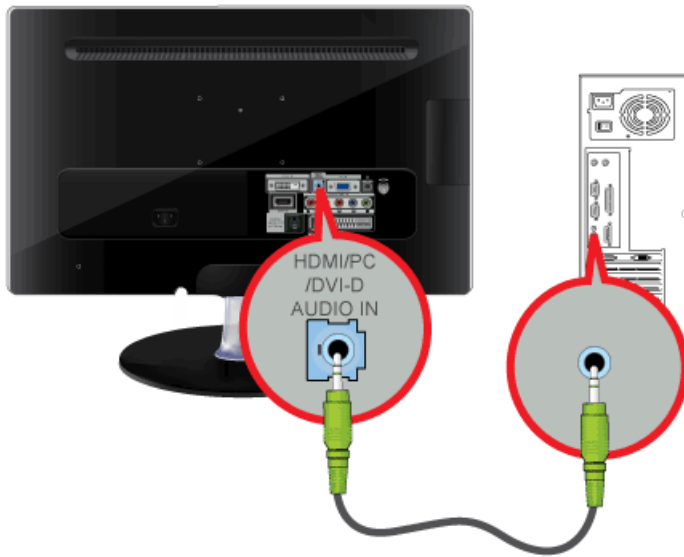

3. To use the monitor, connect the power cable to a power outlet and the [POWER] port on the monitor.
(The input voltage is switched automatically.)

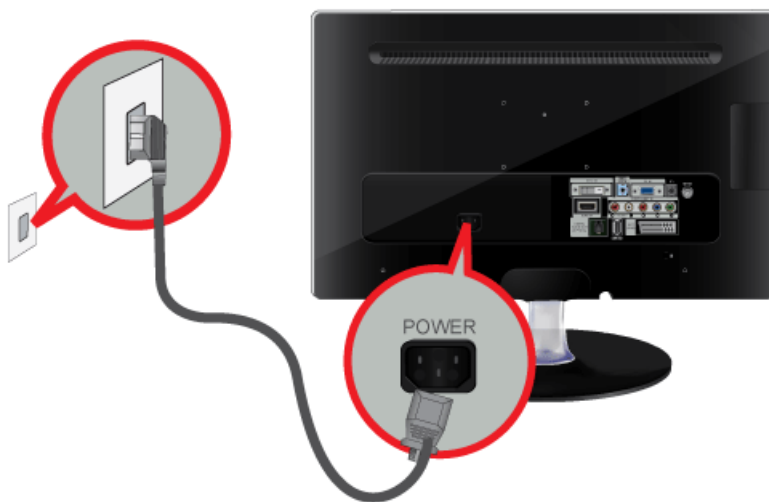

- You may enjoy clear and quality sound from the computer sound card using the monitor's speakers. (You don't need to install separate speakers for your computer.)
- You may get a blank screen depending on the type of video card you are using if you connect the D-sub and DVI cables simultaneously to one computer.
- If you connect your monitor properly using the DVI connector but get a blank or fuzzy screen, check to see if the monitor status is set to analogue. Press [] button to have the monitor double-check the input signal source.

2-6 Using it as a TV

You may view television programmes on the monitor if it is connected to an antenna or cable/satellite system without installing any separate TV reception hardware or software on your computer.



1. Connect the cable/satellite or TV antenna cable to the [ANT IN] port on the rear side of the monitor.
 - When using an indoor antenna/cable/satellite terminal:
Check the antenna terminal on the wall and then connect the antenna/cable/satellite TV cable.
 - When using an outdoor antenna:
When using an outdoor antenna, we strongly suggest using a qualified technician to install it.
 2. When the connections are completed, connect the TV power.
 3. When the product is turned on for the first time after it was purchased, the initial setup operations (<Plug&Play>) begin.
-  Be careful that the coaxial cable is not bent when connecting it to the antenna input terminal [ANT IN].

2-7 Connecting an HDMI cable

Connect the HDMI OUT port of the AV device (Blu-ray/DVD/Cable/Satellite box) to the [HDMI IN] terminal of the monitor using the HDMI cable.

Press the [SOURCE] button at the front of the monitor or on the remote control to select <HDMI> mode.

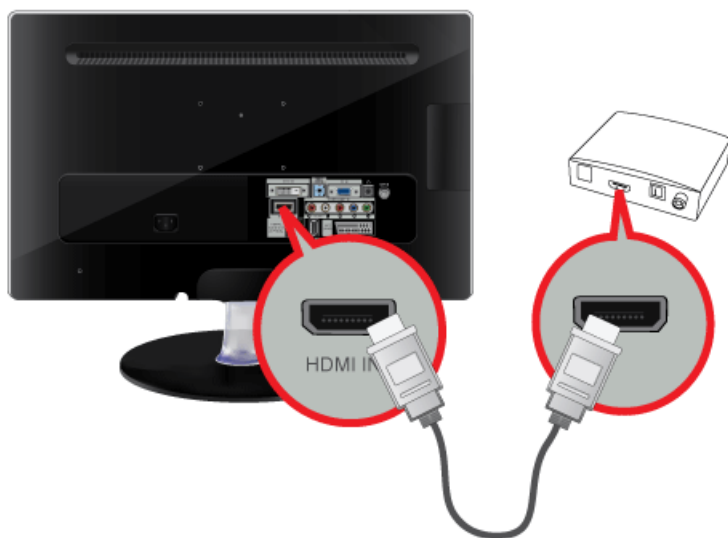

- You do not need to make a separate audio connection when connecting via HDMI.

2-8 Connecting Using a DVI to HDMI Cable

1. Connect the DVI output terminal of an external device to the [HDMI IN] terminal of the monitor using a DVI to HDMI cable.

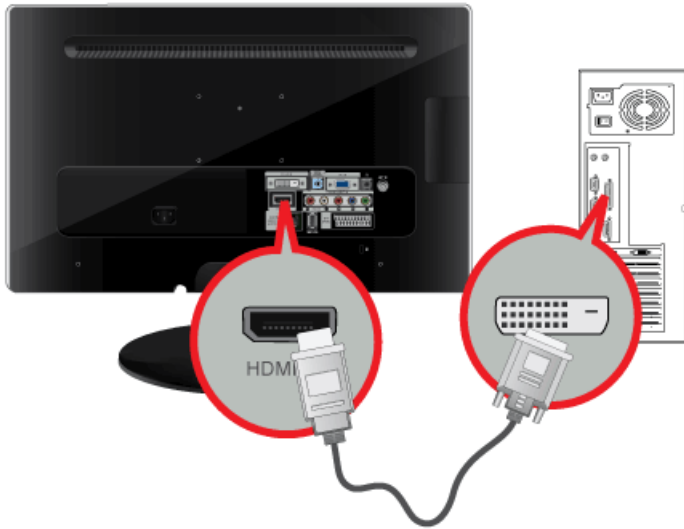

2. Connect the red and white plugs of an RCA to stereo (for PC) cable to the same coloured audio output terminals of the digital output device, and connect the opposite plug to the [HDMI/PC/DVI-D AUDIO IN] terminal of the product. Press the [SOURCE] button at the front of the monitor or on the remote control to select <HDMI> mode.

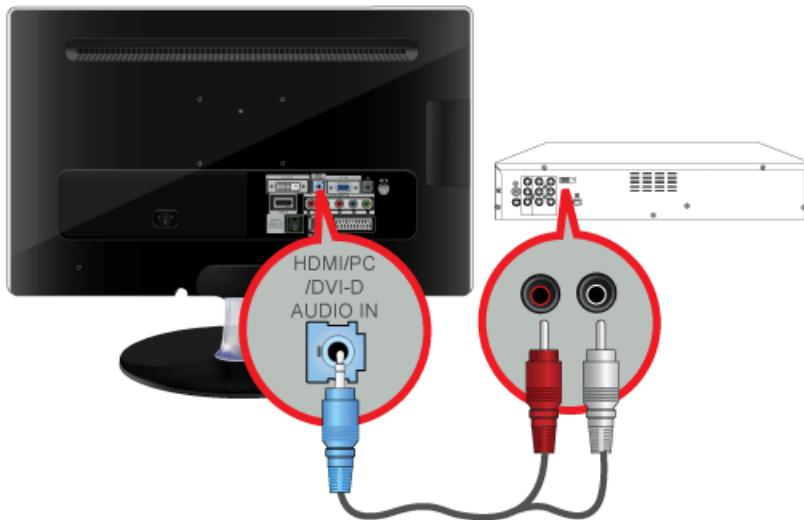

2-9 Connecting a Component cable

1. Connect the VIDEO OUT port of the AV device (DVD/VCR/Cable/Satellite box) to the [COMPONENT IN (P_R, P_B, Y)] input ports using a component video cable [P_R, P_B, Y].

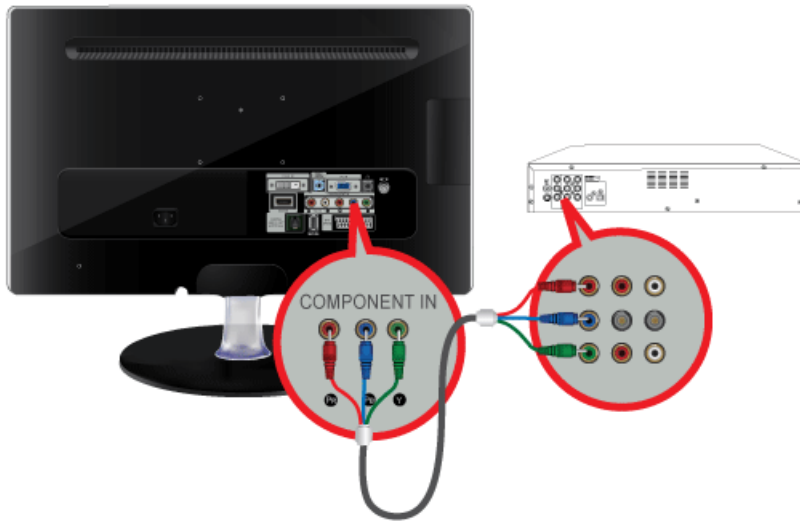

2. Connect the audio port of the AV device (DVD/VCR/Cable/Satellite box) to the [COMPONENT IN (R-AUDIO-L)] port of the monitor.

Press the [SOURCE] button at the front of the monitor or on the remote control to select the <Component> mode.

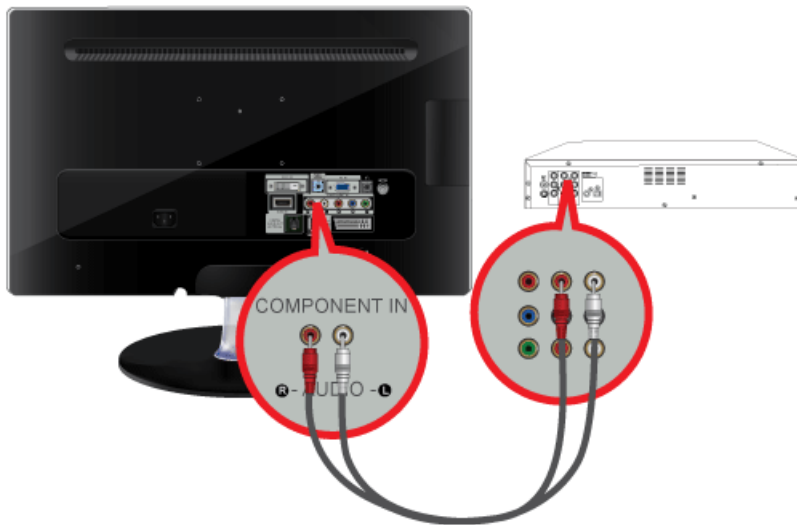

 For an explanation of Component video, consult your DVD/VCR/Cable/Satellite box manual.

2-10 Connecting a Scart cable

1. Connect the EXT(RGB) port of the monitor to the DVD Player using a SCART jack.
2. When a Scart device is connected to your monitor, the Source automatically changes to EXT.

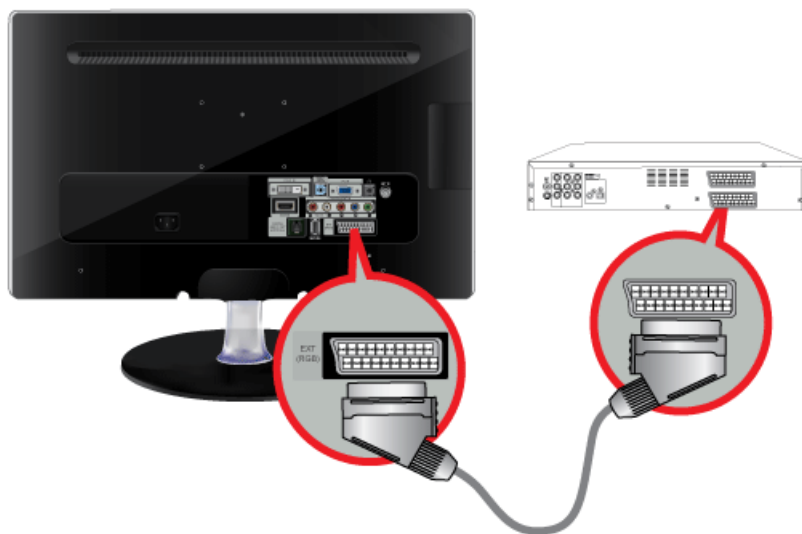

- Connect to the DVD Devices input if the device has a [EXT (RGB)] jack.
- You can watch DVD simply by hooking up the DVD player with the monitor as long as the power is on.

2-11 Connecting COMMON INTERFACE

1. Insert the CI CARD into the CAM in the direction of the arrow until it fits.
2. Insert the CAM with the CI CARD installed into the common interface slot.
(Insert the CAM in the direction of the arrow, right up to the end so that it is parallel with the slot.)
3. Check if you can see a picture on a scrambled signal channel.



- When not inserting 'CI CARD' in some channels, 'Scrambled Signal' is displayed on the screen.
- The pairing information containing a telephone number, CI CARD ID, Host ID and other information will be displayed in about 2~3 minutes. If an error message is displayed, please contact your service provider.
- When the channel information configuration has finished, the message 'Updating Completed' is displayed, indicating that the channel list is now updated.
- You must obtain a CI CARD from a local cable service provider. Remove the CI CARD by carefully pulling it out with your hands since dropping the CI CARD may cause damage to it.
- Insert the CI-Card in the direction marked on it.
- CAM is not supported in some countries and regions, check with your authorized dealer.

2-12 Connecting to an Amplifier

Connect the [DIGITAL AUDIO OUT (OPTICAL)] terminal of your monitor to the optical input of your amplifier using an optical cable.

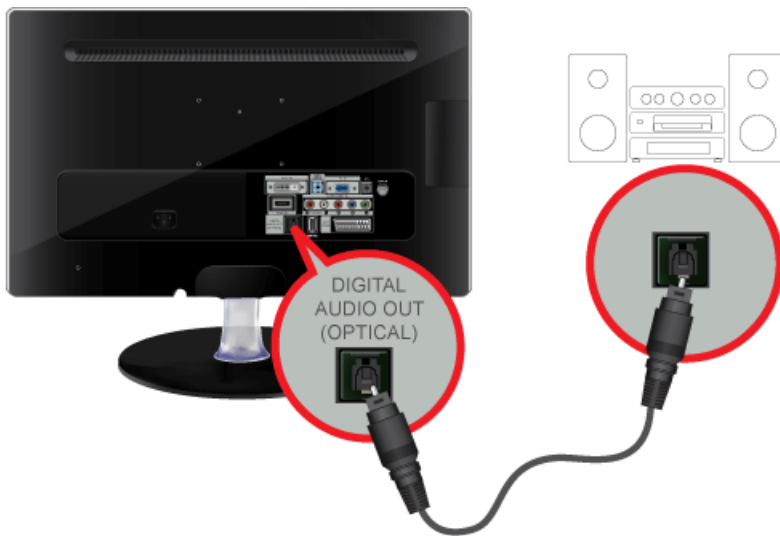

- If no sound is emitted from the monitor, you need to use an amplifier.
- For information on how to connect a speaker and amplifier, refer to the respective user manuals provided by their manufacturers.

2-13 Connecting Headphones

Connect your headphones to the Headphone connection terminal.



2-14 Kensington Lock

A Kensington Lock is an anti-theft device that enables users to lock the product so that they can safely use it in public locations. Since the shape and usage of the locking device may differ depending on the model and the manufacturer, refer to the User Manual supplied with the locking device for more information.

 You must purchase the Kensington Lock separately.



To lock the product, follow these steps:

1. Wrap the Kensington lock cable around a large, stationary object such as a desk or chair.
2. Slide the end of the cable with the lock attached through the looped end of the Kensington lock cable.
3. Insert the locking device into the Kensington slot on the Monitor (**B**).
4. Lock the lock (**A**).

 • These are general instructions. For exact instructions, see the User Manual supplied with the locking device.
• You can purchase the locking device from an electronics store or an online shop.

3 Using the Product

3-1 Plug & Play Feature

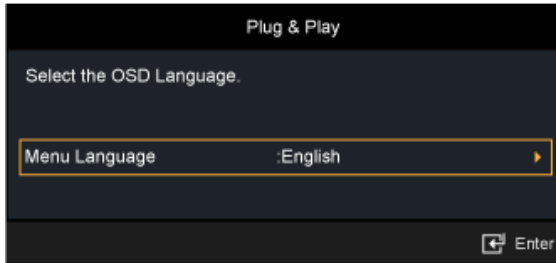

When the TV is initially powered on, basic settings proceed automatically and subsequently.

1. Press the [POWER] button on the remote control.

- You can also use the [] button on the TV.
- The message <Select the OSD Language.> is displayed.

2. Press the [] button. Select the appropriate language by pressing the ▲ or ▼ button. Press the [] button to confirm your choice.

3. Press the ◀ or ▶ button to select <Store Demo> or <Home Use>, then the [] button.

- We recommend setting the TV to <Home Use> mode for the best picture in your home environment.
- <Store Demo> mode is only intended for use in retail environments. If the unit is accidentally set to <Store Demo> mode and you want to return to <Home Use> (Standard): Press the volume button on the TV. When the volume OSD is displayed, press and hold the [MENU] button on the TV for 5 seconds.

4. Press the [] button. Select the appropriate country by pressing the ▲ or ▼ button. Press the [] button to confirm your choice.

5. Press the ▲ or ▼ button to select <Air> or <Cable>, then press the [] button.

- <Air>: <Air> antenna signal. / <Cable>: <Cable> antenna signal.
- In Cable mode, you can select the correct signal source among <Digital & Analogue>, <Digital>, and <Analogue> by pressing the ▲, ▼, ◀ or ▶ button, then press the [] button. If you have Digital cable, select the cable system signal source for both Analogue and Digital. Contact your local cable company to identify the type of cable system that exists in your particular area.

6. Press the ▲ or ▼ button to select the channel source to memorise. Press the [] button to select <Start>.

- When setting the antenna source to <Cable>, a step appears allowing you to set a value for the digital channel search. For more information, refer to <Channel> → <Auto Store>.
- <Digital & Analogue>: Digital and Analogue channels.
- <Digital>: Digital channels.
- <Analogue>: Analogue channels.
- The channel search will start and end automatically.
- Press the [] button at any time to interrupt the memorisation process.
- After all the available channels are stored, the message Set the <Clock Mode> is displayed.

7. Press the [] button.

Press the ▲ or ▼ button to select <Auto>, then Press the [] button.

- If you select <Manual>, <Set current date and time> is displayed.
- If you have received a digital signal, the time will be set automatically. If not, select <Manual> to set the clock.

8. The description for the connection method providing the best HD screen quality is displayed. Check the description and press the [ENTER] button.
9. The message <Enjoy your TV.> is displayed. When you have finished, press the [ENTER] button.

If you want to reset this feature...

1. Press the [MENU] button to display the menu. Press the ▲ or ▼ button to select <Setup>, then press the [ENTER] button.
2. Press the [ENTER] button again to select <Plug & Play>.
 -  • The <Plug & Play> feature is only available in the TV mode.
 - The default PIN number of a new TV set is 0-0-0-0.

3-2 Viewing the Control panel



- Touch one of the operating buttons lightly.
The LED buttons appear.

| ICON | DESCRIPTION |
|----------------|--|
| 1 [TV/PC] | Use this button to select a function. Signals other than the TV signal can only be selected if the corresponding device is connected. The order in which the TV/external input signal changes. <PC> → <TV> → <EXT.> → <DVI> → <Component> → <HDMI> |
| 2 [MENU] | Press this button to view the On Screen Display (OSD). This button is also used to exit the OSD or to return to a higher-level OSD menu. |
| 3 [-/+] | Moves from one menu item to another horizontally or adjusts selected menu values. Adjusts the audio volume. |
| 4 [V/Λ] | Use these buttons to navigate the menu or to adjust a value in the OSD. Press to change the channel. |
| 5 [⏻] | Press this button to turn the product on or off. Power LED This LED is turned on when the product works normally. <ul style="list-style-type: none"> For information about the power saving function, refer to the power saving function section of the product specifications. When not using the product for a long time, unplugging the power cord is recommended to minimize power consumption. |
| 6 Speakers | - |

3-3 Remote Control

The performance of the remote control may be affected by a TV or other electronic device operating near the product, causing a malfunction due to interference with the frequency.

- 1 POWER
Turns the product On/Off.
- 2 Number Buttons
Press to change the channel.
- 3
Activates a highlighted menu item.
- 4 + -
Press to increase or decrease the volume.
- 5 CH LIST
It displays "Channel List" on the screen.
- 6 MENU
Opens the on-screen menu and exits from the menu or closes the adjustment menu.
- 7 TOOLS
Use to quickly select frequently used functions.
- 8 Up-Down Left-Right buttons ENTER
Moves from one menu item to another horizontally, vertically or adjusts selected menu values.
- 9 INFO
Current picture information is displayed on the upper left corner of the screen.
- 10 Colour BUTTONS
Press to add or delete channels and to store channels to the Favourite channel list in the "Channel List" menu.
- 11 TTX / MIX
TV channels provide written information services via teletext.
 Teletext Feature

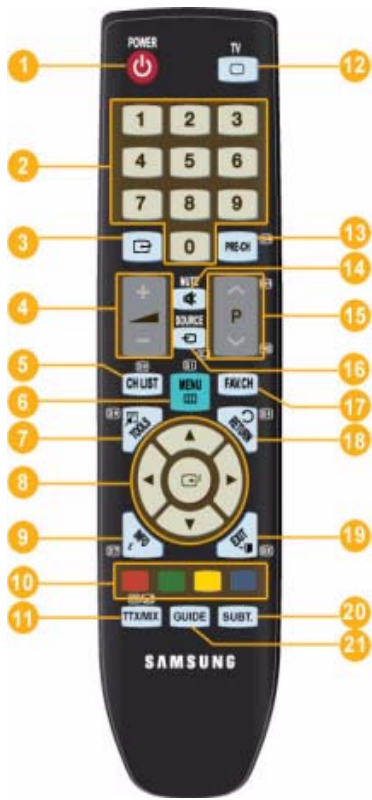

- 12 TV
Selects the TV mode directly.
- 13 PRE-CH
This button is used to return to the immediately previous channel.
- 14 MUTE
Press to temporarily cut off the sound.
- 15 P V
Press to change channels.
- 16 SOURCE
Press the button to change the input signal SOURCE.
Changing the SOURCE is only allowed for external devices that are connected to the monitor at the time.
- 17 FAV.CH
Press to switch to your favourites channels.
- 18 RETURN
Returns to the previous menu.
- 19 EXIT
Exits from the menu screen.
- 20 SUBT.
Digital subtitle display
- 21 GUIDE
Electronic programme Guide (EPG) display.

Installing Batteries in the Remote Control

1. Lift the cover at the back of the remote control upward as shown in the figure.

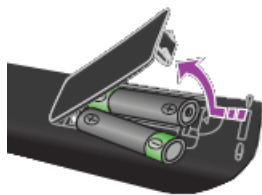

2. Install two AAA size batteries.

 Make sure to match the +and - ends of the batteries with the diagram inside the compartment.

3. Close the cover.

 Remove the batteries and store them in a cool, dry place if you won't be using the remote control for a long time.

If the remote control doesn't work, check the following :

- Is the TV power on?
- Are the plus and minus ends of the batteries reversed?
- Are the batteries drained?
- Is there a power outage or is the power cord unplugged?
- Is there a special fluorescent light or neon sign nearby?

3-4 Teletext Feature

Most television stations provide written information services via Teletext. The index page of the teletext service gives you information on how to use the service. In addition, you can select various options to suit your requirements by using the remote control buttons.

For teletext information to be displayed correctly, channel reception must be stable. Otherwise, information may be missing or some pages may not be displayed.

You can change teletext pages by pressing the numeric buttons on the remote control.

1 (exit)
Exit from the teletext display.

2 (index)
Used to display the index (contents) page at any time while you are viewing teletext.

3 (store)
Used to store the teletext pages.

4 (size)
Press to display the double-size letters in the upper half of the screen. For lower half of the screen, press it again. To display normal screen, press it once again.

5 (reveal)
Used to display the hidden text (answers to quiz games, for example). To display normal screen, press it again.

6 (teletext on/mix)
Press to activate teletext mode after selecting the channel providing the teletext service. Press it twice to overlap the teletext with the current broadcasting screen.

7 (sub-page)
Used to display the available sub-page.

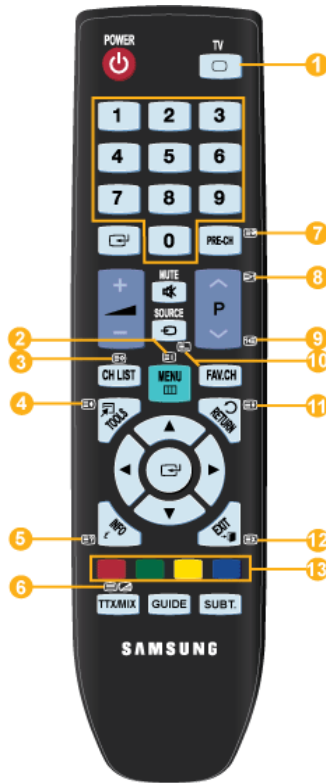

8 (page up)
Used to display the next teletext page.

9 (page down)
Used to display the previous teletext page.

10 (mode)
Press to select the teletext mode (LIST/FLOF). If you press it in the LIST mode, it switches into the List save mode. In the List save mode, you can save teletext page into list using the 3(store) button.

11 (hold)
Used to hold the display on a given page if the selected page is linked with several secondary pages which follow on automatically. To resume, press it again.

12 (cancel)
Used to display the broadcast when searching for a page.

13 Colour buttons (red / green / yellow / blue)
If the FASTEXT system is used by a broadcasting company, the different topics covered on a teletext page are colour-coded and can be selected by pressing the coloured buttons.

Press one of them corresponding to the required. The page is displayed with other coloured information that can be selected in the same way. To display the previous or next page, press the corresponding coloured button.

3-5 Using the Screen Adjustment Menu (OSD: On Screen Display)









The Screen Adjustment Menu (OSD: On Screen Display) Structure







| TOP MENU | SUB MENU | | | | | |
|--|-----------------------|------------------|---------------------|---------------------|------------------|--------------------|
| Picture [PC / DVI] | MagicBright | MagicAngle | Contrast | Brightness | Sharpness | Auto Adjust-ment |
| | Screen | Picture Options | Picture Reset | | | |
| Picture [TV / Ext. / Com- ponent / HDMI] | Mode | MagicAngle | Backlight | Contrast | Brightness | Sharpness |
| | Colour | Tint (G/R) | Advanced Set-tings | Picture Options | Picture Reset | |
| Sound | Mode | Equalizer | SRS TruSur-round HD | Audio Lan-guage | Audio Format | Audio Descrip-tion |
| | Auto Volume | Speaker Select | Sound Reset | | | |
| Channel | Country | Auto Store | Manual Store | Cable Search Option | Now & Next Guide | Full Guide |
| | Default Guide | Channel List | Channel Mode | Fine Tune | | |
| Setup | Plug & Play | Language | Time | Game Mode | Child Lock | Change PIN |
| | Parental Lock | Subtitle | Teletext Lan-guage | Preference | Digital Text | Light Effect |
| | Light Level | Melody | Energy Saving | Common Inter-face | | |
| Input | Source List | Edit Name | | | | |
| Application | Anynet+ (HDMI-CEC) | | | | | |
| Support | Self Diagnosis | Software Upgrade | HD Connection Guide | Contact Sam-sung | | |

Picture [PC / DVI]







- 🔑 The default setting may be different depending on the selected Input Mode (input signal source selected in External Input List) and the selected resolution



| MENU | DESCRIPTION |
|--|--|
| <p>MagicBright</p> | <p><MagicBright> is a feature providing an optimum viewing environment depending on the contents of the image you are watching. Currently five different modes are available: <Entertain>, <Internet>, <Text>, <Dynamic Contrast> and <Custom>. Each mode has its own pre-configured brightness value.</p> <ul style="list-style-type: none"> • <Entertain> High Brightness For watching motion pictures such as a Blu-Ray or DVD. • <Internet> For working with a mixture of images such as texts and graphics. • <Text> For documents or work involving heavy text. • <Dynamic Contrast> <Dynamic Contrast> automatically detects the distribution of the visual signal and adjusts to create an optimum contrast. • <Custom> Although the values are carefully chosen by our engineers, the pre-configured values may not be comfortable to your eyes depending on your taste. If this is the case, adjust the Brightness and Contrast by using the OSD menu. <p> Press the [TOOLS] button to display the <Tools> menu. You can also set the <MagicBright> by selecting <Tools>→<MagicBright>.</p> |
| <p>MagicAngle</p> | <p>This feature allows you to see optimal screen quality according to your viewing position.</p> <p>When viewing the screen at an angle from below, above or the side of the monitor, by setting the appropriate mode for each position you can obtain a similar picture quality as viewing the screen directly from the front.</p> <p> Set to <Off> when viewing directly in front of the screen.</p> <ul style="list-style-type: none"> • <Off>  - Select when viewing from the front position. • <Lean Back Mode1>  - Select when viewing from a slightly lower position. • <Lean Back Mode2>  - Select when viewing from the lower position. • <Standing Mode>  - Select when viewing from the upper position. • <Side Mode >  - Select when viewing from the left or right position. <div data-bbox="523 1420 1050 1659" data-label="Image"> </div> <p> Press the [TOOLS] button to display the Tools menu. You can also set the <MagicAngle> by selecting <Tools> → <MagicAngle>.</p> |
| <p>Contrast / Brightness / Sharpness</p> | <p>You can use the on-screen menus to change the contrast and brightness according to personal preference.</p> <ul style="list-style-type: none"> • <Contrast> - Adjust the Contrast. • <Brightness> - Adjust the Brightness. • <Sharpness> - Adjust the Sharpness. <p> Not available when <MagicBright> is <Dynamic Contrast>.</p> |

| MENU | DESCRIPTION |
|-----------------|---|
| Auto Adjustment | <p>The values of <Fine>, <Coarse> and <Position> are adjusted automatically. By changing the resolution in the control panel, auto function is performed.</p> <p> Available in <PC> Mode Only</p> <p> Press the [TOOLS] button to display the Tools menu. You can also set the auto adjustment by selecting <Tools> → <Auto Adjustment>.</p> |
| Screen | <ul style="list-style-type: none"> • <Coarse> Removes noise such as vertical stripes. <Coarse> adjustment may move the screen image area. You may relocate it to the center using the horizontal control menu. • <Fine> Removes noise such as horizontal stripes. If the noise persists even after <Fine> tuning, repeat it after adjusting the frequency (Coarse). • <PC Position> Adjusts the screen location horizontally and vertically. • <Image Reset> Image parameters are replaced with the factory default values. <p> Available in <PC> Mode Only</p> |
| Picture Options | <ul style="list-style-type: none"> • <Colour Tone> The tone of the Colour can be changed. <p> • Available in <PC>, <DVI> mode only • Not available when <MagicBright> is <Dynamic Contrast>.</p> <ul style="list-style-type: none"> • <Cool> - <Normal> - <Warm> - <Custom> <ul style="list-style-type: none"> • <R-Gain > - < G-Gain > - <B-Gain > Adjusts the individual R, G, B (Red, Green, Blue) Colour controls. <p> Not available when <MagicBright> is <Dynamic Contrast>.</p> <ul style="list-style-type: none"> • <Size> You can switch the Size. <ul style="list-style-type: none"> • <16:9> - <4:3> <p> Press the [TOOLS] button to display the Tools menu. You can also set the auto adjustment by selecting <Tools> → <Picture Size>.</p> |
| Picture Reset | <p>Picture parameters are replaced with the factory default values.</p> <ul style="list-style-type: none"> • <Reset Picture Mode> - <Cancel> |

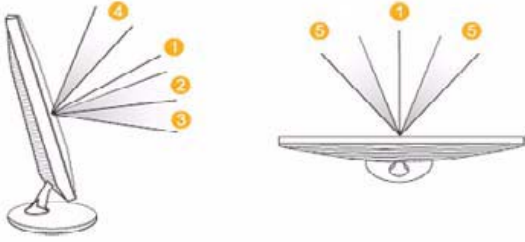

Picture [TV / Ext. / Component / HDMI]



| MENU | DESCRIPTION |
|-------------------|---|
| <p>Mode</p> | <p>You can select the type of picture which best corresponds to your viewing requirements. You can activate either <Dynamic>, <Standard> or <Movie>.</p> <ul style="list-style-type: none"> • <Dynamic> Selects the picture for high-definition in a bright room. • <Standard> Selects the picture for optimum display in a normal environment. • <Movie> Selects the picture for viewing movies in a dark room. <p> Press the [TOOLS] button to display the Tools menu. You can also set the <Picture Mode> by selecting <Tools>→<Picture Mode>.</p> |
| <p>MagicAngle</p> | <p>This feature allows you to see optimal screen quality according to your viewing position. When viewing the screen at an angle from below, above or the side of the monitor, by setting the appropriate mode for each position you can obtain a similar picture quality as viewing the screen directly from the front.</p> <ul style="list-style-type: none">  • Set to <Off> when viewing directly in front of the screen. • The <TV>, <Component>, <EXT.> and <HDMI> modes only support the <Lean Back Mode1> and <Lean Back Mode2> menus. <div style="text-align: center;">  </div> <p> Press the [TOOLS] button to display the Tools menu. You can also set the <MagicAngle> by selecting <Tools> → <MagicAngle>.</p> |





| MENU | DESCRIPTION |
|---|---|
| Backlight / Contrast / Brightness / Sharpness / Colour / Tint (G/R) | <p>Your product has several setting options that allow you to control the picture quality.</p> <ul style="list-style-type: none"> • <Backlight > - Adjusts the brightness of LCD back light. • <Contrast> - Adjusts the contrast level of the picture. • <Brightness> - Adjusts the brightness level of the picture. • <Sharpness> - Adjusts the edge definition of the picture. • <Colour> - Adjusts colour saturation of the picture. • <Tint (G/R)> - Adjusts the colour tint of the picture. <p> It is activated when the signal is NTSC.</p> |
| Advanced Settings | <p>Samsung's new TVs allow you to make even more precise picture settings than previous models. See below to adjust detailed picture settings.</p> <p> <Advanced Settings> is available in <Standard> or <Movie> mode.</p> <ul style="list-style-type: none"> • <Black Tone> - You can select the level on the screen to adjust the screen depth. <ul style="list-style-type: none"> • <Off> - <Dark> - <Darker> - <Darkest> • <Dynamic Contrast> -You can adjust the screen contrast so that the optimal contrast is provided. <ul style="list-style-type: none"> • <Off> - <Low> - <Medium> - <High> • <Gamma> - You can adjust the Primary colour (Red, Green, Blue) Intensity. • <Colour Space> - <Colour Space> is a colour matrix composed of red, green and blue colours. Select your favourite <Colour Space> to experience the most natural colour. <ul style="list-style-type: none"> • <Auto> - <Native> • <White Balance> - You can adjust the colour temperature for more natural picture colours. <ul style="list-style-type: none"> • <R-Offset> - <G-Offset> - <B-Offset> - <R-Gain> - <G-Gain> -<B-Gain> - <Reset> • <Flesh Tone> - You can emphasize the pink <Flesh Tone> in the picture. <p> Changing the adjustment value will refresh the adjusted screen.</p> • <Edge Enhancement> - You can emphasize object boundaries in the picture. <ul style="list-style-type: none"> • <Off> - <On> |

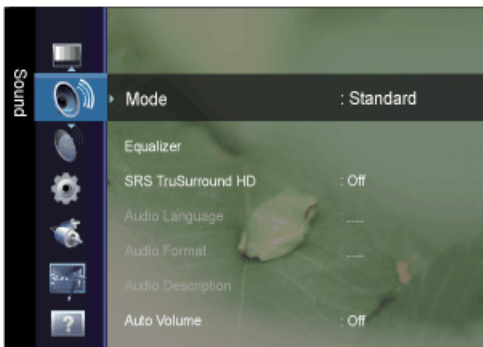

| MENU | DESCRIPTION |
|-----------------|--|
| Picture Options | <ul style="list-style-type: none"> • <Colour Tone> The tone of the colour can be changed. <ul style="list-style-type: none"> • <Cool> - <Normal> - <Warm1> - <Warm2> <ul style="list-style-type: none"> • <Warm1> or <Warm2> is only activated when the picture mode is <Movie>. • Settings can be adjusted and stored for each external device you have connected to an input of the TV. • <Size> You can switch the Size. <ul style="list-style-type: none"> • <Auto Wide> - Automatically adjusts the picture size to the "16:9" aspect ratio. • <16:9> - Adjusts the picture size to 16:9 appropriate for DVD or wide broadcasting. • <Wide Zoom> - Magnify the size of the picture more than 4:3. • <Zoom> - Magnifies the 16:9 wide picture (in the vertical direction) to fit the screen size. • <4:3> - This is the default setting for a video movie or normal broadcasting. • <Screen Fit> - Use the function to see the original image with no cut-off with HDMI (720p/ 1080i / 1080p) or Component (1080i / 1080p) signals are input. <p> Press the [TOOLS] button to display the <Tools> menu. You can also set the size by selecting <Tools>→<Picture Size>.</p> <ul style="list-style-type: none"> <ul style="list-style-type: none"> • Depending on the input source, the picture size options may vary. • The items available may differ depending on the selected mode. • Settings can be adjusted and stored for each external device you have connected to an input of the TV. • <Wide Zoom>: Press the ► button to Select Position, then press the [↔] button. Press the ▲ or ▼ button to move the picture up/down. Then press the [↔] button. • <Zoom>: Press the ► button to Select Position, then press the [↔] button. Press the ▲ or ▼ button to move the picture up and down. Then press the [↔] button. Press the ► button to Select Size, then press the [↔] button. Press the ▲ or ▼ button to magnify or reduce the picture size in the vertical direction. Then press the [↔] button. • After selecting <Screen Fit> in HDMI (1080i) or Component (1080i) mode: Select Position by pressing the ◀ or ▶ button. Use the ▲, ▼, ◀ or ▶ button to move the picture. • <Reset> : Press the ◀ or ▶ button to select <Reset>, then press the [↔] button. You can initialize the setting. • If you use the <Screen Fit> function with HDMI 720p input, 1 line will be cut at the top, bottom, left and right as in the Overscan function. • <Screen Mode> Digital Noise Reduction. Only when setting the picture size to <Auto Wide> can the user determine the <Screen mode>. Each individual European country requires a different picture size so this function is intended to help users to select it. <ul style="list-style-type: none"> • <16:9> - Sets the picture to 16:9 wide mode. • <Wide Zoom> - Magnify the size of the picture more than 4:3. • <Zoom> - Magnify the size of the picture vertically. • <4:3> - Sets the picture to 4:3 normal mode. <ul style="list-style-type: none"> <ul style="list-style-type: none"> • This function is available in <Auto Wide> mode. • This function is not available in <PC/DVI>, <Component> or <HDMI> mode. |

| MENU | DESCRIPTION |
|-----------------|--|
| Picture Options | <ul style="list-style-type: none"> • <Digital NR> Digital Noise Reduction. If the broadcast signal received by your TV is weak, you can activate the Digital Noise Reduction feature to help reduce any static and ghosting that may appear on the screen. <ul style="list-style-type: none"> • <Off> - <Low> - <Medium> - <High> - <Auto> • <HDMI Black Level> When a DVD or set-top box is connected to your TV via <HDMI>, it may cause a degradation in the screen quality, such as an increase in the black level, a low contrast, or discoloration, etc., depending on the external device connected. In this case, adjust the screen quality of your TV by configuring the <HDMI Black Level>. <p style="margin-left: 20px;"> This function is active only when the external device is connected via <HDMI>.</p> <ul style="list-style-type: none"> • <Normal> - <Low> • <Film Mode> The <Film Mode> feature offers you a theatre-quality viewing experience. <ul style="list-style-type: none"> • <Off> - <Auto> <p style="margin-left: 20px;"> <Film Mode> is supported in <TV>, <EXT.>, <Component> (480i / 1080i) and <HDMI>(480i / 1080i)</p> |
| Picture Reset | <p>Picture parameters are replaced with the factory default values.</p> <ul style="list-style-type: none"> • <Reset Picture Mode> - <Cancel> |

Sound



| MENU | DESCRIPTION |
|--------------------|---|
| Mode | <ul style="list-style-type: none"> • <Standard> Choose Standard for the standard factory settings. • <Music> Choose Music when watching music videos or concerts. • <Movie> Choose Movie when viewing movies. • <Clear Voice > Emphasizes voice over other sounds. • <Custom > Choose Custom if you want to adjust the settings according to personal preference . <p> Press the [TOOLS] button to display the <Tools> menu. You can also set the <Sound Mode> by selecting <Tools> → <Sound Mode>.</p> |
| Equalizer | <p>You can adjust the left and right sound balance and equalizer settings as required.</p> <ul style="list-style-type: none"> • <Mode> You can select a sound mode to suit your personal preferences. • <Balance> You can adjust the left and right sound balance and equalizer settings as required. • <100Hz> - <300Hz> - <1KHz> - <3KHz> - <10KHz> To adjust the level of different bandwidth frequencies. • <Reset> Resets the equalizer settings to the default values. |
| SRS TruSurround HD | <p><SRS TruSurround HD> is a patented SRS technology that solves the problem of playing 5.1 multi-channel content over two speakers.</p> <p>TruSurround delivers a compelling, virtual surround sound experience through any two-speaker playback system, including internal television speakers. It is fully compatible with all multichannel formats.</p> <ul style="list-style-type: none"> • <Off> - <On> <p> Press the [TOOLS] button to display the <Tools> menu. You can also set the <Picture Mode> by selecting <Tools> → <SRS TruSurround HD>.</p> |
| Audio Language | <p>You can change the default value for audio languages. Displays the language information for the incoming stream.</p> <ul style="list-style-type: none">  • While viewing a digital channel, this function can be selected. • You can only select the language among the actual languages being broadcast. |
| Audio Format | <p>When sound is emitted from both the main speaker and the audio receiver, a sound echo may occur due to the decoding speed difference between the main speaker and the audio receiver. In this case, use the TV Speaker function.</p> <ul style="list-style-type: none"> • <MPEG> - <Dolby Digital> <ul style="list-style-type: none">  • While viewing a digital channel, this function can be selected. • The <Audio Format> appears according to the broadcasting signal. |

| MENU | DESCRIPTION |
|-------------------|---|
| Audio Description | <p>This is an auxiliary audio function that provides an additional audio track for visually challenged persons. This function handles the Audio Stream for the AD (Audio Description), when it is sent along with the Main audio from the broadcaster. Users can turn the <Audio Description> On or Off and control the volume.</p> <ul style="list-style-type: none"> • <Audio Description> Turn the audio description function on or off. • <Volume> You can adjust the audio description volume. <ul style="list-style-type: none"> • Volume is active when <Audio Description> is set to On. <p> While viewing a Digital channel, this function can be selected.</p> |
| Auto Volume | <p>Reduces the differences in volume level among channels.</p> <ul style="list-style-type: none"> • <Off> - <On> |
| Speaker Select | <p>If you want to hear the sound through separate speakers, cancel the internal amplifier.</p> <ul style="list-style-type: none"> • <External Speaker> - <TV Speaker> <p> • If you select <External Speaker> in the <Speaker Select> menu, the sound settings will be limited.</p> <ul style="list-style-type: none"> • The volume and [MUTE] buttons do not operate when the <Speaker Select> is set to <External Speaker>. Please set the volume on your Home theatre. |
| Sound Reset | <p>You can restore the <Sound> settings to the factory defaults.</p> <ul style="list-style-type: none"> • <Reset All> - <Reset Sound Mode> - <Cancel> <p> <Reset Sound Mode>: Current sound values return to default settings.</p> |

Selecting the Sound Mode



You can set the sound mode in the <Tools> menu. When you set to <Dual I II> the current sound mode is displayed on the screen

| | Audio Type | Dual 1 / 2 | DUAL 1 / 2 |
|-----------------|------------|-----------------------------|------------------|
| A2 Stereo | Mono | MONO | Automatic change |
| | Stereo | STEREO ↔ MONO | Automatic change |
| | Dual | DUAL 1 ↔ DUAL 2 | DUAL 1 |
| NICAM Stereo | Mono | MONO | Automatic change |
| | Stereo | MONO ↔ STEREO | Automatic change |
| | Dual | MONO ↔ DUAL 1 ↙ DUAL 2 ↘ | DUAL 1 |



-  If the stereo signal is weak and an automatic switching occurs, then switch to the mono.
This function is only activated in stereo sound signal. It is deactivated in mono sound signal.
This function is only available in TV mode.











Channel



| MENU | DESCRIPTION |
|------------|---|
| Country | <p>Select the country in which the product is being used before you use the Auto Store feature. If you do not see your country in the list, select others.</p> <ul style="list-style-type: none"> • <Digital Channel> You can change the country for digital channels. • <Analogue Channel> You can change the country for analogue channels. <p> The PIN number input screen appears. Enter your 4 digit PIN number.</p> |
| Auto Store | <p>You can scan for the frequency ranges available to you (and availability depends on your country). Automatically allocated programme numbers may not correspond to actual or desired programme numbers.</p> <p> If a channel is locked using the <Child Lock> function, the PIN input window appears.</p> <ul style="list-style-type: none"> • <Air / Cable> Antenna source to memorise. <ul style="list-style-type: none"> • <Digital & Analogue> Digital and Analogue channels. • <Digital > Digital channels. • <Analogue > Analogue channels. <p>When selecting <Cable> → <Digital & Analogue> or <Cable>→ < Digital >: Provide a value to scan for cable channels.</p> <ul style="list-style-type: none"> • <Search Mode> Full / Network / Quick <p>Quick</p> <ul style="list-style-type: none"> • <Network ID> Displays the network identification code. • <Frequency> Displays the frequency for the channel. (Differs in each country) • <Modulation> Displays available modulation values. • <Symbol Rate> Displays available symbol rates. <p> Scans for all channels with active broadcast stations and stores them in the TV's memory.</p> |

| MENU | DESCRIPTION |
|---|---|
| Manual Store | <p>You can scan the frequency ranges available on your television in your area and store all the channels found manually.</p> <ul style="list-style-type: none"> • <Digital Channel> Manual store for digital channels. <ul style="list-style-type: none"> • <Channel> Set the Channel number using the ▲, ▼ or number (0~9) buttons • <Frequency> Set the frequency using the number buttons. • <Bandwidth> Set the bandwidth using the ▲, ▼ or number (0~9) buttons.  • <Digital Channel> is only available in DTV mode. <ul style="list-style-type: none"> • When it has finished, channels are updated in the channel list. • <Analogue Channel> Manual store for analogue channel. <ul style="list-style-type: none"> • <Programme> (Programme number to be assigned to a channel) Inputting the appropriate programme number on the screen. Sets the programme number using the ▲, ▼ or number (0~9) buttons • <Colour System> Adjusts repeatedly until the colour is of the best quality. Sets the colour system value using the ▲ or ▼ button. <ul style="list-style-type: none"> • <Auto>-<PAL>-<SECAM>-<NTSC4.43> • <Sound System> Adjusts repeatedly until the sound is of the best quality. Sets the sound system value using the ▲ or ▼ button. <ul style="list-style-type: none"> • <BG>-<DK>-<I>-<L> • <Channel> (When you know the number of the channel to be stored) You can store television channels, including those received via cable networks. When storing channels manually, you can choose: Whether or not to store each of the channels found. The Programme number of each stored channel which you wish to identify <ul style="list-style-type: none"> • <C> (Air channel mode) You can select a channel by entering the assigned number to each air broadcasting station in this mode. • <S> (Cable channel mode) You can select a channel by entering the assigned number for each cable channel in this mode. • <Search> (When you do not know the channel numbers) Press the ▲ or ▼ button to start the search. The tuner scans the frequency range until the first channel or the channel that you selected is received on your screen. • <Store> (When you store the channel and associated programme number) It's used to restore the number user inputs. Set to OK by pressing the [OK] button. |
| Cable Search Option (depending on the country) | <p>Using this function, you can manually add the channel range to be scanned by full search mode of the <Auto Store> function.</p> <ul style="list-style-type: none"> • <Frequency (Start~Stop)> Displays the frequency for the channel. • <Modulation> Displays available modulation values. • <Symbol Rate> Displays available symbol rates. |

| MENU | DESCRIPTION |
|---|---|
| Now & Next Guide / Full Guide / Default Guide | <p>The EPG (Electronic Programme Guide) information is provided by the broadcasters. Programme entries may appear blank or out of date as a result of the information broadcast on a given channel. The display will dynamically update as soon as new information becomes available.</p> <p> You can also display the guide menu simply by pressing the [GUIDE] button. (To configure the <Default Guide>, refer to the descriptions.)</p> <ul style="list-style-type: none"> • <Now & Next Guide> For the six channels indicated in the left-hand column, displays the Current programme and the Next programme information. • <Full Guide> Displays the programme information as time ordered One hour segments. Two hours of programme information is displayed which may be scrolled forwards or backwards in time. <ul style="list-style-type: none"> •  The programme title is on the upper part of the screen center. Please click on INFO button for the detailed information. Channel Number, Running Time, Status Bar, Parental Level, Video Quality Information(HD/SD), Sound Modes, Subtitle or Teletext, Languages of Subtitle or Teletext, and brief summary of the highlighted programme are included on the detailed information. • "... " will be appeared if the summary is long. • Six channels are displayed. To scroll between channels, move to a channel using the ▲ or ▼ button. • <Default Guide> You can decide whether to display either the <Now & Next Guide> or the <Full Guide> when the GUIDE button on the remote control is pressed. <ul style="list-style-type: none"> • <Now & Next> - <Full Guide> |





| MENU | DESCRIPTION |
|--------------|---|
| Channel List | <p>Using this menu, you can Add / Delete or set Favourite channels and use the programme guide for digital broadcasts.</p> <p>You can select these options by simply pressing the [CH LIST] button on the remote control.</p> <ul style="list-style-type: none"> • <All Channels> - Shows all currently available channels. • <Added Channels> - Shows all added channels. • <Favourites> - Shows all favourite channels. <p> Press the [TOOLS] button to display the <Tools> menu. You can also set the add to (or delete from) <Favourite> by selecting [Tools] → <Add to Favourite> (or <Delete from Favourite>).</p> <p> To select the Favourites channels you have set up, press the [FAV.CH] button on the remote control.</p> <ul style="list-style-type: none"> • <Programmed> - Shows all current reserved programmes. <p> • Select a channel in the <All Channels>, <Added Channels> or <Favourites> screen by pressing the ▲ / ▼ buttons, and pressing the [↔] button. Then you can watch the selected channel.</p> <ul style="list-style-type: none"> • Using the Colour buttons with the <Channel List>. <ul style="list-style-type: none"> • <Red> (Channel Type): Toggle between your TV, Radio, Data / Other and All. • <Green> (Zoom): Enlarges or shrinks a channel number. • <Yellow> (Select): Selects multiple channel lists. You can perform the Add / Delete or Add to Favourite / Delete from Favourite function for multiple channels at the same time. Select the required channels and press the yellow button to set all the selected channels at the same time. The check mark appears to the left of the selected channels. • <TOOLS> (Tools): Displays the <Delete> (or <Add>), <Add to Favourite> (or <Delete from Favourite>), <Lock> (or <Unlock>), <Select All> (or <Deselect All>), <Auto Store>. (The Options menus may differ depending on the situation.) • Channel Status Display Icons <ul style="list-style-type: none"> • : An analogue channel. • : A channel set as a Favourite. • : A channel selected by pressing the yellow button. • : A programme currently being broadcast. • : A locked channel. • : A reserved programme. |
| Channel Mode | <p>When press the P[^ / v] button, channels will be switched within the selected channel list.</p> <ul style="list-style-type: none"> • <Added Ch.> Channels will be switched within the memorised channel list. • <Favourite Ch.> Channels will be switched within the favourite channel list. |
| Fine Tune | <p>Use fine tuning to manually adjust a particular channel for optimal reception.</p> <p> • If you do not store the fine-tuned channel in memory, adjustments are not saved.</p> <ul style="list-style-type: none"> • Fine tuned channels that have been saved are marked with an asterisk '*' on the right-hand side of the channel number in the channel banner. • To reset the fine tuning setting, press the ▼ button to select <Reset>, then press the [↔] button. • Only Analogue TV channels can be fine tuned. |





Setup





| MENU | DESCRIPTION |
|-------------|---|
| Plug & Play | This brings up the menu items that appeared when you first plugged in the TV.  The default PIN number of a new TV set is 0-0-0-0. |
| Language | The language chosen affects only the language of the OSD. |

| MENU | DESCRIPTION |
|------|--|
| Time | <ul style="list-style-type: none"> • <Clock> Setting the clock is necessary in order to use the various timer features of the TV. • <Clock Mode> You can set up the current time manually or automatically. <ul style="list-style-type: none"> • <Auto> - <Manual> <ul style="list-style-type: none"> • Depending on the broadcast station and signal, the auto time may not be set correctly. If this occurs, set the time manually. • The Antenna or cable must be connected in order to set the time automatically. • <Clock Set> You can set the current time manually. <ul style="list-style-type: none"> • This function is only available when <Clock Mode> is set to <Manual>. • You can set the day, month, year, hour and minute directly by pressing the number buttons on the remote control. • The current time will appear every time you press the [INFO] button. <ul style="list-style-type: none"> • If you disconnect the power cord, you have to set the clock again. • <Sleep Timer> The sleep timer automatically shuts off the TV after a preset time . <ul style="list-style-type: none"> • <Off> - <30 min> - <60 min> - <90 min> - <120 min> - <150 min> - <180 min> <p> Press the [TOOLS] button to display the <Tools> menu. You can also set the sleep timer by selecting <Tools> → <Sleep Timer>.</p> <ul style="list-style-type: none"> • To cancel the <Sleep Timer> function, select <Off>. • <Timer1 / Timer2 / Timer3> Three different on / off timer settings can be made. You must set the clock first. <ul style="list-style-type: none"> • <On Time> Set the hour, minute, and <activate/inactivate>. (To activate the timer with the setting you've chosen, set to Activate.) • <Off Time> Set the hour, minute, and <activate/inactivate>. (To activate the timer with the setting you've chosen, set to Activate.) • <Volume> Set the desired volume level. • <Antenna> View antenna type. (<Air> or <Cable>). <ul style="list-style-type: none"> • You can set the <Antenna> by selecting <Channel> → <Antenna>. • <Channel> Select the desired channel. • <Repeat> Select <Once>, <Everyday>, <Mon~Fri>, <Mon~Sat>, <Sat~Sun> or <Manual>. <ul style="list-style-type: none"> • When <Manual> is selected, press the ► button to select the desired day of the week. Press the [] button over the desired day and the (✓) mark will appear. • You can set the <hour>, <minute> and channel by pressing the number buttons on the remote control. • <Auto Power Off> When you set the timer On, the television will eventually turn off if no controls are operated for 3 hours after the TV was turned on by the timer. This function is only available in timer On mode and prevents overheating, which may occur if a TV is on for too long time. |

| MENU | DESCRIPTION |
|---------------|--|
| Game Mode | <p>When connecting to a game console such as PlayStation™ or Xbox™, you can enjoy a more realistic gaming experience by selecting game menu.</p> <ul style="list-style-type: none"> • <Off> - <On> <p> • Restrictions on game mode (Caution)</p> <ul style="list-style-type: none"> • To disconnect the game console and connect another external device, set <Game Mode> to <Off> in the setup menu. If you display the TV menu in <Game mode>, the screen shakes slightly. • If <Game Mode> is <On> : <ul style="list-style-type: none"> • <Picture> mode is automatically changed to <Standard> and cannot be changed. • <Sound> mode is automatically changed to <Custom> and cannot be changed. Adjust the sound using the equalizer. • <Game Mode> is not available in regular <TV> and <PC> mode. • If the picture is poor when external device is connected to TV, check if <Game Mode> is <On>. Set <Game Mode> to <Off> and connect external devices. |
| Child Lock | <p>This feature allows you to prevent unauthorized users, such as children, from watching unsuitable programme by muting out video and audio.</p> <ul style="list-style-type: none"> • <Off>-<On> <p> • Before the setup screen appears, the PIN number input screen appears. Enter your 4 digit PIN number.</p> <ul style="list-style-type: none"> • The default PIN number of a new TV set is 0-0-0-0. You can change the PIN by selecting <Change PIN> from the menu. • You can lock some channels in <Channel List>. • <Child Lock> is available only in TV mode. |
| Change PIN | <p>You can change your personal ID number that is required to set up the TV.</p> <p> • Before the setup screen appears, the PIN number input screen appears. Enter your 4digit PIN number.</p> <ul style="list-style-type: none"> • The default PIN number of a new TV set is 0-0-0-0. • If you forget the PIN code, press the remote control buttons in the following sequence, which resets the PIN to 0-0-0-0: [POWER] (Off) → [MUTE] → 8 → 2 → 4 → [POWER] (On). |
| Parental Lock | <p>This feature allows you to prevent unauthorized users, such as children, from watching unsuitable programme by a 4-digit PIN (Personal Identification Number) code that is defined by the user.</p> <ul style="list-style-type: none"> • <Allow All> Press to unlock all TV ratings. • <Block All> Press to lock all TV ratings. <p> • Before the setup screen appears, the PIN number input screen appears. Enter your 4 digit PIN number.</p> <ul style="list-style-type: none"> • The default PIN number of a new TV set is 0-0-0-0. You can change the PIN by selecting Change PIN from the menu. • When the parental ratings are set, the  symbol is displayed. |

| MENU | DESCRIPTION |
|-------------------|--|
| Subtitle | <p>You can activate and deactivate the subtitles. Use this menu to set the <Mode>.</p> <p><Normal> under the menu is the basic subtitle and <Hard of hearing> is the subtitle for a hearing-impaired person.</p> <ul style="list-style-type: none"> • <Subtitle> Switches subtitles on or off. • <Mode> Sets the subtitle mode. <ul style="list-style-type: none"> • <Normal> / <Hard of hearing> • <Subtitle Language> Set the subtitle language. <p> • If the programme you are watching does not support the <Hard of hearing> function, <Normal> automatically activates even though <Hard of hearing> mode is selected.</p> <ul style="list-style-type: none"> • English is the default in cases where the selected language is unavailable in the broadcast. • You can select these options simply by pressing the [SUBT]. button on the remote control. |
| Teletext Language | <p>You can set the <Teletext language> by selecting the language type.</p> <p> English is the default in cases where the selected language is unavailable in the broadcast.</p> |
| Preference | <p><Primary Audio Language> / <Secondary Audio Language> / <Primary Subtitle Language> / <Secondary Subtitle Language> / <Primary Teletext Language> / <Secondary Teletext Language></p> <p>Using this feature, users can select one of the languages. The language selected here is the default when the user selects a channel.</p> <p>If you change the language setting, the Subtitle Language, Audio Language, and the Teletext Language of the Language menu are automatically changed to the selected language.</p> <p>The Subtitle Language, Audio Language, and the Teletext Language of the Language menu show a list of languages supported by the current channel and the selection is highlighted.</p> <p>If you change this language setting, the new selection is only valid for the current channel. The changed setting does not change the setting of the Primary Subtitle Language, Primary Audio Language, or the Primary Teletext Language of the Preference menu.</p> |
| Digital Text | <p>If the programme is broadcast with digital text, this feature is enabled.</p> <ul style="list-style-type: none"> • <Disable>-<Enable> (UK only) <p> • MHEG (Multimedia and Hypermedia Information Coding Experts Group)</p> <ul style="list-style-type: none"> • An International standard for data encoding systems used in multimedia and hypermedia. This is at a higher level than the MPEG system which includes data-linking hypermedia such as still images, character service, animation, graphic and video files as well as multimedia data. MHEG is user runtime interaction technology and is being applied to various fields including VOD (Video-On-Demand), ITV (Interactive TV), EC (Electronic Commerce), tele-education, tele-conferencing, digital libraries and network games. |
| Light Effect | <p>You can turn the LED on/off on the front of monitor. You can turn it off to save power.</p> <ul style="list-style-type: none"> • <Off> Activates the <Light Effect> (LED) only when a button is pressed. • <On> Activates the <Light Effect> (LED) only while watching the TV. |
| Light Level | <p>Use to adjust the light level i.e., the brightness of the light.</p> <ul style="list-style-type: none"> • <1>~<10> <p> The higher the number, the brighter the light of the LED emits.</p> |

| MENU | DESCRIPTION |
|------------------|---|
| Melody | <p>A melody sound can be set to come on when the monitor is powered On or Off.</p> <ul style="list-style-type: none"> • <Off> - <Low> - <Medium> - <High> <p> The <Melody> does not play</p> <ul style="list-style-type: none"> • When no sound is output from the TV because the [MUTE] button has been pressed. • When no sound is output from the TV because the volume has been reduced to minimum with the volume [-] button. • When the TV is turned off by <Sleep Timer> function. |
| Energy Saving | <p>This feature adjusts the brightness of the TV in order to reduce power consumption. When watching TV at night, set the <Energy Saving> mode option to <High> to reduce eye fatigue as well as power consumption.</p> <ul style="list-style-type: none"> • <Off> : Turns off the energy saving function. • <Low> : Sets the TV to low energy saving mode. • <Medium> : Sets the TV to medium energy saving mode. • <High> : Sets the TV to high energy saving mode. • <Auto> : Automatically adjusts the brightness of the TV screen in accordance with the scenes. <p> Press the [TOOLS] button to display the <Tools> menu. You can also set the <Energy Saving> option by selecting <Tools> → <Energy Saving>.</p> |
| Common Interface | <ul style="list-style-type: none"> • <CI Menu> This enables the user to select from the CAM-provided menu. Select the CI Menu based on the menu PC Card. • <Application Info.> This contains information on CAM inserted in the CI slot and displays it. The Application Info inserting is about the CI CARD. You can install the CAM anytime whether the TV is ON or OFF. <p> CAM is not supported in some countries and regions, check with your authorized dealer.</p> |

Input

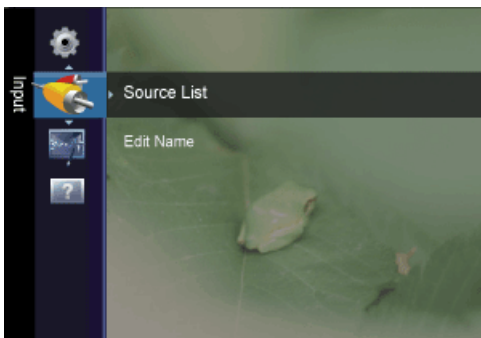

| MENU | DESCRIPTION |
|-------------|--|
| Source List | <p>Use to select <PC>, <TV> or an external input source connected to the Monitor. Use to select the screen of your choice.</p> <p>You can use the [SOURCE] button on the remote control.</p> <ul style="list-style-type: none"> <PC> - <TV> - <Ext.> - <DVI> - <Component> - <HDMI> |
| Edit Name | <p>Name the input device connected to the input jacks to make your input source selection easier.</p> <ul style="list-style-type: none"> <VCR> - <DVD> - <Cable STB> - <Satellite STB> - <PVR STB> - <AV Receiver> - <Game> - <Camcorder> - <PC> - <DVI PC> - <DVI> - <TV> - <IPTV> - <Blu-ray> - <HD DVD> - <DMA> <p> When a PC with a resolution of 1920 x 1080@60Hz is connected to the [HDMI IN] port, you should set the <HDMI> mode to <DVI PC> in the <Edit Name> of the <Input> mode. In this case, a separate sound connection is required.</p> |

Application

Anynet+ (HDMI-CEC)

What is <Anynet+>?

<Anynet+> is a function that enables you to control all connected **Samsung** devices that support <Anynet+> with your Samsung TV's remote. The <Anynet+> system can be used only with **Samsung** devices that have the <Anynet+> feature. To be sure your Samsung device has this feature, check if there is an <Anynet+> logo on it.

Connecting Anynet+ Devices

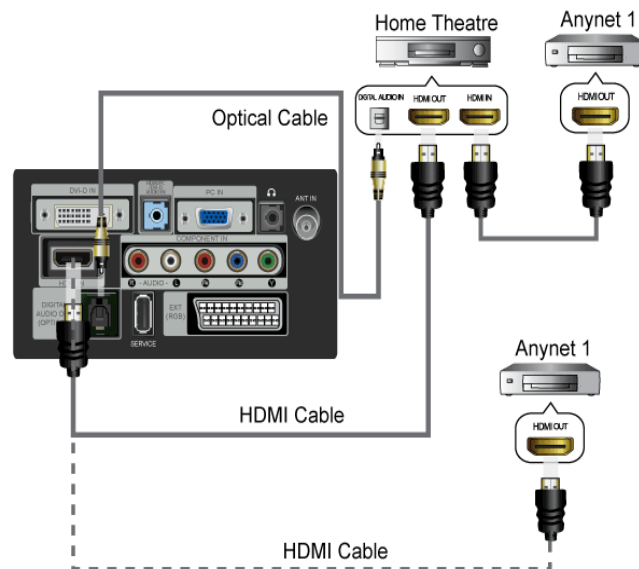

1. Connect the [HDMI IN] jack on the TV and the HDMI OUT jack of the corresponding <Anynet+> device using an **HDMI** cable.
2. Connect the [HDMI IN] jack of the home theatre and the HDMI OUT jack of the corresponding <Anynet+> device using an **HDMI** cable.

 Connect the Optical cable between the [DIGITAL AUDIO OUT (OPTICAL)] jack on your TV and the Digital Audio Input on the Home Theatre.

When following the connection above, the Optical jack only outputs 2 channel audio. You will only hear sound from the

Home Theatre's Front Left and Right speakers and the subwoofer. If you want to hear 5.1 channel audio, connect the [DIGITAL AUDIO OUT (OPTICAL)] jack on the DVD / Satellite Box (ie Anynet Device 1) directly to the Amplifier or Home Theatre, not the TV.

Connect only one Home Theatre.

Some HDMI cables may not support <Anynet+> functions.

<Anynet+> works when the AV device supporting <Anynet+> is in the Standby or On status.

<Anynet+> supports up to 10 AV devices in total. Note that you can connect up to 3 devices of the same type.

Setting Up Anynet+

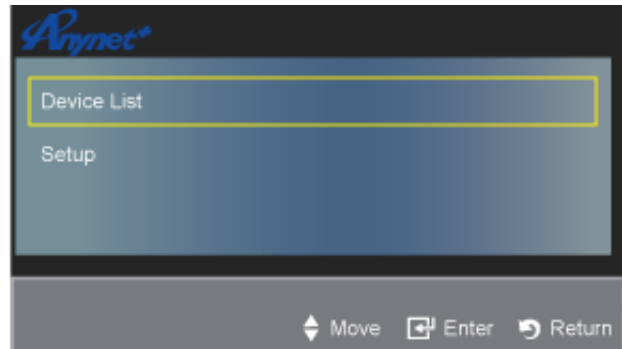
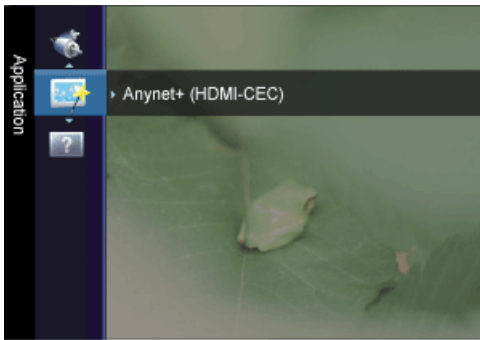

Press the [TOOLS] button to display the <Tools> menu. You can also display the <Anynet+> menu by selecting <Tools> → <Anynet+ (HDMI-CEC)>

Setup

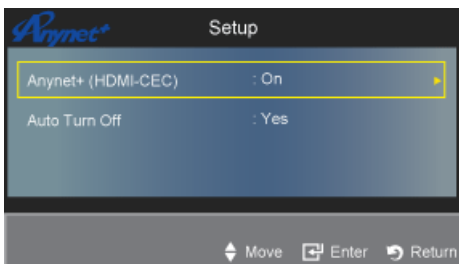

- <Anynet+ (HDMI-CEC)>
To use the <Anynet+> Function, <Anynet+ (HDMI-CEC)> must be set to On.
 - When the <Anynet+ (HDMI-CEC)> function is disabled, all the <Anynet+> related operations are deactivated.
- <Auto Turn Off>
Setting an <Anynet+> Device to turn Off automatically when the TV is turned off.
 - The active source on the TV remote must be set to TV to use the <Anynet+> function.
If you set Auto Turn Off to Yes, connected external devices are also turned off when the TV is turned off. If an external device is still recording, it may or may not turn off.

Device List

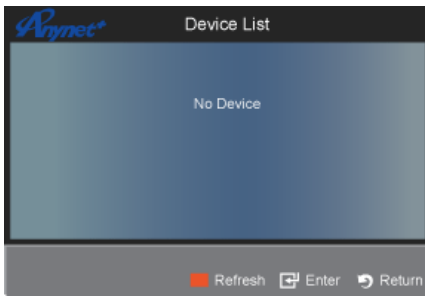

1. Press the **[TOOLS]** button. Press the **[↔]** button to select <Anynet+ (HDMI-CEC)>.
2. Press the **▲** or **▼** button to select <Device List>, then press the **[↔]** button.
 - <Anynet+> devices connected to the TV are listed.
 - If you cannot find a device you want, press the red button to scan for devices.
3. Press the **▲** or **▼** button to select a particular device and press the **[↔]** button. It is switched to the selected device.
 - <Anynet+ (HDMI-CEC)> must be set to On in the <Application> menu for the <Device List> menu to appear.

 Switching to the selected devices may take up to 2 minutes. You cannot cancel the operation during the switching operation.

The time required to scan for devices is determined by the number of connected devices.



When the device scan is complete, the number of devices found are not displayed.

Although the TV automatically searches the device list when the TV is turned on via the power button, devices connected to the TV may not always be automatically displayed in the device list. Press the red button to search for the connected device.

If you have selected external input mode by pressing the **[SOURCE]** button, you cannot use the <Anynet+> function. Make sure to switch to an <Anynet+> device by using the <Device List>.

Support



| MENU | DESCRIPTION |
|------------------|---|
| Self Diagnosis | <ul style="list-style-type: none"> • <Picture Test> If you think you have a picture problem, perform the picture test. Check the colour pattern on the screen to see if the problem still exists. <ul style="list-style-type: none"> • <Yes> : If the test pattern does not appear or there is noise in the test pattern, select <Yes>. There may be a problem with the TV. Contact Samsung's call centre for assistance. • <No> : If the test pattern is properly displayed, select <No>. There may be a problem with your external equipment. Please check your connections. If the problem still persists, refer to the external device's user manual. • <Sound Test> If you think you have a sound problem, please perform the sound test. You can check the sound by playing a built-in melody sound through the TV. <ul style="list-style-type: none"> • <Yes> : If during the sound test you can hear sound only from one speaker or not at all, select <Yes>. There may be a problem with the TV. Contact Samsung's call centre for assistance. • <No> : If you can hear sound from the speakers, select <No>. There may be a problem with your external equipment. Please check your connections. If the problem still persists, refer to the external device's user manual. <ul style="list-style-type: none">  • If you hear no sound from the TV's speakers, before performing the sound test, make sure <Speaker Select> is set to <TV speaker> in the <Sound> menu. • The melody will be heard during the test even if <Speaker Select> is set to <External Speaker> or the sound is muted by pressing the [MUTE] button. • <Signal Information>(digital channels only) Unlike analogue channels, which can vary in reception quality from snowy to clear, digital (HDTV) channels have either perfect reception quality or you will not receive them at all. So, unlike analogue channels, you cannot fine tune a digital channel. You can, however, adjust your antenna to improve the reception of available digital channels. <ul style="list-style-type: none">  If the signal strength meter indicates that the signal is weak, physically adjust your antenna to increase the signal strength. Continue to adjust the antenna until you find the best position with the strongest signal. |
| Software Upgrade | <ul style="list-style-type: none"> • <By USB> Insert a USB drive containing the firmware upgrade downloaded from samsung.com into the TV. Please be careful not to disconnect the power or remove the USB drive while upgrades are being applied. The TV will turn off and turn on automatically after completing the firmware upgrade. Please check the firmware version after the upgrades are complete (the new version will have a higher number than the older version). When software is upgraded, video and audio settings you have made will return to their default (factory) settings. We recommend you write down your settings so that you can easily reset them after the upgrade. • <By Channel> Upgrades the software using the broadcasting signal. • <Standby Mode Upgrade> To continue software upgrade with master power on, select on by pressing the ▲ or ▼ button. 45 minutes after entering standby mode, a manual upgrade is automatically conducted. Since the power of the unit is turned on internally, the screen may be on slightly for the LED product. This phenomenon may continue for more than 1 hour until the software upgrade is completed. • <Alternative Software>(Backup) If there is an issue with the new firmware and it is affecting operation, you can change the software to the previous version. <ul style="list-style-type: none">  • If software was changed, existing software is displayed. • You can change current software to alternative software by '<Alternative Software>'. |

| MENU | DESCRIPTION |
|---------------------|--|
| HD Connection Guide | This menu presents the connection method that provides the optimal quality for the HDTV. Refer to this information when connecting external devices to the TV. |
| Contact Samsung | View this information when your TV does not work properly or when you want to upgrade the software. You can view the information regarding the call centre, product and software file download method. |

3-6 Installing the Device Driver

 If you install the device driver, you can set up the appropriate resolution and frequency for the product. The device driver is included on the CD supplied with the product. If the supplied drive file is corrupted, please visit the Samsung Electronics website (www.samsung.com), and download the driver.

1. Insert the driver installation CD into the CD-ROM drive.
2. Click on Windows Driver.
3. Complete the remaining installation steps according to the instructions displayed on the screen.
4. Select the model of your product from the model list.

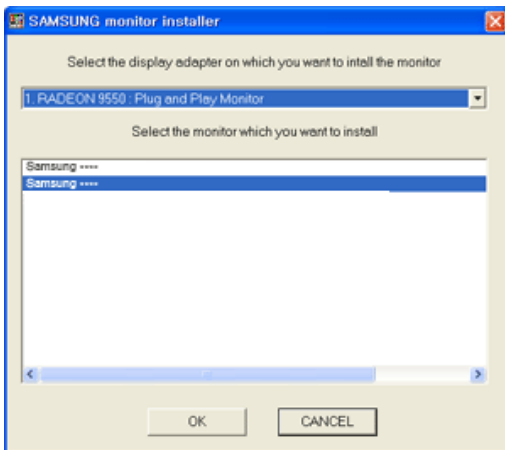

5. Check if the appropriate resolution and screen refresh rate are displayed in the Control Panel settings. For more information, refer to the document about the Windows operating system.

3-7 Standard Signal Mode Table

- An LCD monitor has one optimal resolution for the best visual quality depending on the screen size due to the inherent characteristics of the panel, unlike a CDT monitor.

Therefore, the visual quality will be degraded if the optimal resolution is not set for the panel size. It is recommended setting the resolution to the optimal resolution of the product.

PC Timing (D-Sub and HDMI input)

If the signal from the PC is one of the following standard signal modes, the screen is set automatically. However, if the signal from the PC is not one of the following signal modes, a blank screen may be displayed or only the Power LED may be turned on. Therefore, configure it as follows referring to the User Manual of the graphics card.

| RESOLUTION | HORIZONTAL FREQUENCY (KHZ) | VERTICAL FREQUENCY (HZ) | CLOCK FREQUENCY (MHZ) | POLARITY (H/V) |
|-------------------|----------------------------|-------------------------|-----------------------|----------------|
| IBM, 640 x 350 | 31.469 | 70.086 | 25.175 | +/- |
| IBM, 640 x 480 | 31.469 | 59.940 | 25.175 | -/- |
| IBM, 720 x 400 | 31.469 | 70.087 | 28.322 | -/+ |
| MAC, 640 x 480 | 35.000 | 66.667 | 30.240 | -/- |
| MAC, 832 x 624 | 49.726 | 74.551 | 57.284 | -/- |
| MAC, 1152 x 870 | 68.681 | 75.062 | 100.000 | -/- |
| VESA, 640 x 480 | 37.861 | 72.809 | 31.500 | -/- |
| VESA, 640 x 480 | 37.500 | 75.000 | 31.500 | -/- |
| VESA, 800 x 600 | 35.156 | 56.250 | 36.000 | +/+ |
| VESA, 800 x 600 | 37.879 | 60.317 | 40.000 | +/+ |
| VESA, 800 x 600 | 48.077 | 72.188 | 50.000 | +/+ |
| VESA, 800 x 600 | 46.875 | 75.000 | 49.500 | +/+ |
| VESA, 1024 x 768 | 48.363 | 60.004 | 65.000 | -/- |
| VESA, 1024 x 768 | 56.476 | 70.069 | 75.000 | -/- |
| VESA, 1024 x 768 | 60.023 | 75.029 | 78.750 | +/+ |
| VESA, 1152 x 864 | 67.500 | 75.000 | 108.000 | +/+ |
| VESA, 1280 X 800 | 49.702 | 59.810 | 83.500 | -/+ |
| VESA, 1280 X 960 | 60.000 | 60.000 | 108.000 | +/+ |
| VESA, 1280 X 1024 | 63.981 | 60.020 | 108.000 | +/+ |
| VESA, 1280 X 1024 | 79.976 | 75.025 | 135.000 | +/+ |
| VESA, 1440 x 900 | 55.935 | 59.887 | 106.500 | -/+ |
| VESA, 1600 x 1200 | 75.000 | 60.000 | 162.000 | +/+ |
| VESA, 1680 x 1050 | 65.290 | 59.954 | 146.250 | -/+ |
| VESA, 1920 x 1080 | 67.500 | 60.000 | 148.500 | +/+ |

Horizontal Frequency

The time taken to scan one line from the left-most position to the right-most position on the screen is called the horizontal cycle and the reciprocal of the horizontal cycle is called the horizontal frequency. The horizontal frequency is represented in kHz.

Vertical Frequency

A panel must display the same picture on the screen tens of times every second so that humans can see the picture. This frequency is called the vertical frequency. The vertical frequency is represented in Hz.

4 Installing the Software

4-1 Natural Color

What is Natural Color ?

This software is for Samsung products only and enables you to adjust the displayed colors on the product so they more closely match the colors of printed pictures. For more information, refer to the online help of the software (F1).

Natural Color is provided online. You can download it from the website below and install;



http://www.samsung.com/us/consumer/learningresources/monitor/naturalcolorexpert/pop_download.html

What is MultiScreen ?



MultiScreen enables you to partition multiple sections on the Monitor.

Installing the Software

1. Insert the installation CD into the CD-ROM drive.
2. Select the MultiScreen setup programme.
 -  If the pop-up screen for the software installation does not appear on the main screen, find and double-click the MultiScreen setup file on the CD-ROM.
3. When the Installation Wizard appears, click [Next].
4. Complete the remaining software installation steps according to the instructions displayed on the screen.
 - 
 - The software may not work properly if you do not restart the computer after the installation.
 - The MultiScreen icon may not appear depending on the computer system and the product specifications.
 - If the shortcut icon does not appear, press the F5 key.

MultiScreen Installation Requirements

The MultiScreen installation may be affected by the graphics card, motherboard and the networking environment.

Operating System

OS

- Windows 2000
- Windows XP Home Edition
- Windows XP Professional
- Windows Vista
- Windows 7 32Bit

 For MultiScreen, Windows 2000 or later operating systems are recommended.

Hardware

- At least 32MB of memory
- At least 60MB of free space on the hard disk drive

Removing the Software

Click [Start], select [Settings]/[Control Panel], and then double-click [Add or Remove programmes].

Select MultiScreen from the programme list and click the [Add/Delete] button.

5 Troubleshooting

5-1 Monitor Self-Diagnosis

- You can check if the product is working properly using the Self-Diagnosis function.
- If a blank screen is displayed and the Power LED blinks even if the product and the PC are properly connected, perform the self-diagnosis function according to the procedures below.

1. Turn the product and the PC off.
2. Remove the D-Sub cable from the product.
3. Turn the product on.
4. If the product is working properly, the '<Check Signal Cable >' message appears.
In this case, if a blank screen is displayed again, make sure that there is no problem with the PC and the connection.

5-2 Before Requesting Service

-  Please check the following before requesting After-Sales service. If the problem continues, please contact your nearest Samsung Electronics Service Centre.

| PROBLEMS RELATED TO INSTALLATION (PC MODE) | |
|---|--|
| The monitor screen flickers. | Check if the signal cable between the computer and the monitor is securely connected and tightened. (Refer to Connecting to a Computer) |
| PROBLEMS RELATED TO SCREEN | |
| Screen is blank and power indicator is off. | Ensure that the power cord is firmly connected and the LCD monitor is on. (Refer to Connecting to a Computer) |
| "Check Signal Cable" message | Ensure that the signal cable is firmly connected to the PC or video sources. (Refer to Connecting to a Computer) |
| "Not Optimum Mode" message | Check the maximum resolution and the frequency of the video adapter. Compare these values with the data in the Standard Signal Mode Table. |
| Picture rolls vertically. | Check if the signal cable is securely connected. Connect it again securely. (Refer to Connecting to a Computer) |
| Image is not clear. Picture is blurred. | Run Frequency <Coarse> and <Fine> tuning. Turn on again after removing all accessories (video extension cable, etc.) Set resolution and frequency to the recommended ranges. |
| Picture image is unstable and vibrates. | Check if the resolution and frequency set for the computer video card falls in the range supported by the monitor. If not, reset them referring to the current <Information> under the monitor menu and Standard Signal Mode Table. |
| Ghost images are shown in the picture. | |
| The image is too light or too dark | Adjust the Brightness and Contrast (Refer to the <Brightness>, <Contrast>) |
| Screen is blank and the power indicator light blinks every 0.5 or 1 seconds | The monitor is using its power management system Press a key on the keyboard |
| The screen is blank and is blinking. | If you see the TEST GOOD message on the screen when you press the [MENU] button, check the cable connection between the monitor and the computer to ensure that the connector is properly connected. |
| PROBLEMS RELATED TO AUDIO | |
| No sound | Ensure that the audio cable is firmly connected to both the audio-in port on your monitor and the audio-out port on your sound card. (Refer to Connecting to a Computer) Check the volume level. |
| The sound level is too low. | Check the volume level. If the volume is still too low after turning the control to its maximum, check the volume control on the computer sound card or software programme. |
| PROBLEMS RELATED TO REMOTE CONTROL | |
| The remote control buttons do not respond. | Check the battery polarities (+/-). Check if the batteries have been exhausted. Check if the power is on. Check if the power cord is securely connected. Check if a special fluorescent or neon lamp is on in the vicinity |

NOTE ON THE PRODUCT APPEARANCE

You may see small particles if you look closely at the edge of the bezel surrounding the screen.

This is part of the product's design and is not a defect.

| FAQ | PLEASE TRY THE FOLLOWING! |
|---|--|
| How can I change the frequency of the video signal? | <p>You have to change the frequency of the graphics card.</p> <p>(For more information, refer to the User Manual of the computer or the graphics card.)</p> |
| How can I change the resolution? | <p>Windows XP: Change the resolution by selecting Control Panel → Appearance and Themes → Display → Settings.</p> <p>Windows ME/2000 : Change the resolution by selecting Control Panel → Appearance and Themes → Display → Settings.</p> <p>Windows 7 : Change the resolution by selecting Control Panel → Appearance and Personalization → Display → Adjust resolution.</p> <p>(For more information, refer to the User Manual of the computer or the graphics card.)</p> |
| How can I use the power saving function? | <p>Windows XP: Configure it by selecting Control Panel → Appearance and Themes → Display → Screen Saver Setting or configure it in the BIOS SETUP of the computer.</p> <p>Windows ME/2000 : Configure it by selecting Control Panel → Appearance and Themes → Display → Screen Saver Setting or configure it in the BIOS SETUP of the computer.</p> <p>Windows 7 : Change settings by selecting Control Panel → Appearance and Personalization → Personalization → Screen Saver. You can also use the BIOS SETUP menu on the PC.</p> <p>For more information, refer to the Windows user manual for the computer.</p> |
| How can I clean the outer case/LCD Panel? | <p>Disconnect the power cord and then clean the monitor with a soft cloth, using either a plain water.</p> <p>Do not leave any detergent or scratches on the case.</p> <p>Do not let any water enter the monitor.</p> |
| Can I watch digital TV broadcasting with an analogue TV? | <p>No.</p> <p>The analogue TV cannot interpret digital signals. Therefore, a digital TV is required to watch digital TV broadcasting.</p> |
| Can I use my present antenna to receive digital broadcasting? | <p>As for existing analogue TV, digital TV is designed so that digital broadcasting signals are received via both indoor and outdoor antennas.</p> <p>If signal reception is very good in your environment, you can watch digital broadcasts with your existing indoor antenna. If not, it is better to install an outdoor antenna.</p> |

6 More Information

6-1 Specifications

| MODEL NAME | | XL2270HD | XL2370HD |
|---|----------------------|---|--|
| LCD Panel | Screen Size | 21.53 inches (54 cm) | 23 inch (58 cm) |
| | Display Area | 476.64 mm (H) X 268.11 mm (V)(18.77 inch X 10.56 inch) | 509.76 mm (H) X 286.74 mm (V)(20.07 inch X 11.29 inch) |
| | Pixel Pitch | 0.24825 mm (H) X 0.24825 mm (V)(0.01 inch X 0.01 inch) | 0.2655 mm (H) X 0.2655 mm (V)(0.01 inch X 0.01 inch) |
| Synchronization | Horizontal Frequency | 30 ~ 81 kHz | |
| | Vertical Frequency | 56 ~ 75 Hz | |
| Colour | | 16.7M | |
| Resolution | Optimal Resolution | 1920 x 1080 @ 60 Hz | |
| | Maximum Resolution | 1920 x 1080 @ 60 Hz | |
| Input Signal, Terminated | | RGB analogue, DVI (Digital Visual Interface) 0.7 Vp-p ± 5 % Separate Type H/V Sync, Composite TTL Level (V high ≥ 2.0 V, V low ≤ 0.8 V) | |
| Maximum Pixel Clock | | 162.000 MHz (Analogue, Digital) | |
| Power Voltage | | This product supports 100 – 240 V. Since the standard voltage may differ from country to country, please check the label on the back of the product. | |
| Dimension (Width x Height x Depth) / Weight | | 536.3 x 345.2 x 66.1 mm (21.1 x 13.6 x 2.6 inch) (Without Stand) / 4.4 kg (9.7 lbs) 536.3 x 403.0 x 189.5 mm (21.1 x 15.9 x 7.5) inch (With Stand) / 4.8 kg (10.6 lbs) | 571.0 x 364.6 x 65.5 mm (22.5 x 14.4 x 2.6 inch) (Without Stand) / 4.8 kg (10.6 lbs) 571.0 x 432.5 x 189.5 mm (22.5 x 17.0 x 7.5) inch (With Stand) / 5.2 kg (11.5 lbs) |
| VESA Mounting Interface | | 75 mm x 75 mm (2.95 x 2.95 inch) | |
| Environmental considerations | Operating | Temperature : 50°F ~ 104°F (10°C ~ 40°C) Humidity : 10 % ~ 80 %, non-condensing | |
| | Storage | Temperature : -4°F ~ 113°F (-20°C ~ 45°C) Humidity : 5 % ~ 95 %, non-condensing | |

 **Class B (Information Communication Equipment for Home Use)**

This device has been registered regarding EMI for home use (Class B). It may be used in all areas. (Class B equipment emits less electromagnetic waves than Class A equipment.)

6-2 Power Saving Function

This product provides a power saving function that automatically turns the screen off when the product is not used for a predetermined period of time to reduce power consumption. If the product enters power saving mode, the power LED turns to a different colour to indicate that the product is in power saving mode.

When the product is in power saving mode, the power is not turned off and you can turn the screen on again by pressing any key or clicking the mouse. However, the power saving function only works when the product is connected to a computer that provides the power saving function.

| POWER SAVING FUNCTION | NORMAL OPERATION | POWER SAVING MODE DPM(DISPLAY POWER MANAGEMENT) | POWER OFF (POWER BUTTON) |
|-----------------------|---------------------|---|-----------------------------|
| Power LED | On | Blinks | Off |
| Power Consumption | XL2270HD : 38 watts | Less than 2 watts | Less than 1 watts |
| | XL2370HD : 38 watts | | |

- If there is no power cut-off switch, the power consumption is "0" only when the power cord is disconnected.
- DPM(Display Power Management) Function does not work if you used in conjunction with the HDMI port of this product.

6-3 Contact SAMSUNG WORLDWIDE

 If you have any questions or comments relating to Samsung products, please contact the SAMSUNG customer care centre.

| EUROPE | | |
|-------------|---|---|
| AUSTRIA | 0810 - SAMSUNG(7267864,€ 0.07/min) | http://www.samsung.com |
| BELGIUM | 02-201-24-18 | http://www.samsung.com/be (Dutch) http://www.samsung.com/be_fr (French) |
| CZECH | 800 - SAMSUNG (800-726786) | http://www.samsung.com |
| | Distributor pro Českou republiku: Samsung Zrt., česká organizační složka, Oasis Florenc, Sokolovská394/17, 180 00, Praha 8 | |
| DENMARK | 70 70 19 70 | http://www.samsung.com |
| EIRE | 0818 717100 | http://www.samsung.com |
| ESTONIA | 800-7267 | http://www.samsung.com |
| FINLAND | 030 - 6227 515 | http://www.samsung.com |
| FRANCE | 01 48 63 00 00 | http://www.samsung.com |
| GERMANY | 01805 - SAMSUNG (726-7864,€ 0,14/Min) | http://www.samsung.com |
| HUNGARY | 06-80-SAMSUNG(726-7864) | http://www.samsung.com |
| ITALIA | 800-SAMSUNG(726-7864) | http://www.samsung.com |
| LATVIA | 8000-7267 | http://www.samsung.com |
| LITHUANIA | 8-800-77777 | http://www.samsung.com |
| LUXEMBURG | 261 03 710 | http://www.samsung.com |
| NETHERLANDS | 0900 - SAMSUNG (0900-7267864) (€ 0,10/Min) | http://www.samsung.com |
| NORWAY | 815-56 480 | http://www.samsung.com |
| POLAND | 0 801 1SAMSUNG (172678) 022 - 607 - 93 - 33 | http://www.samsung.com |
| PORTUGAL | 80820 - SAMSUNG (726-7864) | http://www.samsung.com |
| SLOVAKIA | 0800-SAMSUNG(726-7864) | http://www.samsung.com |
| SPAIN | 902 - 1 - SAMSUNG (902 172 678) | http://www.samsung.com |
| SWEDEN | 0771 726 7864 (SAMSUNG) | http://www.samsung.com |
| SWITZERLAND | 0848-SAMSUNG(7267864, CHF 0.08/min) | http://www.samsung.com/ch http://www.samsung.com/ch_fr (French) |
| U.K | 0845 SAMSUNG (7267864) | http://www.samsung.com |
| CIS | | |
| ARMENIA | 0-800-05-555 | |
| AZERBAIJAN | 088-55-55-555 | |
| BELARUS | 810-800-500-55-500 | |
| GEORGIA | 8-800-555-555 | |

| CIS | | |
|-------------|---------------------|--|
| KAZAKHSTAN | 8-10-800-500-55-500 | |
| KYRGYZSTAN | 00-800-500-55-500 | http://www.samsung.com |
| MOLDOVA | 00-800-500-55-500 | |
| RUSSIA | 8-800-555-55-55 | http://www.samsung.com |
| TADJIKISTAN | 8-10-800-500-55-500 | http://www.samsung.com |
| UKRAINE | 0-800-502-000 | http://www.samsung.com/ua http://www.samsung.com/ua_ru |
| UZBEKISTAN | 8-10-800-500-55-500 | http://www.samsung.com |

6-4 Correct Disposal

CORRECT DISPOSAL OF THIS PRODUCT (WASTE ELECTRICAL & ELECTRONIC EQUIPMENT) - EUROPE ONLY



(Applicable in the European Union and other European countries with separate collection systems)

This marking on the product, accessories or literature indicates that the product and its electronic accessories (e.g. charger, headset, USB cable) should not be disposed of with other household waste at the end of their working life. To prevent possible harm to the environment or human health from uncontrolled waste disposal, please separate these items from other types of waste and recycle them responsibly to promote the sustainable reuse of material resources.

Household users should contact either the retailer where they purchased this product, or their local government office, for details of where and how they can take these items for environmentally safe recycling.

Business users should contact their supplier and check the terms and conditions of the purchase contract. This product and its electronic accessories should not be mixed with other commercial wastes for disposal.

CORRECT DISPOSAL OF BATTERIES IN THIS PRODUCT - EUROPE ONLY



(Applicable in the European Union and other European countries with separate battery return systems.)

This marking on the battery, manual or packaging indicates that the batteries in this product should not be disposed of with other household waste at the end of their working life. Where marked, the chemical symbols Hg, Cd or Pb indicate that the battery contains mercury, cadmium or lead above the reference levels in EC Directive 2006/66. If batteries are not properly disposed of, these substances can cause harm to human health or the environment.

To protect natural resources and to promote material reuse, please separate batteries from other types of waste and recycle them through your local, free battery return system.

-  The rechargeable battery incorporated in this product is not user replaceable. For information on its replacement, please contact your service provider.