

FOR PERFECT RESULTS

Thank you for choosing this AEG product. We have created it to give you impeccable performance for many years, with innovative technologies that help make life simpler – features you might not find on ordinary appliances. Please spend a few minutes reading to get the very best from it.

ACCESSORIES AND CONSUMABLES

In the AEG webshop, you'll find everything you need to keep all your AEG appliances looking spotless and working perfectly. Along with a wide range of accessories designed and built to the high quality standards you would expect, from specialist cookware to cutlery baskets, from bottle holders to delicate laundry bags...



Visit the webshop at:
www.aeg-electrolux.com/shop

CONTENTS

4	Safety information
8	Product description
9	Before first use
10	Hob - Daily Use
10	Hob - Helpful hints and tips
11	Hob - Care and Cleaning
12	Oven - Daily Use
13	Oven - Helpful hints and tips
20	Oven - Care and Cleaning
24	What to do if...
24	Installation
25	Environment concerns

The following symbols are used in this user manual:



Important information concerning your personal safety and information on how to avoid damaging the appliance.



General information and tips



Environmental information

Subject to change without notice



SAFETY INFORMATION

Before the installation and use, read this manual carefully:

- For your own safety and the safety of your property
- For the protection of the environment
- For the correct operation of the appliance.

Always keep these instructions with the appliance also if you move or sell it.

The manufacturer is not responsible if incorrect installation or use results in damage.

Children and vulnerable people safety

- This appliance can be used by children aged from 8 years and above and persons with reduced physical, sensory or mental capabilities or lack of experience and knowledge if they have been given supervision or instruction concerning use of the appliance in safe way and understand the hazards involved. Children shall not play with the appliance.
- Keep all packaging away from children. There is the risk of suffocation or physical injury.
- Keep children and animals away from the appliance when the door is open or the appliance is in operation. There is the risk of injury or other permanent disability.
- If the appliance has Child lock or Key lock function, use it. It prevents children and animals from accidental operation of the appliance.

General safety

- Do not change the specifications of this appliance. There is the risk of injury and damage to the appliance.
- Do not let the appliance stay unattended during operation.
- Switch off the appliance after each use.

Installation

- Only an approved technician can install and connect the appliance. Contact an approved service centre. This is to prevent the risks of structural damage or physical injury.
- Make sure that the appliance is not damaged because of transport. Do not connect a damaged appliance. If necessary, contact the supplier.
- Remove all packaging, stickers and layers from the appliance before first use. Do not remove the rating plate. It can invalidate the guarantee.
- Fully obey the laws, ordinances, directives and standards in force in the country where you use the appliance (safety regulations, recycling regulations, electrical or gas safety rules etc.).
- Be careful when you move the appliance. The appliance is heavy. Always use safety gloves. Do not pull the appliance by the handle.
- Make sure that the appliance is disconnected from the power supply during the installation (if applicable).
- Keep the minimum distances to the other appliances and units.
- Do not put the appliance on a base.

Electrical connection

- Only an approved electrician can install and connect the appliance. Contact an approved service centre. This is to prevent the risks of structural damage or physical injury.
- The appliance must be earthed.
- Make sure that the electrical data on the rating plate agree with your domestic power supply.
- Information on the voltage is on the rating plate.
- You must have the correct isolation devices: line protecting cut-outs, fuses (screw type fuses removed from the holder), earth leakage trips and contactors.
- The electrical installation must have an isolation device which lets you disconnect the appliance from the mains at all poles. The isolation device must have a contact opening width of minimum 3 mm.
- The shock protection parts must be fixed in such a way that they cannot be undone without tools.
- Always use a correctly installed shockproof socket.
- When you connect electrical appliances to mains sockets, do not let cables touch or come near the hot appliance door.
- Do not use multi-way plugs, connectors and extension cables. There is a risk of fire.
- Make sure not to squash or cause damage to the mains plug (if applicable) and cable behind the appliance.
- Make sure that the mains connection is accessible after the installation.
- Do not pull the mains cable to disconnect the appliance. Always pull the mains plug (if applicable).
- Do not replace or change the mains cable. Contact the service centre.

Use

- Only use the appliance for domestic cooking tasks. Do not use the appliance for commercial and industrial use. This is to prevent physical injury to persons or prevent damage to property.
- Always monitor the appliance during operation.
- Always stay away from the appliance when you open the door while the appliance is in operation. Hot steam can release. There is a risk of burns.
- Do not use this appliance if it is in contact with water. Do not operate the appliance with wet hands.
- Do not use the appliance as a work surface or storage surface.
- The cooking surface of the appliance becomes hot during use. There is a risk of burns. Do not put metallic objects, for example cutlery or saucepans lids, on the surface, as they can become hot.
- The interior of the appliance becomes hot during use. There is a risk of burns. Use gloves when you insert or remove the accessories or pots.
- Open the door carefully. The use of ingredients with alcohol can cause a mixture of alcohol and air. There is the risk of fire.
- Do not let sparks or open flames come near the appliance when you open the door.

- Do not put flammable products or items that are wet with flammable products, and/or fusible objects (made of plastic or aluminium) in, near or on the appliance. There is a risk of explosion or fire.
- Set the cooking zones to "off" after each use.
- Do not use the cooking zones with empty cookware or without cookware
- Do not let cookware boil dry. This can cause damage to the cookware and hob surface.
- If an object or cookware falls on the hob surface, the surface can be damaged.
- Do not put hot cookware near to the control panel because the heat can cause a damage to the appliance.
- Be careful when you remove or install the accessories to prevent damage to the appliance enamel.
- Cookware made of cast iron, cast aluminium or with damaged bottoms can scratch the hob surface if you move them on the surface.
- Discoloration of the enamel has no effect on the performance of the appliance.
- To prevent damage or discoloration to the enamel:
 - do not put any objects directly on the appliance floor and do not cover it with aluminium foil;
 - do not put hot water directly into the appliance;
 - do not keep moist dishes and food in the appliance after you finish the cooking.
- Do not apply pressure on the open door.
- Do not put flammable materials in the compartment below the oven. Keep there only heat-resistant accessories (if applicable).
- Do not cover oven steam outlets. They are at the rear side of the top surface (if applicable).
- If there is a crack on the surface, disconnect the power supply. There is a risk of electric shock.
- Do not put heat-conducting materials (e.g. thin metal mesh or metal-plated heat conductors) under the cookware. Excessive heat reflection can damage the cooking surface.
- Do not use the appliance during a power cut.

Care and cleaning

- Before maintenance, make sure that the appliance is cold. There is a risk of burns. There is a risk that the glass panels can break.
- Keep the appliance clean at all times. A build-up of fats or other foodstuff can result in a fire.
- Regular cleaning prevents the surface material from deteriorating.
- For your personal safety and the safety of your property, only clean the appliance with water and soap. Do not use flammable products or products that can cause corrosion.
- Do not clean the appliance with steam cleaners, high-pressure cleaners, sharp objects, abrasive cleaning agents, abrasive sponges and stain removers.
- If you use an oven spray, follow the instructions from the manufacturer. Do not spray anything on the heating elements and the thermostat sensor.

- Do not clean the glass door with abrasive cleaning agents or metal scraper. Heat resistant surface of the inner glass can break and shatter.
- When the door glass panels are damaged they become weak and can break. You must replace them. Contact the service centre.
- Be careful when you remove the door from the appliance. The door is heavy.
- Bulb lamps used in this appliance are special lamps selected for household appliances use only. They cannot be used for the full or partial illumination of a household room.
- If it becomes necessary to replace the lamp use one of the same power and specifically designed for household appliances only.
- Disconnect the appliance from the power supply before the replacement of the oven lamp. There is the risk of electrical shock. Cool down the appliance. There is a risk of burns.

Service centre

- Only an approved engineer can repair or work on the appliance. Contact an approved service centre.
- Use only original spare parts.

Disposal of the appliance

- To prevent the risk of physical injury or damage:
 - Disconnect the appliance from the power supply.
 - Cut off the mains cable and discard it.
 - Discard the door catch. This prevents children or small animals from being closed inside of the appliance. There is a risk of suffocation.

PRODUCT DESCRIPTION

General overview

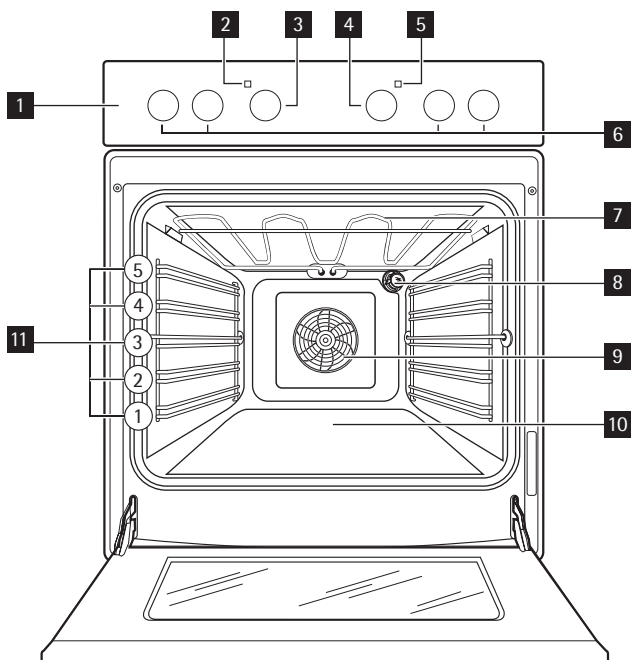

- 1** Control panel
- 2** Oven power indicator
- 3** Knob for the oven functions
- 4** Knob for the temperature
- 5** Temperature indicator
- 6** Knobs for the hob
- 7** Heating element
- 8** Oven lamp
- 9** Fan
- 10** Bottom heat
- 11** Shelf supports

Cooking surface layout

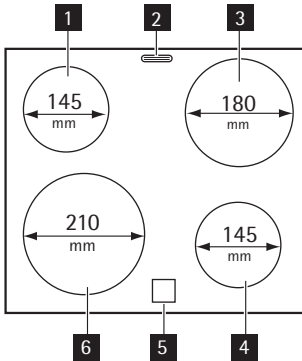

- 1** Cooking zone 1200W
- 2** Steam outlet
- 3** Cooking zone 1800W
- 4** Cooking zone 1200W
- 5** Residual heat indicator
- 6** Cooking zone 2300W

Oven accessories

- Oven shelf
For cookware, cake tins, roasts.
- Flat baking tray
For cakes and biscuits.
- Storage drawer
Below the oven cavity is the storage drawer.



WARNING!

The storage drawer can become hot when the appliance operates.

BEFORE FIRST USE



Remove all packaging, both inside and outside the oven, before using the appliance. Do not remove the rating plate.



CAUTION!

To open the oven door, always hold the handle in the centre.

Initial Cleaning

- Remove all parts from the appliance.
- Clean the appliance before first use.



CAUTION!

Do not use abrasive cleaning agents! This can damage the surface. Refer to chapter "Care and Cleaning".

Preheating

1. Set function  and maximum temperature.
2. Run an empty oven for 45 minutes.

3. Set function  and maximum temperature.

4. Run an empty oven for 15 minutes.

This is to burn off any residue from the cavity surface. Accessories can become more hot than in normal use. During this period an odour and smoke can be emitted. This is normal. Make sure the airflow is sufficient.

HOB - DAILY USE

Heat settings

Control knob	Function
0	Off position
1-9	Heat settings (1 = lowest heat setting; 9= highest heat setting)

1. Turn the control knob to a necessary heat setting.
2. To complete the cooking process, turn the control knob to the "0" position.

Residual heat indicator

The residual heat indicator comes on when a cooking zone is hot.



WARNING!

Risk of burns from residual heat!

HOB - HELPFUL HINTS AND TIPS

Cookware



- The bottom of the cookware must be as thick and flat as possible.
- Cookware made of enamelled steel and with aluminium or copper bottoms can cause discoloration on glass ceramic surface.

Examples of cooking applications

The data in the table is for guidance only.

Heat setting	Use to:	Time	Hints
1	Keep cooked foods warm	as re-quired	Cover
1-2	Hollandaise sauce, melt: butter, chocolate, gelatine	5-25 min	Mix occasionally
1-2	Solidify: fluffy omelettes, baked eggs	10-40 min	Cook with a lid on
2-3	Simmer rice and milkbased dishes, heating up ready-cooked meals	25-50 min	Add at least twice as much liquid as rice, stir milk dishes part way through

Heat setting	Use to:	Time	Hints
3-4	Steam vegetables, fish, meat	20-45 min	Add a few tablespoons of liquid
4-5	Steam potatoes	20-60 min	Use max. ¼ l water for 750 g of potatoes
4-5	Cook larger quantities of food, stews and soups	60-150 min	Up to 3 l liquid plus ingredients
6-7	Gentle fry: escalope, veal cordon bleu, cutlets, rissoles, sausages, liver, roux, eggs, pancakes, doughnuts	as required	Turn halfway through
7-8	Heavy fry, hash browns, loin steaks, steaks	5-15 min	Turn halfway through
9	Boil large quantities of water, cook pasta, sear meat (goulash, pot roast), deep fry chips		

Energy saving



- If possible, always put the lids on the cookware.
- Put cookware on a cooking zone before you start it.
- Stop the cooking zones before the end of the cooking time to use residual heat.
- The bottom of pans and cooking zones must have the same dimension.

HOB – CARE AND CLEANING

Clean the appliance after each use.
Always use cookware with clean bottom.



Scratches or dark stains on the glass ceramic have no effect on how the appliance operates.

To remove the dirt:









1. – **Remove immediately:** melted plastic, plastic foil, and food with sugar. If not, the dirt can cause damage to the appliance. Use a special scraper for the glass. Put the scraper on the glass surface at an acute angle and move the blade on the surface.
 - **Remove after the appliance is sufficiently cool:** limescale rings, water rings, fat stains, shiny metallic discolorations. Use a special cleaning agent for glass ceramic or stainless steel.
2. Clean the appliance with a moist cloth and some detergent.
3. At the end **rub the appliance dry with a clean cloth.**
 - Clean the front of the appliance with a soft cloth and a solution of hot water and some detergent.
 - For metal fronts use some detergent for stainless steel.
 - Do not use scouring agents and abrasive sponges.

OVEN - DAILY USE

Activating and deactivating the appliance

1. Turn the knob for the oven functions to an oven function.
2. Turn the knob for the temperature to a temperature.
The power indicator comes on while the appliance operates.
The temperature indicator comes on while the temperature in the appliance increases.
3. To deactivate the appliance, turn the knob for the oven functions and the knob for the temperature to the Off position.

Oven Functions

	Oven function	Application
	OFF position	The appliance is OFF.
	LIGHT	Use this function to light up the oven interior.
	FAN-ASSISTED CIRCULATION	To bake on a maximum of two oven levels at the same time. Set the oven temperatures (20-40°C) lower than for Conventional. To dry food.
	CONVENTIONAL	To bake and roast on one oven level.
	BASE HEAT	To bake cakes with crispy or crusty bases and to preserve food.
	DEFROST	To defrost frozen food.
	SINGLE GRILL	To grill flat food items in the middle of the grill and to toast.
	DUAL GRILL	To grill flat food items in large quantities and to toast.
	ROTITHERM	To roast larger joints of meat or poultry on one level. Also to gratinate.

Inserting the Oven Accessories

Put in the slide-in accessories so that the double side edges are at the back of the oven and point down to the bottom. Push the slide-in accessories between the guide-bars of one of the oven levels.

- i** The oven shelf has double side edges. These edges and the shape of the guide-bars causes the anti-tilt safety for the oven accessories.

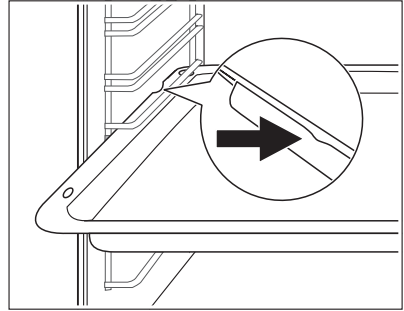

OVEN - HELPFUL HINTS AND TIPS

- !** **WARNING!**
Refer to "Safety information" chapter.

- i** The temperature and baking times in the tables are guidelines only. They depend on the recipes, quality and quantity of the ingredients used.

Baking

General instructions

- Your new oven may bake or roast differently to the appliance you had before. Adapt your usual settings (temperature, cooking times) and shelf levels to the values in the tables.
- With longer baking times, the oven can be switched off about 10 minutes before the end of baking time, to use the residual heat.

When you use frozen food, the trays in the oven can twist during baking. When the trays get cold again, the distortion will be gone.

How to use the Baking Tables











- We recommend to use the lower temperature the first time.
- If you cannot find the settings for a special recipe, look for the one that is almost the same.
- Baking time can be extended by 10-15 minutes, if you bake cakes on more than one level.
- Cakes and pastries at different heights do not always brown equally at first. If this occurs, do not change the temperature setting. The differences equalize during the baking procedure.

Tips on baking

Baking results	Possible cause	Remedy
The cake is not browned sufficiently below	Incorrect oven level	Put the cake on a lower oven level

Baking results	Possible cause	Remedy
The cake sinks (becomes soggy, lumpy, streaky)	Oven temperature too high	Use a lower setting
The cake sinks (becomes soggy, lumpy, streaky)	Baking time is too short	Set a longer baking time Do not set higher temperatures to decrease baking times
The cake sinks (becomes soggy, lumpy, streaky)	Too much liquid in the mixture	Use less liquid. Look at the mixing times, specially when you use mixing machines
Cake is too dry	Oven temperature too low	Set a higher oven temperature
Cake is too dry	Baking time too long	Set a shorter baking time
Cake does not brown equally	Oven temperature too high and baking time too short	Set a lower oven temperature and a longer baking time
Cake does not brown equally	No equal mixture	Put the mixture equally on the baking tray
Cake does not cook in the baking time set	Temperature too low	Use a slightly higher oven temperature setting

Baking on one oven level - Baking in tins

Type of baking	Oven function	Level	Temperature (°C)	Time (h:min)
Ring cake or brioche	 Fan assisted circulation	1	150 - 160	0:50 - 1:10
Madeira cake/Fruit cakes	 Fan assisted circulation	1	140 - 160	1:10 - 1:30
Sponge cake	 Fan assisted circulation	1	140	0:25 - 0:40
Sponge cake	 CONVENTIONAL	1	160	0:25 - 0:40
Flan base - short pastry ¹⁾	 Fan assisted circulation	3	170-180	0:10 - 0:25
Flan base - sponge mixture	 Fan assisted circulation	3	150 - 170	0:20 - 0:25
Apple pie	 CONVENTIONAL	1	170 - 190	0:50 - 1:00
Apple pie (2 tins, Ø 20 cm, diagonally off set)	 Fan assisted circulation	1	160	1:10 - 1:30
Apple pie (2 tins, Ø 20 cm, diagonally off set)	 CONVENTIONAL	1	180	1:10 - 1:30
Savoury flan (e.g. quiche lorraine)	 Fan assisted circulation	1	160 - 180	0:30 - 1:10
Curd Cheese Cake	 CONVENTIONAL	1	170 - 190	1:00 - 1:30

1) Pre-heat oven

Baking on one oven level - Cakes/pastries/breads on baking trays

Type of baking	Oven function	Level	Temperature (°C)	Time (h:min)	
Plaited bread/bread crown	☐	CONVENTIONAL	3	170 - 190	0:30 - 0:40
Christmas stollen ¹⁾	☐	CONVENTIONAL	3	160 - 180	0:40 - 1:00
Bread (rye bread)	☐	CONVENTIONAL	1		
- first of all ¹⁾			230		0:25
- then			160 - 180		0:30 - 1:00
Cream puffs/eclairs ¹⁾	☐	CONVENTIONAL	3	160 - 170	0:15 - 0:30
Swiss roll ¹⁾	☐	CONVENTIONAL	3	180 - 200	0:10 - 0:20
Cake with crumble topping (dry)	☒	Fan assisted circulation	3	150 - 160	0:20 - 0:40
Buttered almond cake/sugar cakes ¹⁾	☐	CONVENTIONAL	3	190 - 210	0:15 - 0:30
Fruit flans (made with yeast dough / sponge mixture) ²⁾	☒	Fan assisted circulation	3	150	0:35 - 0:50
Fruit flans (made with yeast dough / sponge mixture) ²⁾	☐	CONVENTIONAL	3	170	0:35 - 0:50
Fruit flans made with short pastry	☒	Fan assisted circulation	3	160 - 170	0:40 - 1:20
Yeast cakes with delicate toppings (e.g. quark, cream, custard) ¹⁾	☐	CONVENTIONAL	3	160 - 180	0:40 - 1:20
Pizza (with a lot of topping) ¹⁾²⁾	☒	Fan assisted circulation	1	180 - 200	0:30 - 1:00
Pizza (thin crust) ¹⁾	☒	Fan assisted circulation	1	200 - 220	0:10 - 0:25
Unleavened bread	☒	Fan assisted circulation	1	200 - 200	0:08 - 0:15
Tarts (CH)	☒	Fan assisted circulation	1	180 - 200	0:35 - 0:50

1) Pre-heat oven

2) Use the deep roasting pan

Baking on one oven level - Biscuits

Type of baking	Oven function	Level	Temperature (°C)	Time (h:min)	
Short pastry biscuits		Fan assisted circulation	3	150 - 160	0:06 - 0:20
Viennese whirls		Fan assisted circulation	3	140	0:20 - 0:30
Viennese whirls ¹⁾		CONVENTIONAL	3	160	0:20 - 0:30
Biscuits made with sponge mixture		Fan assisted circulation	3	150 - 160	0:15 - 0:20
Pastries made with egg white, meringues		Fan assisted circulation	3	80 - 100	2:00 - 2:30
Macaroons		Fan assisted circulation	3	100 - 120	0:30 - 0:60
Biscuits made with yeast dough		Fan assisted circulation	3	150 - 160	0:20 - 0:40
Puff pastries ¹⁾		Fan assisted circulation	3	170 - 180	0:20 - 0:30
Rolls ¹⁾		Fan assisted circulation	3	160	0:20 - 0:35
Rolls ¹⁾		CONVENTIONAL	3	180	0:20 - 0:35
Small cakes (20 per tray) ¹⁾		Fan assisted circulation	3	140	0:20 - 0:30
Small cakes (20 per tray) ¹⁾		CONVENTIONAL	3	170	0:20 - 0:30

1) Pre-heat oven

Roasting 

Roasting dishes

- Use heat-resistant ovenware to roast (please read the instructions of the manufacturer).
- Large roasting joints can be roasted directly in the deep roasting pan or on the oven shelf above the deep roasting pan. (If present)
- Roast lean meats in a roasting tin with a lid. This will keep the meat more succulent.
- All types of meat, that can be browned or have crackling, can be roasted in the roasting tin without the lid.

Beef

Type of meat	Quantity	Oven function	Shelf level	Temperature °C	Time (h:min)
Port roast	1 - 1,5 kg		1	200 - 250	2:00 - 2:30
Roast beef or fillet					for each cm of thickness

Type of meat	Quantity	Oven function	Shelf level	Temperature °C	Time (h:min)
- rare ¹⁾	for each cm of thickness		1	190 - 200	0:05 - 0:06
- medium	for each cm of thickness		1	180 - 190	0:06 - 0:08
- well done	for each cm of thickness		1	170 - 180	0:08 - 0:10

1) preheat the oven

Pork

Type of meat	Quantity	Oven function	Shelf level	Temperature °C	Time (h:min)
Shoulder, neck, ham joint	1 - 1.5 kg		1	160 - 180	1:30 - 2:00
Chop, spare rib	1 - 1.5 kg		1	170 - 180	1:00 - 1:30
Meat loaf	750 g - 1 kg		1	160 - 170	0:45 - 1:00
Porkknuckle (precooked)	750 g - 1 kg		1	150 - 170	1:30 - 2:00

Veal

Type of meat	Quantity	Oven function	Shelf level	Temperature °C	Time (h:min)
Roast Veal	1 kg		1	160 - 180	1:30 - 2:00
Knuckle of veal	1,5 -2 kg		1	160 - 180	2:00 - 2:30

Lamb

Type of meat	Quantity	Oven function	Shelf level	Temperature °C	Time (h:min)
Leg of lamb, roast lamb	1 - 1,5 kg		1	150 - 170	1:15 - 2:00
Saddle of lamb	1 - 1,5 kg		1	160 - 180	1:00 - 1:30

Game

Type of meat	Quantity	Oven function	Shelf level	Temperature °C	Time (h:min)
Saddle of hare, leg of hare ¹⁾	up to 1 kg		3	220 - 250	0:25 - 0:40
Saddle of venison	1,5 - 2 kg		1	210 - 220	1:15 - 1:45
Haunch of venison	1,5 - 2 kg		1	200 - 210	1:30 - 2:15

1) preheat the oven

Poultry

Type of meat	Quantity	Oven function	Shelf level	Temperature °C	Time (h:min)
Poultry portions	200 - 250 g each		1	200 - 220	0:35 - 0:50

Type of meat	Quantity	Oven function	Shelf level	Temperature °C	Time (h:min)
Half chicken	400 - 500 g each		1	190 - 210	0:35 - 0:50
chicken, poulard	1 - 1,5 kg		1	190 - 210	0:45 - 1:15
Duck	1.5 - 2 kg		1	180 - 200	1:15 - 1:45
Goose	3.5 - 5 kg		1	160 - 180	2:30 - 3:30
Turkey	2.5 - 3.5 kg		1	160 - 180	1:45 - 2:30
Turkey	4 - 6 kg		1	140 - 160	2:30 - 4:00

Fish (steamed)

Type of meat	Quantity	Oven function	Shelf level	Temperature °C	Time (h:min)
Whole fish	1 - 1,5 kg		1	210 - 220	0:45 - 1:15

Grilling

Always use the grilling function with maximum temperature setting



Always grill with the oven door closed



Always pre-heat the empty oven with the grill functions for 5 minutes.

- Set the shelf in the shelf level as recommended in the grilling table.
- Always set the pan to collect the fat into the first shelf level.
- Grill only flat pieces of meat or fish.



To see which oven function you must use please refer to the oven functions list in Daily use chapter.

Food to grill	Shelf level	Time	
		1st side	2nd side
Burgers	4	8 - 10 mins.	6 - 8 mins.
Pork fillet	4	10 - 12 mins.	6 - 10 mins.
Sausages	4	8 - 10 mins.	6 - 8 mins.
Filet steaks, veal steaks	4	6 - 7 mins	5 - 6 mins.
Filet of beef, roast beef (approximately 1 kg)	3	10 - 12 mins.	10 - 12 mins.
Toast ¹⁾	3	4 - 6 mins.	3 - 5 mins.
Toast with topping	3	6 - 8 mins.	-----

1) Do not pre-heat

Defrosting

- Put the food out of the packaging and set it on a plate on the oven shelf.

- Do not cover with a plate or bowl. This can extend the time to defrost very much.
- Put the oven shelf in the first shelf level from the bottom.



To see which oven function you must use please refer to the oven functions list in Daily use chapter.

Dish	Defrosting time (mins)	Further defrosting time (mins)	Comments
Chicken, 1000 g	100-140	20-30	Place the chicken on an upturned saucer placed on a large plate Turn halfway through
Meat, 1000 g	100-140	20-30	Turn halfway through
Meat, 500 g	90-120	20-30	Turn halfway through
Trout, 150g	25-35	10-15	-----
Strawberries, 300g	30-40	10-20	-----
Butter, 250g	30-40	10-15	-----
Cream, 2 x 200g	80-100	10-15	Cream can also be whipped when still slightly frozen in places
Gateau, 1400g	60	60	-----

Preserving

- Only use usual preserving jars of the same dimension.
- Do not use jars with twist-off or bayonet type lids and metal tins.
- Use the first shelf level from the bottom.
- Use the baking tray. You can put six 1-litre jars maximum on it.
- Fill all the jars to the same level and close them correctly.
- Put the jars on the shelf, make sure that they do not touch each other.
- Fill approximately 1/2 litre of water into the flat baking tray to have sufficient moisture in the oven.
- When the liquid lightly starts to bubble in the first jars (after about 35-60 minutes with 1 litre jars), switch off the oven or decrease the temperature to 100°C (see table).



To see which oven function you must use please refer to the oven functions list in Daily use chapter.

Soft fruit

Preserve	Temperature in °C	Time until simmering in mins.	Continue to cook at 100°C in mins.
Strawberries, blueberries, raspberries, ripe gooseberries	160 - 170	35 - 45	---
Unripe gooseberries	160 - 170	35 - 45	10 - 15

Stone fruit

Preserve	Temperature in °C	Time until simmering in mins.	Continue to cook at 100°C in mins.
Pears, quinces, plums	160 - 170	35 - 45	10 - 15

Vegetables

Preserve	Temperature in °C	Time until simmering in mins.	Continue to cook at 100°C in mins.
Carrots ¹⁾	160 - 170	50 - 60	5 - 10
Cucumbers	160 - 170	50 - 60	---
Mixed pickles	160 - 170	50 - 60	15
Kohlrabi, peas, asparagus	160 - 170	50 - 60	15 - 20

1) Leave standing in oven when switched off

Information on acrylamides

Important! According to the newest scientific knowledge, if you brown food (specially the one which contains starch), acrylamides can pose a health risk. Thus, we recommend that you cook at the lowest temperatures and do not brown food too much.

OVEN - CARE AND CLEANING

- Clean the front of the appliance with a soft cloth with warm water and cleaning agent.
- To clean metal surfaces use a usual cleaning agent
- Clean the oven interior after each use. Thus you can remove dirt more easily and it does not burn on.
- Clean stubborn dirt with a special oven cleaner.
- Clean all oven accessories (with a soft cloth with warm water and cleaning agent) after each use and let them dry.
- If you have nonstick accessories, do not clean them using an aggressive agents, sharp edged objects or dishwasher. It can destroy nonstick coating!

Shelf Support Rails

Removing the shelf support rails

1. Pull the front of the shelf support rail away from the side wall.

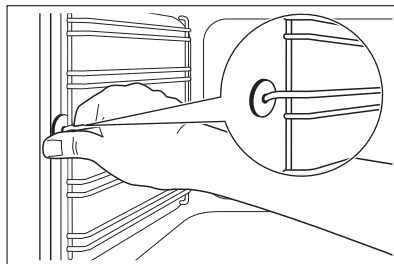

2. Pull the rear shelf support rail away from the side wall and remove it.

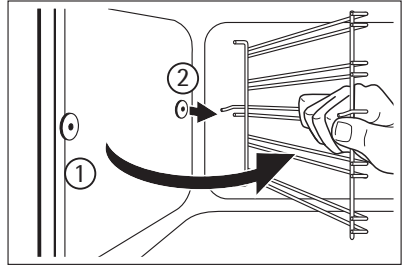

Installing the shelf support rails

Install the shelf support rails in opposite sequence.



Important! The rounded ends of the shelf support rails must point to the front!

Oven door and glass panels

To clean the oven door remove it.



CAUTION!

Be careful when you remove the door from the appliance. The door is heavy!

Removing the oven door

1. Open the oven door as far as it goes.
2. Lift up clamping levers (A) on the two door hinges fully.

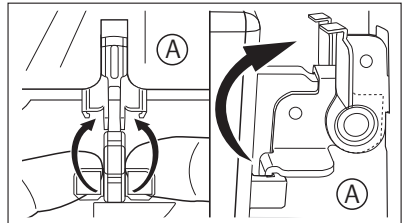

3. Close the oven door until the first position (angle approximately 45°).
4. Hold of the oven door with one hand on each side and pull it away from the oven at an upwards angle.
5. Now you can remove the inner glass panels and clean them.

To install the door follow the procedure in reverse.

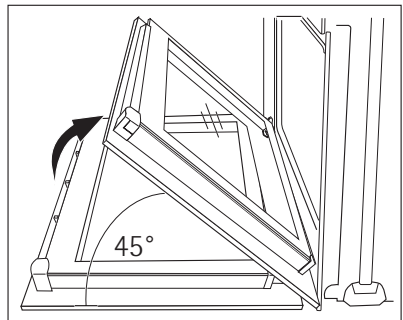

CAUTION!

Be careful with the glass, it can break.



The oven door has 2, 3 or 4 panels of glass (depends on the model)

i Put the oven door with the outer side down on a soft and level surface to prevent scratches

Removing and cleaning the door glasses

1. Hold the door trim (B) on the top edge of the door at the two sides and push inwards to release the clip seal.

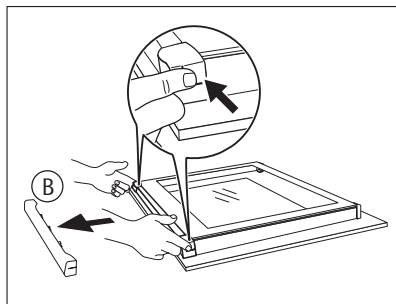

2. Pull the door trim to the front to remove it.

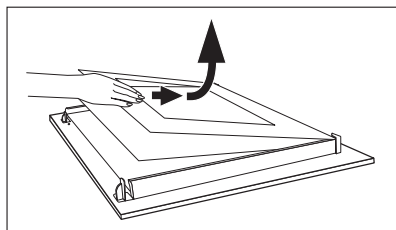

3. Hold the door glass panels on their top edge one by one and pull them upwards out of the guide
4. Clean the door glass panels.

To install panels follow the procedure in reverse. Insert the smaller panel first, then the larger.

Oven Ceiling

You can fold down the heating element on the oven ceiling to clean the oven ceiling easily.



WARNING!

Before you fold down the heating element switch off the appliance. Make sure that the appliance is cold.

There is a risk of burns!

Folding down the heating element

1. Remove the shelf support rails.
2. Hold the heating element with the two hands at the front
3. Pull it forwards against the spring pressure and out along the support on both sides.
4. The heating element folds down.
The oven ceiling is ready to clean.

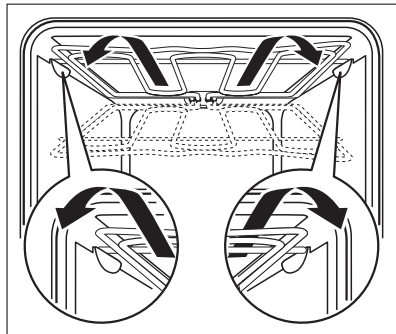

Installing the heating element

1. Install the heating element in opposite sequence.



Install the heating element correctly on the two sides above the support on the inner wall of the oven.

2. Insert shelf support rails.

Removing the drawer

The drawer underneath the oven can be removed for easier cleaning.

Removing the drawer

1. Pull the drawer out as far as possible.
2. Lift the drawer slightly, so that can be lifted upwards at an angle of the drawer guides.

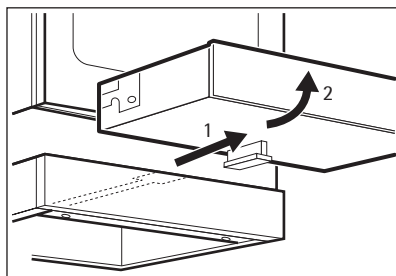

Inserting the drawer

1. Set the drawer on the drawer's support rails. Make sure that drawer's middle guide engages into the middle rail.
2. Lower the drawer to the horizontal and push it in.



WARNING!

When the oven is in use, heat can build up in the drawer. For this reason, do not keep flammable things in there such as e.g. cleaning materials, plastic bags, oven gloves, paper, cleaning sprays, etc.

Oven lamp



WARNING!

There is a danger of electrical shock!

Before you change the oven lamp:

- Switch off the oven.
- Remove the fuses in the fuse box or switch off the circuit breaker.



Put a cloth on the bottom of the oven for protection of the oven light and glass cover.

Replacing the oven light bulb/cleaning the glass cover

1. Turn the glass cover anti-clockwise to remove it.
2. Clean the glass cover.
3. Replace the oven light bulb with applicable 300°C heat-resistant oven light bulb.
4. Install the glass cover.

WHAT TO DO IF...

Problem	Possible cause	Remedy
The residual heat indicators does not come on	The cooking zone is not hot because it operated only for a short time	If the cooking zone must be hot, speak to the after sales service
The appliance does not operate	The fuse in the fuse box is released	Control the fuse. If the fuse is released more than one time, refer to a qualified electrician.
The oven does not heat up	The oven is not switched on	Switch on the oven
The oven does not heat up	The necessary settings are not set	Control the settings
The oven lamp does not operate	The oven lamp is defective	Replace the oven lamp
Steam and condensation settle on the food and in the oven cavity	You left the dish in the oven for too long	Do not leave the dishes in the oven for longer than 15-20 minutes after the cooking process ends

If you cannot find a solution to the problem yourself, contact your dealer or the service centre.

The necessary data for the service centre is on the rating plate. The rating plate is on the front frame of the oven cavity.

We recommend that you write the data here:

Model (MOD.)

Product number (PNC)

Serial number (S.N.)

INSTALLATION



First read "Safety information" chapter carefully.

Technical Data

Appliance class 2, sub class 1 and class 1.

Dimensions	
Height	850 mm
Width	600 mm
Depth	600 mm
Oven capacity	58 l



WARNING!

Do not set the appliance on a base

Levelling

Use small feet on the bottom of appliance to set same level of cooker top surface with other surfaces

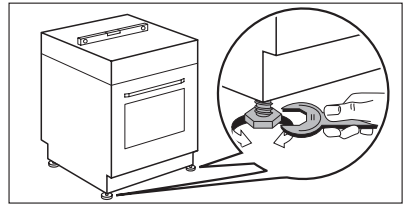

Electrical installation



WARNING!

Only a qualified and competent person must do the electrical installation.



The manufacturer is not responsible if you do not follow safety precautions from chapter "Safety".

This appliance is supplied without a main plug and a main cable.

Applicable cable types : H07 RN-F, H05 RN-F, H05 RRF, H05 VV-F, H05 V2V2-F (T90), H05 BB-F

ENVIRONMENT CONCERNS

The symbol  on the product or on its packaging indicates that this product may not be treated as household waste. Instead it should be taken to the appropriate collection point for the recycling of electrical and electronic equipment. By ensuring this product is disposed of correctly, you will help prevent potential negative consequences for the environment and human health, which could otherwise be caused by inappropriate waste handling of this product. For more detailed information about recycling of this product, please contact your local council, your household waste disposal service or the shop where you purchased the product.



Packaging material

The packaging material is environmentally-friendly and recyclable. Plastic parts are marked with international abbreviations such as PE, PS, etc. Dispose of the packaging material in the containers provided for this purpose at your local waste management facility.



WARNING!

Your appliance should be made inoperable before it is disposed of, so that it does not constitute a danger.

To do this, take the mains plug from the socket and remove the mains cable from the appliance.

www.aeg-electrolux.com/shop

892941204-A-422010

