



**REQUIRED TOOLS
AND MATERIALS:**

 • Two (2) Capable Adults

 • Tape Measure

 • Safety Glasses

 • Stepladder 8 ft.
(2.4m)

• (2 each) Wrenches

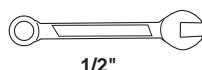

1/2"

AND/OR

• Socket Wrenches and Sockets
(Deep-Well Sockets are Recommended).

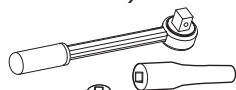

1/2"

**OPTIONAL TOOLS
AND MATERIALS:**

• Large & Small Adjustable
Wrenches

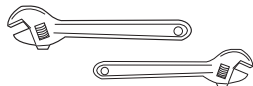

Standard Rim Owners Manual

Customer Service Center

• N53 W24700 South Corporate Circle • Sussex, WI 53089 • U.S.A.

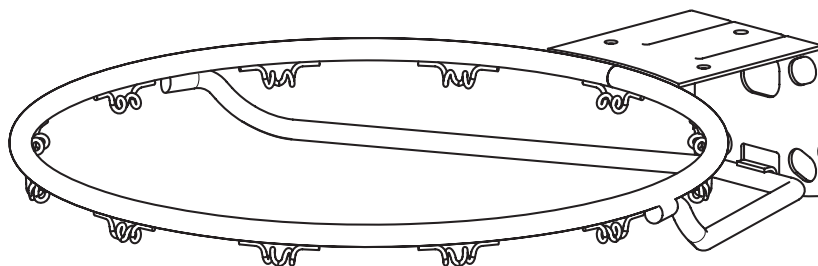

Adult Assembly Required.

This manual, accompanied by sales receipt, should be saved and kept on hand as a convenient reference, as it contains important information about your model.

	! WARNING!
	READ AND UNDERSTAND OPERATOR'S MANUAL BEFORE USING THIS UNIT. FAILURE TO FOLLOW OPERATING INSTRUCTIONS COULD RESULT IN INJURY OR DAMAGE TO PROPERTY.

**Write Model Number
From Box Here:**

Toll-Free Customer Service Number for U.S: 1-800-558-5234,

For Canada: 1-800-284-8339,

For Europe: 00 800 555 85234 (Sweden: 009 555 85234),

For Australia: 1800 632 792

Internet Address: www.huffysports.com www.spalding.com



SAFETY INSTRUCTIONS



FAILURE TO FOLLOW THESE SAFETY INSTRUCTIONS MAY RESULT IN SERIOUS INJURY OR PROPERTY DAMAGE AND WILL VOID WARRANTY.

Owner must ensure that all players know and follow these rules for safe operation of the system.

To ensure safety, do not attempt to assemble this system without following the instructions carefully. Check entire box and inside all packing material for parts and/or additional instruction material. Before beginning assembly, read the instructions and identify parts using the hardware identifier and parts list in this document. Proper and complete assembly, use, and supervision are essential for proper operation and to reduce the risk of accident or injury. A high probability of serious injury exists if this system is not installed, maintained, and operated properly.

- If using a ladder during assembly, use extreme caution.
- Two (2) capable adults are recommended for this operation.
- Climate, corrosion, or misuse could result in system failure.
- Minimum operational height is 7'6" (2.3 m) to the bottom of backboard.
- This equipment is intended for home recreational use only and NOT excessive competitive play.
- Read and understand the warning label enclosed with hardware. It is the responsibility of the customer to mount this label. It should be affixed to the pole, wall, or door near playing area, at a height between 4-6 feet (1.22-1.83M) above ground level and in a location visible to all players
- The life of your basketball pole depends on many conditions. The climate, placement of the pole, the location of the pole, exposure to corrosives such as pesticides, herbicides or salts are all important factors.
- If technical assistance is required contact Customer Service.
- Serious injury could occur if teeth/face come in contact with backboard, net or rim.
- Adult supervision is recommended when adjusting height.

*Most injuries are caused by misuse and/or not following instructions.
Use caution when using this system.*



WARNING

Read and understand warnings listed below before using this product.

Failure to follow these warnings may result in serious injury and/or property damage.

Owner must ensure that all players know and follow these rules for safe operation of the system.

- DO NOT HANG on the rim or any part of the system including backboard, support braces or net.
- During play, especially when performing dunk type activities, keep player's face away from the backboard, rim and net. Serious injury could occur if teeth/face come in contact with backboard, rim or net.
- During play, do not wear jewelry (rings, watches, necklaces, etc.). Objects may entangle in net.
- Check system before each use for loose hardware, excessive wear and signs corrosion and repair before use.
- Never play on damaged equipment.
- See instruction manual for proper installation and maintenance.

SPALDING
In the U.S.: 1-800-558-5234
In Canada: 1-800-284-8339

HYDRA-RIB
In the U.S.: 1-800-334-9111

RUSSELL
ATHLETIC

SURESHOT
In the U.S.: 1-888-713-5488

HUFFYSPORTS
In the U.S.: 1-800-558-5234
In Canada: 1-800-284-8339

ID#: 579800 05/05



Questions or Missing Parts?

DON'T go back to store!

Call TOLL-FREE Customer Service
Number listed on the front page!

NOTICE TO ASSEMBLERS

Adult Assembly Required. Dispose of ALL packaging materials promptly. As with all products, periodically inspect for loose small parts.

ALL basketball systems, including those used for DISPLAYS, MUST be assembled and installed according to instructions. Failure to follow instructions could result in SERIOUS INJURY. It is NOT acceptable to devise a makeshift support system.

IMPORTANT!

**Remove all contents from boxes.
Be sure to check inside pole sections;
hardware and additional parts are packed inside.**

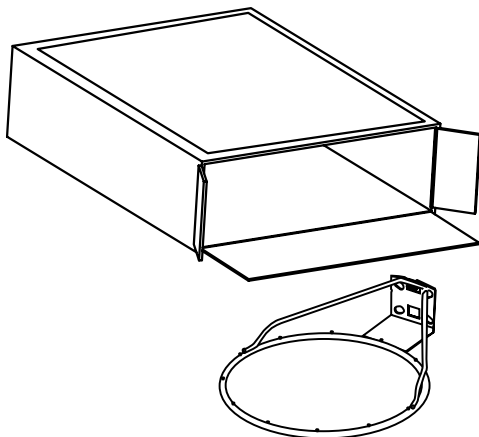

PRODUCT REGISTRATION:

Please remember to complete your product registration form on-line at:
www.huffysports.com/customer_support/product_registration.

For more information on assembly, placement, proper use, and maintenance, visit The American Basketball Council website at <http://www.smarthoops.com>.

PARTS LIST

<input checked="" type="checkbox"/>	<u>Item</u>	<u>Qty.</u>	<u>Part No.</u>	<u>Description</u>
<input type="checkbox"/>	1	1	579800	Warning Label
<input type="checkbox"/>	2	4	201611	Hex Flange Bolt 5/16-18 x 3 Long
		4	203113	Hex Flange Bolt 5/16-18 x 2-1/2" Long
		4	203104	Hex Flange Bolt 5/16-18 x 2" Long
		4	205528	Hex Flange Bolt 5/16-18 x 1" Long
<input type="checkbox"/>	3	4*	203309	Washer, 1 O.D.
<input type="checkbox"/>	4	4	203100	Hex Flange Nut, 5/16 x 18
<input type="checkbox"/>	5	1		Rim
<input type="checkbox"/>	6	1		Net

* QUANTITY USED MAY VARY BY MOUNTING METHOD.

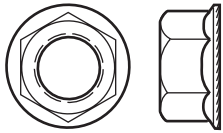

Item #4 (4)*

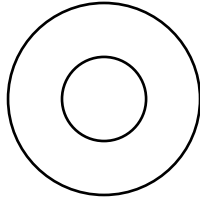

Item #3 (4)

RIM TO BOARD BOLTS

(This kit will only include 4 of one of the bolts listed below):

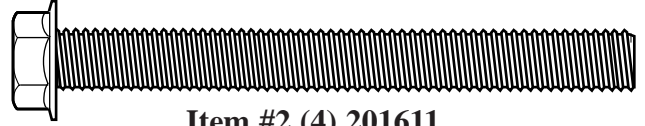

Item #2 (4) 201611

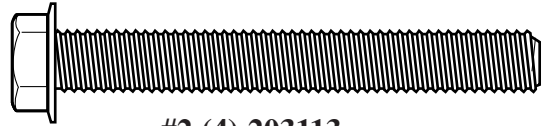

#2 (4) 203113

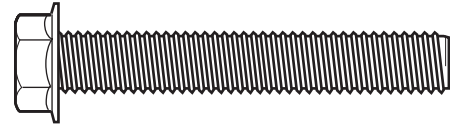

#2 (4) 203104

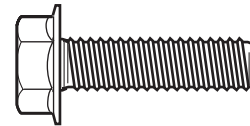

#2 (4) 205528

1.

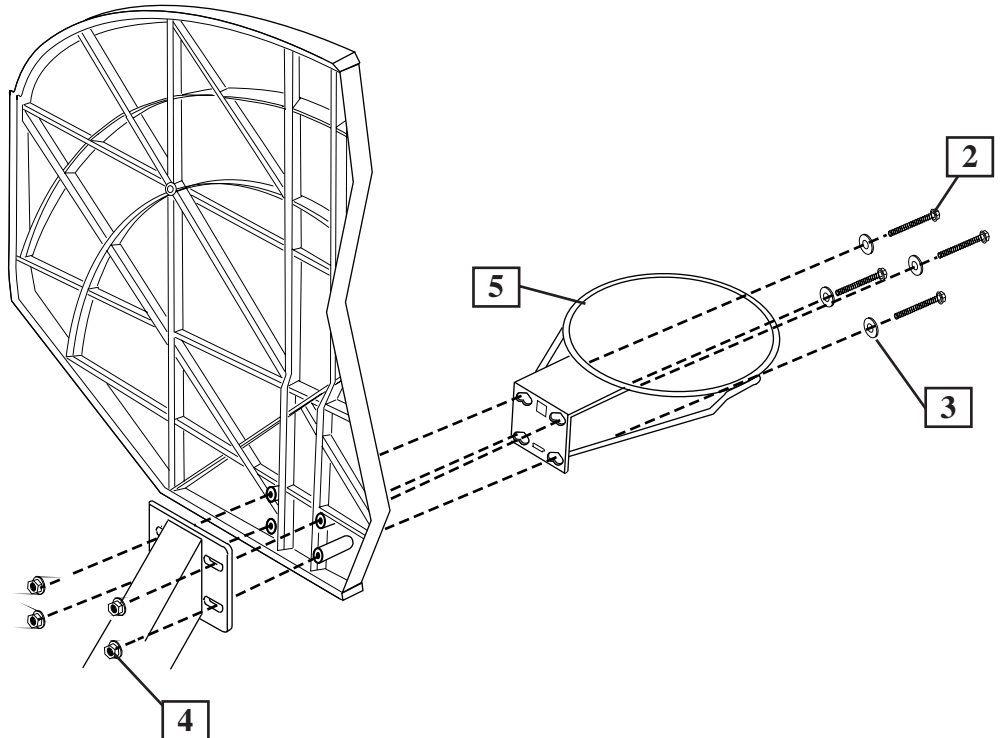

2. Install net (6).

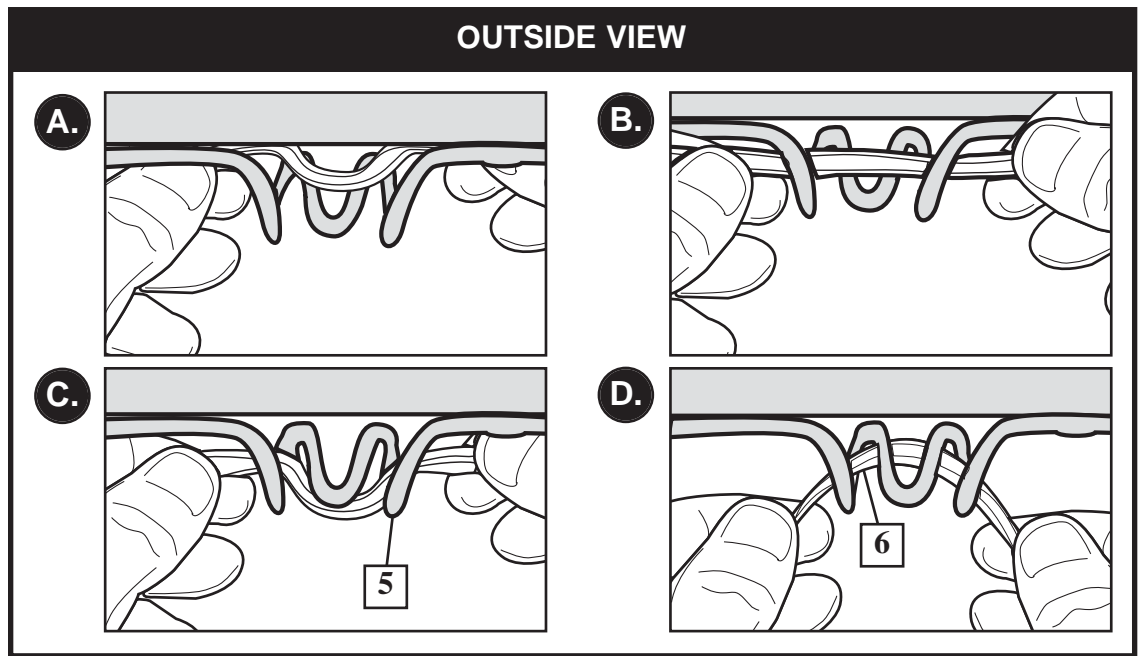

3. Place warning label (1) in location clearly visible within playing area.

