



# LCD MONITOR

## quick start guide

320MX 320MXn

---

---

# Introduction

## Package Contents



Please make sure the following items are included with your LCD Display.

If any items are missing, contact your dealer.

Contact a local dealer to buy optional items.



This stand is not for the Floor Standing Type.

## Unpacking



LCD Display

### Manuals



Quick Setup Guide



Warranty Card



User's Guide

(Not available in all locations)

### Cables



D-Sub Cable



Power Cord

### Others



**Others**

Remote Control

Batteries (AAA X 2)

(Not available in all locations)

**Sold separately**

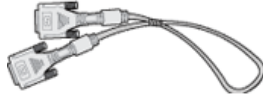

DVI Cable

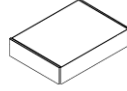

Wall Mount KIT



LAN Cable

(Applicable to the MXn model only)

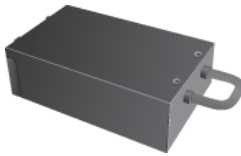

TV tuner box



NetWork Box



Semi Stand KIT

(Applicable to the MX model only)

 **Note**

- You can purchase and connect a separate network box or TV tuner box. For information on how to use these, refer to their respective user manuals.
- You can only connect one external box.

**Your LCD Display**

**Front**

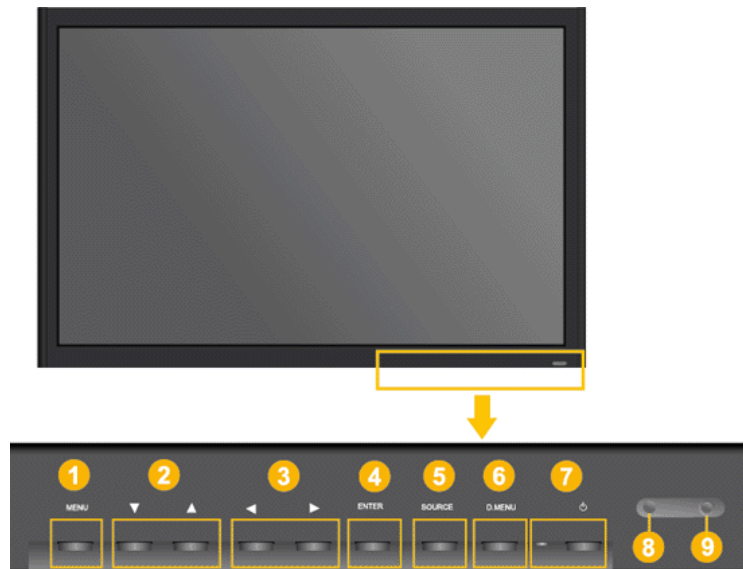

① MENU button [MENU]

Opens the on-screen menu and exits from the menu. Also use to exit the OSD menu or return to the previous menu.

**2** *Navigate buttons (Up-Down buttons)*

Moves from one menu item to another vertically or adjusts selected menu values.

**3** *Adjust buttons (Left-Right buttons) / Volume buttons*

Moves from one menu item to another horizontally or adjusts selected menu values. When OSD is not on the screen, push the button to adjust volume.

**4** *ENTER button [ENTER]*

Activates a highlighted menu item.

**5** *SOURCE button [SOURCE]*

Switches from PC mode to Video mode. Changing the source is only allowed for external devices that are connected to the LCD Display at the time.

[PC] → [DVI] → [AV] → [HDMI] → [MagicInfo] → [TV]



**Note**

- The **TV** menu is available when a TV tuner box is installed.
- The MagicInfo menu is available when a network box is installed in the MXn or MX model.

**6** *D.MENU*

Opens the on-screen D.MENU.



**Note**

- This is available when a TV tuner box is installed.

**7** *Power indicator*

Shows PowerSaver mode by blinking green



**Note**

See PowerSaver described in the manual for further information regarding power saving functions. For energy conservation, turn your LCD Display OFF when it is not needed or when leaving it unattended for long periods.

**8** *Remote Control Sensor*

Aim the remote control towards this spot on the LCD Display.

---

## Rear



**Note**

For detailed information concerning cable connections, refer to Connecting Cables under Setup. The LCD Display 's configuration at the back may vary slightly depending on the LCD Display model.

---

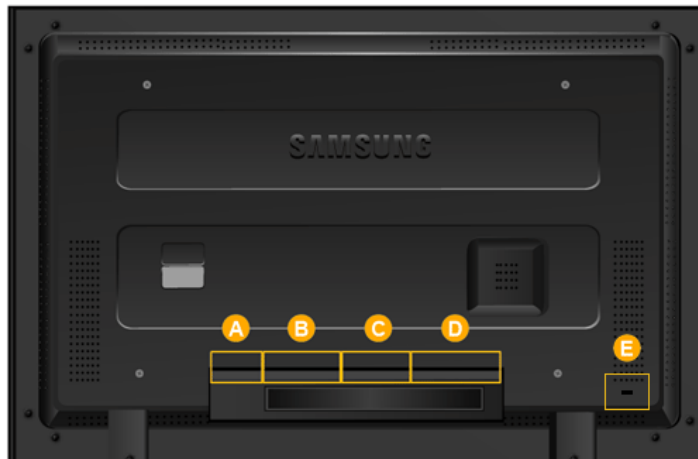

A



1 POWER S/W ON [ | ] / OFF [O]

Switches the LCD Display On/Off.

2 POWER IN

The power cord plugs into the LCD Display and the wall plug.

B

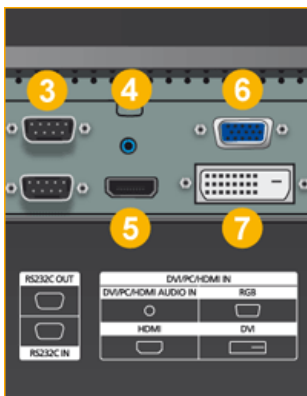

3 RS232C OUT/IN (RS232C Serial PORT)

MDC(Multiple Display Control) Program Port

4 DVI / PC / HDMI IN [DVI/PC/HDMI AUDIO IN] (PC/DVI/HDMI Audio Connection Terminal (Input))

5 DVI / PC / HDMI IN [HDMI]

Connect the HDMI terminal at the back of your LCD Display to the HDMI terminal of your digital output device using a HDMI cable.

6 DVI / PC / HDMI IN [RGB](PC Video Connection Terminal)

Using a D-Sub Cable (15 pin D-Sub) - PC mode (Analog PC)

7 DVI / PC / HDMI IN [DVI] (PC Video Connection Terminal)

Using a DVI Cable (DVI-D to DVI-D) - DVI mode (Digital PC)

C

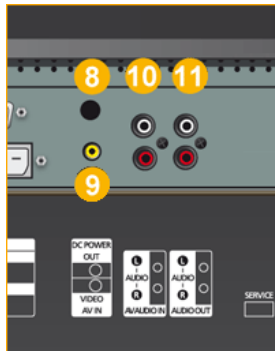

### 8 DC POWER OUT [Power]

Connect this to the **POWER** connector of a TV tuner box or network box.

### 9 AV IN [VIDEO] (VIDEO Connection Terminal)

Connect the [ VIDEO ] terminal of your monitor to the video output terminal of the external device using a VIDEO cable.

### 10 AV AUDIO IN [L-AUDIO-R](LCD Display Audio Connection Terminal (Input))

### 11 AV AUDIO OUT [L-AUDIO-R] (LCD Display Audio Connection Terminal (Output))

D

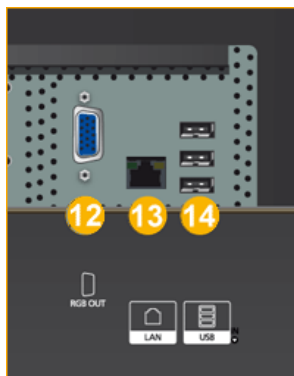

### 12 RGB OUT

(Applicable to the MXn model only)

### 13 LAN (LAN Connection Terminal)

(Applicable to the MXn model only)

### 14 USB(USB Connection Terminal)

Keyboard / Mouse, Mass Storage Device Compatible.

(Applicable to the MXn model only)

### Note

The number of LCD Displays that can be connected to loopout may differ depending on the cables, signal source etc. With cables where there is no degradation or signal source, up to ten LCD Displays can be connected.

E

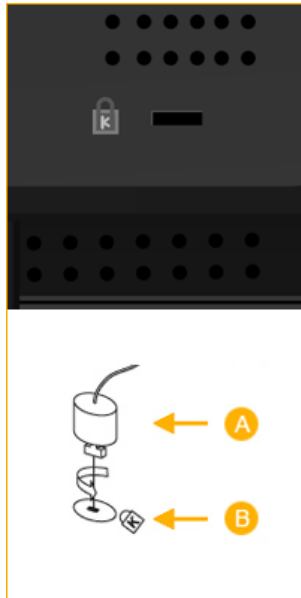

### *Kensington Lock*

The Kensington Lock is a device used to physically fix the system when using it in a public place. The locking device has to be purchased separately. The appearance and locking method may differ from the illustration depending on the manufacturer. Refer to the manual provided with the Kensington Lock for proper use. The locking device has to be purchased separately.



#### **Note**

The location of the Kensington Lock may be different depending on its model.

### **Using the Anti-Theft Kensington Lock**

1. Insert the locking device into the Kensington slot on the Monitor **B** and turn it in the locking direction **A**.
2. Connect the Kensington Lock cable.
3. Fix the Kensington Lock to a desk or a heavy stationary object.



#### **Note**

See Connecting Cables for further information regarding cable connections.

### **Remote Control**



#### **Note**

The performance of the remote control may be affected by a TV or other electronic device operating near the LCD Display, causing a malfunction due to interference with the frequency.

---

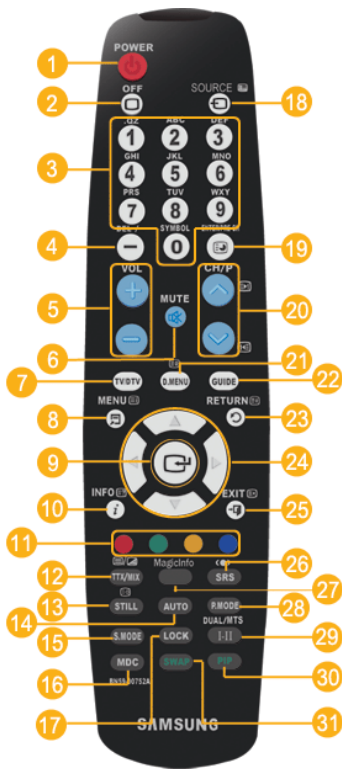

- 1. POWER
- 2. OFF
- 3. Number Buttons
- 4. DEL button
- 5. + VOL -
- 6. MUTE
- 7. TV/DTV
- 8. MENU
- 9. INFO
- 10. INFO
- 11. COLOR BUTTONS
- 12. TTX/MIX
- 13. STILL
- 14. AUTO
- 15. S.MODE
- 16. MDC
- 17. LOCK
- 18. SOURCE
- 19. ENTER/PRE-CH
- 20. CH/P
- 21. D.MENU
- 22. GUIDE
- 23. RETURN
- 24. Up-Down Left-Right buttons
- 25. EXIT
- 26. SRS
- 27. MagicInfo
- 28. P.MODE
- 29. DUAL/MTS
- 30. PIP
- 31. SWAP

1. POWER

Turns the product On.











2. Off



Turns the product Off.

3. Number Buttons

Press to change the channel.



4. DEL  button  
The "-" button operates only for DTV. It is used to select MMS (multi-channel) for a DTV.
5. + VOL -  
Adjusts the audio volume.
6.  MUTE  
Pauses (mutes) the audio output temporarily. This is displayed on the lower left corner of the screen. The audio resumes if MUTE or - VOL + is pressed in the Mute mode.
7. TV/DTV  
Selects the TV and DTV mode directly.
8.  MENU  
Opens the on-screen menu and exits from the menu or closes the adjustment menu.
9.   
Activates a highlighted menu item.
10.  INFO  
Current picture information is displayed on the upper left corner of the screen.
11. COLOR BUTTONS  
Press to add or delete channels and to store channels to the favorite channel list in the "Channel List" menu.
12.  TTX/MIX  
TV channels provide written information services via teletext.  
- Teletext Buttons  

- For more information > TTX / MIX
13. STILL  
Press the button once to freeze the screen. Press it again to unfreeze.
14. AUTO  
Adjusts the screen display automatically in **PC** mode. By changing the resolution in the control panel, auto function is performed.
15. S.MODE  
When pressing this button, the current mode is displayed at the bottom centre of the screen. The LCD Display has a built-in high fidelity stereo amplifier. Then press the button again to circle through available preconfigured modes. ( **Standard** → **Music** → **Movie** → **Speech** → **Custom** )
16. MDC  
MDC Quick Launch Button.
17. LOCK  
Activates or deactivates all function keys on both the remote control and the LCD Display except for the Power and LOCK buttons.
18.  SOURCE  
Press the button to change the input signal SOURCE.  
Changing the SOURCE is only allowed for external devices that are connected to the monitor at the time.
19.  ENTER/PRE-CH  
This button is used to return to the immediately previous channel.
20.  VCH/PA  
In **TV** mode, selects TV channels.
21. D.MENU  
DTV menu display
22. GUIDE  
Electronic Program Guide (EPG) display.
23.  RETURN  
Returns to the previous menu.

24. Up-Down Left-Right buttons  
 Moves from one menu item to another horizontally, vertically or adjusts selected menu values.
25. →  EXIT  
 Exits from the menu screen.
26.  SRS  
 Not Available.
27. MagicInfo  
 MagicInfo Quick Launch Button.
28. P.MODE  
 When you press this button, current picture mode is displayed on the lower center of the screen.

*AV / HDMI / TV : P.MODE*

The LCD Display has four automatic picture settings that are pre-set at the factory. Then push button again to circle through available preconfigured modes. ( **Dynamic** → **Standard** → **Movie** → **Custom** )

*PC / DVI / MagicInfo: M/B (MagicBright)*

**MagicBright** is a feature providing the optimum viewing environment depending on the contents of the image you are watching. Then push button again to circle through available preconfigured modes. ( **Entertain** → **Internet** → **Text** → **Custom** )

29.  DUAL/MTS

*DUAL-*

STEREO/MONO, DUAL I / DUAL II and MONO/NICAM MONO/NICAM STEREO can be operated depending on the broadcasting type by using the DUAL button on the remote control while watching TV.

*MTS-*

You can select MTS (Multichannel Television Stereo) mode.

	Audio Type	MTS/S_Mode	Default
FM Stereo	Mono	Mono	Manual Change
	Stereo	Mono ↔ Stereo	
	SAP	Mono ↔ SAP	

30. PIP  
 Every time you press the button, a PIP screen appears.

- This function does not work for this LCD Display.

31. SWAP  
 Swaps the contents of the PIP and main image. The image in the PIP window will appear on the main screen, and the main screen image will appear in the PIP window.

- This function does not work for this LCD Display.

---

---

# Connections

## Connecting a Computer



### Using a Power cord with Earth

- In the event of failure, the earth lead may cause electric shock. Make sure to wire the earth lead in correctly, before connecting the AC power. When un-wiring the earth lead, make sure to disconnect the AC power in advance.



### Note

AV input devices such as DVD players, VCR's or camcorders as well as your computer can be connected to the LCD Display. For detailed information on connecting AV input devices, refer to the User Controls under Adjusting Your LCD Display.

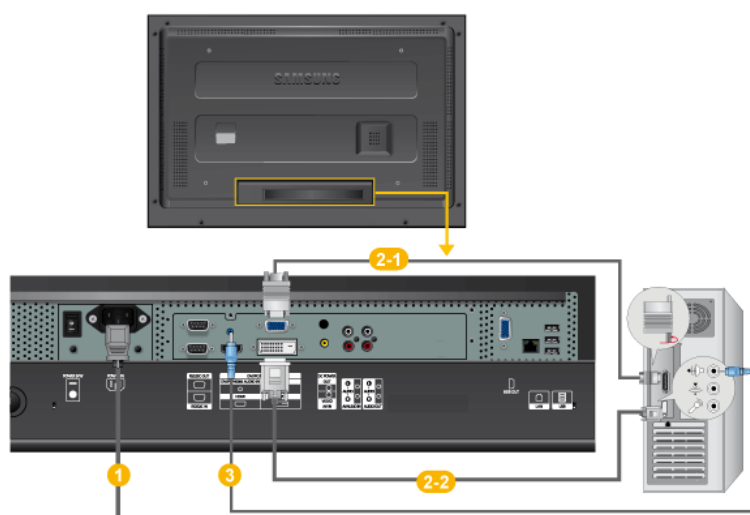

- 1 Connect the power cord for your LCD Display to the power port on the back of the LCD Display. Turn on the power switch.
- 2 There are 2 ways to connect the D-sub to your LCD Display. Choose one of the following:

2-1

Using the D-sub (Analog) connector on the video card.

- Connect the D-sub to the 15-pin, RGB port on the back of your LCD Display and the 15 pin D-sub Port on the computer.

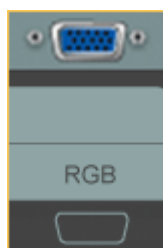

2-2

Using the DVI (Digital) connector on the video card.

- Connect the DVI Cable to the DVI port on the back of your LCD Display and the DVI port on the computer.
-



- 3 Connect the audio cable for your LCD Display to the audio port on the back of your computer.

 **Note**

- Turn on both your computer and the LCD Display.
- The DVI cable is optional.
- Contact a local SAMSUNG Electronics Service Center to buy optional items.

### Connecting to Other devices



#### Using a Power cord with Earth

- In the event of failure, the earth lead may cause electric shock. Make sure to wire the earth lead in correctly, before connecting the AC power. When unwiring the earth lead, make sure to disconnect the AC power in advance.

 **Note**

AV input devices such as DVD players, VCR's or camcorders as well as your computer can be connected to the LCD Display. For detailed information on connecting AV input devices, refer to the contents under Adjusting Your LCD Display.

### Connecting AV Devices

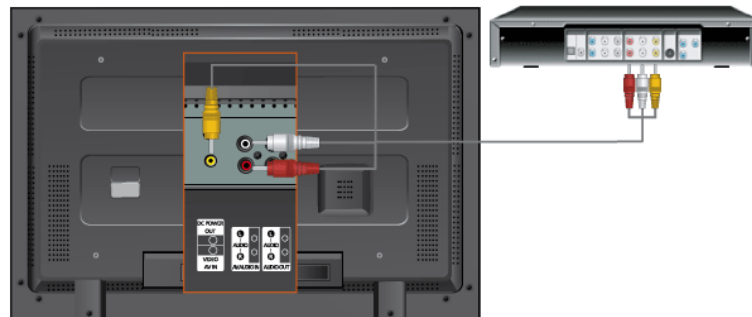

1. Connect the port of the DVD, VCR (DVD / DTV Set-Top Box) to the [R-AUDIO-L] port of the LCD Display.
2. Then, start the DVD, VCR or Camcorders with a DVD disc or tape inserted.
3. Select **AV** using the SOURCE .

 **Note**

The LCD Display has AV connection terminals to connect AV input devices like DVDs, VCRs or Camcorders. You may enjoy AV signals as long as the LCD Display is turned on.

## Connecting to a Camcorder

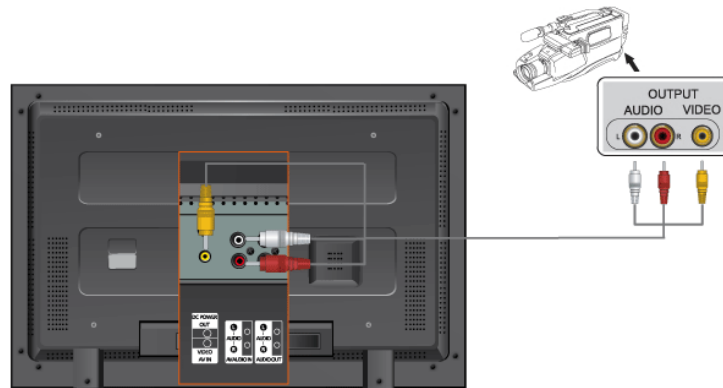

1. Locate the A/V output jacks on the camcorder. They are usually found on the side or back of the camcorder. Connect a set of audio cables between the AUDIO OUTPUT jacks on the camcorder and the AV AUDIO IN [L-AUDIO-R] on the LCD Display .
2. Connect a video cable between the VIDEO OUTPUT jack on the camcorder and the AV IN [VIDEO] on the LCD Display .
3. Select **AV** for the Camcorder connection using the Source button on the front of the LCD Display or on the remote control.
4. Then, start the Camcorders with a tape inserted.



### Note

The audio-video cables shown here are usually included with a Camcorder. (If not, check your local electronics store.) If your camcorder is stereo, you need to connect a set of two cables.

## Connecting Using a HDMI Cable

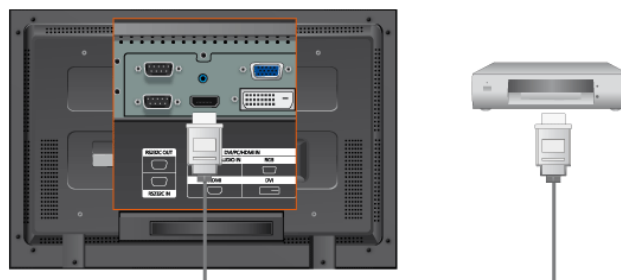

### Note

- Input devices such as digital DVD are connected to the HDMI terminal of the LCD Display using the HDMI cable.
- You cannot connect a PC to the HDMI terminal.

## Connecting Using a DVI to HDMI Cable

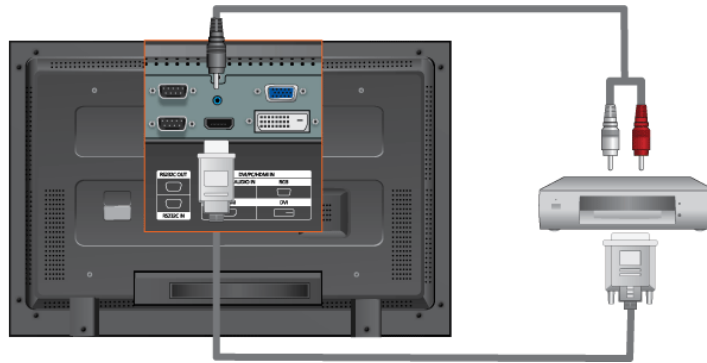

 **Note**

- Connect the DVI output terminal of a digital output device to the HDMI terminal of the LCD Display using a DVI to HDMI cable.
- Connect the red and white jacks of an RCA to stereo (for PC) cable to the same colored audio output terminals of the digital output device, and connect the opposite jack to the DVI / PC / HDMI AUDIO IN terminal of the LCD Display.

## Connecting to an Audio System

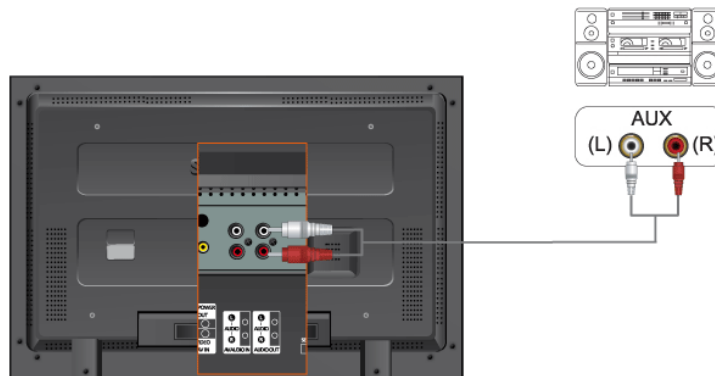

 **Note**

- Connect a set of audio cables between the AUX L, R jacks on the AUDIO SYSTEM and AUDIO OUT [L-AUDIO-R] on LCD Display.

## Connecting a LAN Cable



### Using a Power cord with Earth

- In the event of failure, the earth lead may cause electric shock. Make sure to wire the earth lead in correctly, before connecting the AC power. When unwiring the earth lead, make sure to disconnect the AC power in advance.

 **Note**

AV input devices such as DVD players, VCR's or camcorders as well as your computer can be connected to the LCD Display. For detailed information on connecting AV input devices, refer to the User Controls under Adjusting Your LCD Display.

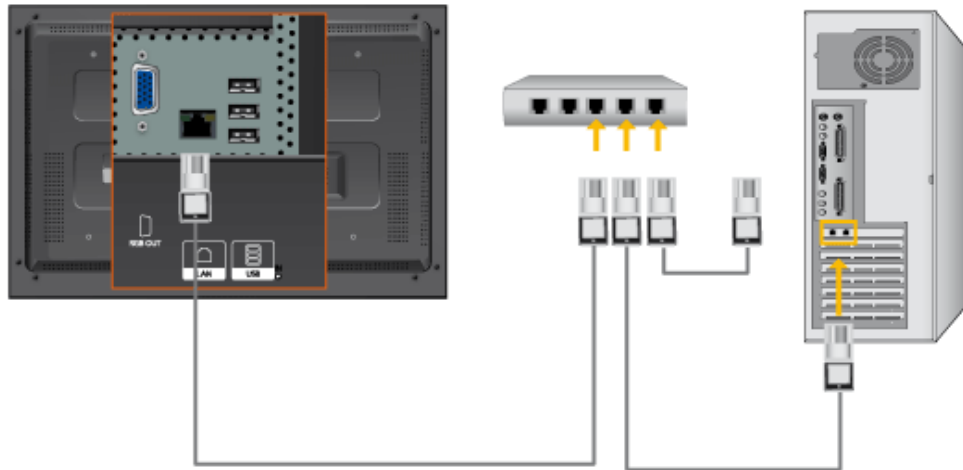

 **Note**

Connect the LAN cable.

(Applicable to the MXn model only)

### Connecting a USB device



#### Using a Power cord with Earth

- In the event of failure, the earth lead may cause electric shock. Make sure to wire the earth lead in correctly, before connecting the AC power. When unwiring the earth lead, make sure to disconnect the AC power in advance.

 **Note**

AV input devices such as DVD players, VCR's or camcorders as well as your computer can be connected to the LCD Display. For detailed information on connecting AV input devices, refer to the User Controls under Adjusting Your LCD Display.

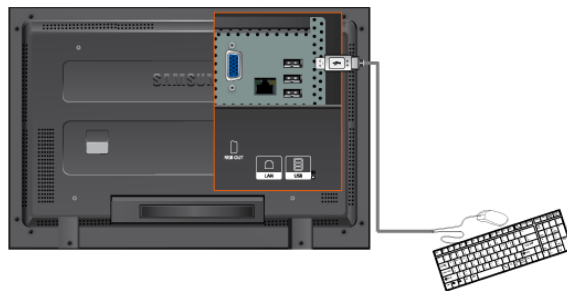

 **Note**

You can connect USB devices such as a mouse or keyboard.

(Applicable to the MXn model only)

---

# Troubleshooting

## Self-Test Feature Check



Check the following items yourself before calling for assistance. Contact a Service Center for problems that you cannot solve by yourself.

## Self-Test Feature Check

1. Turn off both your computer and the LCD Display.
2. Unplug the video cable from the back of the computer.
3. Turn on the LCD Display.

The figure shown below ("**Check Signal Cable**") appears on a black background when the LCD Display is working normally even though no video signal is detected: While in the Self-Test mode, the LED power indicator remains green and the figure moves around on the screen.



4. Turn off your LCD Display and reconnect the video cable; then turn on both your computer and the LCD Display

If your LCD Display screen remains blank after using the previous procedure, check your video controller and computer system; your LCD Display is functioning properly.

## Warning Messages

You can even view the screen at a resolution of 1360 x 768. However, you will receive the following message for a minute; You can choose to change the screen resolution or stay in the current mode during that time. And if the resolution is more than 85Hz, you will see the black screen because the LCD Display does not support over 85Hz.



Refer to Specifications > Preset Timing Modes for the resolutions or frequencies supported by the LCD Display.

## Maintenance and Cleaning

- 1) Maintaining the LCD Display Case.

Clean with a soft cloth after disconnecting the power cord.

---





- Do not use benzene, thinner or other flammable substances, or a wet cloth.
- We recommend that a SAMSUNG cleansing agent is used to prevent damage to the screen.

## 2) Maintaining the Flat Panel Display Screen.

Clean with a soft cloth (cotton flannel) smoothly.



- Never use acetone, benzene or thinner.  
(They may cause flaws or deformation of the screen surface.)
- The user will be required to pay costs and related expenses for repairing damages caused.

## Symptoms and Recommended Actions



### Note

A LCD Display recreates visual signals received from the computer. Therefore, if there is a problem with the computer or the video card, this can cause the LCD Display to become blank, have poor coloring, become noisy, and video mode not supported, etc. In this case, first check the source of the problem, and then contact a Service Center or your dealer.

1. Check if the power cord and the video cables are properly connected to the computer.
2. Check if the computer beeps more than 3 times when booting.  
(If it does, request an a service for the main board of the computer.)
3. If you installed a new video card or if you assembled the PC, check if you installed the Adaptor (video).
4. Check if the scanning ratio of the video screen is set to between 50 Hz ~ 85 Hz.  
(Do not exceed 60Hz when using the maximum resolution.)
5. If you have problems in installing the Adaptor (video) driver, boot the computer in Safe Mode, remove the Display Adaptor in the "Control Panel → System → Device Administrator" and then reboot the computer to reinstall the Adaptor (video) driver.

## Check List



### Note

- The following table lists possible problems and their solutions. Before calling for assistance, check the information in this section to see if you can remedy any problems for yourself. If you do need assistance, please call the phone number on the Information section or contact your dealer.
- For more network-related information, refer to the MagicInfo Troubleshooting section.

## Problems related to the Installation (PC Mode)



### Note

Problems related to the LCD Display installation and their solutions are listed.

Q: The LCD Display screen flickers.

---

A: Check if the signal cable between the computer and the LCD Display is securely connected.

(Refer to Connecting a Computer)

## Problems related to the Screen



### Note

Problems related to the LCD Display screen and their solutions are listed.

Q: The screen is blank and the power indicator is off.

A: Ensure that the power cord is firmly connected and the LCD Display is on.

(Refer to the Connecting a Computer)

Q: "**Check Signal Cable**" message.

A: Ensure that the signal cable is firmly connected to the PC or video sources.

(Refer to the Connecting a Computer)

A: Ensure that the PC or video sources are turned on.

Q: "**Not Optimum Mode**" message.

A: Check the maximum resolution and the frequency of the video Adaptor.

A: Compare these values with the data in the Preset Timing Modes Chart.

Q: The picture rolls vertically.

A: Check if the signal cable is securely connected. Re-connect it, if necessary.

(Refer to Connecting a Computer)

Q: The image is not clear; picture is blurred.

A: Run Frequency **Coarse** and **Fine** tuning.

A: Turn on again after removing all accessories (video extension cable, etc.)

A: Set the resolution and frequency to the recommended ranges.

Q: The picture image is unstable and shakes.

A: Check if the resolution and frequency set for the computer video card falls in the range supported by the LCD Display. If not, reset them referring to the current Information under the LCD Display menu and Preset Timing Modes.

Q: Ghost images are shown in the picture.

A: Check if the resolution and frequency set for the computer video card falls in the range supported by the LCD Display. If not, reset them referring to the current Information under the LCD Display menu and Preset Timing Modes.

Q: The image is too light or too dark.

A: Adjusts the **brightness** and **contrast**.

(Refer to the **Brightness, Contrast**)

Q: The screen color is inconsistent.

---

- A: Adjust color using **Custom** under OSD Color Adjustment menu.
- Q: The color image is distorted by dark shadows.
- A: Adjust color using **Custom** under OSD Color Adjustment menu.
- Q: The color white is poor.
- A: Adjust color using **Custom** under OSD Color Adjustment menu.
- Q: The Power Indicator blinks.
- A: The LCD Display is currently saving the changes made in the settings to the OSD memory.
- Q: The screen is blank and the power indicator light blinks every 0.5 or 1 seconds.
- A: The LCD Display is using its power management system.
- A: Press any key on the keyboard.
- Q: The screen is blank and it is blinking.
- A: If you see the "**TEST GOOD**" message on the screen when you pressing the MENU button, check the cable connection between the LCD Display and the computer to ensure that the connector is properly connected.

### Problems related to Audio



Problems related to audio signals and their solutions are listed below.

- Q: No sound.
- A: Ensure that the audio cable is firmly connected to both the audio-in port on your LCD Display and the audio-out port on your sound card.
- (Refer to the Connecting a Computer)
- A: Check the volume level.
- Q: The sound level is too low.
- A: Check the volume level.
- A: If the volume is still too low after turning the control to its maximum, check the volume control on the computer sound card or software program.
- Q: The sound is too high or too low.
- A: Adjusts the **Treble** and **Bass** to the appropriate levels.

### Problems related to the Remote Control



Problems related to the remote control and their solutions are listed.

- Q: The remote control buttons do not respond.
- A: Check the polarities (+/-) of the batteries.
- A: Check if the batteries are empty.
-

- A: Check if the power is on.
- A: Check if the power cord is securely connected.
- A: Check if a special fluorescent or neon lamp is on in the vicinity.

## Problems related to MagicInfo



Making a Bootable USB Flash Disk.

- Q: Making a Bootable USB Flash Disk
- A: 1) You can turn a common 512-MB or bigger USB storage media into a bootable disk using a USB bootable disk creation tool. (For example, the HP USB Disk Storage Format Tool)
- A: 2) Copies the OS ghost image and executables to your USB disk.
- A: 3) Enter the BIOS menu of your set by pressing the F2 key in the BIOS logo screen. Then, enable the USB Boot First option by selecting that option and pressing the Enter key in the Boot menu.
- A: 4) Switch your set on while your USB disk is connected and boot up in DOS mode.
- A: 5) Run C:\ghost.exe and choose Local → Partition → From Image from the menu. Choose the ghost image to update your USB disk with and choose the target disk.
- A: 6) When the ghost image update finishes, the set will be rebooted automatically.

## Q & A

- Q: How can I change the frequency?
- A: The frequency can be changed by reconfiguring the video card.



that video card support can vary, depending on the version of the driver used. (Refer to the computer or the video card manual for details.)

- Q: How can I Adjusts the resolution?
  - A: Windows XP:  
Set the resolution in the Control Panel → Appearance and Themes → Display → Settings.
  - A: Windows ME/2000:  
Set the resolution in the Control Panel → Display → Settings.  
\* Contact the video card manufacturer for details.
  - Q: How can I set the Power Saving function?
  - A: Windows XP:  
Set the resolution in the Control Panel → Appearance and Themes → Display → Screen Saver.  
Set the function in the BIOS-SETUP of the computer. (Refer to the Windows / Computer Manual).
  - A: Windows ME/2000:
-

Set the resolution at the Control Panel → Display → Screen Saver.

Set the function in the BIOS-SETUP of the computer. (Refer to the Windows / Computer Manual).

Q: How can I clean the outer case/LCD Panel?

A: Disconnect the power cord and then clean the LCD Display with a soft cloth, using either a cleaning solution or plain water.

Do not leave any detergent or scratches on the case. Do not let any water enter the LCD Display.

Q: How can I play the video?

A: The video supports the MPEG1 and WMV codecs only. Install the corresponding codec to play the video. Note that some of the codecs can be incompatible.



**Note**

Before calling for assistance, check the information in this section to see if you can remedy any problems yourself. If you do need assistance, please call the phone number on the Information section or contact your dealer.

---