



---

**OWNER'S OPERATING MANUAL**

---

**CRYSTAL**  
S E R I E S L

**CR-26HD**  
**CR-32HDi**

**High-Definition, Liquid-Crystal Display (LCD) Panels  
with Widevision™**



**THE WORLD'S FINEST HOME THEATER PRODUCTS™**



---

# ONE YEAR LIMITED WARRANTY

For LCD Displays

Congratulations on your purchase of a Runco video product and welcome to the Runco family! We believe Runco produces "The World's Finest Home Theater Products." With proper installation, setup and care, you should enjoy many years of unparalleled video performance.

This is a LIMITED WARRANTY as defined in the Magnuson-Moss Warranty Act. Please read it carefully and retain it with your other important documents.

## **WHAT IS COVERED UNDER THE TERMS OF THIS LIMITED WARRANTY:**

**SERVICE LABOR:** Runco will pay for service labor by a Runco Authorized Service Center when needed as a result of a manufacturing defect for a period of one (1) year from the effective date of delivery to the end user.

**PARTS:** Runco will provide new or rebuilt replacement parts for the parts that fail due to defects in materials or workmanship for a period of one (1) year from the effective date of delivery to the end user. Such replacement parts are then subsequently warranted for the remaining portion (if any) of the original warranty period.

## **WHAT IS NOT COVERED UNDER THE TERMS OF THIS LIMITED WARRANTY:**

Image retention on LCD display panels is specifically excluded from coverage under this Limited Warranty. Image retention or staining of an image is the result of misuse of the product and therefore cannot be repaired under the terms of this Limited Warranty.

Normal viewing material such as television/satellite broadcasts, videotape or DVDs (not put into pause for extended periods of time) will not cause damage to your display under normal conditions. Many DVD players are also equipped with screen savers for this reason.

**TO AVOID IMAGE RETENTION (Burn-in):** Please ensure that still images are not left on your LCD display panel. Also ensure that images displayed in the 4:3 aspect ratio mode (black or gray stripes, but no picture information is present on the left and right edges of the screen) are used as infrequently as possible. This will prevent permanent retention on your LCD display panel, which can be seen permanently under certain conditions once burn-in has occurred.

The types of images to avoid include video games, still images and computer screens with stationary tool bars and icons. (This is why computers are equipped with screen savers – to prevent still images from burning into the monitor's phosphors after being displayed continuously for an extended period of time).

This Limited Warranty only covers failure due to defects in materials and workmanship that occur during normal use and does not cover normal maintenance. This Limited Warranty does not cover cabinets or any appearance items; failure resulting from accident, misuse, abuse, neglect, mishandling, misapplication, faulty or improper installation or setup adjustments; improper maintenance, alteration, improper use of any input signal; damage due to lightning or power line surges, spikes and brownouts; damage that occurs during shipping or transit; or damage that is attributed to acts of God. In the case of remote control units, damage resulting from leaking, old, damaged or improper batteries is also excluded from coverage under this Limited Warranty.

**CAUTION:** THIS LIMITED WARRANTY ONLY COVERS RUNCO PRODUCTS PURCHASED FROM RUNCO AUTHORIZED DEALERS. ALL OTHER PRODUCTS ARE SPECIFICALLY EXCLUDED FROM COVERAGE UNDER THIS LIMITED WARRANTY. MOREOVER, DAMAGE RESULTING DIRECTLY OR INDIRECTLY FROM IMPROPER INSTALLATION OR SETUP IS SPECIFICALLY EXCLUDED FROM COVERAGE UNDER THIS LIMITED WARRANTY. IT IS IMPERATIVE THAT INSTALLATION AND SETUP WORK BE PERFORMED ONLY BY AN AUTHORIZED RUNCO DEALER TO PROTECT YOUR RIGHTS UNDER THIS WARRANTY. THIS WILL ALSO ENSURE THAT YOU ENJOY THE FINE PERFORMANCE OF WHICH YOUR RUNCO PRODUCT IS CAPABLE WHEN INSTALLED AND CALIBRATED BY RUNCO AUTHORIZED PERSONNEL.

---

## **RIGHTS, LIMITS AND EXCLUSIONS:**

Runco limits its obligations under any implied warranties under state laws to a period not to exceed the warranty period. There are no express warranties. Runco also excludes any obligation on its part for incidental or consequential damages related to the failure of this product to function properly. Some states do not allow limitations on how long an implied warranty lasts, and some states do not allow the exclusion or limitation of incidental or consequential damages. So the above limitations or exclusions may not apply to you. This warranty gives you specific legal rights, and you may also have other rights that vary from state to state.

## **EFFECTIVE WARRANTY DATE:**

This warranty begins on the effective date of delivery to the end user. For your convenience, keep the original bill of sale as evidence of the purchase date.

## **IMPORTANT – WARRANTY REGISTRATION:**

Please fill out and mail your warranty registration card. It is imperative that Runco knows how to reach you promptly if we should discover a safety problem or product update for which you must be notified.

## **CONTACT A RUNCO AUTHORIZED SERVICE CENTER TO OBTAIN SERVICE:**

Repairs made under the terms of this Limited Warranty covering your Runco video product will be performed at the location of the product, during usual working hours, providing location of product is within normal operating distance from a Runco Authorized Service Center. In some instances it may be necessary for the product to be returned to the Runco factory for repairs. If, solely in Runco's judgment, location of product to be repaired is beyond normal operating distance of the closest Runco Authorized Service Center, or the repair requires the unit be returned to the Runco factory, it is the owner's responsibility to arrange for shipment of the product for repair. These arrangements must be made through the selling Runco Dealer. If this is not possible, contact Runco directly for a Return Authorization number and shipping instructions. Runco will return product transportation prepaid in the United States, unless no product defect is discovered. In that instance, shipping costs will be the responsibility of the owner.

## **COPYRIGHT AND TRADEMARKS:**

© Copyright 2007 Runco International. This document contains proprietary information protected by copyright, trademark and other intellectual property laws. All rights are reserved. No part of this manual may be reproduced by any mechanical, electronic or other means, in any form, without prior written permission of the manufacturer.

Reflection, Enhanced GEN3, DHD, Vivix, Virtual Cinema, CineWide, AutoScope, O-Path, CinOptx, LiveLink, CSMS, SuperOnyx and VirtualWide are trademarks of Runco International. All other trademarks and registered trademarks used in this document are the property of their respective owners.

Runco International products are manufactured under one or more of the following patents: US. Patent 6755540 and Other Patents Pending.

---

**ADDITIONAL INFORMATION:**

To locate the name and address of the nearest Runco Authorized Service Center, or for additional information about this Limited Warranty, please call or write:

**RUNCO INTERNATIONAL, INC.**  
**Attn: Customer Service Department**  
**2900 Faber Street**  
**Union City, CA 94587**  
**Ph: (510) 324-7777**  
**Fax: (510) 324-9300**  
**Toll Free: (800) 23-RUNCO**

---

**RUNCO VIDEO-PRODUCT INFORMATION**  
**RETAIN THIS INFORMATION FOR YOUR RECORDS**

---

Model Purchased

---

Date

---

Serial Number

---

Runco Authorized Dealer Name

---

Address

---

City

---

State/Province

---

Postal Code

---

Phone

---

Fax

# Important Safety Instructions

Thank you for your purchase of this quality Runco product! For best performance, please read this manual carefully as it is your guide through the menus and operation.

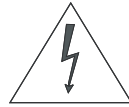
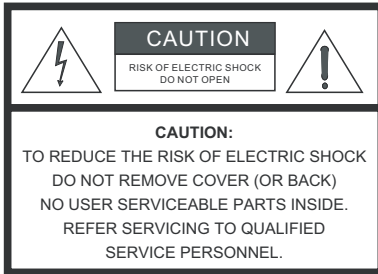

## WARNING

This symbol is intended to alert the user to the presence of uninsulated “dangerous voltage” within the product’s enclosure that may be of sufficient magnitude to constitute a risk of electric shock.



This symbol is intended to alert the user to the presence of important operating and maintenance (servicing) instructions in the literature accompanying the appliance.

1. Read these instructions.
2. Keep these instructions.
3. Heed all warnings.
4. Follow all instructions.
5. Do not use this apparatus near water.
6. Clean only with a dry cloth.
7. Do not block any of the ventilation openings. Install in accordance with the manufacturer’s instructions.
8. Do not install near any heat sources such as radiators, heat registers, stoves, or other apparatus (including amplifiers) that produce heat.
9. Do not defeat the safety purpose of the polarized or grounding type plug. A polarized plug has two blades with one wider than the other. A grounding type plug has two blades and a third grounding prong. The wide blade or the third prong is provided for your safety. When the provided plug does not fit into your outlet, consult an electrician for the replacement of the obsolete outlet.
10. Protect the power cord from being walked on or pinched particularly at plugs, convenience receptacles and the point where they exit from the apparatus.
11. Only use the attachments/accessories specified by Runco.
12. Use only with a cart, stand, tripod, bracket or table specified by the manufacturer or sold with the apparatus. When a cart is used, use caution when moving the cart/apparatus to avoid injury from tip-over.
13. Unplug this apparatus during lightning storms or when unused for long periods of time.
14. Refer all servicing to qualified service personnel. Servicing is required when the apparatus has been damaged in any way, such as power supply cord or plug is damaged, liquid has been spilled or objects have fallen into the apparatus, the apparatus has been exposed to rain or moisture, does not operate normally, or has been dropped.



# Compliance Information

## DECLARATION OF CONFORMITY:

Manufacturer's Name: Runco International, a subsidiary of Planar Systems, Inc.

Manufacturer's Address: 2900 Faber Street, Union City, CA 94587

hereby declares that the products Model Numbers:

CR-26HD, CR-32HDI

conform with the provisions of:

Council Directive 2004/108/EC on Electromagnetic Compatibility;

EN 55022 "Limits and methods of measurements of radio interference characteristics of information technology equipment" 1998;

EN 55024 "Limits and methods of measurements of immunity characteristics of information technology equipment" 1998;

Including:

- EN 61000-4-2 "Electromagnetic compatibility (EMC) Part 4: Testing and measurement techniques Section 2: Electrostatic discharge immunity test"
- EN 61000-4-3 "Electromagnetic compatibility (EMC) Part 4: Testing and measurement techniques Section 3: Radiated, Radio-Frequency, Electromagnetic Field Immunity Test"
- EN 61000-4-4 "Electromagnetic compatibility (EMC) Part 4: Testing and measurement techniques Section 4: Electrical fast transient/burst immunity test"
- EN 61000-4-5 "Electromagnetic compatibility (EMC) Part 4: Testing and measurement techniques Section 5: Surge immunity test"
- EN 61000-4-6 "Electromagnetic compatibility (EMC) Part 4: Testing and measurement techniques Section 6: Conducted disturbances induced by radio-frequency fields immunity test"
- EN 61000-4-8 "Electromagnetic compatibility (EMC) Part 4: Testing and measurement techniques Section 8: Conducted disturbances induced by power frequency magnetic fields immunity test"
- EN 61000-4-11 "Electromagnetic compatibility (EMC) Part 4: Testing and measurement techniques Section 11: Voltage dips, short interruptions and voltage variations immunity tests"

And:

- EN 61000-3-2 "Electromagnetic compatibility (EMC) Part 3, Section 2: Limits for harmonic current emissions (equipment input current up to and including 16 A per phase)" 2000;
- EN 61000-3-3 "Electromagnetic compatibility (EMC) Part 3, Section 3: Limitations of voltage changes, voltage fluctuations and flicker in public low-voltage supply systems, for equipment with rated current up to and including 16 A and not subject to conditional connection" 1995;

Council Directive 2006/95/EC and amended by M1 and C1 on Low Voltage Equipment Safety;

EN 60950 "Safety of information technology equipment, including electrical business equipment"

The Technical Construction file required by this Directive is maintained at the corporate headquarters of Planar Systems, Inc., 1195 NW Compton Drive, Beaverton, OR 97006.

Date of Declaration: October 2007

## FCC PART 15:

NOTE: This equipment has been tested and found to comply with the limits for a Class B digital device, pursuant to Part 15 of the FCC Rules. These limits are designed to provide reasonable protection against harmful interference in a residential installation.

This equipment generates, uses and can radiate radio frequency energy and, if not installed and used in accordance with the instructions, may cause harmful interference to radio communications. However, there is no guarantee that interference will not occur in a particular installation. If this equipment does cause harmful interference to radio or television reception, which can be determined by turning the equipment off and on, the user is encouraged to try to correct the interference by one or more of the following measures:

- Reorient or relocate the receiving antenna.
- Increase the separation between the equipment and receiver.
- Connect the equipment into an outlet on a circuit different from that to which the receiver is connected.
- Consult the dealer or an experienced radio/TV technician for help.

## INDUSTRY CANADA (ICES-003):

This Class B digital apparatus complies with Canadian ICES-003.

Cet appareil numérique de la classe B est conforme à la norme NMB-003 du Canada.

## IMPORTANT RECYCLE INSTRUCTIONS



Lamp(s) inside this product contain mercury. This product may contain other electronic waste that can be hazardous if not disposed of properly. Recycle or dispose in accordance with local, state, or federal Laws.

For more information, contact the Electronic Industries Alliance at [WWW.EIAE.ORG](http://WWW.EIAE.ORG).

For lamp specific disposal information check [WWW.LAMPRECYCLE.ORG](http://WWW.LAMPRECYCLE.ORG).

## DISPOSAL OF OLD ELECTRICAL AND ELECTRONIC EQUIPMENT (Applicable throughout the European Union and other European countries with separate collection programs)



This symbol found on your product or on its packaging, indicates that this product should not be treated as household waste when you wish to dispose of it. Instead, it should be handed over to an applicable collection point for the recycling of electrical and electronic equipment. By ensuring this product is disposed of correctly, you will help prevent potential negative consequences to the environment and human health, which could otherwise be caused by inappropriate disposal of this product. The recycling of materials will help to conserve natural resources. This symbol is only valid in the European Union. If you wish to discard this product, please contact your local authorities or dealer and ask for the correct method of disposal.



# Table of Contents

<b>ONE YEAR LIMITED WARRANTY .....</b>	<b>iii</b>
<b>Important Safety Instructions .....</b>	<b>vi</b>
<b>Compliance Information .....</b>	<b>vii</b>
<b>1. Introduction .....</b>	<b>1</b>
About This Manual .....	1
Target Audience .....	1
If You Have Comments About This Manual.....	1
Textual and Graphic Conventions .....	1
Using This Manual .....	2
Description, Features and Benefits .....	3
Key Features and Benefits .....	3
Parts List .....	4
<b>2. Controls and Functions .....</b>	<b>5</b>
Crystal Series LCD Display at a Glance .....	5
Controls and Indicators.....	5
Crystal Series LCD Display Inputs and Outputs.....	6
Crystal Series LCD Display Remote Control .....	8
<b>3. Installation .....</b>	<b>13</b>
Remote Control .....	13
Battery Installation .....	13
Notes on Remote Control Operation.....	13
Quick Setup .....	14
Installation Considerations .....	15
Wall-Mounting the Crystal Series LCD Display .....	15
Ambient Light .....	15
Other Considerations.....	15
Connections to the Crystal Series LCD Display .....	16
Rear Connector Access.....	16
Connecting the Crystal Series LCD Display to Source Components.....	16
MONITOR OUT Connection.....	20
Connecting Headphones .....	20
RS-232 Controller Connection.....	21

---

<b>4. Operation .....</b>	<b>23</b>
Turning on the Power .....	23
Changing the OSD Language .....	23
Setting the PC Display Properties .....	24
Using the On-Screen Menus .....	25
Main Menu .....	27
Source .....	27
Aspect Ratio .....	27
Picture Adjust .....	29
Audio .....	33
Channel .....	34
Timer .....	34
Setup.....	35
ISF Calibration .....	38
Using Picture-In-Picture (PIP) .....	41
Changing the PIP Position .....	42
Changing the PIP Size .....	43
Changing the PIP Aspect Ratio .....	43
Changing the PIP Image Mode .....	43
Swapping the Main and PIP Images .....	44
Swapping the Main and PIP Audio Programs.....	44
Stereo Sound/SAP .....	45
<b>5. Maintenance and Troubleshooting .....</b>	<b>47</b>
Cleaning .....	47
Cleaning the Display Panel Body and Remote Control .....	47
Cleaning the Screen.....	47
Cleaning the Vents.....	47
Troubleshooting Tips .....	47
<b>6. Serial Communications .....</b>	<b>49</b>
RS-232 Connection and Port Configuration .....	49
Serial Command Syntax .....	49
<b>7. Specifications .....</b>	<b>53</b>
Crystal Series LCD Display Specifications .....	53
Crystal Series LCD Display Dimensions .....	54
Computer/Video Signal Compatibility .....	56

# List of Figures

---

2-1. Crystal Series LCD Display Controls and Indicators .....	5
2-2. Crystal Series LCD Display Rear-Panel Inputs and Outputs .....	6
2-3. Crystal Series LCD Display Remote Control.....	8
3-1. Antenna/Cable TV Connection .....	16
3-2. DVI Connections .....	17
3-3. Analog RGB Connections.....	18
3-4. Component Video Connections.....	19
3-5. Composite and S-Video Connections.....	19
3-6. Monitor Output Connections .....	20
3-7. Connecting Headphones.....	20
3-8. RS-232 Control System Connection.....	21
4-1. Crystal Series LCD Display OSD Menu Structure.....	26
4-2. Typical PLUGE Pattern for Adjusting Brightness .....	29
4-3. Typical Gray Bar Pattern for Adjusting Contrast .....	30
4-4. Typical Color Bar Pattern for Adjusting Color Saturation and Tint.....	31
4-5. Typical Test Pattern for Adjusting Sharpness .....	32
4-6. Crystal Series LCD Display Splash Screen.....	40
7-1. CR-26HD Dimensions .....	54
7-2. CR-32HDi Dimensions .....	55

**Notes:**

# 1. Introduction

---

This Owner's Manual describes how to install, set up and operate the Runco CR-26HD and CR-32HDi LCD Displays. Throughout this manual, the Runco CR-26HD and CR-32HDi LCD Displays are referred to simply as the "Crystal Series LCD Display."

Runco has prepared this manual to help home theater installers and end users get the most out of the Crystal Series LCD Display.

Runco has made every effort to ensure that this manual is accurate as of the date it was printed. However, because of ongoing product improvements and customer feedback, it may require updating from time to time. You can always find the latest version of this and other Runco product manuals on-line, at [www.runco.com](http://www.runco.com).

Runco welcomes your comments about this manual. Send them to [techpub@runco.com](mailto:techpub@runco.com).

**Text Conventions:** The following conventions are used in this manual, in order to clarify the information and instructions provided:

- Remote control button identifiers are set in upper-case bold type; for example, "Press **EXIT** to return to the previous menu."
- Computer input (commands you type) and output (responses that appear on-screen) is shown in monospace (fixed-width) type; for example: "To change the aspect ratio to Letterbox, type [S4E0002."
- All keys with functional names are initial-capped, set in bold type and enclosed in angle brackets. These keys are the following: **<Enter>**, **<Spacebar>**, **<Control>**, **<Esc>** and **<Tab>**.
- **<Enter>** indicates that you may press either the RETURN or ENTER key on your computer keyboard if it has both keys.

In addition to these conventions, underlining, boldface and/or italics are occasionally used to highlight important information, as in this example:



*A carriage return **must** be used after each command or string.*

---

## 1.1 About This Manual

### ◀ Target Audience

### ◀ If You Have Comments About This Manual...

### ◀ Textual and Graphic Conventions

**Graphic Conventions:** These symbols appear in numerous places throughout the manual, to emphasize points that you must keep in mind to avoid problems with your equipment or injury:



**Tip**

*TIPS highlight time-saving short cuts and helpful guidelines for using certain features.*



**Note**

*NOTES emphasize text with unusual importance or special significance. They also provide supplemental information.*



**Caution**

*CAUTIONS alert users that a given action or omitted action can degrade performance or cause a malfunction.*



**WARNING**

*WARNINGS appear when a given action or omitted action can result in damage to the equipment, or possible non-fatal injury to the user.*



**DANGER!**

*DANGER appears when a given action can cause severe injury or death.*

## 1.2 Using This Manual

Use the following table to locate the specific information you need in this manual.

If you need...	... Turn to page:
Information about obtaining service	iv
General information about the CR-26HD and CR-32HDi LCD Displays	3
Installation instructions	13
First-time configuration instructions	23
Advanced configuration instructions	38
Troubleshooting tips	47
Specifications for the CR-26HD and CR-32HDi LCD Displays	53

Runco presents the high performance CR-26HD and CR-32HDI LCD Displays, perfect for those who demand our award-winning flat panel performance in a more intimate size than we offer with our larger plasma monitors. The Crystal Series LCD Displays are ideal for close-in viewing where picture quality remains a high priority, but larger displays cannot be accommodated.

The Crystal Series LCD Display CR-26HD and CR-32HDI LCD Displays incorporate the superb Vivix™ digital video processing that produces outstanding picture quality with a wide range of both standard and high definition source material. In addition, the handsome, gloss black-finish television is engineered with ISF™ calibration standards for the purest video performance.

The CR-26HD and CR-32HDI LCD Displays also feature a built-in ATSC tuner that receives terrestrial DTV broadcasts, in addition to an advanced, 185 channel, cable-ready NTSC stereo tuner. The Crystal Series LCD Display offers PIP, PBP, closed captioning, Parental Control (V-Chip) functionality and multi-language support. The display includes an integrated stereo audio system incorporating surround sound technology with two-way speakers and generous power amplification.

The advanced TFT active-matrix LCD display panel offers 1366 x 768 resolution and includes Runco's discrete aspect ratio control with VirtualWide™ mode to fill the 16:9 screen with standard 4:3 images without loss of picture quality. Also included are discrete source, aspect ratio and power selection and an RS-232 interface for whole house or automated control system integration.

The Crystal Series LCD Display is multimedia ready, with simple computer connections making gaming, Internet browsing and other computer activities quick and easy.

The Crystal Series LCD Display offers these key features and benefits:

- Native Resolution: 1366 x 768 (16:9 Native Aspect Ratio)
- Multiple Aspect Ratios with VirtualWide™ Mode
- Less than 4 inches thin
- DVI Input with High-bandwidth Digital Content Protection (HDCP)
- Built-in HDTV Tuner
- Exceptional detail and artifact-free video enhancement
- Runco video processing with 3:2 film detection circuitry

---

### **1.3 Description, Features and Benefits**

#### **◀ Key Features and Benefits**

**Parts List** ➤ Your Crystal Series LCD Display is shipped with the following items. If any items are missing or damaged, please contact your Runco dealer or Runco Customer Service at (800) 23-RUNCO.

- CR-26HD or CR-32HDi LCD Display (with Table Stand)
- Remote Control Unit and two (2), AAA-size batteries
- AC Power Cord
- Warranty information and registration card
- Runco CR-26HD/CR-32HDi Owner's Operating Manual (this document)

**Optional Accessories:**

- Wall Mount kit



# Controls and Functions

## 2.1 Crystal Series LCD Display at a Glance

Figure 2-1 shows the locations of the Crystal Series LCD Display controls and indicators.

◀ **Controls and Indicators**

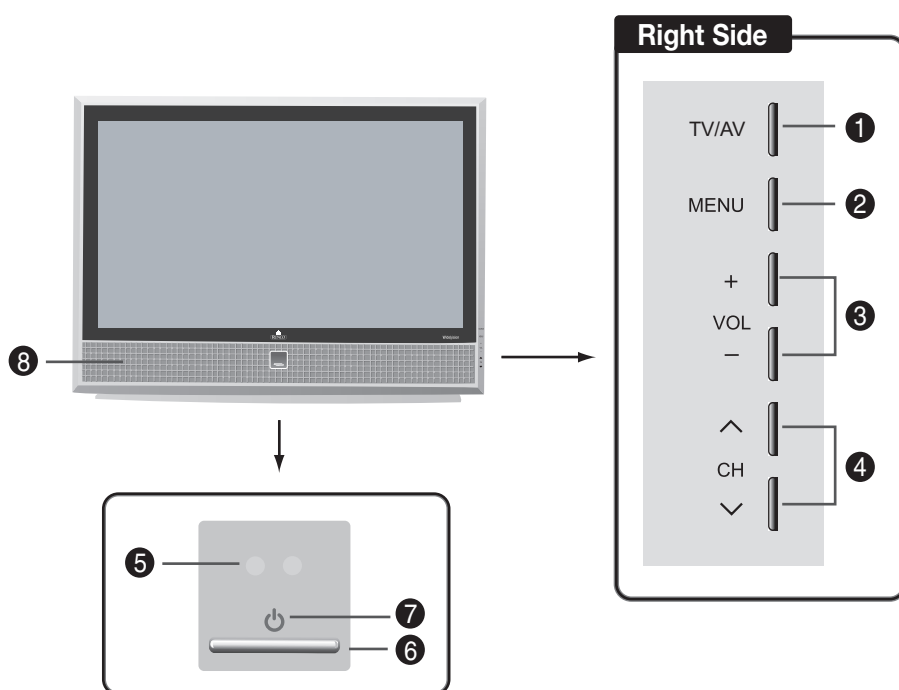

**Figure 2-1. Crystal Series LCD Display Controls and Indicators**

1. **TV/AV Button (Input Source Selection)**

2. **MENU Selection Button**

3. **Volume Adjustment Buttons**

4. **Channel Selection Buttons**

5. **Remote Control Sensor**

6. **Power Button**

7. **Power Indicator**

Lights red to indicate that the Crystal Series LCD Display is in standby mode; lights green to indicate normal operation; flashes green when the Crystal Series LCD Display receives a signal from the remote control.

8. **Speakers**

**Crystal Series LCD Display** ➤  
**Inputs and Outputs**

Figure 2-2 shows the locations of the Crystal Series LCD Display inputs and outputs.

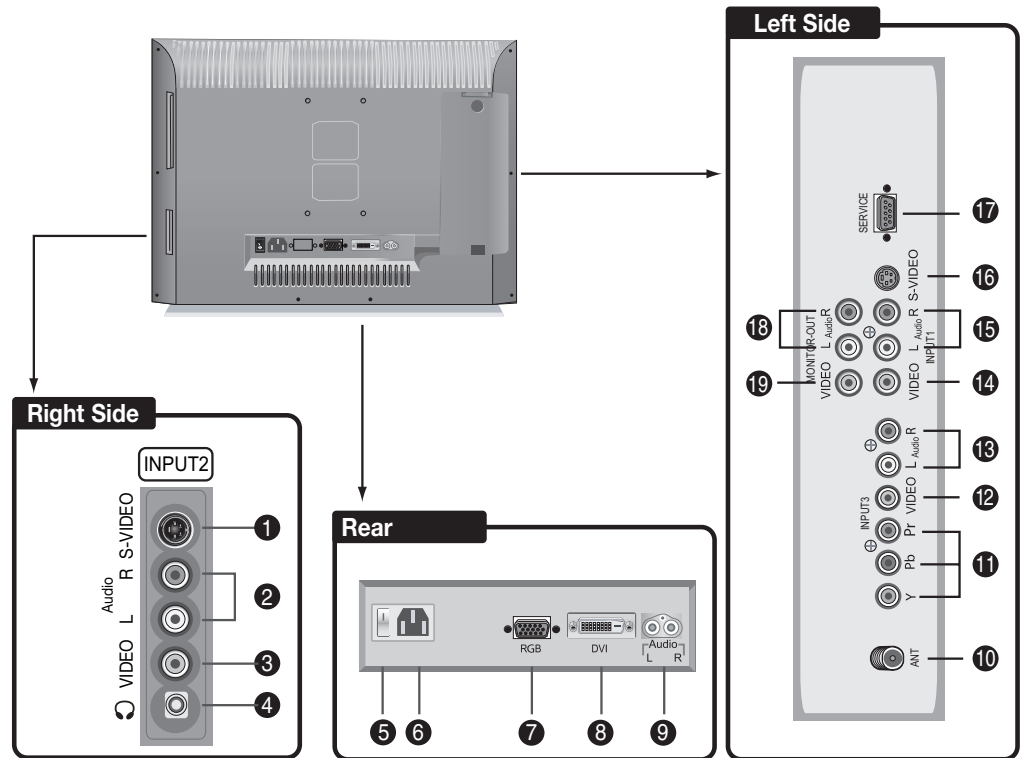

**Figure 2-2. Crystal Series LCD Display Rear-Panel Inputs and Outputs**

1. **INPUT 2 S-Video Input**  
Standard S-Video input for connecting a DVD player, satellite receiver or Super VHS (S-VHS) VCR.
2. **INPUT 2 Audio Input**
3. **INPUT 2 Composite Video Input**  
Standard composite video input for connecting a VCR, camcorder, laser disc player or other composite video source.
4. **Headphone Jack**
5. **Main Power Switch (CR-32HDi only)**
6. **Power Input (100 to 240 VAC)**  
Connect the Crystal Series LCD Display to power here.
7. **RGB HD**  
A 15-pin VGA connection to a personal computer. The Crystal Series LCD Display automatically detects the signal resolution.

---

**8. DVI/Computer Input (Digital)**

HDCP-compliant digital video input for connecting a DVD player, personal computer or HD tuner with a DVI or HDMI output.



*For best results, do not run your DVD player in progressive mode.*

**9. Audio Input (RGB/DVI)**

Connect the audio output from your RGB or DVI source here.

**10. ATSC DTV Input**

75-ohm coaxial input for connecting a TV antenna or CATV system to the digital TV tuner.

**11. INPUT 3 Component Video (RCA connectors)**

Standard-definition (480i/576i) or high-definition (720p/1080i), YPrPb component input. This is the input for component video from sources such as DVD players.

**12. INPUT 3 Composite Video Input****13. INPUT 3 Audio Input**

Connect the audio output from your Input 3 source here.

**14. INPUT 1 COMPOSITE VIDEO INPUT****15. INPUT 1 Audio Input**

Connect the audio output from your Input 1 source here.

**16. INPUT1 S-Video Input****17. RS-232 CONTROL PORT**

A male, 9-pin D-sub connector for interfacing with a PC or home theater automation/control system.

**18. MONITOR-OUT (Audio)****19. MONITOR-OUT (Composite Video)**

## 2.2 Crystal Series LCD Display Remote Control

Figure 2-3 shows the Crystal Series LCD Display remote control, and the paragraphs that follow describe its functionality.

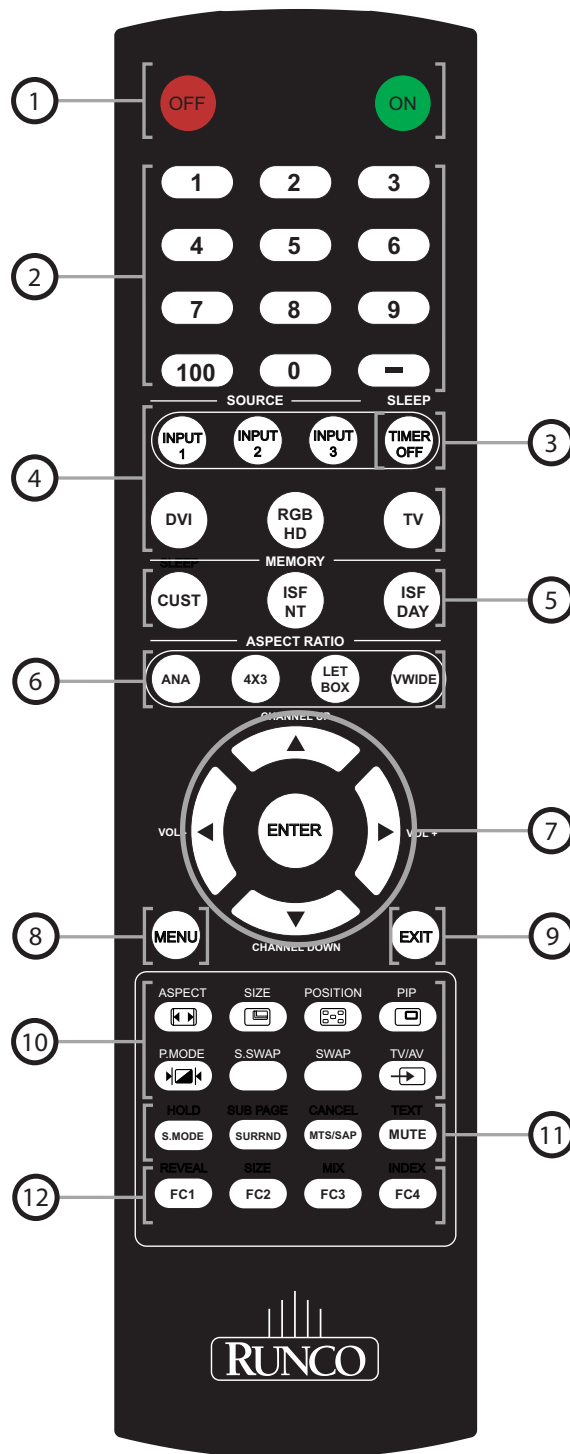

Figure 2-3. Crystal Series LCD Display Remote Control

---

**1. OFF / ON**

Use these buttons to turn the Crystal Series LCD Display on or off.

**2. Numeric Buttons**

Use these buttons to enter TV channel numbers or menu pass codes. Use the **100** button to enter channel numbers above 99. Use the **-** button to enter DTV sub-channel numbers.

**3. TIMER OFF Button**

Press this button to set the sleep timer. Press it repeatedly to scroll through the available options (Off, 10, 30, 60, 120 or 180 minutes).

**4. Source Selection Buttons:****INPUT 1**

Press this button to switch to Input 1.

**INPUT 2**

Press this button to switch to Input 2.

**INPUT 3**

Press this button to switch to Input 3.

**DVI**

Press this button to switch to the Digital Video input.

**RGB HD**

Press this button to switch to the RGB HD input.

**TV**

Press this button to switch to the Antenna/DTV/CATV input.

**Note**

*Input 1 and Input 2 have both S-Video and composite video connectors. Input 3 has both component and composite video connectors.*

*To specify which connection type you are using – or to switch from one to the other if equipment is connected to both – use the Input Selection menu under Setup (refer to **Input Selection** on page 37).*

**5. Memory Preset Buttons:****CUST**

Press to recall settings for the current input from the “Custom” memory preset.

**ISF NT (Night)**

Press to recall settings for the current input from the “ISF Night” memory preset.

**ISF DAY**

Press to recall settings for the current input from the “ISF Day” memory preset.

6. **Aspect Ratio Selection Buttons:**

**ANA (Anamorphic)**

For 16:9 DVDs or HDTV program material.

**4X3 (Standard 4:3)**

The input signal is scaled to fit 4:3 display mode in the center of the screen.

**LETBOX (Letterbox)**

Image in letterbox format is enlarged to fit 16:9 full screen display and the upper/lower portions are "blanked off."

**VWIDE (VirtualWide)**

4:3 image is enlarged NON-linearly in horizontal direction to fit 16:9 full screen display.

7. **Arrow Buttons (▲, ◀, ▼, ▶)**

Use these buttons to select items or settings, adjust settings, change TV channels or adjust sound volume.

**ENTER**

Press to select a highlighted menu item or confirm a changed setting.

8. **MENU**

Press this button to access the on-screen display (OSD) controls, or to exit the current menu and return to the previous one.

9. **EXIT**

Press this button to hide the OSD controls, or display program information (when available) if the OSD controls are already hidden.

10. **Picture-In-Picture (PIP) Function Buttons**

**ASPECT** 

Press to change the aspect ratio of the PIP window from 4:3 to 16:9 or vice versa.

**SIZE** 

Press to choose from three PIP window sizes.

**POSITION** 

Press to choose the PIP window position (top left, top right, bottom left or bottom right corner).

**PIP** 

Press to change the PIP mode (picture-in-picture, picture-by-picture or off).

**P.MODE** 

Press to recall settings for the PIP input from either the "ISF Night" or "ISF Day" memory preset.

**S.SWAP**

Press to switch between the main and PIP audio programs.

**SWAP**

Press to swap the main and PIP windows.

**TV/AV** 

Press to switch to a different PIP video source.

## 11. Sound Control Buttons:

### **S.MODE**

Press this button repeatedly to scroll through the available Equalizer presets (CUSTOM, STANDARD, MUSIC, FILM or SPEECH).

### **SURRND (Surround)**

Press this button to turn Surround Mode on or off.

### **MTS/SAP (Multichannel Television Sound/Second Audio Program)**

Press this button repeatedly to scroll through the available MTS settings (MONO, STEREO, SAP or Mono+SAP).

### **MUTE**

Press this button to mute the audio output.

## 12. Favorite Channel Selection Buttons

Use these buttons to select stored favorite channels. To store favorite channels, select Favorite Channel from the Channel menu (described in Section 4).

**Notes:**



# 3. Installation

## 3.1 Remote Control

### ◀ Battery Installation

To install batteries in the remote control:

1. Slide the battery cover in the direction of the arrow and remove it.
2. Insert the included batteries. Ensure that the polarities correctly match the ⊕ and ⊖ markings inside the battery compartment.
3. Slide the battery cover back on until it snaps into place.



#### **Note**

1. Do not mix an old battery with a new one or different types of batteries.

2. If you will not use the remote control for a long time, remove the batteries to avoid damage from battery leakage.

- Do not drop the remote control or expose it to moisture or high temperature.
- The remote control may malfunction under a fluorescent lamp. If that occurs, move the LCD display away from the fluorescent lamp.
- Make sure that there is nothing obstructing the infrared beam between the remote control and the IR receiver on the LCD display.

### ◀ Notes on Remote Control Operation



#### **Note**

The signal from the remote control can be reflected by walls or other surfaces.

- If the effective range of the remote control decreases, or it stops working, replace the batteries with new ones.
- Ambient conditions may possibly impede the operation of the remote control. If this happens, point the remote control at the LCD display and repeat the operation.

## 3.2 Quick Setup

Table 3-1 gives a quick overview of the Crystal Series LCD Display installation process. The sections following this one provide detailed instructions.



**Note**

*Installation should be performed by a qualified custom video installation specialist.*

**Table 3-1. Installation Overview**

Step	Procedure	For Details, refer to page...
1	Mount the Crystal Series LCD Display on a wall (optional)	15
2	Connect signal sources to the Crystal Series LCD Display	16
3	Connect external controller to RS-232 port (optional)	21
4	Apply power to the Crystal Series LCD Display	23
5	Change the OSD language	23
6	If using the Crystal Series LCD Display with a PC, adjust PC display properties	24
7	Display calibration: adjust the following <b>for each input</b> ; save settings when finished: <ul style="list-style-type: none"> <li>• Brightness</li> <li>• Contrast</li> <li>• Color level</li> <li>• Tint</li> <li>• Input position</li> </ul>	27 through 37

Proper installation of your Crystal Series LCD Display will ensure the highest possible picture quality. Whether you are installing the Crystal Series LCD Display temporarily or permanently, you should take the following into account to ensure that it performs optimally.

You can either place the Crystal Series LCD Display on a table or in an entertainment center, or mount it on a wall.

If you do decide to wall-mount the Crystal Series LCD Display, ensure that the wall-mount bracket is installed according to the instructions included with it. The wall must be capable of supporting a redundant weight factor three (3) times the weight of the display, or be reinforced.

Runco recommends that this be done by a custom installation specialist.



**Note**

*Use only the Runco-approved wall-mount kit designed for your display.*

In general, minimize or eliminate light sources directed at the display. Contrast ratio in your images will be noticeably reduced if light directly strikes the display, such as when a shaft of light from a window or floodlight falls on the image. Images may then appear washed out and less vibrant.

Other considerations and tips that can help improve your installation:

- Keep the ambient temperature constant and below 35°C (95°F). Keep the display away from heating and/or air conditioning vents. Changes in temperature may cause drifts in the display circuitry, which may affect performance.
- Keep the Crystal Series LCD Display away from devices that radiate electromagnetic energy such as motors and transformers. Common sources of these include slide projectors, speakers, power amplifiers and elevators.

### 3.3 Installation Considerations

#### ◀ **Wall-Mounting the Crystal Series LCD Display**

#### ◀ **Ambient Light**

#### ◀ **Other Considerations**

### 3.4 Connections to the Crystal Series LCD Display

Proceed as follows to connect the Crystal Series LCD Display to your video sources, external controller(s) – if present – and AC power.

When connecting your equipment:

- Turn off all equipment before making any connections.
- Use the correct signal cables for each source.
- Ensure that the cables are securely connected. Tighten the thumbscrews on connectors that have them.
- Use the left audio input when connecting mono audio sources.

**Rear Connector Access** ➤ To access the left rear connector panel, push down on the plastic clip holding the cover in place. Then, pull firmly on the cable access cover to open it.

**Connecting the Crystal Series LCD Display to Source Components** ➤ Connect your video sources to the Crystal Series LCD Display as shown and described in the sections that follow.

**Antenna/Cable TV Connection:** Connect your antenna or cable television source to the ANT jack on the rear of the Crystal Series LCD Display; see Figure 3-1.

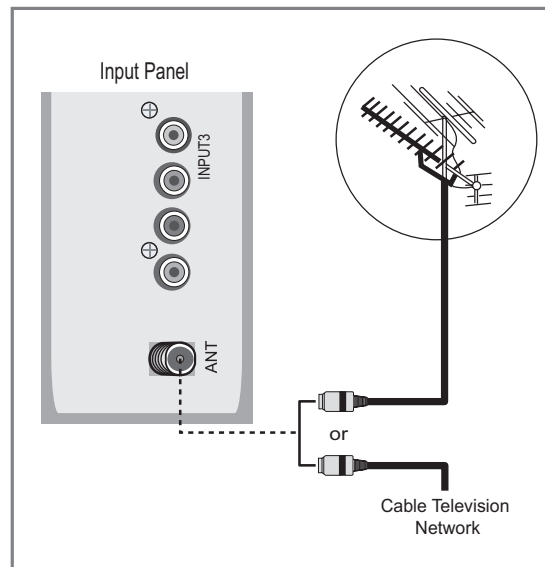

**Figure 3-1. Antenna/Cable TV Connection**

**DVI Connections:** The Crystal Series LCD Display has a DVI input for connecting a DVD player, DTV decoder, personal computer or any other device with a DVI or HDMI output. Connect such devices as shown in Figure 3-2.



*Use the DVI inputs whenever possible. This ensures the highest video quality because the signal is carried in the digital domain throughout the entire signal path, from source component output into the display.*



**Note**

This Crystal Series LCD Display supports the VESA Display Data Channel (DDC) standard. This standard provides “Plug and Play” capability; the display and a VESA DDC-compatible computer communicate their setting requirements, allowing for quick and easy setup.

In order for Plug and Play to work correctly, you must turn on the display before you turn on the connected computer.

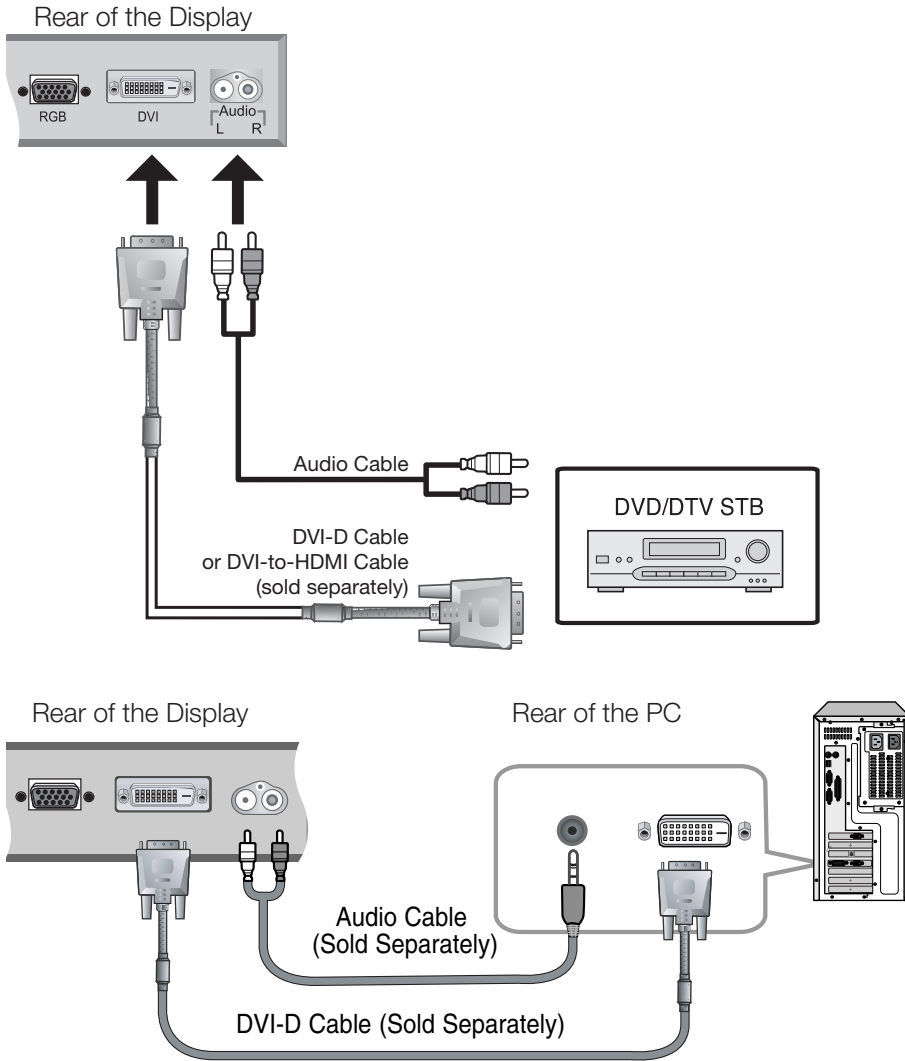

**Figure 3-2. DVI Connections**

**RGB Connections:** The Crystal Series LCD Display has an RGB input for connecting a personal computer; see Figure 3-3.

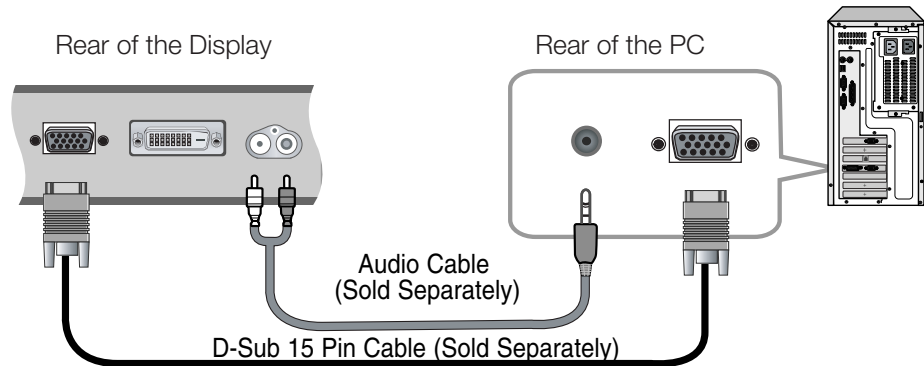

**Figure 3-3. Analog RGB Connections**



**Note**

1. Refer to **Computer/Video Signal Compatibility** on page 56 for a list of computer signals compatible with the Crystal Series LCD Display. Use with signals other than those listed may cause some functions not to work.
2. Some Macintosh computers may require a Macintosh video adapter. Contact your nearest authorized service center or dealer.
3. This Crystal Series LCD Display may not be able to display images from notebook computers in simultaneous (CRT/LCD) mode. Should this occur, switch the notebook computer to “CRT only” mode. If you are unsure how to do this, refer to your notebook computer’s user manual.

**Component Video Connections:** If you have a DVD player or DTV decoder with a component (YPbPr) output, connect it to INPUT 3 of the Crystal Series LCD Display as shown in Figure 3-4.

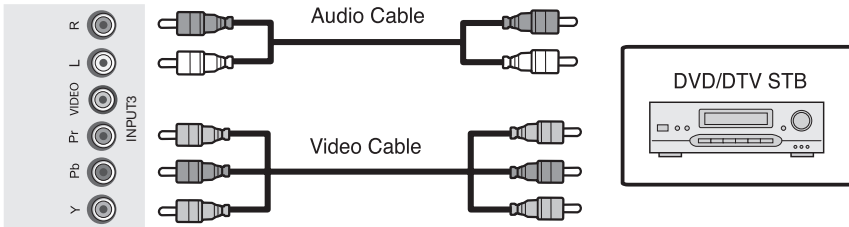

**Figure 3-4. Component Video Connections**

**Composite/S-Video Connections:** The Crystal Series LCD Display has two (2) S-Video and three (3) composite video inputs for connecting a VCR, camcorder, laser disc player or DVD player; see Figure 3-5.

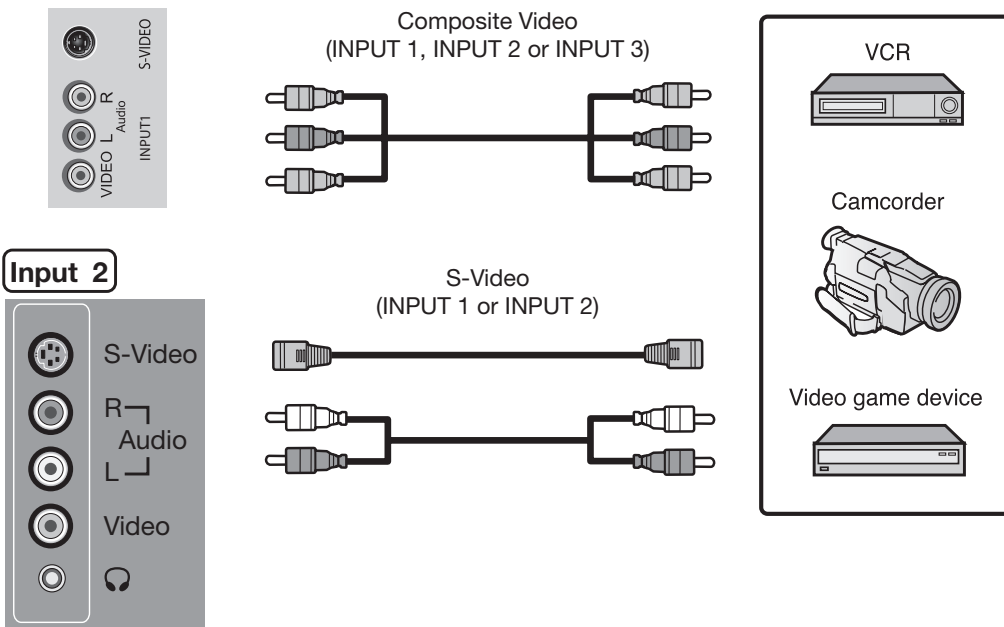
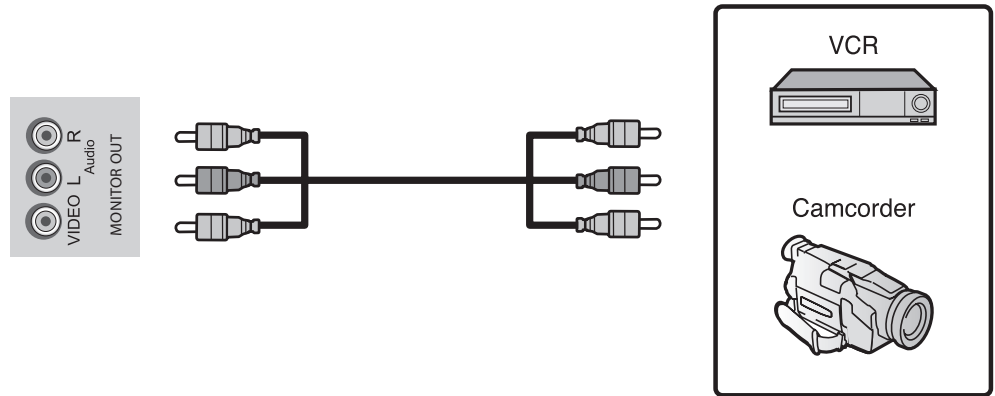

**Figure 3-5. Composite and S-Video Connections**

**MONITOR OUT Connection** ➤

The Crystal Series LCD Display has a monitor out feature for connecting a second VCR or other auxiliary equipment. Connect the MONITOR OUT audio and video jacks to the audio and video inputs of the VCR or other equipment as shown in Figure 3-6.

You can route either the main or picture-in-picture (PIP) source signal to the monitor outputs. For more information, refer to **Monitor Out** on page 37.



**Figure 3-6. Monitor Output Connections**

**Connecting Headphones** ➤

You can connect a set of headphones to the Crystal Series LCD Display to watch a program without disturbing others. Connect them to the headphone output located at INPUT 2; see Figure 3-7.

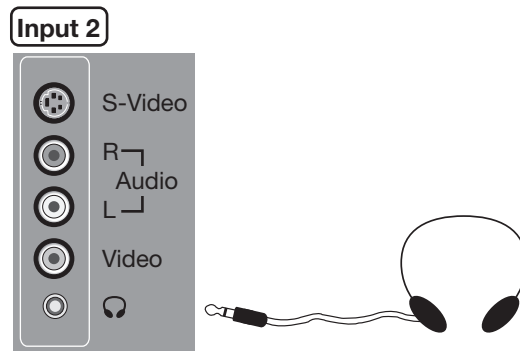

**Figure 3-7. Connecting Headphones**



Use a “null-modem” RS-232 cable with a 9-pin female connector to connect a PC or home theater control/automation system (if present) to the RS-232 port on the Crystal Series LCD Display; see Figure 3-8.

◀ **RS-232 Controller Connection**

For more information about using this connection, refer to **Serial Communications** on page 49.

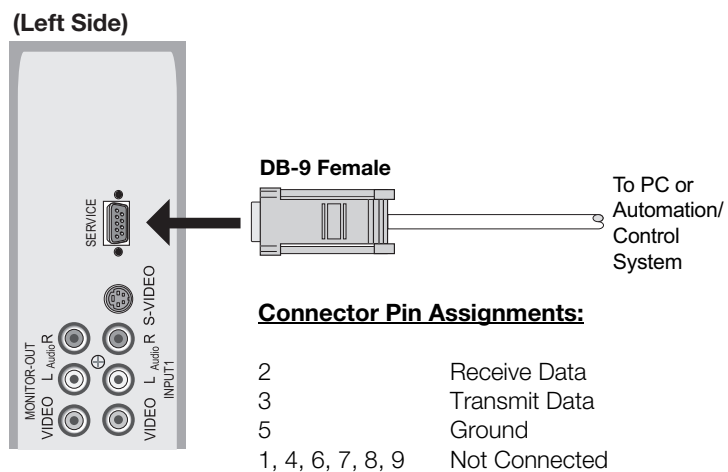

**Figure 3-8. RS-232 Control System Connection**

**Notes:**

# 4. Operation

---

1. Turn on your source components.
2. Plug the female end of the power cord into the AC receptacle on the rear of the Crystal Series LCD Display (AC 100V ~ 240V).
3. Connect the other end to your AC power source.
4. Turn on the main power switch at the rear of the display (CR-32HDI only).
5. The power indicator lights red to indicate that the Crystal Series LCD Display is in “standby” mode.
6. Press the **ON** button on the remote control to turn on the display (or press the power button on the front of the display). The power indicator flashes for a few seconds, then lights solid green.
7. After a brief warm-up period (approximately 10 seconds), the Crystal Series LCD Display will display an image.

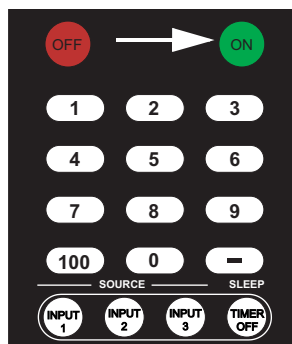

---

## 4.1 Turning on the Power

The Crystal Series LCD Display OSD language is initially set to English, but can also display the menus in French, Spanish, Portuguese or German. To change the OSD language:

1. Press **MENU**.
2. Select **Setup** from the Main Menu.
3. Select **OSD Language** from the Setup Menu.
4. Press **▲** or **▼** to highlight the desired language and press **ENTER**. The change takes effect immediately.

---

## 4.2 Changing the OSD Language

### 4.3 Setting the PC Display Properties

To maximize image quality when using the Crystal Series LCD Display with a personal computer, you may need to adjust the display properties of your PC video card. To do this:

1. Choose Settings from the Windows Start menu and click on "Control Panel."

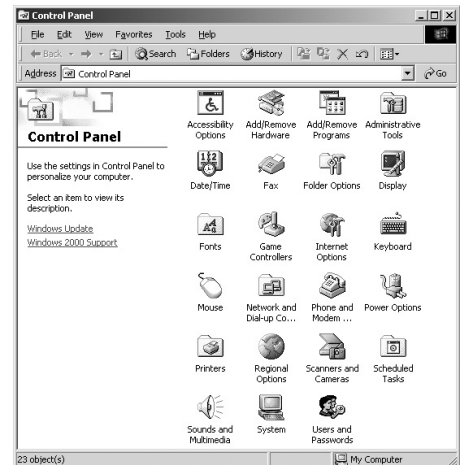

2. Double click on the **Display** icon.
3. Click the **Settings** tab on the display dialog box.
4. Adjust the resolution to 1024x768 pixels.

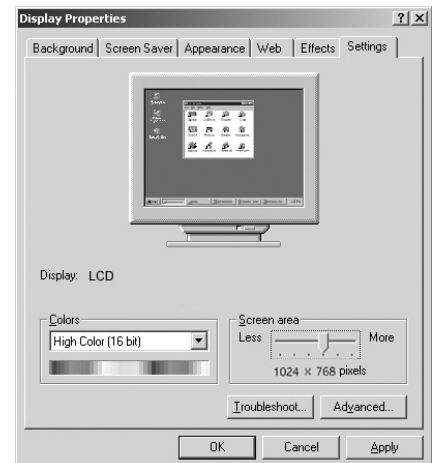

5. Click the **Advanced** button and click the **Monitor** tab on the dialog box. Set the vertical frequency to 60Hz and click **OK**.



**Note**

1. The maximum available resolution and vertical frequency is 1024x768 at 75Hz or the maximum supported by your video card, whichever is lower. You can get the best picture at 1024x768/60Hz.
2. The Crystal Series LCD Display supports 24-bit color (16,777,216 possible colors).

To use the on-screen menus:

1. Press **MENU** to display the Main Menu.
2. To select a menu item, use the up- or down-arrow buttons (▲, ▼) on the remote control to highlight it.
3. Press **ENTER** or the right-arrow button (▶) to access that menu.
4. Use the up- or down-arrow buttons (▲, ▼) to select the setting you want to change. Then, press **ENTER** or the right-arrow button (▶).
5. Press the right- or left-arrow button (◀, ▶) to change that setting.
6. To return to the previous menu, press **MENU**.

The Crystal Series LCD Display OSD menus are arranged hierarchically, as shown in Figure 4-1. Depending on the selected input source and/or signal characteristics, some menu options may not be available.

---

## 4.4 Using the On-Screen Menus

<b>Source</b>	TV		
	Input 1		
	Input 2		
	Input 3		
	DVI		
<b>Aspect Ratio</b>	RGB		
	Anamorphic		
	Standard		
	Letterbox		
	VirtualWide		
<b>Picture Adjust</b>	Brightness	0 ... 100	
	Contrast		
	Color		
	Tint		
	Sharpness		
	Color Temp.	5400, 6500, 8500 or Custom	
	Backlight	0, 5, 10, 15, 20, ... 100	
	Save Settings (not available on RGB input)	Custom	
<b>Audio</b>	Restore Settings (not available on RGB input)	Custom, ISF Day, ISF Night	
	Balance	L10, L9, L8 ... 0 ... R8, R9, R10	
	Equalizer	Standard, Music, Film, Speech or Custom	
	Surround	(On/Off)	
	Audio Language	English, Français, Español or Português	
<b>Channel</b>	TV Speaker	(On/Off)	
	Auto Tuning	AIR	
		CABLE (STD / IRC / HRC)	
Return			
<b>Timer</b>	Add/Erase		
	Favorite Channel		
	Time	12:00 AM - 11:59 PM	
	On Timer	Enable/Disable, Time, Channel, Volume	
	Off Timer	Enable/Disable, Time	
	Sleep Timer	Off, 10, 30, 60, 120 or 180 minutes	
Time Zone	Eastern, Central, Mountain or Pacific		
<b>Setup</b>	OSD Language	English, Français, Español, Português or Deutsch	
	PC Mode Adjust	Auto Adjust	
		H. Position	
		V. Position	
		H. Size	
		Phase	
	Caption	Display (On/Off), Mode, CC On Mute (Yes/No)	
	Parental Control	Parental Lock (On/Off), TV Rating, Movie Rating, Unrated (Allow/Block), Change PIN (default is 0000)	
	Letterbox Mode	Standard or Cinema Fill	
	Input Selection	Input 1/Input 2: Video or S-Video Input 3: Video or Component	
	Monitor Out	Main or PIP: Video	
	Overscan (not available on RGB input)	H. Overscan, H. Shift, V. Overscan, V. Shift	
	<b>ISF Calibration</b>	Picture Adjust	Brightness
			Contrast
			Color
Tint			
Sharpness			
Color Temp.			5400, 6500, 8500 or Custom
Backlight		0, 5, 10, 15, 20, ... 100	
Save Settings (not available on RGB input)		ISF Night, ISF Day, Custom	
White Balance		R/G/B Gain	
		R/G/B Offset	
Blue Enable		(Enable/Disable)	
DNR		0, 10, 20, ... 100	
Gamma		2.0, 2.2 or 2.4	
Baud Rate		115200, 19200, 9600 or 2400	
Command Ack		(On/Off)	
Factory Reset			
Splash Duration	0, 1, 2, 3, ... 60 secs.		

Figure 4-1. Crystal Series LCD Display OSD Menu Structure

The Main Menu is the starting point for accessing all Crystal Series LCD Display functions. (The ISF Calibration menu is not accessible until you enter a passcode.)

◀ **Main Menu**

<b>Runco CR-26HD</b>
<b>Source</b>
Aspect Ratio
Picture Adjust
Audio
Channel
Timer
Setup
ISF Calibration

From the Main Menu, select Source to choose a video signal source.

The active source is indicated by a green square (■) to its left; in this example, TV is the active source.

◀ **Source**

■	<b>TV</b>
	Input1
	Input2
	Input3
	DVI
	RGB

To change the aspect ratio (size and shape) of the projected image, select Aspect Ratio from the Main Menu and press **ENTER**. Select the appropriate aspect ratio for the type of program material being viewed; refer to Table 4-1.

The currently-selected aspect ratio is indicated by a green square (■) to its right; in this example, Anamorphic is selected.

◀ **Aspect Ratio**

■	<b>Anamorphic</b>
	Standard
	Letterbox
	VirtualWide



**Note**

*The aspect ratio selection persists until you change it. (It is not saved independently for each input.)*

**Table 4-1. Aspect Ratio Settings**

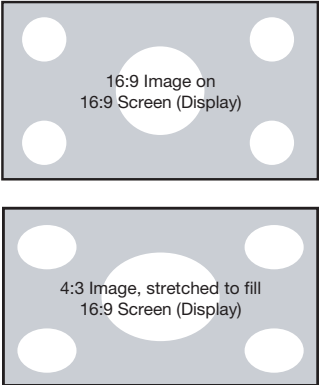
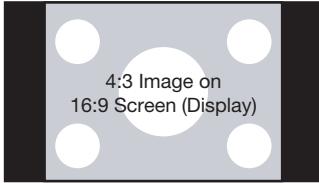
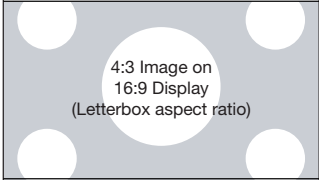
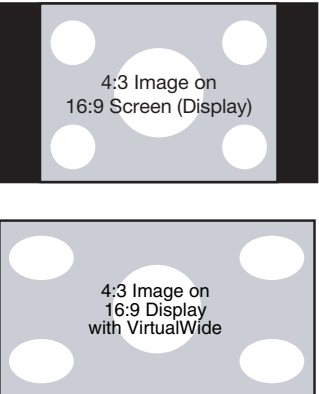
Aspect Ratio	Remote Control Key	Description	
Anamorphic	ANA	 <p>16:9 Image on 16:9 Screen (Display)</p> <p>4:3 Image, stretched to fill 16:9 Screen (Display)</p>	<p>Select Anamorphic to view 16:9 DVDs and HDTV programs in their native aspect ratio.</p> <p>4:3 images are stretched horizontally to fit a 16:9 display.</p>
Standard	4X3	 <p>4:3 Image on 16:9 Screen (Display)</p>	<p>Standard 4:3 scales the input signal to fit in the center of a 16:9 display. 4:3 is the aspect ratio used by computer monitors, standard television programming and most VHS video cassettes.</p>
Letterbox	LET BOX	 <p>4:3 Image on 16:9 Display (Letterbox aspect ratio)</p>	<p>Letterbox mode scales (zooms in on) a 4:3 image linearly (by the same amount on all sides) to fill a 16:9 display. Letterbox is best suited for viewing LaserDisc movies or non-anamorphic DVDs on a 16:9 screen.</p>
VirtualWide	VWIDE	 <p>4:3 Image on 16:9 Screen (Display)</p> <p>4:3 Image on 16:9 Display with VirtualWide</p>	<p>VirtualWide scales a 4:3 image NON-linearly (more on the sides than in the center) to fit a 16:9 screen.</p>



Use the controls in the Picture Adjust menu to calibrate your Crystal Series LCD Display for optimum picture quality.

The Crystal Series LCD Display has been designed to incorporate setup and calibration standards established by the Imaging Science Foundation (ISF). The ISF has developed carefully crafted, industry-recognized standards for optimal video performance and has implemented a training program for technicians and installers to use these standards to obtain optimal picture quality from Runco video display devices. Accordingly, Runco recommends that setup and calibration be performed by an ISF-certified installation technician.

All signal types require separate processing. Therefore, you need to calibrate each input separately.

◀ **Picture Adjust**

<b>Picture Adjust</b>
<b>Brightness</b>
<b>Contrast</b>
<b>Color</b>
<b>Tint</b>
<b>Sharpness</b>
<b>Color Temp.</b>
<b>Backlight</b>
<b>Save Settings</b>
<b>Restore Settings</b>



**Note**

*When you change a picture quality setting, save the change to a preset afterwards. Otherwise, the change will be lost when a different input is selected. (Picture quality settings are saved for each input and **resolution** separately.) For information about saving settings, refer to **Save Settings (not available for RGB input)** on page 33.*

Although it may be possible to obtain satisfactory picture quality using the naked eye and regular program material, Runco recommends using the following calibration tools for best results:

- External test pattern source – Ovation Multimedia, Digital Video Essentials or AVIA test DVD or equivalent.
- A blue filter (provided with many test DVDs), for color level and tint adjustments.

Connect your test pattern source to the input that you are calibrating and proceed as follows. **Perform the adjustments in the order listed here.**

**Brightness:** On your external test pattern source, select a PLUGE pattern. (PLUGE is an acronym for “Picture Line-Up Generation Equipment.”) Figure 4-2 shows a typical PLUGE pattern.

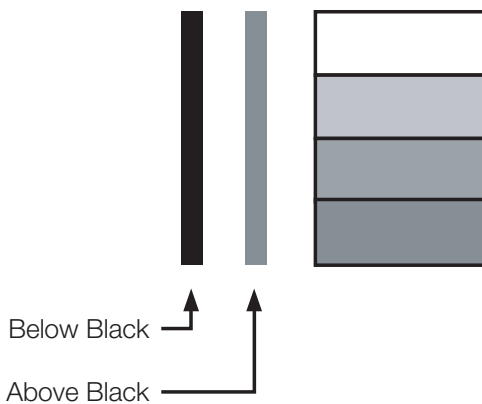

**Figure 4-2. Typical PLUGE Pattern for Adjusting Brightness**

PLUGE patterns vary but generally consist of some combination of black, white and gray areas against a black background. The example above includes two vertical bars and four shaded boxes.

Select Brightness from the Picture Adjust menu. Using the left- and right-arrow ( ◀ ▶ ) buttons, adjust the brightness so that:

- The darkest black bars disappear into the background.
- The dark gray areas are barely visible.
- The lighter gray areas are clearly visible.
- The white areas are a comfortable level of true white.
- The image contains only black, gray and white (no color).

**Contrast:** On your external test pattern source, select a stepped, gray-bar pattern like the one shown in Figure 4-3.



**Figure 4-3. Typical Gray Bar Pattern for Adjusting Contrast**

Select Contrast from the Picture Adjust menu. Using the left- and right-arrow ( ◀ ▶ ) buttons, adjust the contrast to a point just below which the white rectangle starts to increase in size.



**Note**

*Brightness and contrast controls are interactive. A change to one may require a subtle change to the other in order to achieve the optimum setting.*

**Color Saturation:** On your external test pattern source, select a color bar pattern like the one shown in Figure 4-4.

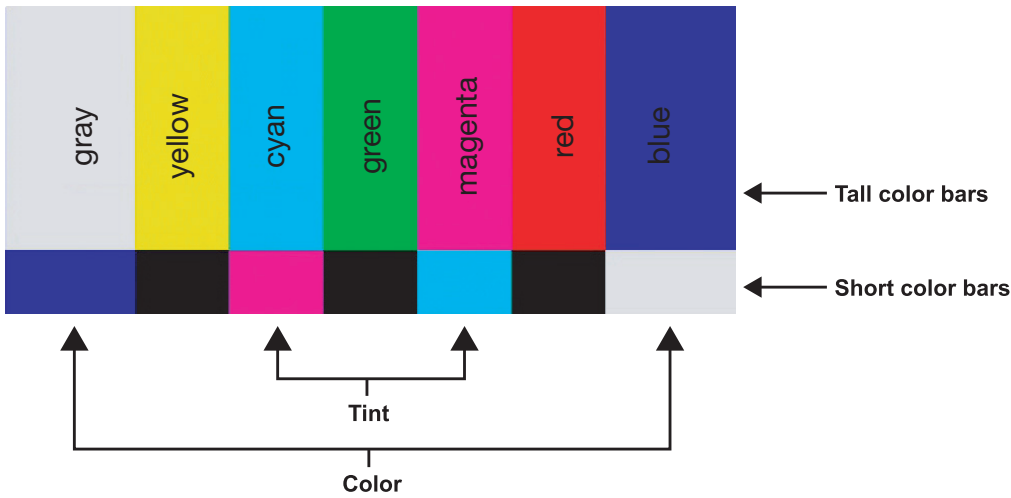

**Figure 4-4. Typical Color Bar Pattern for Adjusting Color Saturation and Tint**

Select Color from the Picture Adjust menu. While looking at the color bar pattern through a blue filter, adjust the color saturation level until the outermost (gray and blue) color bars appear to be a single shade of blue:

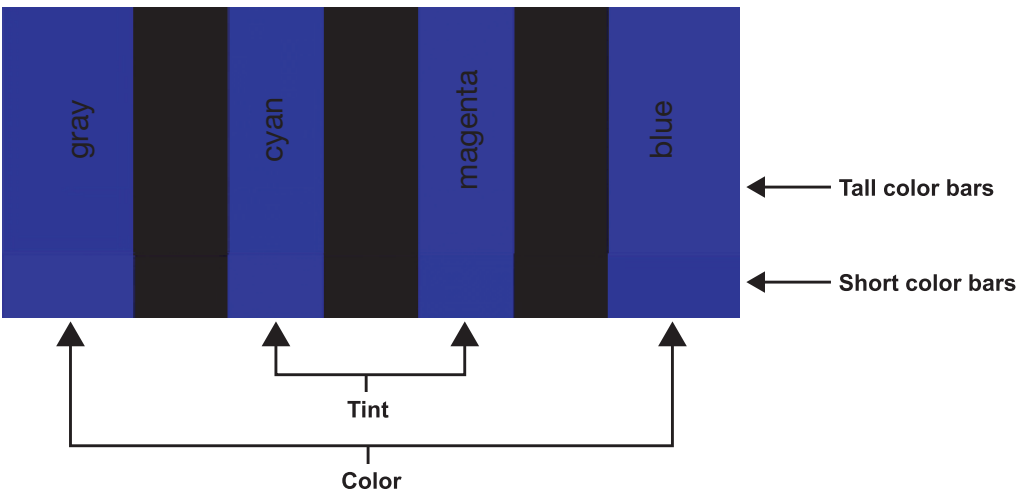

**Tint:** Tint or “hue” is essentially the ratio of red to green in the color portion of the image. When tint is decreased, the image appears redder; when it is increased the image appears greener. To set the tint, select Tint from the Picture Adjust menu. While looking at the color bar pattern through a blue filter, adjust the tint level until the cyan and magenta color bars (on either side of the green bar) appear to be a single shade of blue.



**Note**

*Like the brightness and contrast controls, the color and tint controls are interactive. A change to one may require a subtle change to the other in order to achieve the optimum setting.*

**Sharpness:** “Sharpness” is the amount of high-frequency detail in the image. To adjust sharpness, select Sharpness from the Picture Adjust menu and press **ENTER**. On your external test pattern source, select a pattern like the one shown in Figure 4-5. Adjust as needed, looking for white edges around the transitions from black to gray and different sized lines in the “sweep” patterns at the top and bottom. Lower the sharpness setting to eliminate them.

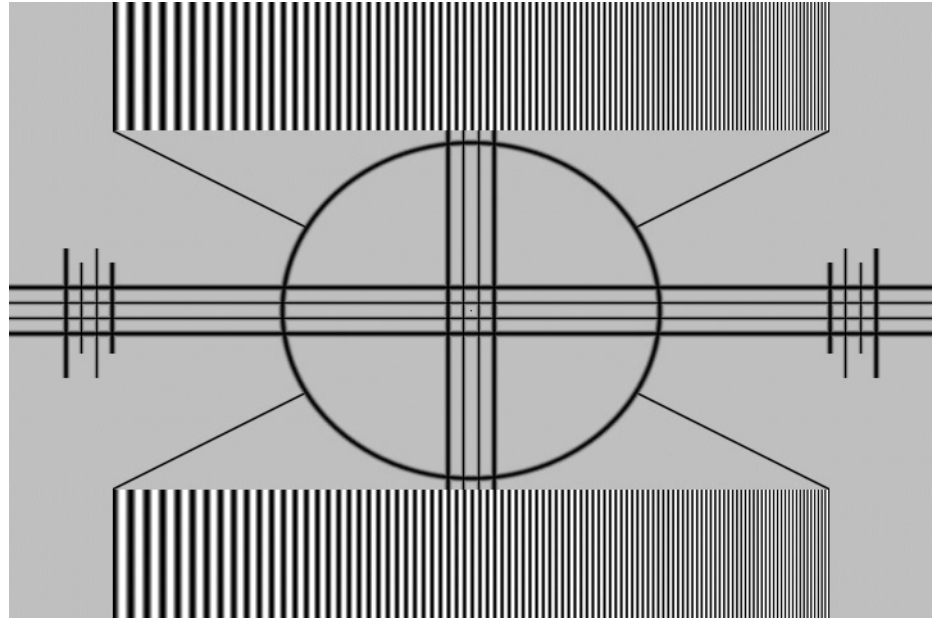

**Figure 4-5. Typical Test Pattern for Adjusting Sharpness**

**Color Temperature:** To adjust the color temperature, select Color Temp. from the Picture Adjust menu and press **ENTER**. (Color temperature defines the “color of gray.”) The choices are 5400K, 6500K, 8500K and Custom. The default setting, 6500K, is appropriate for most situations. Higher settings produce a “bluer” picture; lower ones impart a reddish hue to the image.

**Backlight:** The Backlight control changes the apparent brightness of the displayed image. Its effect is similar to that of a lamp intensity control on a projector.

**Save Settings (not available for RGB input):** The Crystal Series LCD Display lets you save image quality settings for each input and supported resolution to a preset. You can recall this preset at a later time by simply pressing a button on the remote control or using the Restore Settings menu command (see below).

You should save changes to any of the following settings to a preset; otherwise they will be lost when a new input source or resolution is selected:

- Brightness
- Contrast
- Color saturation
- Tint
- Sharpness
- Gamma
- Color temperature and white balance

**Restore Settings (not available for RGB input):** To recall a preset, choose Restore Settings from the Picture Adjust menu and select “Custom,” “ISF Day” or “ISF Night.” Or, use the corresponding buttons on the remote control.

To adjust the Crystal Series LCD Display audio settings, select Audio from the Main Menu and press **ENTER**.

**Balance:** To adjust the left/right speaker balance, select Balance from the Audio Menu and press **ENTER**. Use the left- and/or right-arrow buttons to make one channel louder than the other.

**Equalizer:** The Crystal Series LCD Display has a five-band graphic equalizer that you can use to boost or cut certain audio frequencies. To use it, select Equalizer from the Audio menu and press **ENTER**. Select one of four equalizer presets – Standard (flat), Music, Film or Speech – or select Custom to create your own according to taste. The five frequency bands are 100, 300, 1000, 3000 and 10,000 Hertz (Hz).

**Surround:** The Crystal Series LCD Display has a “surround sound” mode that simulates a multi-channel sound system. To use the surround mode, select Surround from the Audio menu and set it to On.

◀ **Audio**

<b>Audio</b>
<b>Balance</b>
<b>Equalizer</b>
<b>Surround</b>
<b>Audio Language</b>
<b>TV Speaker</b>



**Note**

*When Surround is set to On, the graphic equalizer is disabled.*

**Audio Language:** Some digital TV broadcasts provide audio soundtracks in multiple languages. If you are watching such a program, select Audio Language from the Audio menu to choose a soundtrack language: English, Français, Español or Português.

**TV Speaker:** To disable the internal speakers, select TV Speaker from the Audio menu, set it to Off and press **ENTER**. The effect is similar to using the **MUTE** button, except that the Crystal Series LCD Display “remembers” this setting if you turn off the display, then turn it back on.

**Channel** ➤

Channel
Auto Tuning
Add/Erase
Favorite Channel

To set up the Crystal Series LCD Display channel tuner, select TV as the source. Then, select Channel from the Main Menu and press **ENTER**.

**Auto Tuning:** To have the Crystal Series LCD Display automatically detect available TV or CATV channels, select Auto Tuning and press **ENTER**.

- **Off-Air Channels:** If you are using an off-air antenna, select AIR and press **ENTER** again. The Crystal Series LCD Display searches all channel frequencies and adds a channel to its memory when it detects a signal on that channel frequency. (This may take a few minutes.)
- **CATV Channels:** If you are using cable, select CABLE and press **ENTER**. Then, select STD and press **ENTER** again. The Crystal Series LCD Display searches all channel frequencies and adds a channel to its memory when it detects a signal on that channel frequency. (This may take a few minutes.) If Auto Tuning fails to detect any CATV channels, select HRC or IRC and try again. (STD, HRC and IRC refer to different sets of frequencies used by cable television providers. IRC stands for “Incrementally Related Carrier;” HRC stands for “Harmonically Related Carrier.”)

**Add/Erase:** If Auto Tuning fails to detect a channel, select Add/Erase from the Channel menu, then select Add to add it to the channel list. To erase the currently-selected channel from the available channel list, select Add/Erase from the Channel menu, then select Erase.

**Favorite Channel:** You can specify up to four channels as “favorite” channels that can be accessed by pressing a single button on the remote, instead of manually entering the channel number. To do this, select Favorite Channel from the Channel menu and press **ENTER**.

Use the up- or down-arrow button to select the memory location in which you want to store the favorite channel. Then, use the left- or right-arrow button to specify the channel number.

To recall a favorite channel, press the corresponding button on the remote control (FC1, FC2, FC3 or FC4).

**Timer** ➤

Timer
Time
On Timer
Off Timer
Sleep Timer
Time Zone

To set the Crystal Series LCD Display internal clock or configure the on/off timers, select Timer from the Main Menu and press **ENTER**.

**Time:** To set the Crystal Series LCD Display internal clock, select Time from the Timer menu and press **ENTER**. Use the up- or down-arrow button to select either the hour of the day or the minute of the hour to set. Then, use the left- or right-arrow buttons to set that component of the time. When finished, press **MENU**.

**On Timer:** Use the On Timer to turn the Crystal Series LCD Display on at a specific time of day. You can also specify a channel and a volume level.

**Off Timer:** Use the Off Timer to turn the Crystal Series LCD Display off at a specific time of day.

**Sleep Timer:** Use the Sleep Timer to turn off the Crystal Series LCD Display after a specified interval.

To set the Sleep Timer:

- Select Sleep Timer from the Timer menu and press **ENTER**. Use the right- or left-arrow button to select 10, 30, 60, 120 or 180 minutes. Then, press **MENU**.

– OR –

- Press the **TIMER OFF** button on the remote control repeatedly to select the desired timer interval.

**Time Zone:** To set the local (North American) time zone, select Time Zone from the Timer menu and press **ENTER**. Use the up- or down-arrow button to select Eastern, Central, Mountain or Pacific. Press **ENTER** to confirm your selection.

Use the controls in the Setup menu to perform advanced image quality adjustments and access various other Crystal Series LCD Display features.

**OSD Language:** Select OSD Language from the Setup menu and press **ENTER**. Then, use the up- or down-arrow buttons to select the OSD language (English, French, Spanish, Portuguese or German). Press **ENTER** again to confirm your selection.

**PC Mode Adjust:** To improve the quality of projected images from a computer or other VESA-compliant, RGB source, select PC Mode Adjust and press **ENTER**.

- **Auto Adjust:** Auto Adjust automatically adjusts settings to optimize computer images. To execute Auto Adjust on command, select Auto Adjust and press **ENTER**.



**Note**

*Auto Adjust may take some time to complete, depending on the characteristics of the incoming signal.*

- **H Position:** Use the up- or down-arrow buttons (▲, ▼) to highlight H Position. Then, use the right-arrow button (▶) to shift the image to the right; use the left-arrow button (◀) to shift the image to the left.
- **V Position:** Use the up- or down-arrow buttons (▲, ▼) to highlight V Position. Then, use the right-arrow button (▶) to shift the image up; use the left-arrow button (◀) to shift the image down.
- **H Size:** Use the up- or down-arrow buttons (▲, ▼) to highlight H Size. Then, use the right-arrow button (▶) to increase the width; use the left-arrow button (◀) to decrease it.
- **Phase:** Adjust the phase if the image shows shimmer or “horizontal” noise. Pixel phase adjusts the phase of the pixel sampling clock relative to the incoming signal. The effect of this control is similar to that of a tracking control on a VCR.

For best results, use a good test pattern such as a smooth gray consisting of a clear pattern of black and white pixels, or a similar “half on, half off” graphic image. (You may notice that you can stabilize the image at more than one point. Use either setting in this case.)

To restore the factory-default Position, Size and Phase settings, select Factory Preset and press **ENTER**.

◀ **Setup**

<b>Setup</b>
<b>OSD Language</b>
<b>PC Mode Adjust</b>
<b>Caption</b>
<b>Parental Control</b>
<b>Letterbox Mode</b>
<b>Input Selection</b>
<b>Monitor Out</b>
<b>Overscan</b>

**Caption:** Select Caption from the Setup menu to control the display of closed captions when watching programs that contain them.

- **Display:** Select On or Off to control the display of closed captions.
- **Mode:** Select one of four captioning modes: CC1, CC2, CC3 or CC4. CC1 usually contains the native-language captions; if a program is captioned in more than one language, those captions are carried on CC2, CC3 or CC4.

The Crystal Series LCD Display also supports “text mode” captioning; to use this feature, select Text1, Text2, Text3 or Text4. The text modes, instead of displaying a few lines of captions somewhere on the picture, take over all or half of the screen to display scrolling text information. (The text modes are seldom used today, so most of the time there is no information there to see.) The text field is sometimes used for embedding Internet data (called Interactive TV Links, or ITV Links) in the captions.

- **CC On Mute:** To have the Crystal Series LCD Display show captions when the audio output is muted, set this option to Yes.

**Parental Control:** To block the display of television programs or movies based on their ratings, select Parental Control from the Setup menu and press **ENTER**. Enter the default Personal Identification Number (PIN) – **0000** – and press **ENTER** again.

- **Parental Lock:** This is the “master switch” for the parental controls. Set it to On or Off.
- **TV Rating:** Select TV Rating from the Parental Control menu to block television programs carrying a given rating, to prevent children from watching programs that are deemed inappropriate. These ratings and content labels have been established by the United States Federal Communications Commission (FCC) to help parents and other caregivers determine if a program is suitable for young viewers.

To block programs carrying a given rating, use the up- or down-arrow to select a rating. Then, press the right-arrow button to require the PIN code to be entered to view a program with that rating. A lock icon  appears to indicate that the restriction is active.

Table 4-2 describes the TV ratings and content categories. For more information, visit [http://www.fcc.gov/parents/parent\\_guide.html](http://www.fcc.gov/parents/parent_guide.html).

**Table 4-2. FCC Ratings and Content Categories**

Rating/Category	Description
TV-MA	Mature Audience Only - graphic violence, explicit sexual content and/or offensive language.
TV-14	Parents strongly cautioned - intense violence, sexual situations, coarse language and/or suggestive dialogue.
TV-PG	Parental guidance suggested - violence, sexual situations, coarse language and/or suggestive dialogue.
TV-G	General audience - suitable for children and adults.
TV-Y7	Children 7 and up.
TV-Y	Suitable for all children.
FV	Fantasy violence or cartoon violence.
D	Sexual dialogue.



**Table 4-2. FCC Ratings and Content Categories (continued)**

Rating/Category	Description
L	Offensive language
S	Sexual content
V	Violence

- **Movie Rating:** Select Movie Rating from the Parental Control menu to block movies carrying a given rating, to prevent children from watching movies that are deemed inappropriate. These ratings have been established by the Motion Picture Association of America (MPAA) to help parents and other caregivers determine if a movie is suitable for young viewers.

To block movies carrying a given rating, press the right-arrow button to require the PIN code to be entered to view a movie with that rating. A lock icon (🔒) appears to indicate that the restriction is active.

For more information on movie ratings, please visit <http://www.mpa.org/movieratings/>.

- **Unrated:** To allow or block access to unrated content, select Unrated from the Parental Control menu and select Allow or Block. Press **ENTER** to confirm your choice.
- **Change PIN:** The default PIN for accessing the parental controls or bypassing content restrictions is **0000**. Runco recommends changing this to something less obvious.

**Letterbox Mode:** Select Letterbox Mode from the Setup menu to change the appearance of movies in Letterbox format.

When you select Standard, the original Letterbox format of the source is maintained. Black bars appear above and below the active image area.

When you select Cinema Fill, a 2.35 image is stretched vertically in both directions to fill a 16:9 display.

**Input Selection:** Input 1 and Input 2 have both S-Video and composite video connectors. Input 3 has both component and composite video connectors.

To specify which connection type you are using – or to switch from one to the other if equipment is connected to both – select Input Selection from the Setup menu and press **ENTER**.

**Monitor Out:** If you have equipment connected to the MONITOR OUT, select Monitor Out from the Setup menu to route either the main or PIP audio/video signals to that output.

**Overscan (not available for RGB input):** Overscan pushes the outside edge of the active picture area of the video signal out beyond the edge of the display area.

Some television programs are produced based on the assumption that older television sets may not display the outer edges of the broadcast picture area. Overscan effectively trims away these inactive, outer edges and enlarges the remaining portion of the image to fill the display area.

Use the on-screen slidebars to set the desired amount of horizontal and vertical overscan, as well as horizontal and vertical image shift.

These settings only affect 480i source material. For HDTV, DVDs and other video sources, Overscan is generally not necessary or desirable.

**ISF Calibration** ➤

Use the ISF Calibration menu to perform advanced picture quality adjustments. **This menu should be used by ISF-certified technicians only.**

<b>ISF Calibration</b>
<b>Picture Adjust</b>
<b>White Balance</b>
<b>Blue Enable</b>
<b>DNR</b>
<b>Gamma</b>
<b>Baud Rate</b>
<b>Command Ack</b>
<b>Factory Reset</b>
<b>Splash Duration</b>

**Note**

*You must enter a passcode to access the ISF Calibration menu.*

**Picture Adjust:** The controls in this menu are identical to those in the main Picture Adjust menu, but are accessible only by entering the ISF Calibration menu passcode. This makes it possible to restore the picture quality settings to what they were when the Crystal Series LCD Display was installed, simply by recalling the “ISF Night” or “ISF Day” preset.

- **Brightness:** Refer to **Brightness** on page 29.
- **Contrast:** Refer to **Contrast** on page 30.
- **Color:** Refer to **Color Saturation** on page 31.
- **Tint:** Refer to **Tint** on page 31.
- **Sharpness:** Refer to **Sharpness** on page 32.
- **Color Temp.:** Refer to **Color Temperature** on page 32.
- **Backlight:** Refer to **Backlight** on page 32.
- **Save Settings:** For each input and supported resolution, the Crystal Series LCD Display lets you save image quality settings as presets that you can recall at a later time. You can create up to three presets – designated “Custom,” “ISF Day” and “ISF Night” – per input and resolution.

You should save changes to any of the following settings to a preset; otherwise they will be lost when a new input source or resolution is selected:

- Brightness
- Contrast
- Color saturation
- Tint
- Sharpness
- Gamma
- Color temperature and white balance

To save image settings to a preset, select Save Settings from the ISF Calibration menu and select “Custom,” “ISF Day” or “ISF Night.”

**White Balance:** To remove any trace of color from the white areas of the projected image, choose White Balance from the Picture Adjust menu and press **ENTER**.

- **Gain:** Use the Gain controls to correct color imbalances in the bright areas of the image. A good way to do this is to use a test pattern consisting mostly of solid white areas, such as an 80 IRE “window” pattern. If the white areas contain traces of red, green or blue, decrease the Gain for that color.
- **Offset:** Use the Offset controls in the White Balance sub-menu to correct color imbalances in the dark areas of the image. A good way to do this is to use a test pattern consisting mostly of dark gray areas, such as a 30 IRE “window” pattern. If the gray areas contain traces of red, green or blue, decrease the Offset for that color.

White Balance		
R Gain		100
G Gain		100
B Gain		100
R Offset		50
G Offset		50
B Offset		50



**Note**

*Any white balance adjustments you make here are automatically stored as a “Custom” color temperature.*

**Blue Enable:** Blue Enable removes all red and green color information from the image, simulating a blue filter. You can use it instead of a blue filter when performing color and tint adjustments.

**DNR:** To apply Digital Noise Reduction (DNR) to the input signal, select DNR from the ISF Calibration menu. Noise reduction is useful for clearing up noisy RGB images such as those from a PC. Adjust as desired using the left- or right-arrow buttons, keeping in mind that reducing noise (which reduces high frequencies) may also “soften” the image.

**Gamma:** The Gamma control determines how gray shades are displayed between minimum input (black) and maximum input (white) for all signals. A good gamma setting helps to optimize blacks and whites while ensuring smooth transitions for the “in-between” values utilized in other grays.

Unlike brightness and contrast controls, Gamma allows you to lighten or darken the overall tone of your images without changing the extremes. All images will be more vibrant while still showing good detail in dark areas.

The default Gamma setting of 2.4 is appropriate for most typical home theater environments.

**Baud Rate:** Select Baud Rate from the ISF Calibration menu to set the data transfer rate of the Crystal Series LCD Display’s RS-232 SERVICE port. (This setting must match the data rate of the device connected to the RS-232 input.)

**Command Ack:** The Command Ack setting enables or disables the echo of serial commands at the source. When set to on, commands sent from the serial controller (PC or control/automation system) are logged and/or displayed on-screen. If this is not desired, set Command Ack to Off.

**Factory Reset:** To reset all Crystal Series LCD Display settings to their factory defaults, select Factory Reset from the ISF Calibration menu and press **ENTER**. ***This command is not undoable. Use it with caution!***

**Splash Duration:** Use Splash Duration to control how long the Crystal Series LCD Display splash screen remains on-screen after power-up; see Figure 4-6. To prevent this screen from appearing, set the Splash Duration to 0.



**Figure 4-6. Crystal Series LCD Display Splash Screen**

To use PIP, press the **PIP** (  ) button.

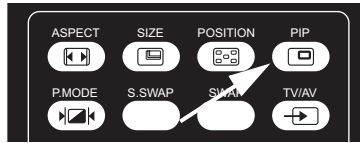

## 4.5 Using Picture-In-Picture (PIP)

The PIP window appears inside the main image window.

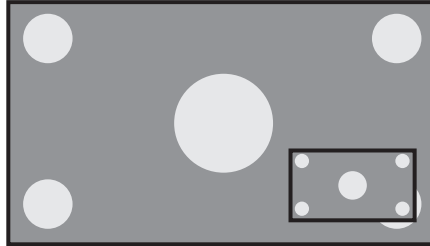

Press **PIP** again to switch to side-by-side PIP mode.

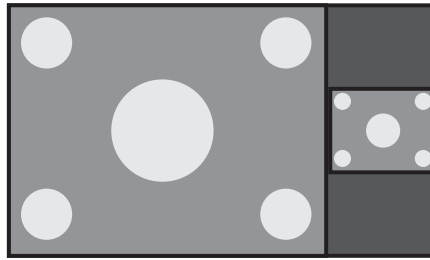

Press **PIP** again to turn PIP off.

Press the **TV/AV** button (  ) to select a PIP signal source. For each source, Table 4-3 shows which of the other sources are available as a PIP source.

**Table 4-3. Available Main and PIP Source Combinations**

Main	PIP	TV	INPUT1	INPUT2	INPUT3		PC	
					VIDEO	COMPONENT	RGB	DVI
	TV	X	X	X	X	X	X	X
	INPUT1	X	X	X	X	O	O	O
	INPUT2	X	X	X	X	O	O	O
INPUT3	VIDEO	X	X	X	X	X	O	O
	COMPONENT	X	O	O	X	X	X	O
PC	RGB	X	O	O	O	X	X	O
	DVI	X	O	O	O	O	O	X

*Notes:*

1. "O" means that that source is available as a PIP source when that input is selected; "X" means that it is not.
2. The Crystal Series LCD Display cannot display the same source in both the main and PIP windows, nor can it display RGB and component video simultaneously.

**Changing the PIP Position** ➤

To change the PIP window position, press the **POSITION** (  ) button on the remote control repeatedly until the window is in the desired position.

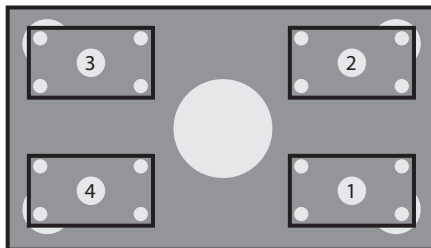
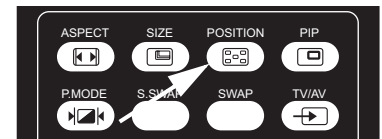

To change the PIP window size, press the **SIZE** () button on the remote control repeatedly to achieve the desired window size.

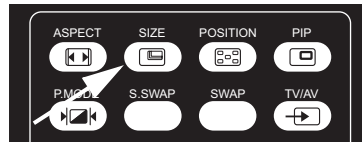
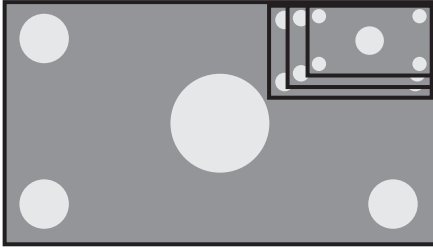

◀ **Changing the PIP Size**

To change the aspect ratio of the PIP window from 4:3 to 16:9 or vice versa, press the **ASPECT** () button on the remote control.

Refer to Table 4-1 for more information about aspect ratios.

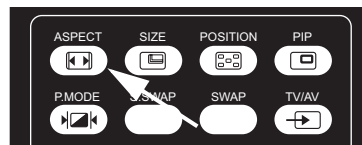

◀ **Changing the PIP Aspect Ratio**

To recall settings for the PIP input from either the “ISF Night” or “ISF Day” memory preset, press the **P.MODE** () button on the remote control.

Choose ISF Day when there is a lot of ambient light. Select ISF Night when there is low ambient light or at night.

To customize the ISF memory presets, refer to **ISF Calibration** on page 38.

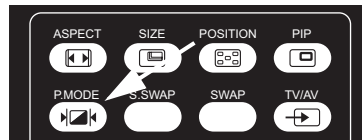

◀ **Changing the PIP Image Mode**

**Swapping the Main and PIP Images**

➤ To swap the main and PIP images, press the **SWAP** button on the remote control.

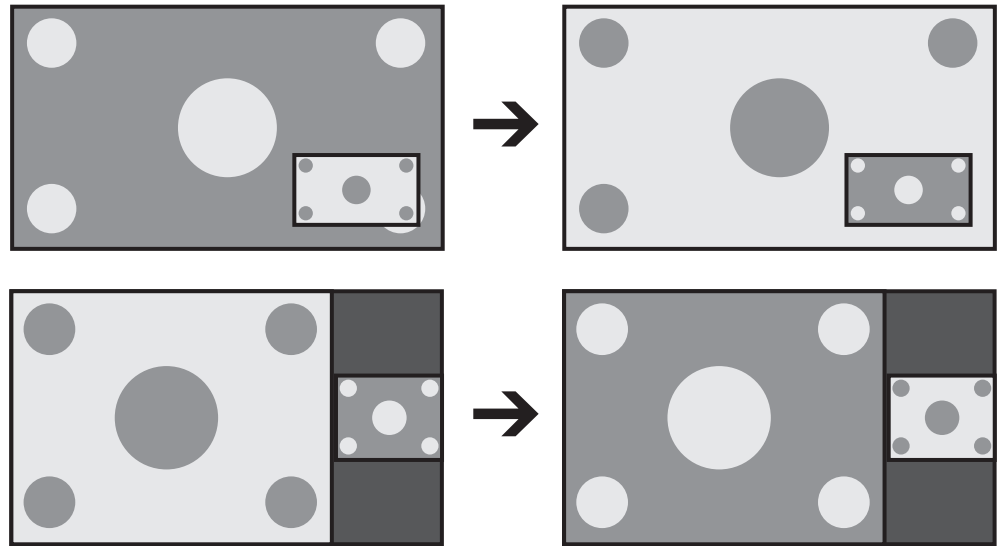
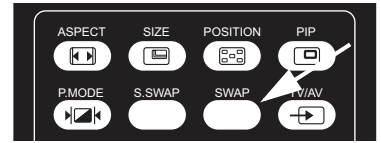

**Swapping the Main and PIP Audio Programs**

➤ To swap the main and PIP audio programs, press the **S.SWAP** button on the remote control.

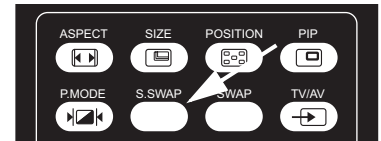



The Crystal Series LCD Display supports Multichannel Television Sound (MTS), the broadcast audio standard that allows transmission of both stereo and Secondary Audio Program (SAP) content.

The SAP is usually a foreign-language translation. However, it can also be used for other purposes such as Described Video Services (DVS), which provide descriptive narration of key visual elements in programs for the benefit of the visually impaired.

You can select sound options (Mono, Stereo, SAP or Mono+SAP) depending on the broadcast signal by pressing the **MTS/SAP** button on the remote control.

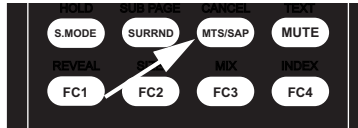

- Choose Stereo for channels that are broadcasting in stereo.
- Choose Mono for channels that are broadcasting in mono, or if you are having difficulty receiving a stereo signal.
- Choose SAP to listen to the Secondary Audio Program.
- Choose **Mono+SAP** to listen to both the primary and secondary audio programs (for example, when a program has a DVS audio track).

Table 4-4 summarizes the audio broadcast modes supported by the Crystal Series LCD Display.

**Table 4-4. Compatibility with Stereo and SAP Audio Broadcasts**

Broadcast Mode	Receive Mode			
	Mono	Stereo	SAP	Mono+SAP
<b>Mono</b>	Mono	Mono	Mono	Mono
<b>Stereo</b>	Mono	Stereo	Mono	Stereo
<b>Mono+SAP</b>	Mono	Mono	SAP	Mono+SAP
<b>Stereo+SAP</b>	Mono	Stereo	SAP	Mono+SAP

## 4.6 Stereo Sound/SAP

**Notes:**

# 5. Maintenance and Troubleshooting

Regular cleaning will extend the life and performance of the Crystal Series LCD Display. Before cleaning, be sure to unplug the power cord from the power outlet.

Do not under any circumstances use solvents such as benzene or thinner to clean the Crystal Series LCD Display. Doing so may cause deterioration or peeling of paint from the display or remote control unit.

Wipe the display and remote control gently with a soft cloth. In case of excessive dirt buildup, dampen a soft cloth with a diluted neutral cleaning detergent. Wring the cloth thoroughly, then wipe the component and dry it with a dry soft cloth.

After dusting, wipe the screen gently using a soft cloth (cotton, flannel etc.). Do not use tissue or coarse fabric. The screen surface is easily scratched; do not rub it or hit it with a hard object.

If you clean the surface of the screen with a wet cloth, do not allow water droplets on the surface to enter into the product; this may cause a malfunction.

As a general rule, use a vacuum cleaner about once a month to clean the vents on the rear panel of the display of dust buildup (set the vacuum cleaner to its weakest setting when doing this). If not removed, accumulated dust can cause the internal temperature to increase, resulting in possible breakdown or fire.

Table 5-1 provides some general guidelines for troubleshooting problems you may encounter with the Crystal Series LCD Display. If you encounter an issue not described here, please contact your Runco dealer or Runco Technical Support.

**Table 5-1. Troubleshooting Chart**

Symptom	Possible Cause(s)	Solution
The display does not turn on after initial installation.	<ul style="list-style-type: none"> <li>The Crystal Series LCD Display is not plugged in or the AC outlet is not active.</li> <li>The remote control batteries have run out.</li> </ul>	<ul style="list-style-type: none"> <li>Ensure that the Crystal Series LCD Display is plugged in and that the AC outlet is active.</li> <li>Replace the batteries.</li> </ul>
The display is on, but there is no picture or sound.	<ul style="list-style-type: none"> <li>Incorrect source selection.</li> <li>Source component is not turned on.</li> <li>Source component is connected incorrectly or not at all.</li> </ul>	<ul style="list-style-type: none"> <li>Select the correct source.</li> <li>Turn on the source component.</li> <li>Check video and/or audio connections to source component.</li> </ul>
Picture is okay, but there is no sound.	<ul style="list-style-type: none"> <li>Audio output is muted.</li> <li>Volume setting is too low.</li> </ul>	<ul style="list-style-type: none"> <li>Press the <b>MUTE</b> button on the remote control.</li> <li>Turn up the volume.</li> </ul>

## 5.1 Cleaning

### ◀ Cleaning the Display Panel Body and Remote Control

### ◀ Cleaning the Screen

### ◀ Cleaning the Vents

## 5.2 Troubleshooting Tips

**Table 5-1. Troubleshooting Chart (continued)**

Symptom	Possible Cause(s)	Solution
Image is too bright and/or lacks definition in the bright areas of the image.	<ul style="list-style-type: none"> <li>Contrast is set too high.</li> </ul>	<ul style="list-style-type: none"> <li>Lower the contrast setting.</li> </ul>
Image appears “washed out” and/or dark areas appear too bright.	<ul style="list-style-type: none"> <li>Brightness is set too high.</li> </ul>	<ul style="list-style-type: none"> <li>Lower the brightness setting.</li> </ul>
Black or white dots appear on all channels or a specific channel.	<ul style="list-style-type: none"> <li>Antenna or cable TV source is connected incorrectly or not at all.</li> <li>Broadcast signal is weak.</li> </ul>	<ul style="list-style-type: none"> <li>Check the antenna or cable TV connection.</li> <li>If using an off-air antenna, adjust its position or location.</li> </ul>
Colors in the image are swapped; for example, reds appear blue or vice versa.	<ul style="list-style-type: none"> <li>The Red/Pr, Green/Y or Blue/Pb outputs from the source are connected to the wrong inputs on the Crystal Series LCD Display.</li> </ul>	<ul style="list-style-type: none"> <li>Ensure that the source outputs are connected to the correct Crystal Series LCD Display input.</li> </ul>
RGB images appear “noisy.”	<ul style="list-style-type: none"> <li>Clock and Phase settings need adjustment.</li> </ul>	<ul style="list-style-type: none"> <li>Manually adjust Clock and Phase settings, or perform an Auto-Adjust (refer to <b>PC Mode Adjust</b> on page 35).</li> </ul>
“Out of range” appears on-screen.	<ul style="list-style-type: none"> <li>The resolution and frequency of the video card in the computer are not compatible with the Crystal Series LCD Display.</li> </ul>	<ul style="list-style-type: none"> <li>Select a compatible resolution and vertical frequency (refer to <b>Computer/Video Signal Compatibility</b> on page 56).</li> </ul>
The image is too large or too small.	<ul style="list-style-type: none"> <li>Image size needs adjusting.</li> </ul>	<ul style="list-style-type: none"> <li>Adjust the image size (refer to <b>PC Mode Adjust</b> on page 35).</li> </ul>
Poor broadcast sound quality.	<ul style="list-style-type: none"> <li>The sound quality of a stereo broadcast may be unstable in an area with a weak signal.</li> </ul>	<ul style="list-style-type: none"> <li>Use the <b>MTS/SAP</b> button on the remote control to select mono.</li> </ul>

# 6. Serial Communications

To interface the Crystal Series LCD Display with a home theater automation/control system or a PC running terminal emulation software, connect it to your control system or PC as shown in Figure 3-8.

Configure the RS-232 controller or PC serial port as follows: no parity, 8 data bits, 1 stop bit and no flow control. Set the baud rate to match that of the Crystal Series LCD Display RS-232 port; the default baud rate is 115200.

Table 6-1 lists the RS-232 command set. All commands are in ASCII format. A carriage return is not required after a command.

When you send a valid command, the Crystal Series LCD Display executes it and acknowledges it with a right-bracket character (]) followed by the four-digit numeric code you sent; for example, ] 0002. When you send an invalid command, the Crystal Series LCD Display ignores it and returns -N/A instead of the four-digit code.

**Table 6-1. Serial Commands**

Command			Description
[	S3A	0###	Set audio volume to ### (=000-100)
<i>Example:</i> [S3A0075 sets volume to 75			
[	+3A		Audio volume up
[	-3A		Audio volume down
[	S4A	000#	Main input selection 0=TV 1=Input1 2=Input2 3=Input3 5=DVI 6=RGB
<i>Example:</i> [S4A0006 selects RGB			
[	S4E	000#	Aspect ratio selection 0=Standard (4x3) 1=VirtualWide 2=Letterbox 3=Anamorphic
<i>Example:</i> [S4E0002 selects Letterbox			
[	S4F	0101	Select Composite Video for Input1
		0102	Select S-Video for Input1
		0201	Select Composite Video for Input2
		0202	Select S-Video for Input2

## 6.1 RS-232 Connection and Port Configuration

## 6.2 Serial Command Syntax

**Table 6-1. Serial Commands (continued)**

Command			Description
		0301	Select Composite Video for Input3
		0303	Select Component Video for Input3
<i>Example:</i> [S4F0101 selects Composite video for Input1			
[	S4G	000#	PIP Input selection 0=TV 1=Input1 2=Input2 3=Input3 5=DVI 6=RGB
<i>Example:</i> [S4G0003 selects Input3			
[	SAB	000#	Power on/off control 0=standby, 1=on
<i>Example:</i> [SAB0001 turns unit on			
[	SBA	000#	Picture mode selection 0=Custom 1=ISF Night 2=ISF Day
<i>Example:</i> [SBA0001 selects ISF Night			
[	SCA	000#	Caption on/off 0=off 1=on
<i>Example:</i> [SCA0000 turns caption off			
[	+CB		TV channel up
[	-CB		TV channel down
[	SCC	000#	Favorite channel selection 1=FC1 2=FC2 3=FC3 4=FC4
<i>Example:</i> [SCC0002 selects favorite channel 2			
[	SDA	000#	Set PIP mode 0=OFF 1=PIP 2=PBP
<i>Example:</i> [SDA0002 selects PBP			
[	SDB	000#	Set PIP size 0=small 1=medium 2=large
<i>Example:</i> [SDB0001 selects medium PIP size			

**Table 6-1. Serial Commands (continued)**

Command		Description	
<p>The following serial commands are meant to emulate buttons on the remote control. Each button has its own serial command, so effectively it is as if you were using the IR remote only you'll be doing so via serial commands. These commands provide active OSD responses just like the IR remote.</p> <p>Each command begins with [key followed by the four-digit number of the button. No carriage return is necessary. The response you receive from the unit if the command is valid will be a right-bracket ( ] ) followed by the four-digit numeric code you sent. (For example, the 'ON' command is [key0015; the response will be ] 0015). All commands are in ASCII.</p>			
[	key	0002	OFF
		0015	ON
[	key	0004	Number 1
		0005	Number 2
		0006	Number 3
		0008	Number 4
		0009	Number 5
		0010	Number 6
		0012	Number 7
		0013	Number 8
		0014	Number 9
		0017	Number 0
		0035	Number 100
		0023	Number "-"
[	key	0001	TIMER OFF
[	key	0105	INPUT1
		0027	INPUT2
		0028	INPUT3
		0102	DVI
		0101	RGB HD
		0019	TV
[	key	0003	CUSTOM
		0062	ISF NIGHT
		0031	ISF DAY
[	key	0040	ANAMORPHIC

**Table 6-1. Serial Commands (continued)**

Command		Description	
		0043	4X3
		0039	LETTERBOX
		0126	VIRTUALWIDE
[	key	0007	Right-Arrow key
		0016	Down-Arrow key
		0018	Up-Arrow key
		0011	Left-Arrow key
		0046	ENTER
[	key	0026	MENU
[	key	0100	EXIT
[	key	0063	PIP ASPECT RATIO
		0047	PIP SIZE
		0034	PIP POSITION
		0032	PIP
		0037	P.MODE
		0052	S.SWAP
		0033	SWAP
		0036	TV/AV
[	key	0053	S.MODE
		0054	SURROUND
		0024	MTS/SAP
		0091	MUTE
[	key	0057	FAVORITE CHANNEL 1
		0045	FAVORITE CHANNEL 2
		0044	FAVORITE CHANNEL 3
		0055	FAVORITE CHANNEL 4



# 7. Specifications

Table 7-1 lists the Crystal Series LCD Display specifications.

**Table 7-1. Crystal Series LCD Display Specifications**

<b>Native Resolution:</b>	1366 x 768 WXGA
<b>Screen Size:</b>	<b>CR-26HD</b> = 26 in. (diagonal) <b>CR-32HDi</b> = 32 in. (diagonal)
<b>Screen Aspect Ratio:</b>	16:9
<b>Available Aspect Ratios:</b>	4:3, Letterbox, 16:9 Anamorphic, VirtualWide™
<b>DTV Compatibility:</b>	480i/p, 576i/p, 720p, 1080i
<b>ISF Settings:</b>	Yes
<b>Contrast Ratio:</b>	1000:1
<b>Data/Graphics Compatibility:</b>	Up to 1024 x 768
<b>Imagix Processing:</b>	3:2 pull down
<b>Inputs:</b>	Multiple input combinations with up to (3) Composite, (2) S-Video, (1) Component, (1) DVI w/HDCP, (1) RGB (15-pin D-sub), (1) RS-232, (4) Audio (stereo RCA pairs), (1) RF Antenna
<b>Outputs:</b>	(1) Composite, (2) Audio (stereo RCA pair, 3.5-mm stereo mini jack for headphones)
<b>Audio System:</b>	10W RMS x 2, L/R two-way Integrated Speaker System
<b>Tuner:</b>	NTSC/ATSC Stereo (PAL as monitor only), HDTV Ready, PIP/PBP, Parental Control (V-Chip), Closed Caption
<b>Discrete IR Control:</b>	Source, power and aspect ratios
<b>Power Requirements:</b>	100 to 240 VAC, 50/60Hz
<b>Power Consumption:</b>	<b>CR-26HD</b> = 130W (443.7 BTUs/hour) <b>CR-32HDi</b> = 180W (614.3 BTUs/hour)
<b>Operating Environment:</b>	40°F to 95°F (5°C to 35°C); 20% to 80% humidity (non-condensing)
<b>Dimensions:</b>	<b>CR-26HD</b> = see Figure 7-1 <b>CR-32HDi</b> = see Figure 7-2
<b>Weight:</b>	<b>CR-26HD</b> = 26.46 lbs. (12 kg) <b>CR-32HDi</b> = 50.71 lbs. (23 kg)
<b>Regulatory Approvals:</b>	Complies with FCC, UL
<b>Limited Warranty:</b>	One (1) year parts and labor from the date of delivery to the end user.

## 7.1

### Crystal Series LCD Display Specifications

Specifications are subject to change without notice.

## 7.2 Crystal Series LCD Display Dimensions

Figure 7-1 and Figure 7-2 show the Crystal Series LCD Display dimensions.

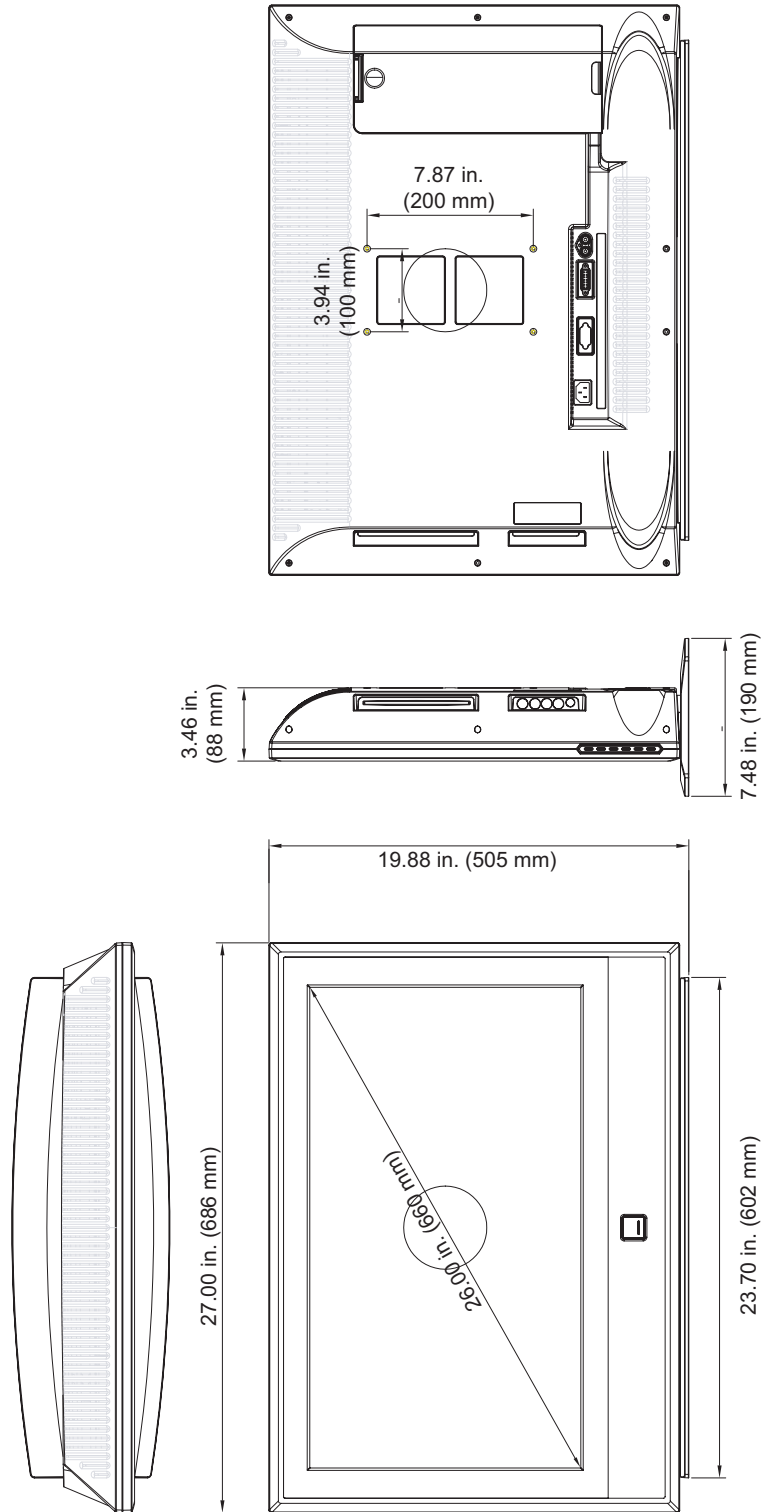
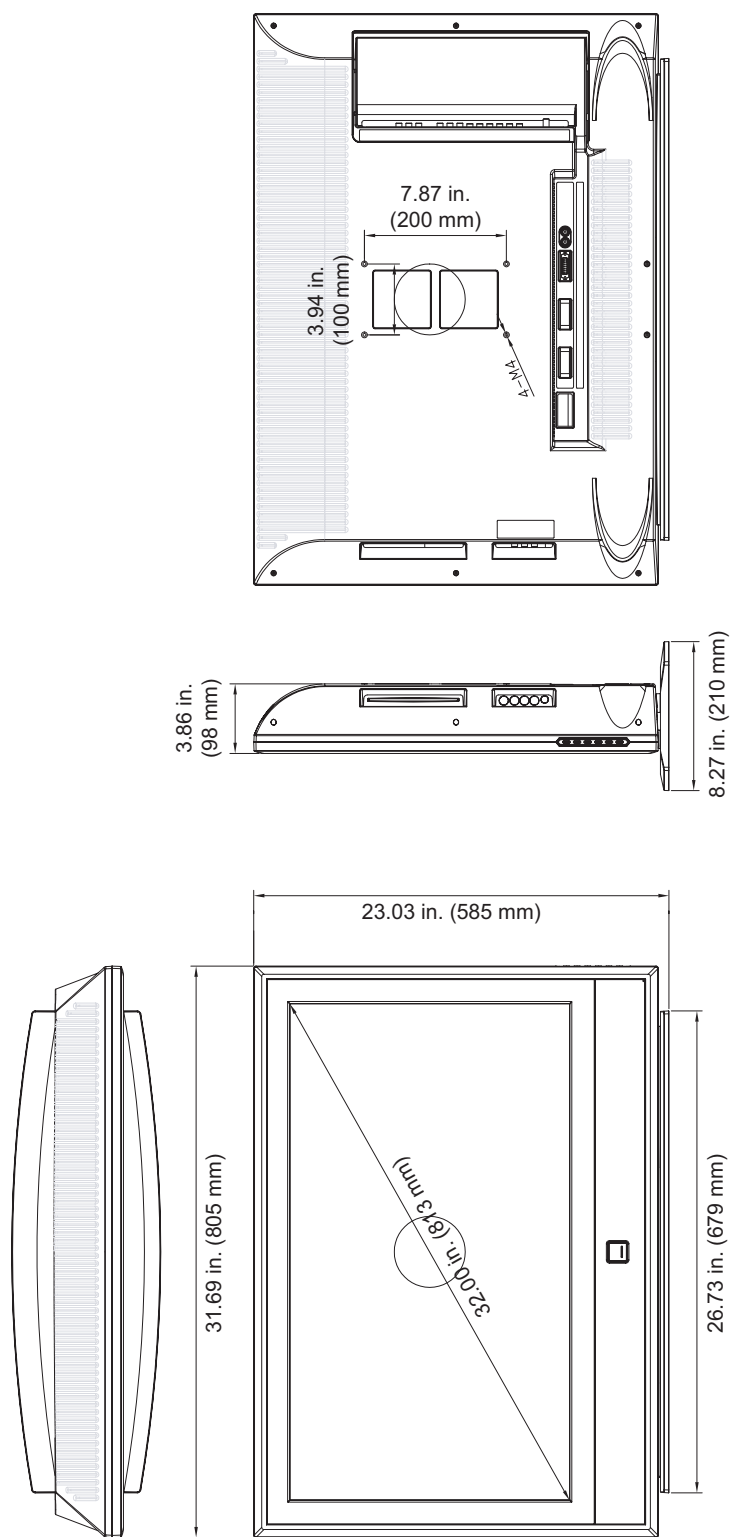

Figure 7-1. CR-26HD Dimensions



**Figure 7-2. CR-32HDi Dimensions**

### 7.3 Computer/Video Signal Compatibility

The Crystal Series LCD Display can display video signals from a variety of computer sources via its RGB and DVI inputs.

Table 7-2 lists the signal types that are compatible with the Crystal Series LCD Display, and indicates which of those are VESA standards.

**Table 7-2. Computer/Video Signal Compatibility Chart**

Signal Type	Mode		Vertical Frequency (Hz)	Horizontal Frequency (kHz)
SD	720x240	60i	59.94	15.75
SD	720x480	60p	59.94	31.50
HD	1280x720	60p	60.00	44.90
HD	1920x1080	60i	60.00	33.70
VESA	720x400	85	85.00	37.90
VESA	720x350	85	85.00	37.90
IBM	720x400	70	70.10	31.50
IBM	720x350	70	70.10	31.50
VESA	720x480	60	59.94	31.50
MAC	720x480	67	66.70	35.00
VESA	720x480	72	72.80	37.80
VESA	720x480	75	75.00	37.50
VESA	720x480	85	85.00	43.60
VESA	800x600	56	56.25	35.20
VESA	800x600	60	60.30	37.90
VESA	800x600	72	72.20	48.70
VESA	800x600	75	75.00	46.90
VESA	800x600	85	85.10	53.70
MAC	832x624	75	74.50	49.70
VESA	1024x768	60	60.00	48.40
MAC	1024x768	60	60.00	48.70
VESA	1024x768	70	70.10	56.50
IBM	1024x768	72	72.10	57.50
VESA	1024x768	75	75.00	60.00
MAC	1024x768	75	75.00	60.00
VESA	1024x768	85	85.00	68.70

*Note: The Crystal Series LCD Display may not be able to display images from notebook computers in simultaneous (CRT/LCD) mode. Should this occur, switch the notebook computer to "CRT only" mode. If you are unsure how to do this, refer to your notebook computer's user manual.*





SERIAL NUMBER  
RUMA-011090  
rev 10-22-07 v2.6