

OKI C9000 Series



Setup Guide

Preface

Every effort has been made to ensure that the information in this document is complete, accurate, and up-to-date. Oki assumes no responsibility for the results of errors beyond its control. Oki also cannot guarantee that changes in software and equipment made by other manufacturers and referred to in this guide will not affect the applicability of the information in it. Mention of software products manufactured by other companies does not necessarily constitute endorsement by Oki.

While all reasonable efforts have been made to make this document as accurate and helpful as possible, we make no warranty of any kind, expressed or implied, as to the accuracy or completeness of the information contained herein.

Copyright 2000 by Oki. All rights reserved.

Oki is a registered trademark of Oki Electric Industry Company Ltd.

Energy Star is a trademark of the United States Environmental Protection Agency.

Microsoft, MS- DOS and Windows are registered trademarks of Microsoft Corporation.

CAUTION:

This product complies with EN55022 Class B however, when fitted with either the optional 2nd and/or high capacity feeder compliance to EN55022 is Class A. In a domestic environment this product configuration may cause radio interference in which case the user may be required to take adequate measures.

EEC compatibility



This product complies with the requirements of the Council Directives 89/336/EEC (EMC) and 73/23/EEC (LVD), as amended where applicable, on the approximation of the laws of the member states relating to Electromagnetic Compatibility and Low Voltage.

Energy Star



As an Energy Star Partner, Oki has determined that this product meets the Energy Star guidelines for energy efficiency.

Table of contents

Preface	ii	Chapter 2 - Windows Setup	13
EEC compatibility.	ii	Installation method.	13
Energy Star	ii	Printer driver types.	13
Table of contents.	iii	Parallel interface	14
Safety instructions.	v	Connection	14
Toner cartridge and image drum handling	vi	Plug and play configuration	14
Emergency first aid	vii	Windows 2000	14
Notes, cautions and warnings	vii	Windows 98 or Windows Me	16
Chapter 1 - Printer Setup	1	Add printer configuration.	18
Features.	1	Windows 2000	18
Unpacking	2	Windows 98 or Windows Me	20
Printer components	3	Windows 95	22
Control panel.	5	Windows NT 4.0.	24
Printer location	6	USB interface.	27
Setting up	6	General	27
Packaging and protective sheet removal.	6	Connection	27
Toner cartridge installation	8	USB driver	28
Loading paper	9	Plug and play configuration	29
Power cable.	10	Windows 2000	29
Switching off.	11	Windows 98 or Windows Me	30
Menu settings	11	Add printer configuration.	32
Changing display language	11	Windows 2000	32
Printing	12	Windows 98	34
		Network connection.	37

Internal hard disk	37	Macintosh USB connection	49
Printer	37	Macintosh network connection	49
Printer driver	38	Duplex unit	49
Windows 2000/NT 4.0 PostScript	38	Printer	49
Windows 2000 PCL	38	Printer driver	49
Windows 98/95 PostScript	39	Macintosh USB connection	49
Windows 98/95/NT 4.0 PCL	39	Macintosh network connection	50
Duplex unit	40	Index	51
Printer	40		
Printer driver	40		
Windows 2000/NT 4.0 PostScript	40		
Windows 2000 PCL	40		
Windows 98/95 PostScript	41		
Windows 98/95/NT 4.0 PCL	41		
Chapter 3 - Macintosh Setup	43		
USB connection	43		
Operating environment	43		
Connection	43		
Printer driver installation	44		
Creating desktop printer	45		
Network connection	47		
Operating environment	47		
Connection	47		
Printer driver installation	47		
Internal hard disk	48		
Printer	48		
Printer driver	49		

Safety instructions

This printer has been carefully designed to give years of safe, reliable performance. As with all electrical equipment, however, there are a few basic precautions that should be taken to avoid personal injury or damaging the printer:

- Read this setup guide carefully and save it for future reference.
- Read and follow all warning and instruction labels on the printer itself.
- Disconnect the printer before cleaning. Use only a damp cloth. Do not use liquid or aerosol cleaners to clean the printer.
- Place the printer on a firm, solid surface. If the printer is placed on something unsteady, it may fall and become damaged or injure someone. If the printer is placed on a soft surface, such as a rug, sofa, or bed, the vents may become blocked causing the printer to overheat.
- Do not put the printer on or near a heat source, such as a radiator or heat register. Keep it out of direct sunlight. Allow enough room around the printer for adequate ventilation and easy access.
- Do not use the printer near water, or spill liquid of any kind into it.
- Make sure that the power source matches the rating listed on the back of the printer. If you are not sure, check with your dealer or with your local power company.
- This printer has an earthed, 3-pin plug as a safety feature and will only connect to an earthed outlet. If this plug cannot be connected to a power outlet, then it is possible that the power outlet is of the older, non-earthed type. Contact an electrician to have the power outlet replaced. Do not use an adapter to defeat the earthing.
- To avoid damaging the power cable, do not put anything on it or place it where it will be walked on. If the cable becomes damaged or frayed, replace it immediately.
- If an extension cable or power strip is being used with the printer, make sure that the total of the amperage rating required by all the equipment is less than the rating of the extension cable or power strip. The total ratings of all equipment plugged into the outlet should not exceed 13 amperes.

- The power outlet into which the printer is connected must remain accessible at all times.
- Opening any cover may expose hot surfaces. These are clearly labelled. Do NOT touch them.
- Do not insert anything into the ventilation slots on the printer; you could get a shock or cause a fire.
- Aside from the routine maintenance described in this user's guide, do not try to service the printer yourself. Opening a cover may expose you to shocks or other hazards.
- Do not make any adjustments other than those outlined in this users guide as damaged may be caused to the printer.

If anything happens that indicates that the printer is not working properly or has been damaged, disconnect the printer from the power source and contact your dealer. These are some of the things to look for:

- The power cable or plug is frayed or damaged.
- Liquid has been spilled into the printer, or it has been exposed to water.
- The printer has been dropped, or the cabinet is damaged.

- The printer does not function normally when following the operating instructions.

Toner cartridge and image drum handling

- Leave unused toner cartridges and image drum units in their packages until needed. When replacing a toner cartridge or image unit, reuse the packaging to dispose of the old toner cartridge or image drum unit.
- Do not expose the toner cartridges and image drum units to light for more than five minutes. Never expose the green drum (inside the image drum unit) to direct sunlight.
- Always hold the image drum unit by the ends - never by the middle. Never touch the green drum inside the image drum unit.
- To avoid damage to the image drum unit, always use original toner cartridges.
- Exercise care when removing the toner cartridge. Do not let it touch your clothing or porous materials. The toner powder causes permanent stains.

- Small amounts of toner spilled on skin or clothing can be readily removed with soap and cold water. Using heated water will make removing the stain much more difficult.

Emergency first aid

- **IF TONER IS SWALLOWED:** Induce vomiting and seek medical attention. Never attempt to induce vomiting or give anything by mouth to a person who is unconscious.
- **IF TONER IS INHALED:** Take the person to an open area for fresh air. Seek medical attention.
- **IF TONER GETS IN THE EYES:** Flush eyes with large quantities of cool, NOT cold, water for a minimum of 15 minutes keeping eyelids open with fingers. Seek medical attention.

Notes, cautions and warnings

***Note:** A note appears in this manual like this. A note provides additional information to supplement the main text which may help you to use and understand the product.*

CAUTION:

A caution appears in this manual like this. A caution provides additional information which, if ignored, may result in equipment malfunction or damage.

WARNING

A WARNING APPEARS IN THIS MANUAL LIKE THIS. A WARNING PROVIDES ADDITIONAL INFORMATION WHICH, IF IGNORED, MAY RESULT IN A RISK OF PERSONAL INJURY.

Chapter 1 - Printer Setup

Features

- High speed printing: 21 page per minute LED colour printer and 26 page per minute LED monochrome printer with single pass digital technology for stunning quality, speed and reliability.
- Four different models to choose from: C9200, C9200n, C9200dn and the flagship C9400.
- True 1200 dpi resolution (C9400) or 600 x 1200 dpi resolution for very high quality output.
- Duplex printing for fast reliable two sided output (optional on C9200 and C9200n).
- High speed, bi-directional parallel interface (IEEE-1284) and USB interface
- Industry standard network connectivity via internal network interface card (optional on C9200)
- Automatic interface switching between USB, parallel and network interfaces.
- Spacious 5 Gb hard disc drive (HDD) standard on C9200dn and C9400, optional on other models.
- PCL5c emulation and genuine Adobe PostScript 3 with automatic switching.
- Versatile paper handling with standard 550 sheet paper tray and 100 sheet multi purpose tray
- Optional 2nd and 3rd paper trays each with a capacity of 550 sheets approx and an optional high capacity feeder that can provided a feed of 1650 sheets of plain paper giving a maximum capacity of 2850 sheets.
- Paper weight capacity of 75 gm² to 200 gm².
- 500 sheet output tray (face down) and 100 sheet face up tray for continuous smooth running output.
- The C9000 series is designed for a maximum duty cycle of up to 83 000 prints per month.
- Environmentally friendly: OKI's advanced power save mode minimises power consumption and the separate toner and drum design cuts down on waste.

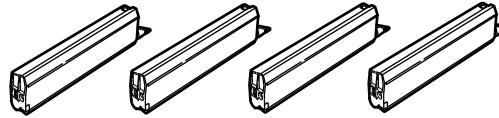
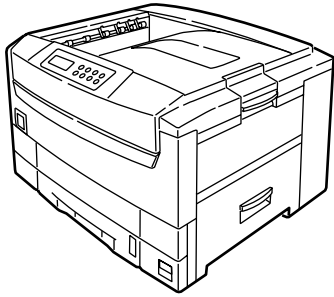

Unpacking

After unpacking the printer and choosing a suitable place to put it, check that all the necessary parts are available to continue:

WARNING

THIS PRINTER HAS A WEIGHT OF 72 kg. DO NOT ATTEMPT TO LIFT IT ALONE.

1. The printer.
2. Four toner cartridges (cyan, magenta, yellow and black).
3. CD-ROM disk containing printer drivers and documentation (not illustrated).

4. Paper size indicator (not illustrated).
5. LED lens cleaner (not illustrated).
6. Lightproof plastic bags (4) (not illustrated).
7. Power cable (not illustrated).
8. Setup guide (not illustrated).

Note: *Do not discard the printer box, transport locks, packaging and lightproof plastic bags as they are used when transporting the printer.*

Printer components

1. Top cover
2. Top cover release catch.
3. Multi purpose tray (manual feed).
4. Paper support extension.
5. Side cover.
6. Paper guides.
7. Paper level indicator.
8. Paper tray.
9. Power switch.

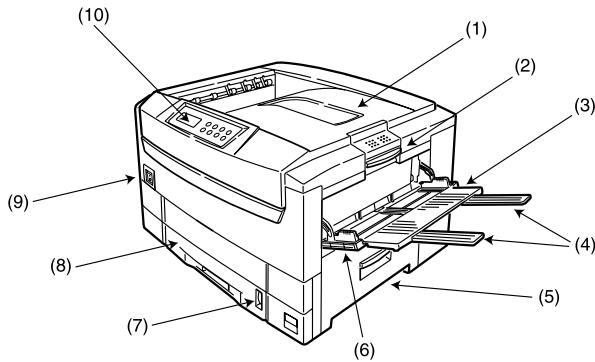

10. Control panel.
11. LED heads (4of).
12. Discharge roller.
13. Fuser unit.
14. Image drum (cyan).
15. Image drum (magenta).
16. Image drum (yellow).
17. Image drum (black).

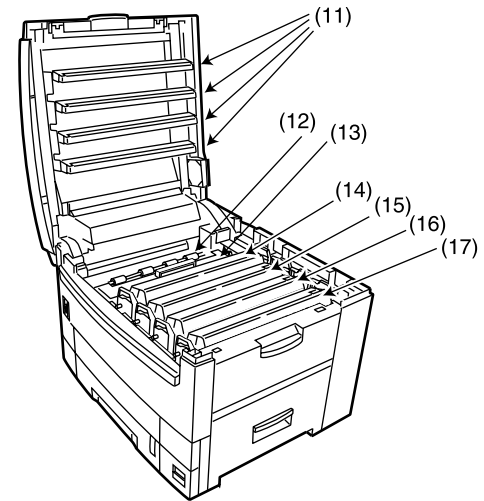

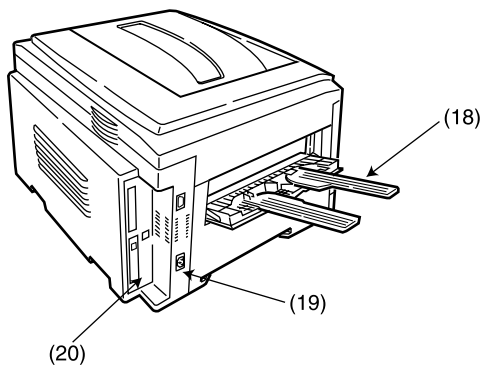

- 18. Rear exit paper tray.
- 19. Power connector.
- 20. Interfaces and option card slot.

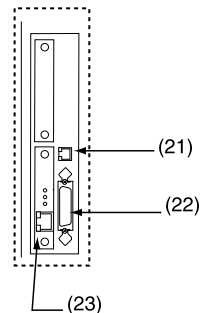

- 21. USB interface connector.
- 22. Parallel interface connector.
- 23. Optional network interface card.

Control panel

1. Attention indicator (red). On indicates there is an error, but printing will continue. Flashing indicates there is an error, but printing will stop.
2. Ready indicator (green). On - ready to receive data. Flashing - processing data or error.
3. Liquid crystal display (LCD) panel. Two rows of up to 24 alphanumeric digits displaying print status, menu items in menu mode and error messages.
4. Menu button (0). Press briefly to enter Menu mode. Press briefly again to select the next menu. Press for more than 2 seconds to scroll through the different menus.

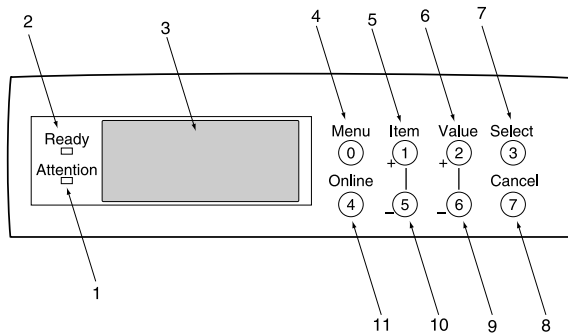

5. Item + button (1). Press briefly to scroll forward to the next menu item.
6. Value + button (2). Press briefly to scroll forward to the next value setting for each menu item.
7. Select button (3). Press briefly to select the menu, item or value indicated on the LCD.
8. Cancel button (7). Press to cancel a print job.
9. Value – button (6). Press briefly to scroll backward to the next value setting for each menu item.
10. Item – button (5). Press briefly to scroll backward to the next menu item.
11. Online button (4). Switches between online and offline status. When pressed in Menu mode, returns printer to online status. When pressed with DATA PRESENT displayed forces the printer to print out the remaining data in the printer. Also when there is an error indicating wrong paper size, pressing the online button forces the printer to print.

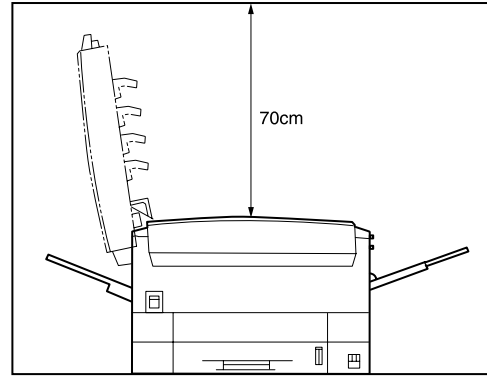
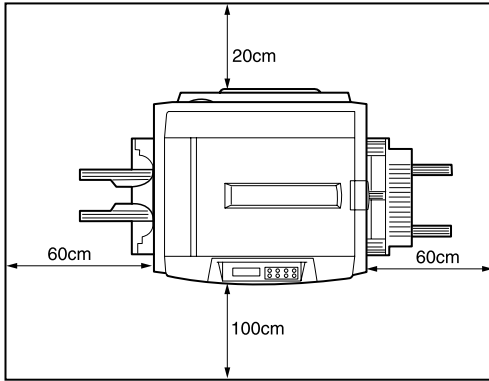

Printer location

Place the printer on a flat surface large enough and strong enough to accept the size and weight of the printer. The printer has an approximate weight of 72 kg. There must be sufficient space around the printer to allow for access and printer maintenance.

Setting up

Before connecting this printer to a computer and power supply, the toner cartridge must be installed and paper inserted in the paper tray.

Packaging and protective sheet removal

1. Remove any adhesive tape and packaging from the printer.

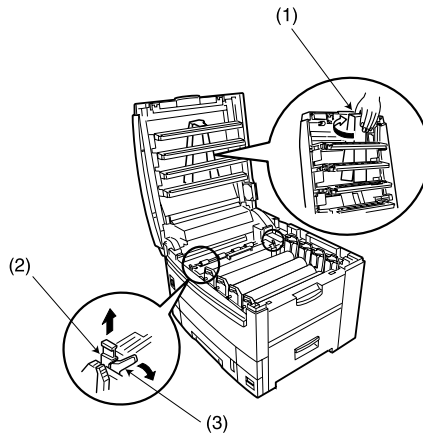

2. Open the top cover.
3. Remove the LED head restrainer (1) from behind the LED heads in the top cover.
4. Remove the orange transport lock (2) from behind the coloured lever (3) on top of the fuser unit.

Note: *To ease removal of the transport lock, it may be necessary to move the coloured lever (3) slightly. The coloured lever will return to its original position under spring loading after it has been released.*

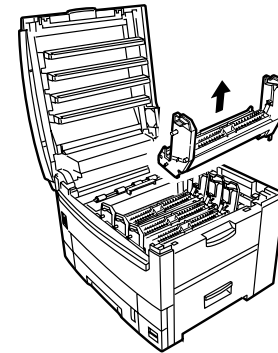

CAUTION:

Never expose image drums to light for more than 5 minutes. Never expose image drums to direct sunlight. Always hold image drums by the ends. Never touch the surface of the green drum inside the image drum.

5. Remove the four image drums and place them on a level surface.
6. Remove the protective sheets (1) from each of the four image drums.
7. Push the tab (2) inwards and remove the blanking plate (3) from each of the image drums.

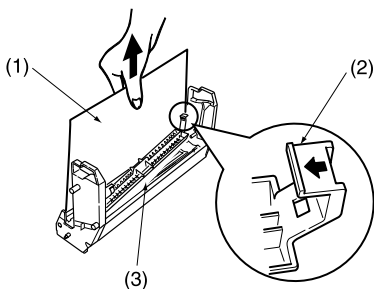

- Replace the four image drums into the printer making sure each image drum is installed in its correct colour location.

WARNING

BE CAREFUL WHEN HANDLING THE TONER CARTRIDGE. DO NOT LET TONER SPILL ON YOUR CLOTHING OR OTHER POROUS MATERIALS.

CAUTION:

Do not use excessive force when installing the toner cartridge.

Toner cartridge installation

- Remove the four colour toner cartridges from their packages.

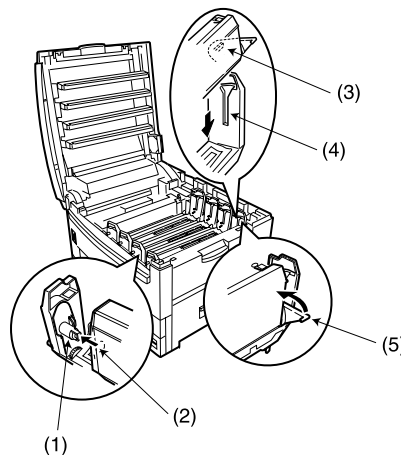
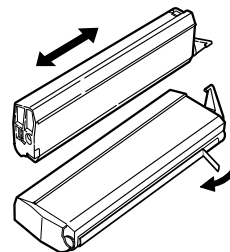

- Shake the toner cartridges back and forth several times.

3. To prevent any accidental spillage of toner, hold the toner cartridge horizontally and remove the tape carefully and slowly.
4. Make sure the colours of the toner cartridge and image drum correspond.
5. Insert the toner cartridge into the image drum, left side first, engaging the drum spigot (1) in the hole (2) in the toner cartridge.
6. Gently push the toner cartridge down engaging the locking pin (3) into the groove (4) on the image drum.
7. Gently push the coloured lever (5) backward until it stops to release the toner into the image drum.

Note: *When the printer is switched on after setting up the printer, the message TONER LOW or CHANGE TONER maybe displayed. This message should disappear after the printer has completed its initialisation sequence. However, this message sometimes does not disappear until printing has been carried out. If it still does not disappear after printing, reinstall the toner cartridge.*

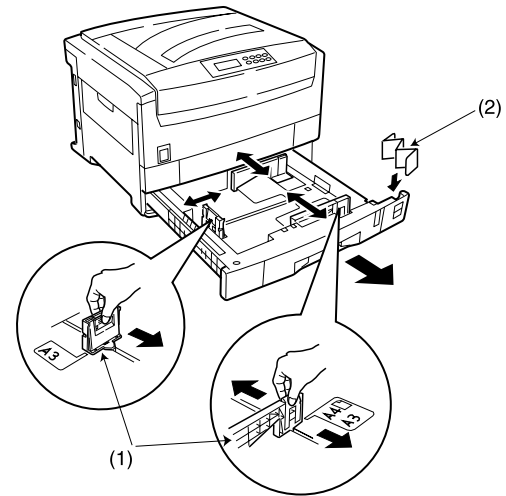

Loading paper

1. Remove the paper tray from the printer.
2. Adjust the paper guides (1) for the size of paper being used.
3. Insert the paper size indicator (2) into the slot on the paper tray.
4. Insert the paper keeping the level of the paper in the tray below the guide marks.

Note: Do not exceed the maximum capacity of the paper tray, which is approximately 550 sheets depending on paper weight.

5. Replace the tray in the printer. The paper level indicator provides a visual indication of how much paper is left in the tray.

Power cable

1. Connect the power cable into the power socket on the printer, then into a grounded power supply outlet.

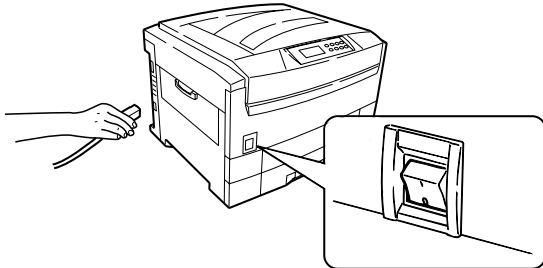

2. Switch the printer on using the main power switch.

3. The printer goes through its initialisation and warm up sequence. When the printer is ready, the READY indicator comes on and stays on (green) and the LCD indicates the following:

ONLINE	AUTO
	TRAY1

Switching off

Note 1: *Never turn the printer off while it is printing.*

Note 2: *If the optional hard disk has been fitted, The following procedure **MUST BE** followed before turning off to protect any data that is stored on the hard disk.*

Note 3: *It is recommended to follow this shutdown procedure each time the printer is switched off for any reason.*

1. Press **Menu (0)** button until the SHUTDOWN MENU is displayed, then press **Select (3)** button.
2. Press **Select (3)** button again to EXECUTE the shutdown sequence.
3. When PLEASE POWER OFF SHUTDOWN COMPLETED is displayed on the LCD, turn the printer off using the power switch.

Menu settings

Changing display language

Carry out the following to change the language that is displayed on the printer's LCD.

1. Press **Menu (0)** button until SYSTEM CONFIG MENU is displayed, then press **Select (3)** button.
2. Press **Item (1)** until LANGUAGE is displayed.
3. Press **Value (2)** until the required language is displayed.
4. Press **Select (3)** button. An asterisk (*) appears next to the selected language.
5. Press **Online (4)** button when finished setting the display language.

Printing

Print a list of menu settings to confirm that the printer is correctly configured.

1. Make sure there is A4 size paper in the paper tray.
2. Press **Menu (0)** button until the INFORMATION MENU is displayed, then press **Select (3)** button.
3. Confirm PRINT MENU MAP is displayed on the LCD.
4. Press **Select (3)** button to print the menu map.

Chapter 2 - Windows Setup

Installation method

The installation of the Windows printer driver and its associated software depends upon the interface connection and the Windows operating system.

Note 1: *Windows NT 4.0 drivers cannot be installed using Windows Plug & Play.*

Note 2: *Please refer to the readme file on the software installation disk that came with the printer for the latest information on the installation of the printer driver and its associated software.*

Printer driver types

This printer can be operated using a PostScript printer driver or a PCL printer driver. Both types of printer drivers have been supplied on the CD-ROM that came with the printer.

Which printer driver is installed does depend on how the printer is to be used. For example, if encapsulated postscript (EPS) files are going to be printed, then it is recommended to use a PostScript printer driver.

Parallel interface

Note 1: *Printer drivers are not supplied for MS-DOS or Windows NT 3.51 operating systems.*

Note 2: *Printer drivers are not provided for Windows NT4.0 operating system installed on a computer with an ARC compatible RISC based processor (MIPS R series, Alpha, Power PC etc.).*

Note 3: *Parallel interface cable is not included. The parallel interface cable must be bi-directional and to standard IEEE 1284-1994.*

Connection

1. Switch off the power to the printer and computer.

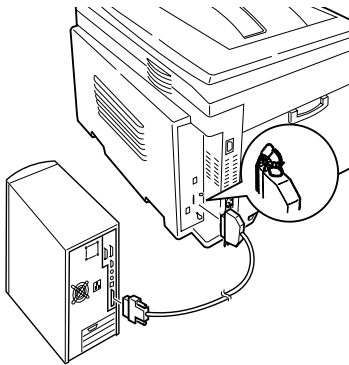

2. Connect the parallel interface cable to the printer parallel interface connector and secure with spring clips.
3. Connect the parallel interface cable to the parallel port on the computer and secure with screws.
4. Switch on the printer and then switch on the computer.

Plug and play configuration

Windows 2000

Note: *Administrator's authority is required when installing under Windows 2000.*



1. When the [Found New Hardware Wizard] appears, click on [Next].

Note: *If the system has already been configured once, the printer driver configures automatically and the Found New Hardware Wizard is not displayed. Please proceed to Step 9.*

2. Select [Search for the best driver for my device (Recommended)] and click on [Next].



3. Choose [Specify a location] and click on [Next].
4. Insert the printer software CD-ROM into the CD-ROM drive.

5. Uncheck [Floppy disk drive] and check [CD-ROM drive], then click on [Next] to install by default the PCL printer driver.

OR

To install another printer driver, uncheck both [Floppy disk drive] and [CD-ROM drive] and check [Specify a location]. Enter D:\DRIVERS\WIN2000\Language (where D:\ is the drive letter of the CD-ROM), then click on [Next] selecting the required printer driver.

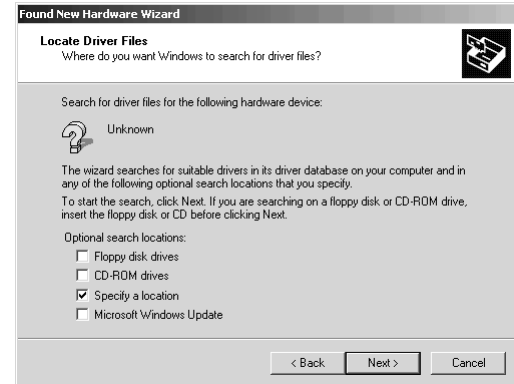

6. Confirm that the printer driver is ready to be installed and click on [Next].

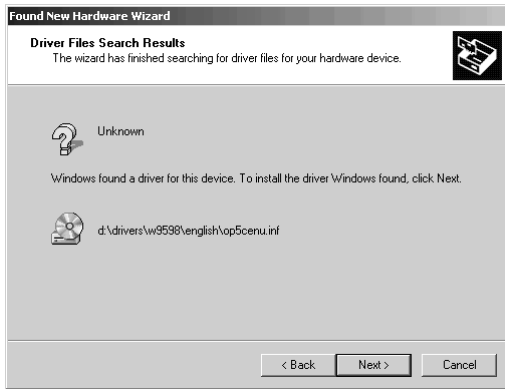

7. Specify if a test page is to be printed or not, then click on [Next] and click on [Finish].
8. In the [Digital Signature Not Found] window, click on [Yes]. File copying starts.



9. Choose [Start]-[Settings]-[Printers], then right click the printer icon and select [Set as Default Printer].

Note: *If the printer icon is not displayed, configure using the **Add Printer Wizard**.*

Windows 98 or Windows Me

1. When the [Add New Hardware Wizard] appears, click on [Next].

Note 1: *If the [Insert Disk] window is displayed, go to Step 8.*

Note 2: *If the [Add New Hardware Wizard] does not appear, go to Add Printer Function.*



- Choose [Search for the best driver for your device (Recommended)] and click on [Next].



- Insert the printer software CD-ROM into the CD-ROM drive.
- Uncheck [Floppy disk drive] and check [CD-ROM drive], then click on [Next] to install by default the PCL printer driver.

OR

For Windows 98 - To install another printer driver, uncheck both [Floppy disk drive] and [CD-ROM drive] and check [Specify a location]. Enter D:\DRIVERS\W9598\Language (where D:\ is the drive letter of the CD-ROM), then click on [Next] selecting the required printer driver.

OR

For Windows ME - Select the required driver from the displayed list in order to install the language required.

- Confirm the printer name and specify if the printer is to be the default printer or not, then click on [Next].

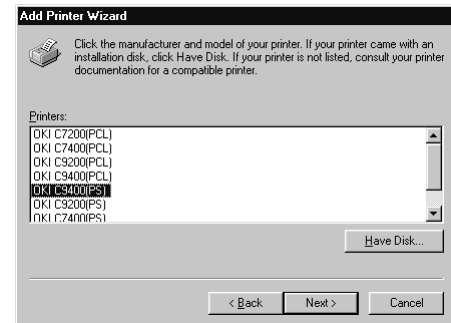

- Specify if a test page is to be printed or not, then click on [Finish].
- When the printer icon appears in the Printer folder, configuration is complete.
- If the [Insert Disk] window is displayed:
 - Insert the printer software CD-ROM into the CD-ROM drive and click on [OK].

- (b) In the [Copy files from] field, enter D:\DRIVERS\W9598\Language for PostScript or PCL drivers (where D:\ is the drive letter of the CD-ROM) and click on [OK]. File copying starts.
- (c) When the printer icon is displayed in the Printer folder, configuration is complete.

Add printer configuration

Windows 2000

Note: Administrator's authority is required when installing under Windows 2000.

1. Click on [Start]-[Settings]-[Printers].
2. Double-click on [Add Printer].



3. When [Add Printer Wizard] appears, click on [Next].
4. Select [Local Printer], remove the check mark on [Automatically detect and install my Plug and Play printer] and click on [Next].

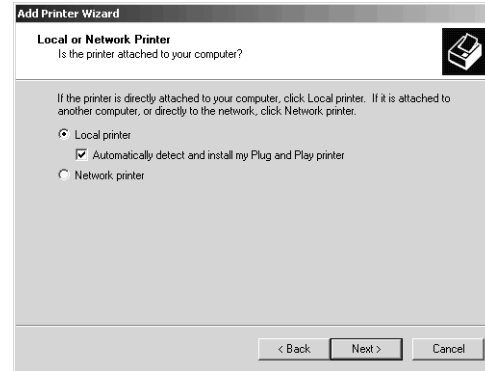

5. Select [Use the following port] and specify [LPT1: Printer Port], then click on [Next].

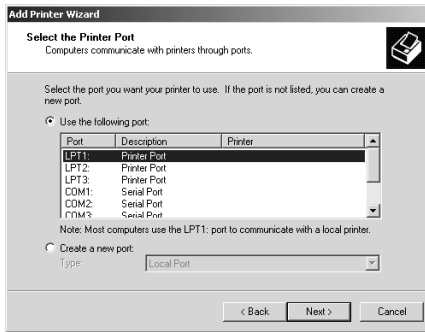

- Click on [Have Disk...].

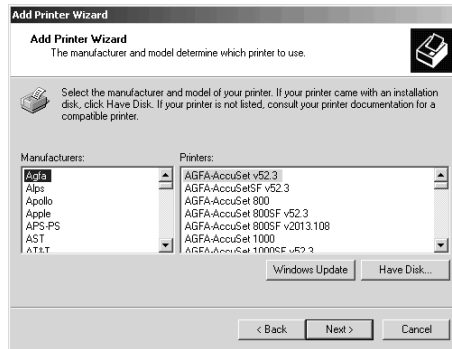

- After the [Install from Disk] window appears, insert the Printer Software CD-ROM disk into the CD-ROM drive.

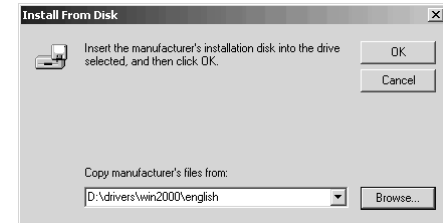

- In the [Copy manufacturer's files from] field, enter D:\DRIVERS\WIN2000\Language for PostScript or PCL drivers (where D: is the drive letter of the CD-ROM) and click on [OK].
- Choose the printer model and driver required and click on [Next].

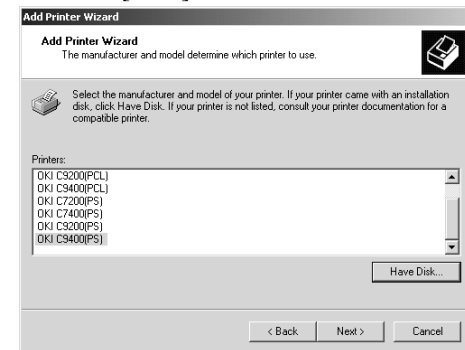

10. Confirm printer name and specify if the printer is to be used as default printer or not, then click on [Next].

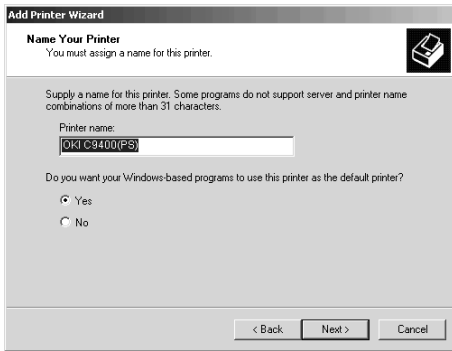

11. Specify if the printer is to be shared or not, then click on [Next].

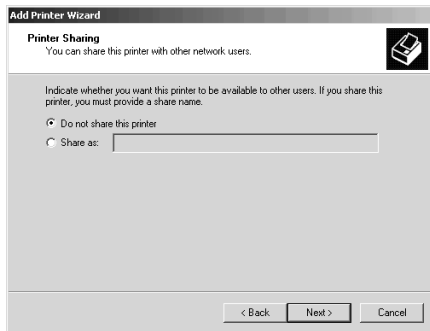

12. Specify if a test page is to be printed or not, then click on [Next] and click on [Finish].
13. In the [Digital Signature Not Found] window, click on [Yes]. File copying starts.

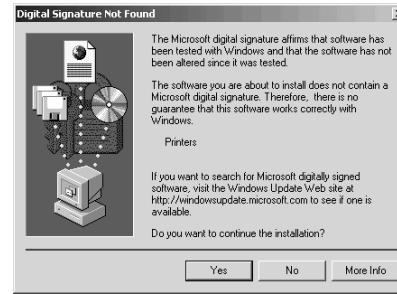

14. When the printer icon is displayed in the Printer folder, configuration is complete.

Windows 98 or Windows Me

1. Click on [Start]-[Settings]-[Printers].
2. Double-click on [Add Printer].
3. When the displayed [Add Printer Wizard], click on [Next].

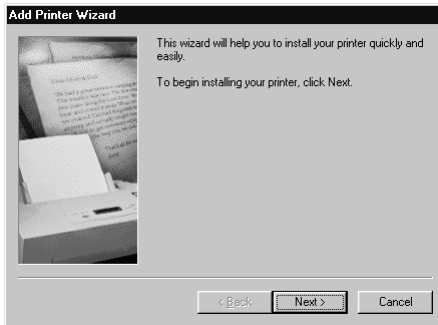

4. Select [Local Printer] and click on [Next].

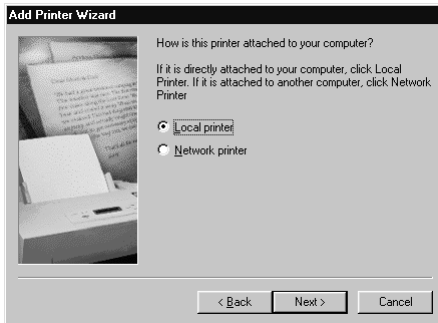

5. Click on [Have Disk...].

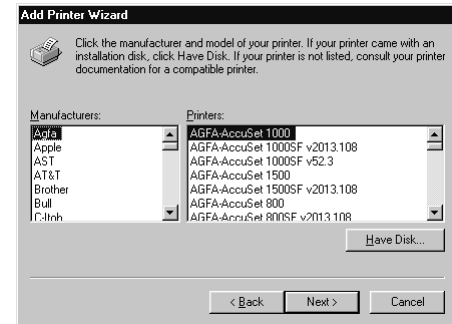

6. After the [Install from Disk] window appears, insert the Printer Software CD-ROM disk into the CD-ROM drive.



7. In the [Copy files from] field, enter D:\DRIVERS\W9598\Language for PostScript or PCL drivers (where D:\ is the drive letter of the CD-ROM) and click on [OK].

8. Choose the printer model and driver required and click on [Next].

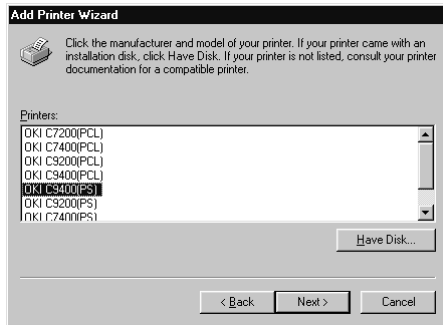

9. Among [Available Ports], select [LPT1:ECP Printer Port] and click on [Next].

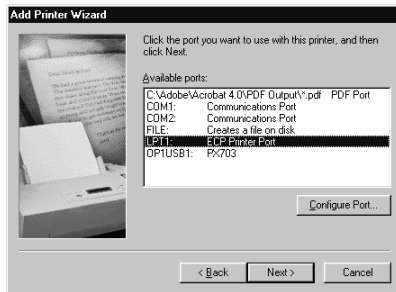

10. Confirm printer name and specify if the printer is to be used as default printer or not, then click on [Next].



11. Specify if a test page is to be printed or not, then click on [Finish].
12. When the printer icon appears in the Printer folder, configuration is complete.

Windows 95

1. Click on [Start]-[Settings]-[Printers].
2. Double-click on [Add Printer].

- When the [Add Printer Wizard] appears, click on [Next].



- Select [Local Printer] and click on [Next].



- Click on [Have Disk...].

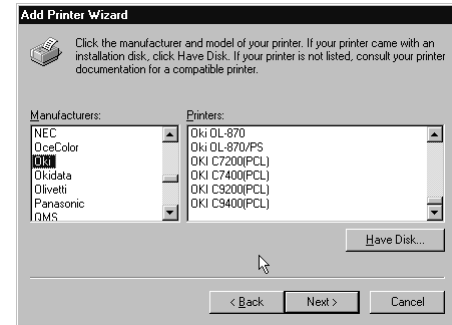

- After the [Install from Disk] window appears, insert the Printer Software CD-ROM disk into the CD-ROM drive.



- In the [Copy files from] field, enter D:\DRIVERS\W9598\Language for PostScript or PCL drivers (where D:\ is the drive letter of the CD-ROM) and click on [OK].
- Choose the printer model and driver required and click on [Next].

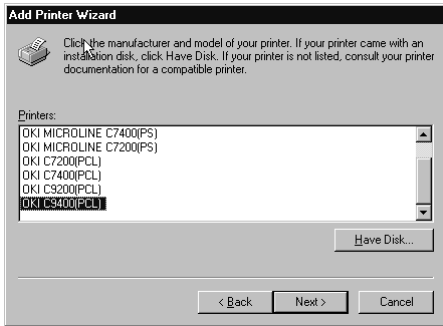

9. Among [Available Ports], select [LPT1:ECP Printer Port] and click on [Next].



10. Confirm printer name and specify if the printer is to be used as default printer or not, then click on [Next].



11. Specify if a test page is to be printed or not, then click on [Finish].
12. When the printer icon appears in the Printer folder, configuration is complete.

Windows NT 4.0

Note: Administrator's authority is required when installing under Windows NT 4.0.

1. Click on [Start]-[Settings]-[Printers].
2. Double-click on [Add Printer].
3. When the [Add Printer Wizard] appears, select [My computer] and click on [Next].



4. Among [Available Ports], select [LPT1:ECP Printer Port] and click on [Next].

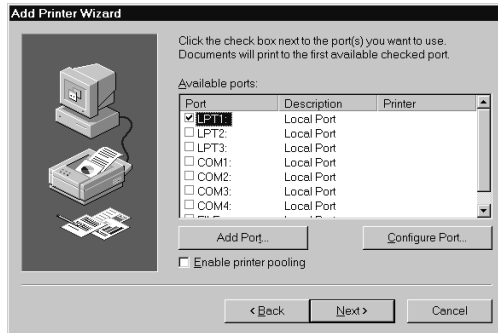

5. Click on [Have Disk...].

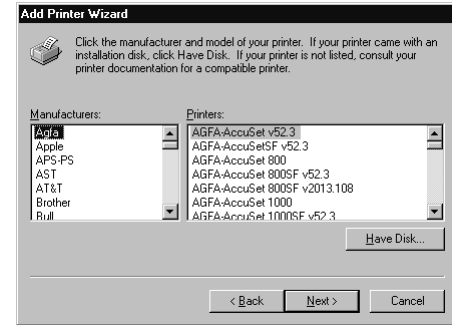

6. After the [Install from Disk] window appears, insert the Printer Software CD-ROM disk into the CD-ROM drive.

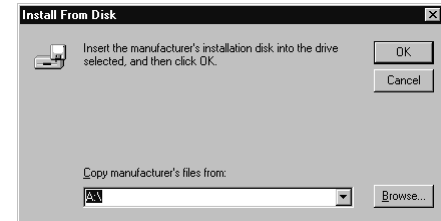

7. In the [Copy manufacturer's files from] field, enter D:\DRIVERS\NT40\Language for PostScript or PCL drivers (where D:\ is the drive letter of the CD-ROM) and click on [OK].

8. Choose the printer and click on [Next].

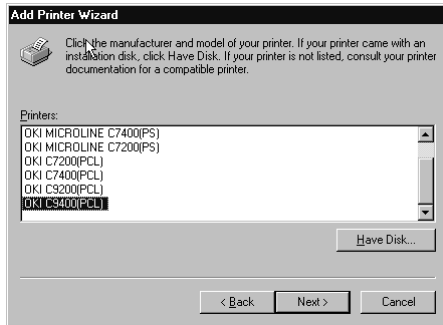

9. Confirm printer name and specify if the printer is to be used as default printer or not, then click on [Next].



10. Specify if the printer is to be shared or not, then click on [Next].

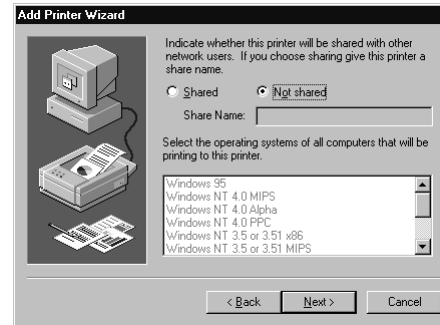

11. Specify if a test page is to be printed or not, then click on [Next], then click on [Finish].
12. When the printer icon appears in the Printer folder, configuration is complete.

USB interface

Note: *No USB interface cable is supplied with the printer. Please use a USB interface cable that is compatible with USB specification 1.1.*

General

A USB interface has the following restrictions:

- Will not operate using a MS-DOS or Windows 95/3.1/NT 4.0/NT 3.51 operating system.
- Will not operate using a Windows 98 operating system that has been upgraded from a Windows 95/3.1 operating system.
- Do not disconnect the USB interface cable during printing.
- Do not immediately disconnect and connect the USB cable or vice versa. Wait at least 5 seconds before re-connecting or disconnecting the cable.
- The operation of a printer is not assured if a USB compatible device is connected concurrently with other USB-compatible machines.
- When connecting multiple printers of the same type, they appear in the print folder as ***** (copy2), ***** (copy3), etc. These

numbers depend on the order of connecting or turning on each printer.

- If a USB hub is used, it is necessary to connect the USB hub directly to the computer.

Connection

1. Make sure the printer and computer are turned off.
2. Connect the USB interface cable into the USB port on the computer.
3. Connect the other end of the USB interface cable to the USB connector on the printer.
4. Turn the printer on, then turn the computer on.

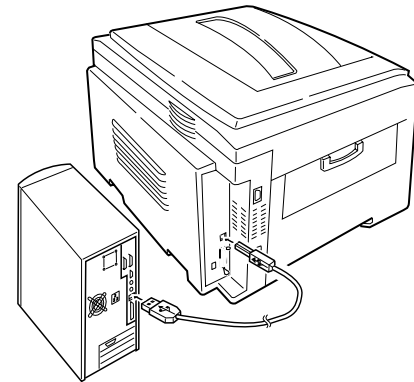

USB driver

Note: *Installation of USB driver is only required for Windows 98.*

1. After the [Add New Hardware Wizard] window appears, click on [Next].



2. Select [Search for the best driver for my device (Recommended)] and click on [Next].
3. Insert the printer software CD-ROM disk into the CD-ROM drive.
4. Make sure CD-ROM drive is checked and click on [Next].
5. After Windows finds the USB driver, click on [Next].



6. After files have finished copying, click on [Finish].
7. If the [Add New Hardware Wizard] window appears again, click on [Cancel] and restart the computer.

Plug and play configuration

Windows 2000

Note: *Administrator's authority is required when installing under Windows 2000.*

1. When the [Found New Hardware Wizard] appears, click on [Next].



2. Select [Search for the best driver for my device (Recommended)] and click on [Next].
3. Choose [Specify a location] and click on [Next].
4. Insert the printer software CD-ROM disk into the CD-ROM drive.

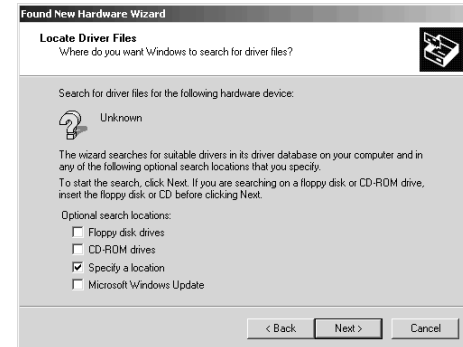

5. Uncheck [Floppy disk drive] and check [CD-ROM drive], then click on [Next] to install by default the PCL printer driver.

OR

To install another printer driver, uncheck both [Floppy disk drive] and [CD-ROM drive] and check [Specify a location]. Enter D:\DRIVERS\WIN2000\Language (where D:\ is the drive letter of the CD-ROM), then click on [Next] selecting the required printer driver.

6. Confirm that the printer driver is ready to be installed and click on [Next].

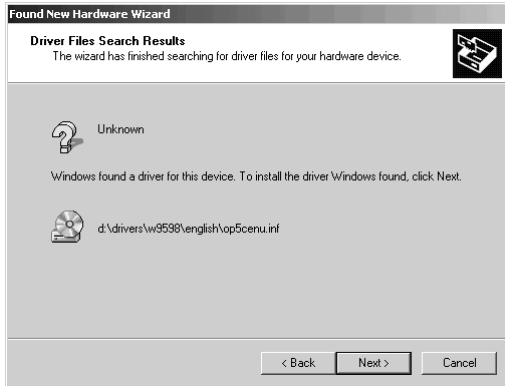

7. Specify if a test page is to be printed or not, then click on [Next] and click on [Finish].
8. In the [Digital Signature Not Found] window, click on [Yes]. File copying starts.

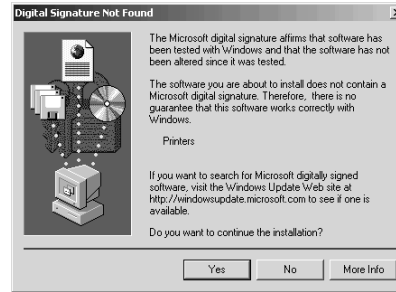

9. Choose [Start]-[Settings]-[Printers], then right click the printer icon and select [Set as Default Printer].

Windows 98 or Windows Me

1. After the [Add New Hardware Wizard] window appears, click on [Next].



- Choose [Search for the best driver for your device (Recommended)] and click on [Next].



- Insert the Printer Software CD-ROM disk into the CD-ROM drive.
- Uncheck [Floppy disk drive] and check [CD-ROM drive], then click on [Next] to install by default the PCL printer driver.

OR

For Windows 98 - To install another printer driver, uncheck both [Floppy disk drive] and [CD-ROM drive] and check [Specify a location]. Enter D:\DRIVERS\W9598\Language (where D:\ is the drive letter of the CD-ROM), then click on [Next] selecting the required printer driver.

OR

For Windows ME - Select the required driver from the displayed list in order to install the language required.

- After Windows finds the printer driver, click on [Next].
- Confirm the printer name and specify if the printer is to be the default printer or not, then click on [Next].

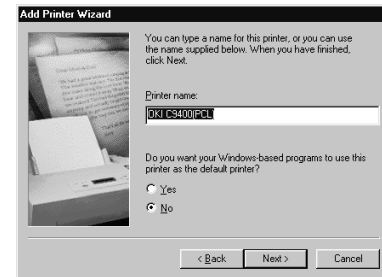

- Specify if a test page is to be printed or not, then click on [Finish].
- When the printer icon appears in the Printer folder, configuration is complete.

Add printer configuration

Windows 2000

Note: Administrator's authority is required when installing under Windows 2000.

1. Click on [Start]-[Settings]-[Printers].
2. Double-click on [Add Printer].
3. When the [Add Printer Wizard] appears, click on [Next].



4. Select [Local Printer], remove the check mark on [Automatically detect and install my Plug and Play printer] and click on [Next].

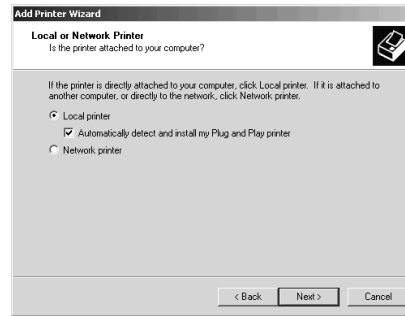

5. Select [Use the following port] and specify [USBxxx], then click on [Next].

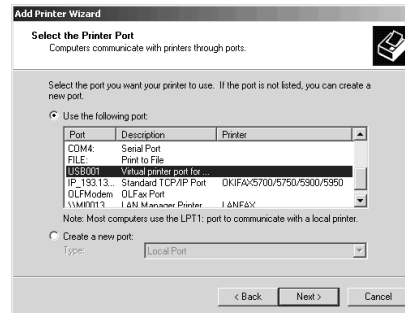

6. Click on [Have Disk...].

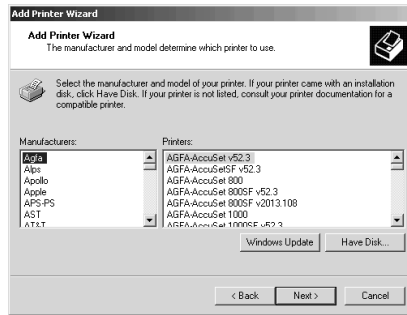

7. After the [Install from Disk] window appears, insert the Printer Software CD-ROM disk into the CD-ROM drive.

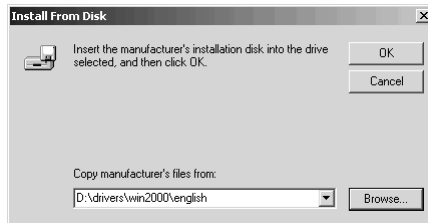

8. In the [Copy manufacturer's files from] field, enter D:\DRIVERS\WIN2000\Language for PostScript or PCL drivers (where D:\ is the drive letter of the CD-ROM) and click on [OK].

9. Choose the printer model and driver, then click on [Next].

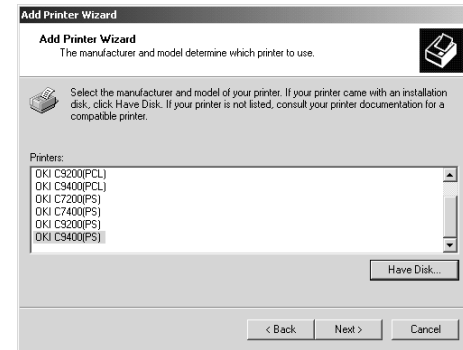

10. Confirm printer name and specify if the printer is to be used as default printer or not, then click on [Next].

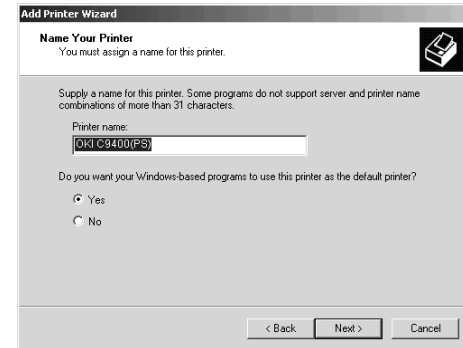

11. Specify if the printer is to be shared or not, then click on [Next].

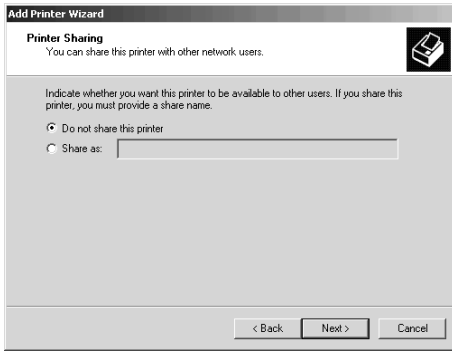

12. Specify if a test page is to be printed or not, then click on [Next], then click on [Finish].



13. In the [Digital Signature Not Found] window, click on [Yes]. File copying starts.
14. Choose [Start]-[Settings]-[Printers], then right click the printer icon and select [Set as Default Printer].

Windows 98

1. Click on [Start]-[Settings]-[Printers].
2. Double-click on [Add Printer].
3. When the [Add Printer Wizard] appears, click on [Next].

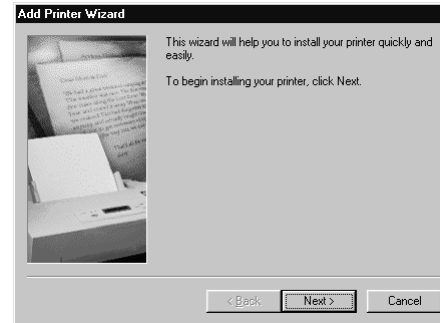

4. Select [Local Printer] and click on [Next].



5. Click on [Have Disk...].

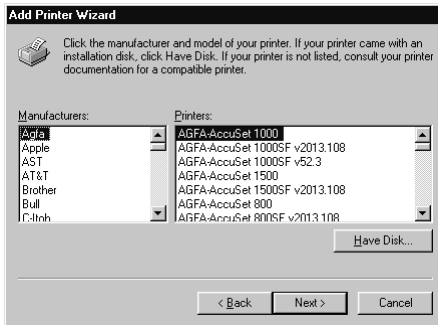

6. After the [Install from Disk] window appears, insert the Printer Software CD-ROM disk into the CD-ROM drive.



7. In the [Copy files from] field, enter D:\DRIVERS\W9598\Language for PostScript or PCL drivers (where D:\ is the drive letter of the CD-ROM) and click on [OK].

8. Choose the printer model and driver, then click on [Next].

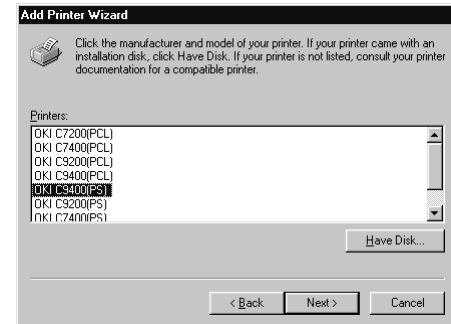

9. Among [Available Ports], select [OPIUSBx] and click on [Next].

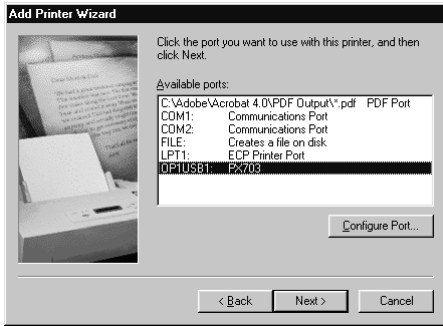

10. Confirm printer name and specify if the printer is to be used as default printer or not, then click on [Next].



11. Specify if a test page is to be printed or not, then click on [Finish].
12. When the printer icon appears in the Printer folder, configuration is complete.

Network connection

Note 1: *An optional Ethernet network interface card (NIC) is needed for connection to a network. For information on installing a network interface card, refer to Chapter 8 Optional Accessories.*

Note 2: *Administrator's authority is required when installing using a network connection.*

1. Confirm that the power is off to the printer.
2. Connect a network interface cable (twisted pair) into the NIC socket in the printer.
3. Connect the other end of the network interface cable into the network socket.
4. Switch on the printer.
5. Install the printer driver using the Add Printer Wizard and configure the printer driver to the network port the printer is connected to.
6. For further details on how to configure network connection, refer to the relevant section in the user's guide for the network interface card.

Internal hard disk

If your printer includes the hard disk, please use the following procedure to make sure that the hard disk has been enabled in the printer and printer driver.

Printer

1. Print a Menu Map as follows to confirm the hard disk is correctly installed.
 - (a) Press **Menu (0)** button twice to access the INFORMATION MENU.
 - (b) Press **Select (3)** button and confirm PRINT MENU MAP is displayed on the LCD.
 - (c) Press **Select (3)** button to print the menu map.
 - (d) Check that HDD now shows installed in the printer.
2. After installation, the hard disk has to be initialised as follows:
 - (a) Press **Menu (0)** button until DISK MAINTENANCE is displayed, then press **Select (3)** button.

- (b) When HDD INITIALISE is displayed, press **Select (3)** button.
- (c) Press **Item (1)** button to shutdown the printer. The printer has to be switched off and back on again to initialise the hard disk before use.

Printer driver

Windows 2000/NT 4.0 PostScript

1. Click on [Start] - [Settings] - [Printers].
2. Highlight the printer name and click on [File] then [Properties].

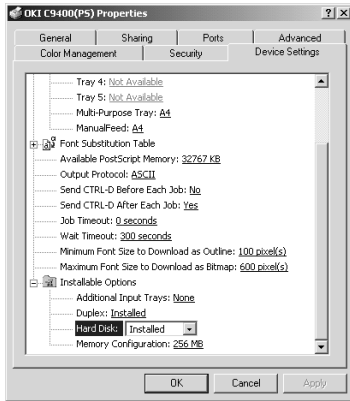

3. Click on [Device Settings] tab.
4. Highlight [Hard Disk], then select [Installed] and click on [OK].

Windows 2000 PCL

1. Click on [Start] - [Settings] - [Printers].
2. Highlight the printer name and click on [File] then [Properties].
3. Click on [General] tab, [Printing Preferences] button, then [Device Options] button.

OR

Click on [Advanced] tab, [Printing Defaults] button, then [Device Options] button..

4. Check [Printer Hard Disk] and click on [OK] three times.

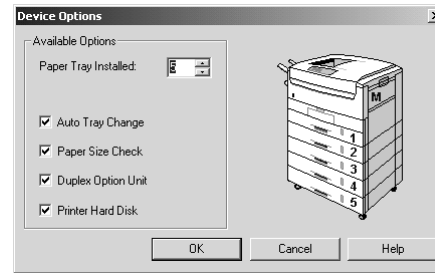

Windows 98/95 PostScript

1. Click on [Start] - [Settings] - [Printers].
2. Highlight the printer name and click on [File] then [Properties].
3. Click on the [Device Options] tab.
4. Highlight [Hard Disk], then select [Installed] and click on [OK].

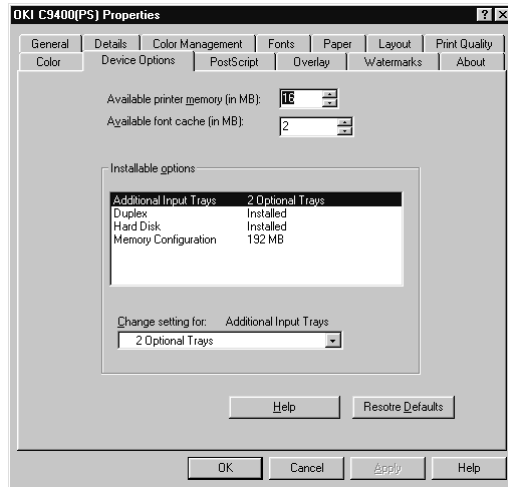

Windows 98/95/NT 4.0 PCL

1. Click on [Start] - [Settings] - [Printers].
2. For Windows 98/95 - Highlight the printer name and click on [File] then [Properties].
For Windows NT 4.0 - Highlight the printer name and click on [File] then [Document Default].
3. Click on the [Paper] tab, then the [Device Options] button.
4. Check [Printer Hard Disk] and click on [OK] twice.

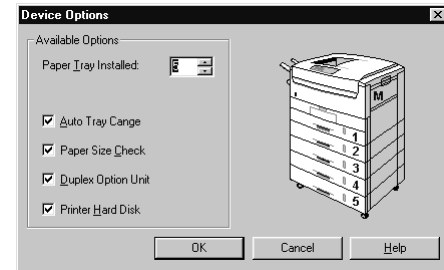

Duplex unit

If your printer includes the duplex unit, please use the following procedure to make sure that duplex printing has been enabled in the printer and printer driver.

Printer

1. Press **Menu (0)** button until PRINT MENU is displayed, then press **Select (3)** button.
2. Press **Item (1)** button until DUPLEX is displayed.
3. Press **Value (2)** button until ON is displayed and press **Select (3)** button. An asterisk (*) appears to show that duplex has been set to on.
4. Press **Online (4)** button to turn the printer back on line.

Printer driver

Windows 2000/NT 4.0 PostScript

1. Click on [Start] - [Settings] - [Printers].
2. Highlight the printer name and click on [File] then [Properties].

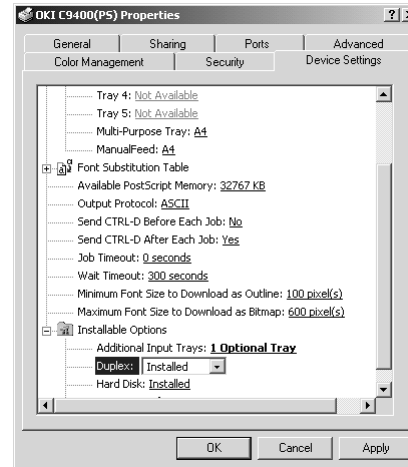

3. Click on [Device Settings] tab.
4. Highlight [Duplex], then select [Installed] and click on [OK].

Windows 2000 PCL

1. Click on [Start] - [Settings] - [Printers].
2. Highlight the printer name and click on [File] then [Properties].

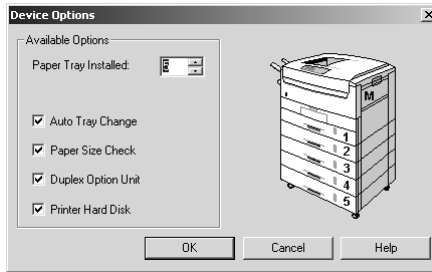

3. Click on [General] tab, [Printing Preferences] button, then [Device Options] button.

OR

Click on [Advanced] tab, [Printing Defaults] button, then [Device Options] button..

4. Check [Duplex Option Unit] and click on [OK] three times.

Windows 98/95 PostScript

1. Click on [Start] - [Settings] - [Printers].
2. Highlight the printer name and click on [File] then [Properties].
3. Click on the [Device Options] tab.

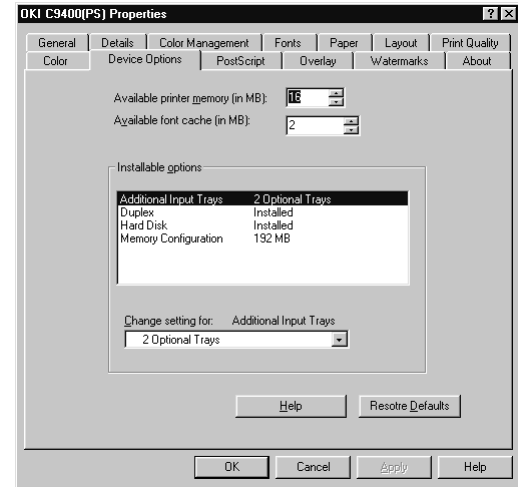

4. Highlight [Duplex], then select [Installed] and click on [OK].

Windows 98/95/NT 4.0 PCL

1. Click on [Start] - [Settings] - [Printers].
2. For Windows 98/95 - Highlight the printer name and click on [File] then [Properties].

For Windows NT 4.0 - Highlight the printer name and click on [File] then [Document Default].

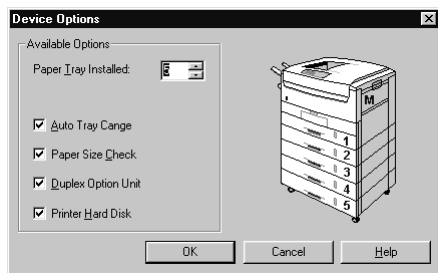

3. Click on the [Paper] tab, then the [Device Options] button.
4. Check [Duplex Option Unit] and click on [OK] twice.

Chapter 3 - Macintosh Setup

USB connection

Operating environment

- MacOS 8.5 or higher running on a Macintosh computer with a USB interface.
 - Do not disconnect the USB interface cable during printing.
 - Do not immediately disconnect and connect the USB cable or vice versa. Wait at least 5 seconds before re-connecting or disconnecting the cable.
 - The operation of the printer is not assured if a USB compatible device is connected concurrently with other USB compatible machines.
 - When connecting multiple printers of the same type, the Chooser displays *****1, *****2, *****3, etc. These numbers depend on the order of connecting or turning on each printer.
- If a USB hub is used, it is necessary to connect the USB hub directly to the computer.
 - If the memory setting for the print monitor is low and depending on the document, background printing may not be able to be carried out. Increase the memory setting for the print monitor to carry out background printing without problems.
 - Depending on the model of computer, updates to the operating system may be needed, e.g. iMac Update 1.0, iMac Update 1.1, iMac Firmware Update, etc. For information on the latest updates and installation, contact Apple Computers.

Connection

Note: *No USB interface cable is supplied with the printer. Please use a USB interface cable that is compatible with USB specification 1.1.*

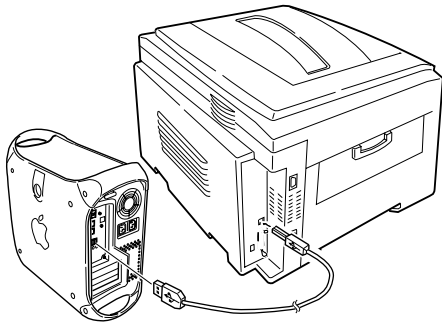

1. Make sure the printer and computer are turned off.
2. Connect the USB interface cable into the USB port on the computer.
3. Connect the other end of the USB interface cable to the USB connector on the printer.
4. Turn the printer on, then turn the computer on.

Printer driver installation

Note: Switch off antivirus software before installing a printer driver.

1. Place the software CD-ROM in the CD-ROM drive.

2. Open [Drivers] and open the required language folder.

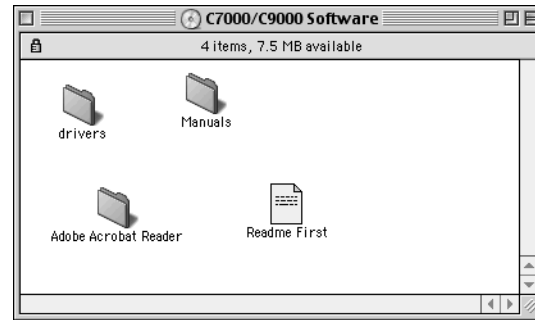

3. Double-click on [Adobe PS Installer].

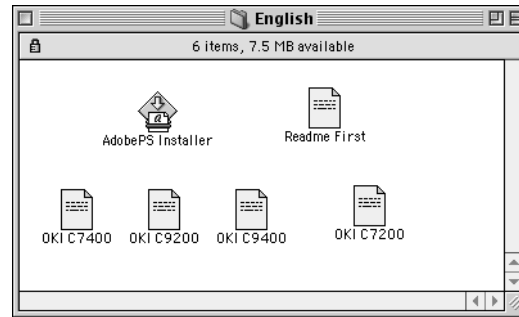

4. Click on [Continue] in the Adobe PostScript Driver screen and follow the on screen instructions.

- When installation of the printer driver is complete, click on [Restart] button.
- After the computer has restarted the Adobe PS icon should appear in the Chooser.

Creating desktop printer

- In the Adobe PS Components folder at the top directory level of your hard disk, double-click on [Desktop Printer Utility].

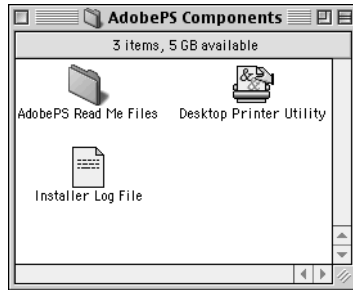

Note: Installing Adobe PS printer driver also installs Desktop Printer Utility in the Adobe PS Components folder.

- Select [Printer (USB)] and click on [OK].

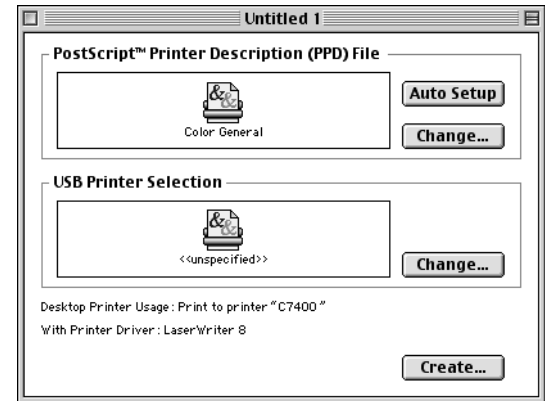

- Click on [Change] button in [PostScript Printer Description (PPD) file].

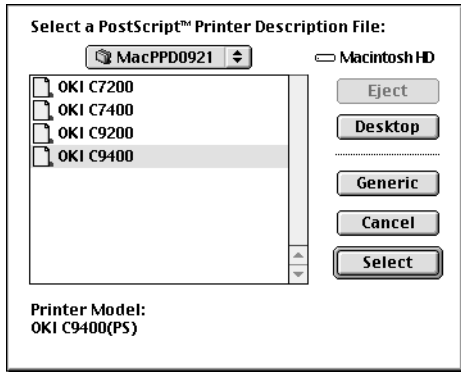

4. Select the PPD for the printer from the Drivers:language folder on the CD.
5. In [USB printer selection], click on [Change] button.
6. Select the printer then click on [OK].

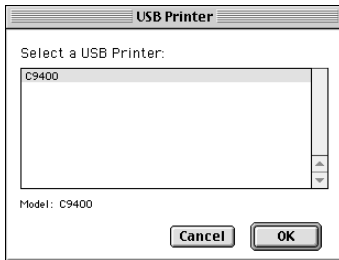

7. Click on [Create] button, enter the printer name , then click on the [Save] button.

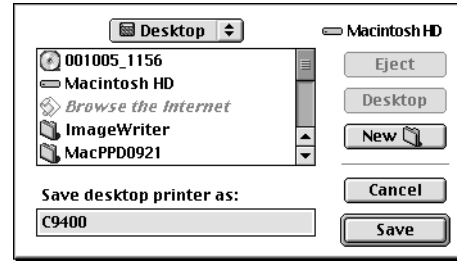

Note: The printer icon should appear on the desktop.

8. Close the Desktop Printer Utility.

Network connection

Note 1: *An optional Ethernet network interface card (NIC) is needed for connection to a network. For information on installing a network interface card, refer to Chapter 8 Optional Accessories.*

Note 2: *Administrator's authority is required when installing using a network connection.*

Operating environment

MacOS 8.5 or above, running on a Macintosh computer with EtherTalk interface.

Connection

1. Confirm that the power is off to the printer.
2. Connect a network interface cable (twisted pair) into the NIC socket in the printer.
3. Connect the other end of the network interface cable into the network socket.
4. Switch on the printer.
5. For further details on how to configure network connection, refer to the relevant section in the user's guide for the network interface card.

Printer driver installation

Either the Adobe PostScript printer driver or Laser-Writer printer driver can be used. However, for the Adobe PostScript printer driver 8.7, only MacOS 8.5 or higher can be used.

1. Place the Printer Software CD-ROM in the CD-ROM drive.
2. Open the [Driver] folder.
3. Double-click on [Adobe PS Installer].
4. Click [Continue] in the Adobe PostScript Diver screen and follow the on screen instructions.
5. After installation of the driver, restart the computer and the Adobe PS icon should appear in the Chooser.
6. Open [Chooser] in the Apple menu.
7. Click on [Adobe PS] and select Printer name.

Note 1: *If using an Ethernet network interface card, the printer name is OP and the last six digits of the Ethernet address.*

Note 2: *Printer name is given as Object name in the self diagnostic test for the network interface card.*

8. Click on [Create] and an icon should appear beside the printer name.
9. Close [Chooser].

Note: *The printer icon should appear on the desktop.*

Internal hard disk

If your printer includes the hard disk, please use the following procedure to make sure that the hard disk has been enabled in the printer and printer driver.

Printer

1. Print a Menu Map as follows to confirm the hard disk is correctly installed.
 - (a) Press **Menu (0)** button twice to access the INFORMATION MENU.
 - (b) Press **Select (3)** button and confirm PRINT MENU MAP is displayed on the LCD.
 - (c) Press **Select (3)** button to print the menu map.
 - (d) Check that HDD now shows installed in the printer.
2. After installation, the hard disk has to be initialised as follows:
 - (a) Press **Menu (0)** button until DISK MAINTENANCE is displayed, then press **Select (3)** button.

- (b) When HDD INITIALISE is displayed, press **Select (3)** button.
- (c) Press **Item (1)** button to shutdown the printer. The printer has to be switched off and back on again to initialise the hard disk before use.

Printer driver

Macintosh USB connection

1. Drag the printer icon from the desktop into the waste bin and empty the waste bin.
2. Create a new desktop printer and the settings will be updated automatically.

Macintosh network connection

1. Open [Chooser], click on [Adobe PS] and select the printer.
2. Click on [Setup] - [Configure].
3. Select [Hard disk] from [Installable options] and then select [Installed] from the drop down list.
4. Click on [OK] button twice and close [Chooser] to complete the re-configuration of the printer driver.

Duplex unit

If your printer includes the duplex unit, please use the following procedure to make sure that duplex printing has been enabled in the printer and printer driver.

Printer

1. Press **Menu (0)** button until PRINT MENU is displayed, then press **Select (3)** button.
2. Press **Item (1)** button until DUPLEX is displayed.
3. Press **Value (2)** button until ON is displayed and press **Select (3)** button. An asterisk (*) appears to show that duplex has been set to on.
4. Press **Online (4)** button to turn the printer back on line.

Printer driver

Macintosh USB connection

1. Drag the printer icon from the desktop into the waste bin and empty the waste bin.
2. Create a new desktop printer and the settings will be updated automatically.

Macintosh network connection

1. Open [Chooser], click on [Adobe PS] and select the printer.
2. Click on [Setup] - [Configure].
3. Select [Duplex] from [Installable options] and then select [Installed] from the drop down list.
4. Click on [OK] button twice and close [Chooser] to complete the re-configuration of the printer driver.

Index

A

Add printer configuration 18, 32

C

Components 3

Connection

Parallel interface 14

Power cable 10

USB interface 27, 44

Control panel 5

D

Desktop printer 45

Display language 11

Duplex printing 40, 49

H

Hard disk 37, 48

L

Location 6

M

Macintosh

Connection 44

Creating desktop printer 45

Duplex option 49

Hard disk 49

Network connection 47

Printer driver installation 44, 47

USB interface 43

Menu settings 12

N

Network connection 37, 47

P

Paper

Loading 9

Parallel interface 14

Plug and play configuration 15, 29

Power cable 10

Printer	
Changing display language	11
Components	3
Control panel	5
Location	6
Menu settings	12
Setting up	6
Unpacking	2
Printer driver	
Installation	13, 44
Parallel interface connection	14
Types	13
USB interface connection	27
Protective sheet removal	6

S

Setting up	
Loading paper	9
Power cable	10
Protective sheet removal	6
Toner cartridge installation	8

T

Toner cartridge installation	8
--	---

U

Unpacking	2
USB driver	28
USB interface	27, 43

W

Windows	
Add printer configuration	18, 32
Duplex option	40
Hard disk	38
Network connection	37
Parallel interface	14
Plug and play configuration	15, 29
Printer driver installation	13
Printer driver types	13
USB driver	28
USB interface	27

OKI SYSTEMS COMPANIES

Oki Systems (UK) Ltd
550 Dundee Road, Slough Trading Estate
Slough, Berkshire SL1 4LE
UNITED KINGDOM

Tel: +44 (0) 1753 819 819
Fax: +44 (0) 1753 819 899

<http://www.oki.co.uk>

Oki Systems (Ireland) Limited
The Square Industrial Complex
Tallaght, Dublin 24
EIRE

Tel: +353 (01) 459 8666
Fax: +353 (01) 459 8840

<http://www.oki.ie>

Hawthorn Business Centre
Adelaide Industrial Estate
Falcon Road, Belfast BT12 6HP
NORTHERN IRELAND

Tel: +44 (028) 9057 2355
Fax: +44 (028) 9057 2350

<http://www.oki.ie>

Oki Data Corporation
4-11-22, Shibaura, Minato-ku, Tokyo 108-8551
JAPAN

Tel: +81 (0) 3 5445 6111
Fax: +81 (0) 3 5445 6182

Oki Data (Hong Kong) Ltd.
Suite 1909B, Tower 3, China Hong Kong City
33 Canton Road, Tsim Sha Tsui, Kowloon
HONG KONG

Tel: +852 2736 0130
Fax: +852 2736 2395

Oki Data (Singapore) Pte., Ltd.
78 Shenton Way, #09-01
SINGAPORE 079120

Tel: +65 221 3722
Fax: +65 221 9282

Oki Systems (Thailand) CO. Ltd
956 Udomvidhya Building 6th Floor, Rama IV Road
Silom, Bangkok 10500
THAILAND

Tel: +662 636 2535
Fax: +662 636 2536

