

# HP Photosmart E217 Digital Camera



## User's Manual





## Legal and notice information

© Copyright 2005 Hewlett-Packard Development Company, L.P.

The information contained herein is subject to change without notice. The only warranties for HP products and services are set forth in the express warranty statements accompanying such products and services. Nothing herein should be construed as constituting an additional warranty. HP shall not be liable for technical or editorial errors or omissions contained herein.

Windows® is a U.S. registered trademark of Microsoft Corporation.



SD Logo is a trademark of its proprietor.

**Important recycling information for our customers in the European Union:** To preserve the environment, this product must be recycled after its useful life as required by law. The symbol below indicates that this product may not be disposed in the general trash. Please return the product for proper recovery/disposal to the authorized collection location nearest to you. For more information regarding return and recycling of HP products generally, please visit:

[www.hp.com/hpinfo/globalcitizenship/environment/recycle/index.html](http://www.hp.com/hpinfo/globalcitizenship/environment/recycle/index.html)



### For future reference, please enter the following information:

Model Number (on the front of the camera) \_\_\_\_\_

Serial Number (10-digit number on the bottom of the camera) \_\_\_\_\_

Date the camera was purchased \_\_\_\_\_

Printed in China



---

# Contents

1	Getting Started . . . . .	9
	Setup . . . . .	10
	1 Attach the Wrist Strap . . . . .	10
	2 Install the Batteries . . . . .	11
	3 Turn on the Camera . . . . .	12
	4 Choose the Language. . . . .	13
	5 Set the Date and Time . . . . .	14
	6 Install and Format a Memory Card (Optional). . . . .	15
	7 Install the Software. . . . .	17
	Windows®. . . . .	17
	Macintosh. . . . .	18
	User's Manual on the CD . . . . .	18
	Camera Parts . . . . .	19
	Back of the Camera. . . . .	19
	Top of the Camera . . . . .	21
	Front, Left Side, and Bottom of the Camera. . .	22
	Camera States . . . . .	24
	Camera Menus . . . . .	24
2	Taking Pictures and Recording Video Clips. . .	27
	Using Live View . . . . .	27
	Taking Still Pictures . . . . .	29
	Recording Video Clips. . . . .	30
	Using Digital Zoom. . . . .	31
	Setting the Flash . . . . .	32
	Using the Focus Modes . . . . .	34
	Using the Self-Timer Settings. . . . .	35
	Using the Capture Menu . . . . .	37
	Shooting Modes . . . . .	38

Image Quality . . . . .	40
Date & Time Imprint . . . . .	42
EV Compensation . . . . .	44
White Balance . . . . .	45
ISO Speed . . . . .	47
<b>3 Reviewing Images and Video Clips . . . . .</b>	<b>49</b>
Using Playback . . . . .	49
Total Images Summary Screen . . . . .	52
Using the Playback Menu . . . . .	53
Delete . . . . .	55
Viewing Thumbnails . . . . .	56
Magnifying Images . . . . .	57
Print . . . . .	58
Rotate . . . . .	59
Record Audio . . . . .	60
<b>4 Transferring and Printing Images . . . . .</b>	<b>61</b>
Transferring Images to a Computer . . . . .	61
Printing Images Directly from the Camera . . . . .	62
<b>5 Using the Setup Menu . . . . .</b>	<b>65</b>
Display Brightness . . . . .	66
Camera Sounds . . . . .	67
Date & Time . . . . .	68
USB Configuration . . . . .	69
Language . . . . .	70
Move Images to Card . . . . .	71
Reset Settings . . . . .	72
<b>6 Troubleshooting and Support . . . . .</b>	<b>73</b>
Resetting the Camera . . . . .	74
HP Image Zone Software . . . . .	75
System Requirements (Windows Only) . . . . .	75
HP Image Zone Express (Windows Only) . . . . .	76

Using Your Camera without Installing the HP Image Zone Software . . . . .	77
Transferring Images to a Computer without HP Image Zone Software . . . . .	77
Connecting Your Camera as a Digital Camera . . . . .	77
Using a Memory Card Reader . . . . .	78
Configuring the Camera as a Disk Drive . .	81
Problems and Solutions . . . . .	83
Error Messages on the Camera . . . . .	95
Error Messages on the Computer . . . . .	104
Getting Assistance . . . . .	106
HP Accessibility Website . . . . .	106
HP Photosmart Website . . . . .	106
Support Process . . . . .	106
Phone Support . . . . .	107
Phone Support Numbers . . . . .	109
<b>A Managing Batteries . . . . .</b>	<b>111</b>
Top Points About Batteries . . . . .	111
Extending Battery Life . . . . .	112
Safety Precautions for Using Batteries . . . . .	112
Performance per Battery Type . . . . .	114
Number of Shots per Battery Type . . . . .	115
Power Indicators . . . . .	116
Recharging NiMH Batteries . . . . .	117
Safety Precautions for Recharging NiMH Batteries . . . . .	119
Sleep Time-out for Power Conservation . . . . .	119
<b>B Purchasing Camera Accessories . . . . .</b>	<b>121</b>

C	Caring for Your Camera . . . . .	123
	Basic Camera Care . . . . .	123
	Cleaning the Camera . . . . .	125
	Cleaning the Camera Lens . . . . .	125
	Cleaning the Camera Body and Image Display . . . . .	126
D	Specifications . . . . .	127
	Memory Capacity . . . . .	131



---

# 1 Getting Started

Congratulations on your purchase of the HP Photosmart E217 digital camera and welcome to the world of digital photography!

This manual explains camera features you can use to ensure great results while enjoying the photographic experience. Some of these features are:

- **Video and audio capability**—Record video clips (see page 30) or add audio clips to your still pictures (see page 60).
- **Transferring images to a computer**—Easily transfer images from your camera to your computer. See page 61.
- **Direct print**—Print directly from your camera to any PictBridge-certified printer without having to connect to your computer. See page 62.
- **Internal memory or memory card**—Store images in your camera's internal memory or on an optional memory card of your choice. See page 15.

# Setup

To locate a part on your camera (such as a button or a light) while following the instructions in this section, see **Camera Parts** on page 19.

## 1. Attach the Wrist Strap

Attach the wrist strap to the wrist strap mount on the side of the camera as shown.



## 2. Install the Batteries

1. Open the Battery/Memory card door on the side of the camera by sliding the door toward the front of the camera.
2. Insert the batteries as indicated inside the door.
3. Close the Battery/Memory card door by pushing the door down and sliding the door toward the back of the camera until the door latches.



For the performance of NiMH, Lithium, and Alkaline batteries when used with this camera, see **Performance per Battery Type** on page 114. For the number of shots you can expect to get for each battery type based on usage, see **Number of Shots per Battery Type** on page 115. For hints on optimizing battery performance, see **Appendix A, Managing Batteries**, starting on page 111.

**TIP:** If you use rechargeable NiMH batteries, you can recharge the batteries in the optional HP Photosmart quick recharger. For more information, see **Appendix B, Purchasing Camera Accessories**, starting on page 121.

### 3. Turn on the Camera

To turn the camera on, slide the lens cover open until it clicks, uncovering the lens. The Power/Memory light on the back of the camera turns on solid green. The HP logo also displays on the Image Display as the camera powers up.





To turn the camera off, slide the lens cover closed until it clicks, covering the lens.

**CAUTION:** When sliding the lens cover, keep your fingers clear of the lens. Fingerprints on the lens can impair the quality of the picture. For information about cleaning the lens, see **Cleaning the Camera** on page 125.

## 4. Choose the Language

The first time you turn the camera on, you are prompted to choose a language.

1. Scroll to the language that you want by using the ▲▼◀▶ buttons on the **Controller** .
2. Press the  button to select the highlighted language.



**TIP:** If you need to change the language later, you can do this with the **Language** setting in the **Setup** menu. See **Chapter 5, Using the Setup Menu**.

## 5. Set the Date and Time

The camera has a clock that records the date and time at which you take each picture. This information is recorded in the image properties, which you can see in **Playback**, when viewing **Image Advice**, and when viewing the image on your computer. You can also choose to have the date and time imprinted on the image (see **Date & Time Imprint** on page 42).

1. The first item highlighted is the date and time format. If you want to change the format, use the ▲▼ buttons. If the date and time format is correct, press the ► button to move to the next selection.

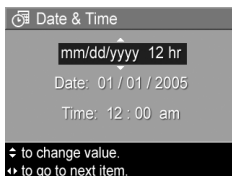

2. Adjust the value of the highlighted selection using the ▲▼ buttons.
3. Press the ◀▶ buttons to move to the other selections.
4. Repeat Steps 2 and 3 until the date and time are set correctly.
5. Press the  $\frac{\text{Menu}}{\text{OK}}$  button when you have entered the proper values for the date and time. A confirmation screen appears, asking if the correct date and time have been set. If the date and time are correct, press the  $\frac{\text{Menu}}{\text{OK}}$  button to select **Yes**.

If the date and time are incorrect, press the ▼ button to highlight **No**, and then press the  $\frac{\text{Menu}}{\text{OK}}$  button. The **Date & Time** screen appears again. Repeat Steps 1 through 5 to set the correct date and time.

**TIP:** If you need to change the date and time settings later, you can do this with the **Date & Time** setting in the **Setup** menu. See **Chapter 5, Using the Setup Menu**.

## 6. Install and Format a Memory Card (Optional)

Your camera contains internal memory that allows you to store images and video clips. However, you can use a memory card (purchased separately) instead to store images and video clips. For more information about supported memory cards, see **Storage** on page 129.

1. Turn off the camera and open the Battery/Memory card door on the side of the camera.
2. Insert the memory card in the small slot behind the batteries, with the notched end of the card going in first, as shown. Make sure the memory card snaps into place.
3. Close the Battery/Memory card door and turn on the camera.
4. Press the  $\frac{\text{Menu}}{\text{OK}}$  button, then use the  $\blacktriangleright$  button to move to the **Playback Menu**  $\blacktriangleright$ .
5. Press the  $\blacktriangledown$  button to highlight **Delete**, and then press the  $\frac{\text{Menu}}{\text{OK}}$  button to display the **Delete** sub-menu.
6. Use the  $\blacktriangledown$  button to highlight **Format Card**, and then press the  $\frac{\text{Menu}}{\text{OK}}$  button to display the **Format Card** confirmation screen.



7. Press the ▼ button to highlight **Yes**, and then press the  button to format the card.

**Formatting Card...** appears in the Image Display while the camera is formatting the memory card. When the camera has completed the formatting, the Total Images Summary screen is displayed (see **Total Images Summary Screen** on page 52).

To remove the memory card from the camera, first turn the camera off. Then open the Battery/Memory card door, press down on the top edge of the memory card, and it will spring outward from the slot.

**NOTE:** When you install a memory card in the camera, all new images and video clips will be stored on the card, and you will no longer be able to view images stored in the camera's internal memory. To use internal memory and view images stored there, remove the memory card, or transfer the images from the internal memory to the memory card (see **Move Images to Card** on page 71).



## 7. Install the Software

The HP Image Zone software allows you to transfer images.

**NOTE:** If you do not install the HP Image Zone software, you can still transfer images. For details, see **Using Your Camera without Installing the HP Image Zone Software** on page 77.

**NOTE:** If you have trouble installing or using the HP Image Zone software, see the HP Customer Support website: **[www.hp.com/support](http://www.hp.com/support)** for more information.

### Windows®

To install the HP Image Zone software successfully, your computer must have a minimum of 64MB of RAM, Windows 2000, XP, 98, 98 SE, or Me, and Internet Explorer 5.5 Service Pack 2 or higher. Internet Explorer 6 is recommended. If your computer meets these requirements, the installation process installs either the full version of HP Image Zone or HP Image Zone Express. For differences between these, see **HP Image Zone Software** on page 75 and **HP Image Zone Express (Windows Only)** on page 76.

1. Close all programs and temporarily disable any virus protection software running on your computer.
2. Insert the HP Image Zone software CD into the CD drive of your computer and follow the on-screen instructions. If the installation screen does not appear, click **Start**, click **Run**, type **D:\Setup.exe**, where **D** is the letter of your CD drive, then click **OK**.
3. When the HP Image Zone software has finished installing, re-enable the virus protection software you disabled in Step 1.

## Macintosh

1. Close all programs and temporarily disable any virus protection software running on your computer.
2. Insert the HP Image Zone software CD into the CD drive of your computer.
3. Double-click the CD icon on the computer desktop.
4. Double-click the installer icon, and then follow the on-screen instructions.
5. When the HP Image Zone software has finished installing, re-enable the virus protection software you disabled in Step 1.

## User's Manual on the CD

A copy of this camera User's Manual in different languages is located on the HP Image Zone software CD. To view your camera User's Manual:

1. Insert the HP Image Zone software CD into the CD drive of your computer.
2. **On Windows:** Click **View User's Manual** on the Main page of the CD installation screen to view the User's Manual.

**On Macintosh:** Look in the **readme** file in the **docs** folder of the HP Image Zone software CD to locate the User's Manual in your language.



**NOTE:** For an interactive learning experience (in English) that will guide you through the most-used features of your camera and provide basic digital photography tips, please install and run the Interactive User's Guide program from your software CD.





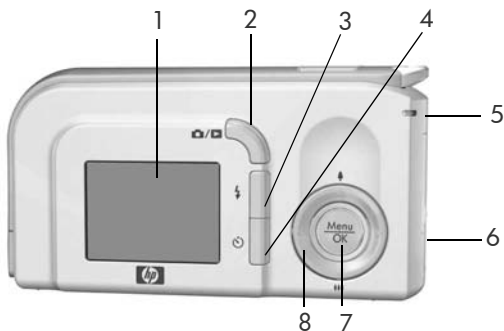







# Camera Parts

Refer to the pages in parentheses after the part names in the following tables for more information about those parts.

## Back of the Camera



#	Name	Description
1	Image Display (page 27)	Allows you to frame pictures and video clips using <b>Live View</b> and review them afterward in <b>Playback</b> , and to view all the menus.
2	 /  <b>Live View/Playback</b> button	<ul style="list-style-type: none"><li>• If <b>Live View</b> is displayed, allows you to switch to <b>Playback</b>.</li><li>• If <b>Playback</b> is displayed, allows you to switch to <b>Live View</b>.</li><li>• If the Image Display is off, but the camera is on, allows you to turn the Image Display on.</li><li>• If a menu is open in the Image Display, allows you to close the menu.</li></ul>

#	Name	Description
3	 <b>Flash</b> button (page 32)	Allows you to select between the different flash settings.
4	 <b>Self-Timer</b> button (page 35)	Allows you to take a self-timer picture.
5	Power/Memory light	<ul style="list-style-type: none"> <li>• <b>Solid green</b>—Camera is on.</li> <li>• <b>Blinking green</b>—Camera is writing to either the internal memory or an installed memory card.</li> </ul>
6	Battery/Memory card door (pages 11, 15)	Allows access to insert and remove the batteries and an optional memory card.
7	 button (pages 37, 53)	Allows you to display camera menus, select menu options, and confirm certain actions on the Image Display.
8	 <b>Controller</b> with  and  buttons	<ul style="list-style-type: none"> <li>•  buttons—Allows you to scroll vertically through menus.</li> <li>•  buttons—Allows you to scroll horizontally through menus and images on the Image Display.</li> <li>•  <b>Zoom In</b> ( button)—While in <b>Live View</b>, allows you to digitally zoom the picture to a lower resolution while taking still pictures (page 31).</li> <li>•  <b>Zoom Out</b> ( button)—While in <b>Live View</b>, allows you to digitally zoom the picture to a higher resolution while taking still pictures (page 31).</li> </ul>

## Top of the Camera



#	Name	Description
1	<b>Shutter</b> button (page 29)	Takes a picture.
2	Wrist strap mount (page 10)	Allows you to attach a wrist strap to the camera.
3	 <b>Video</b> button (page 30)	Starts and stops recording a video clip.

# Front, Left Side, and Bottom of the Camera

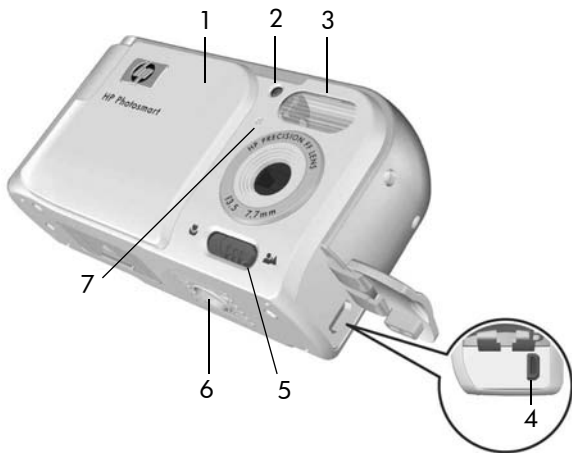



#	Name	Description
1	Lens cover/Power switch (page 12)	Turns the camera on and off and protects the lens when the camera is off.
2	Self-Timer/Video light (pages 30, 35)	Blinks during the count-down before taking a picture when the camera is set to <b>Self-Timer</b> . Also turns on solid when recording video.
3	Flash (page 32)	Provides additional light to improve picture-taking.
4	 USB connector (pages 61, 62)	Allows you to connect a USB cable from the camera to a USB-enabled computer or any PictBridge-certified printer.

#	Name	Description
5	Focus Mode switch (page 34)	Allows you to switch between <b>Normal</b> and <b>Macro</b> focus mode.
6	Tripod mount	Allows you to mount the camera on a tripod.
7	Microphone (page 34)	Records audio clips that are attached to still images and the audio portion of video clips.

# Camera States

Your camera has two main states that allow you to complete certain tasks.

- **Live View**—Allows you to take still pictures and record video clips. For information about using **Live View** , see **Chapter 2, Taking Pictures and Recording Video Clips**, starting on page 27.
- **Playback**—Allows you to review the still images and video clips that you capture. For information about using **Playback** , see **Chapter 3, Reviewing Images and Video Clips**, starting on page 49.



To switch between **Live View** and **Playback** states, press the **Live View/Playback**  /  button.

# Camera Menus

Your camera has three menus that, when accessed, appear in the Image Display on the back of the camera.

To access the menus, press the  $\frac{\text{Menu}}{\text{OK}}$  button, then use the  $\blacktriangleleft$   $\blacktriangleright$  buttons to move to the menu you want. To select a menu option, use the  $\blacktriangleup$   $\blacktriangledown$  buttons to highlight it, then press the  $\frac{\text{Menu}}{\text{OK}}$  button to display the menu option's sub-menu and modify the settings.

To exit a menu, you can do one of the following:

- Press the **Live View/Playback**  /  button.
- Use the  $\blacktriangleup$   $\blacktriangledown$  buttons to scroll to the  **EXIT** menu option and press the  $\frac{\text{Menu}}{\text{OK}}$  button.

**TIP:** In the **Capture** and **Setup Menus**, you can modify settings by highlighting the menu option and using the  $\blacktriangleleft$   $\blacktriangleright$  buttons to change the setting.



The **Capture Menu**  lets you specify settings for taking a picture such as image quality, ISO speed, and imprinting the date and time on the images. For information about using this menu, see **Using the Capture Menu** on page 37.

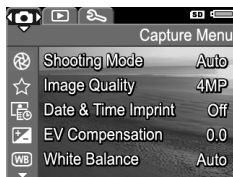

The **Playback Menu**  lets you magnify and rotate images, add audio clips to images, select images for printing, and delete images. For information about using this menu, see **Using the Playback Menu** on page 53.



The **Setup Menu**  lets you modify configuration settings such as display brightness, date and time, and language, among others. It also allows you to move images from the internal memory to an optional memory card. For information about using this menu, see **Chapter 5, Using the Setup Menu**, starting on page 65.









---

## 2 Taking Pictures and Recording Video Clips



### Using Live View

The Image Display allows you to frame pictures and video clips using **Live View**. To activate **Live View** when the Image Display is off, press the **Live View/Playback**  /  button until the **Live View**  icon appears in the upper left corner of the Image Display.

**TIP:** To conserve battery life, the Image Display shuts down during periods of inactivity when the camera is on. You can activate the Image Display by pressing the **Live View/Playback**  /  button.



The following table describes the information that is displayed in **Live View** when the camera settings are at their default values and an optional memory card is installed in the camera. If you change other camera settings, icons for those settings will also be displayed in **Live View**.



#	Icon	Description
1		<b>Live View</b> icon, indicating the camera is in <b>Live View</b> . This icon displays for the first few seconds.
2		Indicates that a memory card is installed in the camera
3		Power indicator, such as this full battery level indicator (see <b>Power Indicators</b> on page 116)
4	<b>12</b>	Remaining pictures count (actual number depends on the current <b>Image Quality</b> setting and how much space remains in memory)
5	<b>4MP</b>	<b>Image Quality</b> setting (default is <b>4MP</b> )

# Taking Still Pictures

To take a still picture:

1. Press the **Live View/Playback**  /  button until the **Live View**  icon appears in the upper left corner of the Image Display, then frame the subject for your picture in the Image Display.







2. Press the **Shutter** button to take the picture. The camera beeps after taking the picture.

**TIP:** Hold the camera with both hands and gently press the **Shutter** button to reduce camera shake and prevent blurry pictures.

After a picture is taken, the image appears for several seconds on the Image Display. This is called **Instant Review**. You can delete the image during **Instant Review** by pressing the ◀ button, then selecting **This Image** in the **Delete** sub-menu.

# Recording Video Clips

1. Press the **Live View/Playback**  /  button until the **Live View**  icon appears in the upper left corner of the Image Display, then frame the subject for your video using the Image Display.
2. To start recording video, press and release the **Video**  button on the top of the camera. A video  icon, **REC**, a video counter, and a message instructing how to end the video appear on the Image Display. The Self-Timer/Video light turns on solid red.
3. To stop recording video, press and release the **Video**  button again; otherwise, the video will continue recording until the camera runs out of memory.





After recording has stopped, the first frame of the video clip appears for three seconds on the Image Display. This is called **Instant Review**. You can delete the video clip during **Instant Review** by pressing the  button, then selecting **This Image** in the **Delete** sub-menu.

A video clip includes audio. To hear the audio portion of your video clips, transfer them to your computer and use the HP Image Zone software.

**NOTE:** Digital zoom is not available while recording video clips.

# Using Digital Zoom

You can use digital zoom whenever you want to capture only a portion of the scene in the Image Display. As you zoom in, a yellow frame surrounds the portion of the scene you want to capture, allowing you to eliminate unwanted portions of the scene.

1. While in **Live View**, press the **▲** button (**Zoom In**  icon) to enter digital zoom.
2. Continue to press **Zoom In**  until a yellow frame surrounds the area of the image you want to capture. If you zoom in too far and want to zoom out, press the **▼** button (**Zoom Out**  icon) to enlarge the selection.





The resolution number on the right side of the screen also becomes smaller as you digitally zoom. For example, **2.2MP** appears in place of **4MP**, indicating that the image is being reduced to a size of 2.2 Megapixels.





3. When the image is at the desired size, press the **Shutter** button to take the picture.
4. To turn digital zoom off, press the **▼** button (**Zoom Out**  icon) until the yellow frame disappears.

**NOTE:** Digital zoom reduces the resolution of an image, so your picture will tend to be more pixilated or grainy than images taken without zoom. In situations where you need higher quality (such as for printing), limit the use of digital zoom.

**NOTE:** Digital zoom is not available while recording video clips.

# Setting the Flash

The **Flash**  button allows you to cycle through the flash settings on the camera. To change the flash setting, press the **Flash**  button until the desired setting appears on the Image Display. The following table describes each of the flash settings on the camera.

Setting	Description
<b>Auto Flash</b> 	The camera measures the light level and uses the flash if necessary.
<b>Red-Eye</b> 	The camera measures the light level and uses the flash with red-eye reduction if necessary (for a description of red-eye reduction, see <b>Red Eye</b> on page 33).
<b>Flash On</b> 	The camera always uses flash. If the light is behind your subject, you can use this setting to increase the light on the front of your subject. This is called fill-flash.
<b>Flash Off</b> 	The camera will not use flash, no matter the lighting conditions. Use this setting to capture poorly lit subjects that are beyond the flash range. Exposure times may be increased when using this setting, so you should use a tripod to avoid blurry pictures from camera shake.

**NOTE:** The flash is not available in **Sunset** mode nor is it available while recording video clips.

If the flash setting is anything other than the default **Auto Flash** setting, the icon for the setting will appear in the **Live View** screen. The new setting remains in effect until it is changed again or until the camera is turned off. The flash setting resets to the default **Auto Flash** setting when you turn the camera off.





## Red Eye

The red-eye phenomenon is caused by light from the flash reflecting off the subjects' eyes, which sometimes makes a human's eyes appear red or an animal's eyes appear green or white in the captured image. When you use a flash setting with red-eye reduction, the camera flashes quickly up to three times to minimize the subject's pupils, thus reducing the effect of the red-eye phenomenon, before the camera uses the main flash. It will take longer to take a picture using red-eye reduction, because the shutter is delayed for the additional flashes. Therefore, make sure your subjects wait for the additional flashes.



# Using the Focus Modes

Focus modes change the focal distance of the camera to make it possible to take pictures of objects that are close to or far away from the camera.

To change the focus mode, slide the **Focus Mode** switch on the front of the camera. The following table describes both of the focus mode settings on the camera.

Setting	Description
<b>Normal</b> 	Use <b>Normal</b> mode when you need to take pictures of subjects more than 1 m (39 in) away.
<b>Macro</b> 	Use <b>Macro</b> mode to take close-up pictures of subjects less than 1 m (39 in) away. In this mode, the camera will focus at a distance range of 60 cm to 1m (24 to 39 in), and the Macro icon appears on the image display.

# Using the Self-Timer Settings

1. Secure the camera to a tripod or set it on a stable surface.
2. Press the **Timer**  button until **Self-Timer**  appears in the Image Display, then frame the subject (see page 27).
3. The next steps depend on whether you are capturing a still picture or recording a video clip.

## For Still Pictures:

Press the **Shutter** button. A countdown appears on the screen and the Self-Timer/Video light blinks for 10 seconds before the camera takes the picture.

## For Video Clips:

To start recording video, press the **Video**  button and then release it. A 10-second countdown appears on the Image Display. The Self-Timer/Video light on the front of the camera then blinks for 10 seconds before the camera starts recording the video.



To stop recording the video clip, press the **Video**  button again; otherwise, the video will continue recording until the camera runs out of memory.

The self-timer setting resets to the default **Normal** setting after the picture is taken or the video clip is recorded.



**TIP:** If you are taking still images in low light with or without a tripod, you can use the self-timer setting to avoid blurry images caused by camera shake. Place the camera on a steady surface or a tripod, frame your picture, then press the **Shutter** button all the way down and remove your hands from the camera. The camera will wait 10 seconds before taking the image, eliminating any possibility of your shaking the camera when you press the **Shutter** button.

# Using the Capture Menu

The **Capture Menu** allows you to adjust various camera settings that affect the characteristics of the images and video clips you capture with your camera.

1. To display the **Capture Menu**, press the  $\frac{\text{Menu}}{\text{OK}}$  button if **Live View** is on. If **Live View** is not on, press the **Live View/Playback**  /  button, and then press the  $\frac{\text{Menu}}{\text{OK}}$  button.



2. Use the  $\blacktriangle$   $\blacktriangledown$  buttons to scroll through the **Capture Menu** options.
3. Either press the  $\frac{\text{Menu}}{\text{OK}}$  button to select a highlighted option and display its sub-menu, or use the  $\blacktriangleleft$   $\blacktriangleright$  buttons to change the setting for the highlighted option without going to its sub-menu.
4. Within a sub-menu, use the  $\blacktriangle$   $\blacktriangledown$  buttons and then the  $\frac{\text{Menu}}{\text{OK}}$  button to change the setting for the **Capture Menu** option.
5. To exit the **Capture Menu**, press the **Live View/Playback**  /  button. For other ways to exit a menu, see **Camera Menus** on page 24.

# Shooting Modes

This setting provides a pre-defined set of camera settings that are optimized for taking still pictures of certain scene types to give you better results. In each shooting mode, the camera selects the best settings, such as the ISO speed, F-number (aperture), and shutter speed, optimizing them for the particular scene or situation.



**NOTE:** The shooting mode does not apply when you are recording video clips.

1. In the **Capture Menu** (page 37), select **Shooting Mode**.
2. In the **Shooting Mode** sub-menu, use the ▲▼ buttons to highlight a setting.
3. Press the  button to save the setting and return to the **Capture Menu**.



The following table explains the **Shooting Mode** settings in more detail:

Setting	Description
<b>Auto Mode</b>	Use <b>Auto Mode</b> when you need to take a good shot quickly, and do not have time to select a special shooting mode on the camera. <b>Auto Mode</b> works well for most shots in normal situations. The camera automatically selects the best F-number (aperture), ISO speed, and shutter speed for the scene.
 <b>Action</b>	Use <b>Action</b> mode to capture sporting events, moving cars, or any scene where you want to stop the action. The camera uses fast shutter speeds and higher ISO speeds to stop motion.

Setting	Description
<b>Landscape</b> 	Use <b>Landscape</b> mode to capture scenes with deep perspective, such as mountains or city skylines, when you want the foreground and the background to be in focus. The camera combines a higher F-number for better depth of field with higher saturation for a more vivid effect.
<b>Portrait</b> 	Use <b>Portrait</b> mode for pictures that have one or more people as their primary subject. The camera combines a smaller F-number to blur the background, with lower sharpness for a more natural effect.
<b>Sunset</b> 	Use <b>Sunset</b> mode to capture outdoor scenes at sunset. This mode starts the focus at infinity and sets the flash to <b>Flash Off</b> . This mode improves the saturation of sunset colors and retains the warmth of the scene with a bias towards the orange colors of the sunset.

If the shooting mode setting is anything other than the default **Auto Mode** setting, the icon for the setting will appear in the **Live View** screen. The new setting remains in effect until it is changed again or until the camera is turned off. The shooting mode setting resets to the default **Auto Mode** setting when you turn the camera off.

# Image Quality

This setting allows you to set the resolution and JPEG compression of the still images you capture with your camera. The **Image Quality** sub-menu has four settings.

1. In the **Capture Menu** (page 37), select **Image Quality**.
2. In the **Image Quality** sub-menu, use the ▲▼ buttons to highlight a setting.
3. Press the  $\frac{\text{Menu}}{\text{OK}}$  button to save the setting and return to the **Capture Menu**.



The following table explains the **Image Quality** settings in more detail:

Setting	Description
<b>4MP Best</b>	Images will be full resolution and have the lowest compression. This setting produces very high quality images and uses the most memory. This setting is recommended if you plan to print images up to 297 by 420 mm (11 by 17 in).
<b>4MP</b>	Images will be full resolution and have medium compression. This setting produces high quality images, but uses less memory than the <b>4MP Best</b> setting above. This is the default setting and is recommended if you plan to print images up to a size of 210 by 297 mm (8.5 by 11 in).



Setting	Description
<b>2MP</b>	Images will be half resolution and have medium quality and compression. This is a memory-efficient setting and is recommended if you plan to print images up to a size of 130 by 180 mm (5 by 7 in).
<b>VGA</b>	Images will be 640 by 480 (lowest) resolution and have medium compression. This is the most memory-efficient setting, but produces lower quality images. This setting is good for images you want to send via e-mail or post to the Internet.

The **Image Quality** setting affects both the quality of the images and the number of images that can be stored either in the camera's internal memory or on an optional memory card. For example, the **4MP Best** setting results in the highest quality images, but consumes more memory space than the next lower setting, **4MP**. Likewise, many more still images can be stored in memory at the **2MP** or **VGA** settings than at **4MP**; however, these settings result in lower quality images.

The **Pictures remaining** count at the bottom of the **Image Quality** sub-menu screen updates when you highlight each setting. See **Memory Capacity** on page 131 for more information about how the **Image Quality** setting affects the number of images that can be saved in the internal memory in the camera.

The **Image Quality** setting will appear in the **Live View** screen. The new setting remains in effect until it is changed again, even when you turn the camera off.

**NOTE:** When you use digital zoom, the resolution reduces as you zoom in. See **Using Digital Zoom** on page 31.

**NOTE:** **Image Quality** settings do not apply when recording video clips.

## Date & Time Imprint

This setting imprints either the date or the date and time of when the image was captured in the lower left-hand corner of the image. After you select either of the **Date & Time Imprint** settings, the date or date and time will be imprinted on all subsequent still images that are captured, not on previously captured images.



After you have taken a picture using either the **Date Only** or **Date & Time** setting, the date or date and time that is imprinted on the image cannot be removed later.

**TIP:** Verify that the date and time setting is correct before using this feature (see **Date & Time** on page 68).

1. In the **Capture Menu** (page 37), select **Date & Time Imprint**.
2. In the **Date & Time Imprint** sub-menu, use the ▲▼ buttons to highlight a setting.
3. Press the  $\frac{\text{Menu}}{\text{OK}}$  button to save the setting and return to the **Capture Menu**.



The following table explains the settings in more detail:

Setting	Description
<b>Off</b>	The camera will not imprint a date or date & time on the image.
<b>Date Only</b> 	The camera will permanently imprint the date in the lower left-hand corner of the image.
<b>Date &amp; Time</b> 	The camera will permanently imprint the date and time in the lower left-hand corner of the image.

If the new setting is anything other than the default **Off** setting, the icon for the setting will appear in the **Live View** screen. The new setting remains in effect until it is changed again, even when you turn the camera off.

**NOTE:** The **Date and Time** setting does not apply when recording video clips.

# EV Compensation

In difficult lighting conditions, you can use **EV** (Exposure Value) **Compensation** to override the automatic exposure setting that the camera makes.

**EV Compensation** is useful in scenes that contain many light objects (like a white object against a light background) or many dark objects (like a black object against a dark background). Scenes containing many light objects or many dark objects could turn out gray without the use of **EV Compensation**. For a scene with many light objects, increase the **EV Compensation** to a positive number to produce a brighter result. For a scene with many dark objects, decrease the **EV Compensation** to darken the scene to be closer to black.

1. In the **Capture Menu** (page 37), select **EV Compensation**.
2. In the **EV Compensation** sub-menu, use the ◀▶ buttons to change the EV setting in 0.33 steps from -2.0 to +2.0. The new setting is applied to the **Live View** screen behind the menu, so you can see the effect each setting will have on the picture.
3. Press the  button to save the setting and return to the **Capture Menu**.

If the setting is anything other than the default setting of **0.0**, the number value will appear in the **Live View** screen next to the  icon. The new setting remains in effect until it is changed again or until the camera is turned off. The **EV Compensation** setting resets to the default **0.0** setting when you turn the camera off.





# White Balance

Different kinds of lighting conditions cast different colors. For example, sunlight is more blue, while indoor tungsten light is more yellow. Scenes dominated by a single color may require an adjustment of the white balance setting to help the camera reproduce colors more accurately and ensure that whites appear white in the final image. You can also adjust the white balance to produce creative effects. For example, using the **Sun** setting can produce a warmer look to the image.

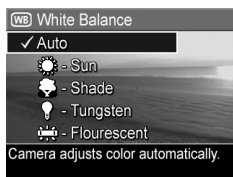

1. In the **Capture Menu** (page 37), select **White Balance**.



2. In the **White Balance** sub-menu, use the ▲▼ buttons to highlight a setting. The new setting is applied to the **Live View** screen behind the menu, so you can see the effect each setting will have on the picture.



3. Press the  button to save the setting and return to the **Capture Menu**.

The following table explains the settings in more detail:

Setting	Description
<b>Auto</b>	The camera automatically identifies and corrects for scene illuminance. This is the default setting.
<b>Sun</b> 	The camera balances color assuming the subject is outdoors under sunny or bright cloudy conditions.
<b>Shade</b> 	The camera balances color assuming the subject is outdoors in shade, in dark cloudy conditions, or at dusk.

Setting	Description
<b>Tungsten</b> 	The camera balances color based on incandescent or halogen lighting (typically found in homes).
<b>Fluorescent</b> 	The camera balances color based on fluorescent lighting.

If the setting is anything other than the default **Auto** setting, the icon for the setting will appear in the **Live View** screen. The new setting remains in effect until it is changed again or until the camera is turned off. The **White Balance** setting resets to the default **Auto** setting when you turn the camera off.

# ISO Speed

This setting adjusts the sensitivity of the camera to light. When **ISO Speed** is set to the default **Auto** setting, the camera selects the best ISO speed for the scene.

Lower ISO speeds will capture images with the least amount of grain (or noise), but result in slower shutter speeds. If taking a picture in low light conditions without a flash at **ISO 100**, you may want to use a tripod. In contrast, higher ISO numbers allow faster shutter speeds, and can be used when taking pictures in dark areas without a flash, or when taking pictures of fast moving objects. Higher ISO speeds produce pictures with more grain (or noise).

1. In the **Capture Menu** (page 37), select **ISO Speed**.
2. In the **ISO Speed** sub-menu, use the **▲▼** buttons to highlight a setting.
3. Press the **Menu**/**OK** button to save the setting and return to the **Capture Menu**.



If the setting is anything other than the default **Auto** setting, the icon for the setting (as shown in the **ISO Speed** sub-menu) will appear in the **Live View** screen. The new setting remains in effect until it is changed again or until the camera is turned off. The **ISO Speed** setting resets to the default **Auto** setting when you turn the camera off.

**NOTE:** The **ISO Speed** setting does not apply when recording video clips.











---

## 3 Reviewing Images and Video Clips



You can use **Playback** to review the images and video clips stored in your camera.

In addition, the **Playback Menu** allows you to view thumbnails of images or magnify images so you can take a closer look at them on the camera, delete images or video clips, and manipulate images. To do these things and more, see **Using the Playback Menu** on page 53.

### Using Playback

1. Press the **Live View/Playback**  /  button until the **Playback**  icon appears in the upper left corner of the Image Display.
2. Use the   buttons to scroll through your images and video clips. Press and hold either of the   buttons to scroll faster.





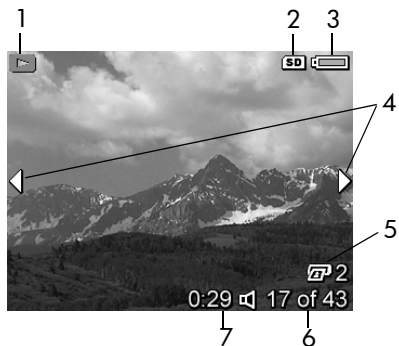

For video clips, indicated by the video  icon, you see only the first frame for the first 2 seconds. They then begin playing automatically.

3. To change to **Live View** after reviewing your images and video clips, press the **Live View/Playback**  /  button again.



**NOTE:** To hear audio clips that have been attached to your still images, transfer them to your computer and use the HP Image Zone software.

During **Playback**, the Image Display also indicates additional information about each image or video clip. The following table describes this information.



#	Icon	Description
1		<b>Playback</b> icon, indicating the camera is in <b>Playback</b> . This icon displays for the first few seconds.
2		Displays only when an optional memory card is installed in the camera.
3		Power indicator, such as this full battery level indicator (see <b>Power Indicators</b> on page 116).
4		Displays for the first few seconds when you enter <b>Playback</b> to indicate that you can scroll through the images or video clips using the ◀▶ buttons.
5	 <b>2</b>	Indicates this image has been selected for printing 2 copies (see <b>Print</b> on page 58).
6	<b>17 of 43</b>	Shows the number of this image or video clip out of the total number of images and video clips that are stored in memory.
7	<b>0:29</b>  or 	<ul style="list-style-type: none"> <li>Shows the recorded length of this audio or video clip.</li> <li>Indicates this image has an audio clip attached.</li> <li>Indicates this is a video clip.</li> </ul>





# Total Images Summary Screen

When you press the ► button while viewing the last image, the **Total Images Summary** screen appears showing the number of pictures taken, and the number of pictures remaining. A counter indicating the total number of images selected for printing  is shown in the upper left-hand corner of the screen. In addition, icons are shown in the upper right-hand corner of the screen for an optional memory card if installed (indicated by the **SD** icon ) and the power indicator (see **Power Indicators** on page 116).



# Using the Playback Menu

The **Playback Menu** allows you to delete still images or video clips, undelete images, and format the camera's internal memory or optional memory card. Additionally, you can record audio clips to attach to an image, view thumbnails, magnify and rotate images, and select images for printing.

1. To display the **Playback Menu**, press the  $\frac{\text{Menu}}{\text{OK}}$  button while you are in **Playback**. If you are not currently in **Playback**, press the **Live View/Playback**  /  button until you are in **Playback**, then press the  $\frac{\text{Menu}}{\text{OK}}$  button.
2. Use the  $\blacktriangle$ / $\blacktriangledown$  buttons to highlight the **Playback Menu** option that you want to use on the left side of the Image Display. The **Playback Menu** options are explained later in this section.
3. Move to the image or video clip you want to use by pressing the  $\blacktriangleleft$ / $\blacktriangleright$  buttons. This makes it easy to perform the same action on several images or video clips, such as deleting multiple images or video clips.
4. Select the highlighted **Playback Menu** option by pressing the  $\frac{\text{Menu}}{\text{OK}}$  button. Follow the instructions on the screen to complete the selected task.
5. To exit the **Playback Menu**, press the **Live View/Playback**  /  button. For other ways to exit a menu, see **Camera Menus** on page 24.

The following table summarizes the **Playback Menu** options.

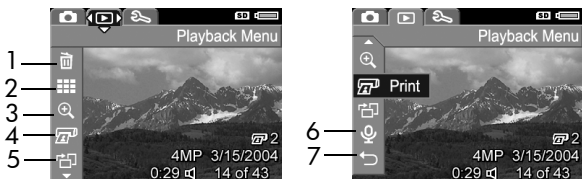

#	Icon	Description
1		<b>Delete</b> —Presents a sub-menu where you can delete the current image or video clip, delete all images and video clips, format the internal memory or an optional memory card, and undelete the last deleted image. (See <b>Delete</b> on page 55.)
2		<b>View Thumbnails</b> —Displays a thumbnail view of images and video clip frames on the Image Display. (See <b>Viewing Thumbnails</b> on page 56.)
3		<b>Magnify</b> —Magnifies the currently displayed image. (See <b>Magnifying Images</b> on page 57.)
4		<b>Print</b> —Allows you to specify the number of copies of the currently displayed image to print when connected to a computer or printer. (See <b>Print</b> on page 58.)
5		<b>Rotate</b> —Rotates the currently displayed still image in 90 degree increments. (See <b>Rotate</b> on page 59.)
6		<b>Record Audio</b> —Records an audio clip to attach to this still image. (See <b>Record Audio</b> on page 60.)
7		<b>EXIT</b> —Exits the <b>Playback Menu</b> .

# Delete

In the **Playback Menu** (page 53), when you select **Delete**, the **Delete** sub-menu displays. Use the ▲▼ buttons to highlight an option, and then press the  button to select it.

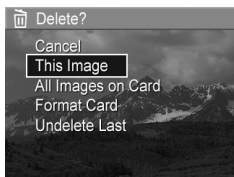

The **Delete** sub-menu provides the following options:

- **Cancel**—Returns you to the **Playback Menu** without deleting the currently displayed image or video clip.
- **This Image**—Deletes the currently displayed image or video clip.
- **All Images (in Memory/on Card)**—Deletes all of the images and video clips either in internal memory, or on an optional memory card that is installed in the camera.
- **Format (Memory/Card)**—Deletes all of the images, video clips, and files in internal memory or on an optional memory card, and then formats the internal memory or memory card. To help prevent corrupted cards and images, use **Format Card** to format optional memory cards before you use them for the first time, and when you want to delete all of the images and video clips stored on them.
- **Undelete Last**—Recovers the most recently deleted image. (This option is only displayed after a **Delete** operation has been performed.) You can recover only the most recently deleted image. Once you proceed to another operation, for example, powering off the camera or taking another picture, the delete operation you performed is permanent, and the image is no longer recoverable.

# Viewing Thumbnails

In the **Playback Menu** (page 53), when you select **View Thumbnails** you can view the still images you have taken and the first frames of the video clips you have recorded arranged in a matrix of nine thumbnail images and video clip frames per screen.

1. In the **Playback Menu**, select **View Thumbnails**. A **Thumbnail** view of up to nine images and video clip frames appears on the Image Display. A yellow border surrounds the current image or video clip frame.

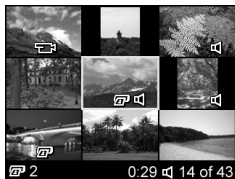

2. Use the ◀▶ buttons to scroll horizontally to the previous or next thumbnail.
3. Use the ▲▼ buttons to scroll vertically to the thumbnail directly above or below the current thumbnail.
4. Press the  $\frac{\text{Menu}}{\text{OK}}$  button to exit **Thumbnail** view and return to **Playback**. The current image or video clip (that was in the yellow border in **Thumbnail** view) is displayed in full view on the Image Display again.

At the bottom of the Image Display, a print icon indicates that the current image has been selected for printing, an audio icon signifies that an audio clip is attached to this still image, and a video icon signifies that the image is a video clip.



# Magnifying Images

In the **Playback Menu** (page 53), when you select **Magnify**, the currently displayed image is automatically magnified 2x. The center portion of the magnified image is displayed.

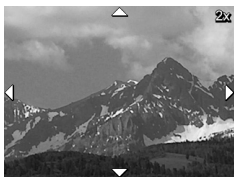

1. In the **Playback Menu**, select **Magnify**.
2. To pan around the magnified image, use the ◀▶ and ▲▼ buttons.
3. To increase magnification to 4x, press the  $\frac{\text{Menu}}{\text{OK}}$  button. Press the  $\frac{\text{Menu}}{\text{OK}}$  button again to return to normal magnification.
4. Press the  $\frac{\text{Menu}}{\text{OK}}$  button to exit **Magnify** and return to **Playback**.

**NOTE:** You can only magnify still images; video clips cannot be magnified.

# Print

In the **Playback Menu** (page 53), when you select **Print**, the camera displays a sub-menu that allows you to select a still image for printing.

1. In the **Playback Menu**, select **Print**. The Print selection screen appears on the Image Display with the number of copies to print displayed in the center of the screen.

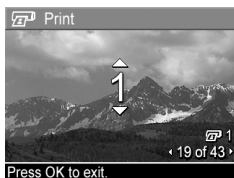

2. Use the ▲▼ buttons to increase or decrease the number of copies to print.
3. Use the ◀▶ buttons to select additional images to print.
4. After you have selected the images to be printed, press the  $\frac{\text{Menu}}{\text{OK}}$  button to return to the Playback Menu.

Images selected for printing will be printed when you connect your camera to a PictBridge-certified printer (see **Printing Images Directly from the Camera** on page 62) or a computer with the HP Image Zone software installed (see **HP Image Zone Software** on page 75).

**NOTE:** **Print** is not available for video clips.

# Rotate

In the **Playback Menu** (page 53), when you select **Rotate**, the camera displays a sub-menu that allows you to rotate the image in 90-degree increments.

1. In the **Playback Menu**, select **Rotate**.
2. Use the ◀▶ buttons to rotate the image clockwise or counter-clockwise. The image rotates in the Image Display.
3. After you have rotated the image to the desired orientation, press the  $\frac{\text{Menu}}{\text{OK}}$  button to save image in the new orientation.

**NOTE:** **Rotate** is not available for video clips.

# Record Audio

In the **Playback Menu** (page 53), when you select **Record Audio**, you can attach an audio clip to a still picture you have already taken, or you can replace an audio clip already attached to an image.

1. In the **Playback Menu**, select **Record Audio**. Audio recording starts immediately.
2. To stop recording, press the  $\frac{\text{Menu}}{\text{OK}}$  button; otherwise, the audio continues to record until the camera runs out of memory.

If the currently displayed image already has an audio clip attached to it, the **Record Audio** sub-menu is displayed when you select **Record Audio**. This sub-menu lists these options:

- **Keep Current Clip**—Retains the current audio clip and returns to the **Playback Menu**.
- **Record New Clip**—Begins to record audio, replacing the previous audio clip.
- **Delete Clip**—Deletes the current audio clip and returns to the **Playback Menu**.

**TIP:** To hear audio clips, transfer the images to which they are attached to your computer and use the HP Image Zone software.

**NOTE:** **Record Audio** is not available for video clips.

---

## 4 Transferring and Printing Images

### Transferring Images to a Computer

**TIP:** You can also perform this task using a memory card reader (see **Using a Memory Card Reader** on page 78).

1. Confirm that either the HP Image Zone software or the HP Image Zone Express (Windows only) software is installed on your computer (see **Install the Software** on page 17). To transfer images to a computer that does not have the HP Image Zone software installed on it, see **Using Your Camera without Installing the HP Image Zone Software** on page 77.
2. Your camera came with a special USB cable for connecting the camera to a computer. Connect the larger end of that USB cable to the computer.
3. Open the door on the side of the camera nearest the lens and connect the smaller end of the USB cable to the USB connector on the camera.



#### 4. Turn on the camera.

- **On Windows:** The HP Image Transfer software provides the download functionality. In the **Transfer Images from Camera/Card** screen, click **Start Transfer**. The images are transferred to the computer. When the **Image Action Summary** screen appears on the computer, you can disconnect the camera from the computer.
- **On Macintosh:** Image Capture or iPhoto provides the download functionality. When the download is complete, you can disconnect the camera from the computer.

## Printing Images Directly from the Camera

You can connect the camera directly to any PictBridge-certified printer to print images. To determine if your printer is PictBridge-certified, look for the PictBridge logo on your printer.



1. Check that the printer is turned on. There should be no blinking lights on the printer or error messages displayed about the printer. Load paper into the printer, if needed.
2. Connect your camera to the printer.
  - a. Make sure the camera's **USB Configuration** setting is set to **Digital Camera** (see **USB Configuration** on page 69).

b. Using the USB cable that came with your camera, connect the larger, flat end of the USB cable to the corresponding connector on the PictBridge-certified printer.



**TIP:** The PictBridge connector is usually located on the front of the printer.

3. Open the door on the side of the camera nearest the lens and connect the small end of the USB cable to the USB connector on the camera.
4. When the camera is connected to the printer, a **Print Setup** menu displays on the camera. If you already selected images to print using the camera **Playback Menu**, the number of images selected is shown. Otherwise, **Images: ALL** is displayed.
5. To change the settings in the **Print Setup** menu, use the ▲▼ buttons on the camera to select a menu option, then use the ◀▶ buttons on the camera to change the setting.
6. When the settings are correct, press the  $\frac{\text{Menu}}{\text{OK}}$  button on the camera to begin printing.



After connecting the camera to the printer, you can print the images you have selected for printing or all images in the camera.

**TIP:** Printing directly from the camera has the following limitation:  
Video clips cannot be printed directly from the camera. See your printer's manual for more information.  
To avoid this limitation, use the HP Image Zone software (see **HP Image Zone Software** on page 75).

**NOTE:** If you connect the camera to a non-HP printer and encounter problems with printing, contact your printer manufacturer. HP does not provide customer support for non-HP printers.



In addition to the method described in this section, you can also print images directly from the printer using the following method:

- If you have an optional memory card that has images or video clips stored on it that you want to print and your printer has a memory card slot, remove the optional memory card from the camera and insert it into the printer's memory card slot to print the images or video clips. If your printer can print video clips, you can insert the memory card directly in the printer's memory card slot and print the video clip. See your printer's manual for specific instructions.





# 5 Using the Setup Menu

The **Setup Menu** allows you to adjust a number of camera settings, such as the camera sounds, date and time, and the configuration of the USB.

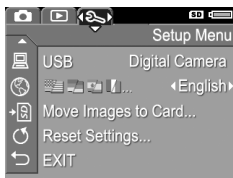
1. While in **Live View**, press the **Live View/Playback**  /  button, and then press the  $\frac{\text{Menu}}{\text{OK}}$  button.
2. Scroll to the **Setup Menu**  tab using the  $\blacktriangleleft$   $\blacktriangleright$  buttons.



3. Use the  $\blacktriangle$   $\blacktriangledown$  buttons to scroll through the **Setup Menu** options.
4. Either press the  $\frac{\text{Menu}}{\text{OK}}$  button to select a highlighted option and display its sub-menu, or use the  $\blacktriangleleft$   $\blacktriangleright$  buttons to change the setting for the highlighted option without going to its sub-menu.
5. Within a sub-menu, use the  $\blacktriangle$   $\blacktriangledown$  buttons and then the  $\frac{\text{Menu}}{\text{OK}}$  button to change the setting for the **Setup Menu** option.
6. To exit the **Setup Menu**, press the **Live View/Playback**  /  button. For other ways to exit a menu, see **Camera Menus** on page 24.

# Display Brightness

This setting allows you to adjust the brightness of the Image Display for the viewing conditions. You can use this setting to increase the brightness for harsh lighting environments, or reduce the brightness to extend battery life.

The default **Display Brightness** setting is **Medium**.

1. In the **Setup Menu** (page 65), select **Display Brightness**.

2. In the **Display Brightness** sub-menu, highlight the brightness level you prefer for the Image Display. The new setting is applied to the **Live View** screen behind the menu so you can see the effect the setting will have on the display brightness.



3. Press the  $\frac{\text{Menu}}{\text{OK}}$  button to save the setting and return to the **Setup Menu**.

The new setting remains in effect until it is changed again, even when you turn the camera off.

# Camera Sounds

Camera sounds are the sounds that the camera makes when you turn it on, press a button, or take a picture. Camera sounds are not the audio sounds recorded with images or video clips.

The default **Camera Sounds** setting is **On**.

1. In the **Setup Menu** (page 65), select **Camera Sounds**.
2. In the **Camera Sounds** sub-menu, highlight **Off** or **On**.
3. Press the  $\frac{\text{Menu}}{\text{OK}}$  button to save the setting and return to the **Setup Menu**.

The new setting remains in effect until it is changed again, even when you turn the camera off.

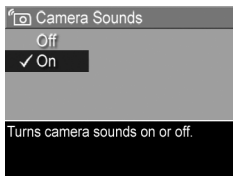

# Date & Time

This setting allows you to set the date/time format, as well as the current date and time for the camera. This is usually done when you first set up the camera; however, you may need to re-set the date and time when you are travelling to different time zones, after the camera has been without power for an extended time, or if the date or time is incorrect.

The date/time format chosen will be used to display the date information in **Playback**. Also, the format chosen in this setting is what is used in the **Date & Time Imprint** feature (see **Date & Time Imprint** on page 42).

1. In the **Setup Menu** (page 65), select **Date & Time**.
2. In the **Date & Time** sub-menu, adjust the value of the highlighted selection by using the ▲▼ buttons.
3. Press the ◀▶ buttons to move to the other selections.
4. Repeat Steps 2 and 3 until the correct date/time format, date, and time are set.
5. Press the  button to save the setting and return to the **Setup Menu**.

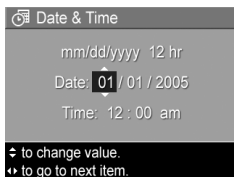

The date/time format setting remains in effect until it is changed again, even when you turn the camera off. The date and time settings also remain current as long as the camera batteries that are installed have a charge, or the batteries are removed for less than 10 minutes.

If the camera is without batteries for a prolonged period, the clock may be reset to the last date and time at which the

camera was turned off. You may be prompted to update the date and time the next time you power on the camera.

## USB Configuration

This setting determines how the camera is recognized when connected to a computer.

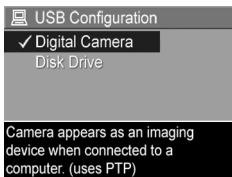

1. In the **Setup Menu** (page 65), select **USB**.
2. In the **USB Configuration** sub-menu, highlight one of these two choices:
  - **Digital Camera**—Causes the computer to recognize the camera as a digital camera using the Picture Transfer Protocol (PTP) standard. This is the default setting on the camera, and the setting needed to configure the camera for printing to a PictBridge-certified printer.
  - **Disk Drive**—Causes the computer to recognize the camera as a disk drive using the Mass Storage Device Class (MSDC) standard. Use this setting to transfer images to a Windows 2000, 98SE, or Me computer that does not have the HP Image Zone software installed on it (see **Transferring Images to a Computer without HP Image Zone Software** on page 77). You may be unable to use this setting with a Windows 98 computer that does not have the HP Image Zone software installed on it.
3. Press the  button to save the setting and return to the **Setup Menu**.



The new setting remains in effect until it is changed again, even when you turn the camera off.

# Language

This setting allows you to set the language used in the camera interface, such as the text in menus.

1. In the **Setup Menu** (page 65), select .
2. In the **Language** sub-menu, use the ▲▼ and ◀▶ buttons to highlight the language you want to use.
3. Press the  button to save the setting and return to the **Setup Menu**.



The new setting remains in effect until it is changed again, even when you turn the camera off.

# Move Images to Card

This option allows you to move images from the internal memory to an optional memory card that you have installed (see **Install and Format a Memory Card (Optional)** on page 15). This option is available in the **Setup Menu** if an optional memory card is installed in the camera and the internal memory contains at least one image.

1. In the **Setup Menu** (page 65), highlight **Move Images to Card...** and press the  $\frac{\text{Menu}}{\text{OK}}$  button.
2. A confirmation screen appears in the Image Display.
  - If there is room on the memory card for all the images in internal memory, the confirmation screen asks if you want to move all the images.
  - If only some of the images will fit, the confirmation screen tells you how many images it can move and asks if you want to move them.
  - If no images can be moved to the memory card, the confirmation screen displays **CARD FULL**.
3. To move the images, highlight **Yes** and press the  $\frac{\text{Menu}}{\text{OK}}$  button.

During the move, a progress bar is shown. All of the images that are successfully moved to the memory card are then deleted from the camera's internal memory. When the move is complete, you return to the **Setup Menu**.

# Reset Settings

This option allows you to reset the camera to the factory default settings.

1. If you have an optional memory card in the camera, remove the memory card (see page 16).
2. In the **Setup Menu** (page 65), select **Reset Settings....**
3. In the **Reset All Settings?** sub-menu, highlight one of these two choices:
  - **Cancel**—Exits the menu without resetting any of the settings.
  - **Yes**—Resets all camera settings to their default value in the **Capture Menu** and **Setup Menu** (except **Date & Time, Language, and USB Configuration**).
4. Press the  $\frac{\text{Menu}}{\text{OK}}$  button to reset settings and return to the **Setup Menu**.
5. If you removed an optional memory card in Step 1, replace the memory card.



---

# 6 Troubleshooting and Support

This chapter contains information on the following topics:

- Resetting the camera (page 74)
- HP Image Zone software, including system requirements and HP Image Zone Express (page 75)
- Using the camera without installing the HP Image Zone software (page 77)
- Possible problems, causes, and solutions (page 83)
- Error messages on the camera (page 95)
- Error messages on the computer (page 104)
- Getting assistance from HP, including web and phone support (page 106)

**NOTE:** For more information about solutions to problems mentioned here, as well as any other issues you might have with your camera or the HP Image Zone software, see the HP Customer Support website:

**[www.hp.com/support](http://www.hp.com/support)**.

# Resetting the Camera

If your camera does not respond when you press any buttons, try resetting the camera as follows:

1. Turn off the camera.
2. If you have an optional memory card installed, remove it. (Although removing an optional memory card is not necessary for performing the reset, it eliminates the memory card as a possible cause of the problem.)
3. Remove the batteries from the camera for 5 to 10 seconds.
4. Reinsert the batteries and close the Battery/Memory card door.
5. After verifying that the camera works without an optional memory card, turn off the camera and reinsert the card if you have one.

# HP Image Zone Software

The HP Image Zone software provides several features that enhance your camera's capabilities. With the full version of the HP Image Zone software, you can use **HP Instant Share** to e-mail your photos without sending large file attachments. You can also create online albums or order professionally processed prints directly from your computer.

If your computer uses the Windows operating system, the HP Image Zone software installation process (see **Install the Software** on page 17) automatically installs either the full version of the HP Image Zone software, the HP Image Zone Express version, or no HP Image Zone software. This depends on your computer's system configuration, as explained in the next section. HP Image Zone Express lacks some features contained in the full version of HP Image Zone. See **HP Image Zone Express (Windows Only)** on page 76.

## System Requirements (Windows Only)

**NOTE:** The system requirements in this section apply only to computers using the Windows operating system.

Depending on your computer's system configuration, the installation process installs either the full version of the HP Image Zone software, the HP Image Zone Express version, or no HP Image Zone software.

- If your computer has Windows 2000 or XP and 128MB of RAM or more, the installation process installs the full version of the HP Image Zone software.
- If your computer has Windows 2000 or XP and between 64MB and 128MB of RAM, the installation process

installs the HP Image Zone Express software. See **HP Image Zone Express (Windows Only)** on page 76.

- If your computer has Windows 98, 98 SE, or Me and at least 64MB of RAM, the installation process installs the HP Image Zone Express software.
- If your computer has less than 64MB of RAM, you cannot install the HP Image Zone software. See **Using Your Camera without Installing the HP Image Zone Software** on page 77.

## HP Image Zone Express (Windows Only)

HP Image Zone Express has most of the features of the full version of the HP Image Zone software, including transferring images and video clips from your camera to a computer. However, you will not be able to view transferred video clips in Image Zone Express: you must view them with another viewer software package.

# Using Your Camera without Installing the HP Image Zone Software

You can still transfer images and video clips from the camera to your computer without installing either HP Image Zone or HP Image Zone Express. However, the process for transferring will be different, since normally the HP Image Zone software handles this task. See the following section for details.

## Transferring Images to a Computer without HP Image Zone Software

If you do not, or cannot, install HP Image Zone on your computer, there are three ways to transfer images from your camera to the computer:

- Connect your camera to the computer as a Digital Camera (Windows XP or Mac OS X only)
- Use a memory card reader
- Configure the camera as a disk drive

## Connecting Your Camera as a Digital Camera

If you have a Windows XP system, or a Mac OS X system, simply connect the camera to your computer directly, and the operating system will launch a program to help you transfer images. Check that your camera **USB Configuration** in the **Setup Menu** is set to **Digital Camera**, and connect the camera to your computer with the USB cable.

## Using a Memory Card Reader

If you are using a memory card in your camera, you can simply remove it from the camera and put it in a memory card reader (purchased separately). The memory card reader acts just like a floppy disk drive or CD-ROM drive. In addition, some computers and HP Photosmart printers have memory card slots built into them, and you can use these memory card slots as you would use a regular memory card reader to save images to the computer.

### Transferring Images to a Windows Computer Using a Memory Card Reader

1. Remove the memory card from your camera and insert it into the memory card reader (or the memory card slot in your computer or printer).
2. Right-click on the **My Computer** icon on your desktop, then select **Explore** from the menu.
3. A screen appears that shows a list of disk drives under **My Computer**. The memory card shows up as a removable disk drive. Click on the + sign just to the left of the removable disk.
4. Two directories (folders) appear under the removable disk. Click on the + sign next to the folder called **DCIM**, and a subdirectory for your camera should appear. When you click on the subdirectory under **DCIM**, the list of your images should appear on the right side of the Explorer screen.

**NOTE:** You may have more than one folder in your **DCIM** directory. If you cannot locate the images, check all the folders in the **DCIM** directory.

5. Select all the images (in the **Edit** pull-down menu click on **Select All**), then copy them (in the **Edit** menu click on **Copy**).
6. Click on the **Local Disk** under **My Computer**. You are now working in your computer's hard disk drive.
7. Create a new folder under **Local Disk** (go to the **File** pull-down menu and click on **New**, then click on **Folder**. A folder called **New Folder** appears in the right side of the Explorer screen). While the text of this new folder is highlighted, you can type in a new name (for example, **Pictures**). To change the name of the folder later, you can simply right-click on the folder name, choose **Rename** from the menu that appears, then type in the new name.
8. Click on the new folder you just created, then go to the **Edit** pull-down menu and click on **Paste**.
9. The images you copied in Step 5 are pasted into this new folder on your computer's hard drive. To verify that the images were successfully transferred from the memory card, click on the new folder. You should see the same list of files in that folder that you saw when you looked at them on the memory card (Step 4).
10. When you have verified that the images were successfully transferred from the memory card to your computer, put the card back in your camera. To free up space on the card, you can either delete the images or format the card (under the **Delete** option in the **Playback Menu** in the camera).

**NOTE:** It is recommended that you format the card rather than delete the images because it will help prevent corrupted images or cards.

## Transferring Images to a Macintosh Computer Using a Memory Card Reader







1. Remove the memory card from your camera and insert it into the memory card reader (or the memory card slot in your computer or printer).
2. Depending on your computer configuration and/or the version of the Mac OS you are running, an application called either Image Capture or iPhoto will launch automatically and guide you through the process of transferring images from your camera to your computer.
  - If the Image Capture application is launched, click on either the **Download Some** or **Download All** button to transfer the images to your computer. By default, the images will be put in the **Pictures** or **Movies** folder (depending on which kind of file they are).
  - If the iPhoto application is launched, click on the **Import** button to transfer the images to your computer. The images will be stored in the iPhoto application, so to access the images later, simply run iPhoto.
  - If no application launches automatically or if you want to copy the images manually, look on the desktop for a disk drive icon which represents the memory card, then copy the images from there to your local hard drive. For more information about how to copy files, visit Mac Help, the help system included with your computer.



## Configuring the Camera as a Disk Drive

You can set up your camera to function as a disk drive when it is connected to your computer, so you can transfer images without using the HP Image Zone software.



**NOTE:** Recommended for Windows 2000, Me, and 98 SE computers. You may be unable to use this method with Windows 98 computers.

1. Set your camera to act as a **Disk Drive** (you only need to do this step once):
  - a. Turn the camera on, press the  button, then use the  button to navigate to the **Setup Menu** .
  - b. Use the  button to highlight the **USB** menu option, then use the  button to select **Disk Drive**.
  - c. Press the **Live View/Playback**  /  button to exit the **Setup Menu**.
2. Connect the camera to your computer using the USB cable.
3. At this point, the process is the same as described in **Using a Memory Card Reader** on pages 78, 80. On Windows computers, the camera will appear as a removable disk in the Windows Explorer screen. On Macintosh computers, either the Image Capture or iPhoto application will launch automatically.
4. When you have finished transferring images from the camera to the computer, simply disconnect the camera from the computer. If your computer is running Windows 2000 or XP and you get an **Unsafe Removal** warning, disregard the warning.

**NOTE:** On Macintosh computers, if either Image Capture or iPhoto do not launch automatically, look on the desktop for a disk drive icon with your camera's model number. For more information about how to copy files, visit Mac Help.

# Problems and Solutions







Problem	Possible Cause	Solution
<b>The camera does not turn on.</b>	You did not slide the lens cover far enough.	<ul style="list-style-type: none"><li>• Slide the lens cover until it clicks.</li></ul>
	The batteries are functioning incorrectly, are dead, are installed incorrectly, are missing, or are the wrong type.	<ul style="list-style-type: none"><li>• The charge in the batteries could be low or completely drained. Try installing new or recharged batteries.</li><li>• Ensure that the batteries are installed correctly (see page 11).</li><li>• Do not use ordinary Alkaline batteries. For best results, use Energizer Lithium AA or rechargeable NiMH AA batteries.</li></ul>

<b>Problem</b>	<b>Possible Cause</b>	<b>Solution</b>
<b>The camera does not turn on</b> (continued).	The optional memory card is not a supported card or is corrupted.	Ensure that the memory card is the proper type for your camera (see page 129). If the card is the proper type, remove the memory card and see if you can turn on the camera. If you can turn on the camera with the memory card removed, then the card is probably corrupted. Format the memory card with a computer and a card reader. If the camera still does not turn on, replace the memory card.
	The camera has stopped operating.	Reset the camera (see page 74).
<b>The Power/Memory light is on but the Image Display is off.</b>	The Image Display has shut down after one minute of inactivity.	Press the <b>Live View/Playback</b>  /  button to re-activate the Image Display.
	The camera may have experienced a transient problem.	Reset the camera (see page 74).
<b>The Power/Memory light is on but the camera seems stuck and won't operate properly.</b>	The camera may have experienced a transient problem.	Reset the camera (see page 74).

<b>Problem</b>	<b>Possible Cause</b>	<b>Solution</b>
<b>I have to replace or recharge the batteries frequently.</b>	Extended Image Display use for video recording, excessive flash use, or <b>Display Brightness</b> set to <b>High</b> , increases the rate of battery drain.	See <b>Extending Battery Life</b> on page 112.
	The NiMH batteries you are using were recharged incorrectly, or have drained on their own because they have not been used lately.	NiMH batteries are not fully charged when new, and they discharge over time whether or not they are installed in a camera. Batteries that are new or have not been charged recently must be recharged to reach full capacity (see page 117).
	Battery chemistry type is inappropriate for the way the camera is being used.	See <b>Performance per Battery Type</b> on page 114.
<b>The camera does not respond when I press a button.</b>	The camera is turned off or has shut down.	Turn on the camera, or turn it off and then on again.
	The batteries are drained.	Replace or recharge the batteries.



<b>Problem</b>	<b>Possible Cause</b>	<b>Solution</b>
<b>The camera does not respond when I press a button</b> (continued).	The camera is connected to a computer.	Most of the camera buttons do not respond when the camera is connected to a computer. If they respond, it is only to turn the Image Display on if it is off, or, in some cases, turn the Image Display off if it is on.
	The camera is processing an image.	Wait until the Power/Memory light turns solid green, indicating the camera has completed processing the previously taken image.
	The optional memory card is not a supported card or is corrupted.	Ensure that the memory card is the proper type for your camera (see page 129). If the card is the proper type, turn off the camera, remove the memory card, and turn on the camera. If the camera responds when you press a button, then the card is probably corrupted. Replace the memory card.
	The camera has stopped operating.	Reset the camera (see page 74).
<b>A long delay occurs between pressing the Shutter button and the camera taking a picture.</b>	The scene is dark and the camera is taking a long exposure.	<ul style="list-style-type: none"> <li>• Use the flash.</li> <li>• If using flash is not possible, then use a tripod to keep the camera steady during the long exposure time.</li> </ul>

<b>Problem</b>	<b>Possible Cause</b>	<b>Solution</b>
<b>A long delay occurs between pressing the Shutter button and the camera taking a picture</b> (continued).	The camera is using a flash setting with red-eye reduction.	It will take longer to take a picture with red-eye reduction. The shutter is delayed because of the additional flashes. In turn, make sure your subjects wait for the additional flashes.
<b>The camera does not take a picture when I press the Shutter button.</b>	You did not press the <b>Shutter</b> button hard enough.	Press the <b>Shutter</b> button all the way down.
	The internal memory or the optional memory card that is installed is full.	Transfer images from the camera to your computer, then format the internal memory or the memory card (page 15 and 55). Or replace the card with a new one.
	The optional memory card that is installed is locked.	With the camera turned off, remove the memory card and switch the locking tab on the card to the unlocked position.
	The flash is recharging.	Wait until the flash has recharged before taking another picture.
	The camera is still saving the last picture you took.	Wait a few seconds for the camera to finish processing the last image before taking another picture.

Problem	Possible Cause	Solution
<b>My image is blurry.</b>	The light is low and the flash is set to <b>Flash Off</b>  .	<ul style="list-style-type: none"> <li>In dim light, the camera requires a longer exposure, and it is difficult to hold the camera steady for more than 1/60 of a second. Use a tripod to hold the camera steady, improve lighting conditions, or set the flash to <b>Auto Flash</b>  (see page 32).</li> <li>Hold the camera with two hands as you gently press the <b>Shutter</b> button.</li> </ul>
	The subject was close to the camera, so the camera should have been set to the <b>Macro</b>  focus mode.	Set the camera to the <b>Macro</b>  , focus mode and try taking the picture again (see page 34).
	The subject moved or you moved the camera while you took the picture.	<ul style="list-style-type: none"> <li>Set the flash to <b>Auto Flash</b>  or <b>Flash On</b>  and set the shooting mode to <b>Action</b> .</li> <li>Hold the camera with two hands as you press the <b>Shutter</b> button or use a tripod.</li> </ul>



Problem	Possible Cause	Solution
<b>My image is too bright.</b>	The flash provided too much light.	<ul style="list-style-type: none"> <li>• Turn the flash off (see page 32).</li> <li>• Move back from the subject.</li> </ul>
	You used <b>EV Compensation</b> when you should not have.	Set <b>EV Compensation</b> to 0.0 (see page 44).
	A natural or artificial source other than the flash provided too much light.	<ul style="list-style-type: none"> <li>• Try taking the picture from a different angle.</li> <li>• Avoid pointing the camera directly toward a bright light or reflective surface on a sunny day.</li> <li>• Decrease <b>EV Compensation</b> (see page 44).</li> </ul>
	The scene had many dark objects, such as a black object on a dark background.	Decrease the <b>EV Compensation</b> (see page 44).
	The Display Brightness needs to be adjusted.	Set the <b>Display Brightness</b> in the <b>Setup Menu</b> to <b>Low</b> or <b>Medium</b> (see page 66).

Problem	Possible Cause	Solution
<b>My image is too dark.</b>	The flash was on, but the subject was too far away.	Make sure your subject is within the flash working distance (see page 127). If not, try using the <b>Flash Off</b>  setting (see page 32). This setting will require a longer exposure, so use a tripod.
	The scene had many light-colored objects, such as a white object on a light background.	Increase the <b>EV Compensation</b> (see page 44).
	There was not enough light.	<ul style="list-style-type: none"> <li>• Wait for natural lighting conditions to improve.</li> <li>• Add indirect lighting.</li> <li>• Use the flash (see page 32).</li> <li>• Increase the <b>EV Compensation</b> (see page 44).</li> </ul>
	A light is behind the subject.	<ul style="list-style-type: none"> <li>• Use the <b>Flash On</b>  setting (see page 32) to brighten the subject. This is called fill-flash.</li> <li>• Increase the <b>EV Compensation</b> (see page 44).</li> </ul>
	Your finger blocked the flash.	Be sure to move your fingers away from the flash when you take a picture.

<b>Problem</b>	<b>Possible Cause</b>	<b>Solution</b>
<b>My image is too dark</b> (continued).	The Display Brightness needs to be adjusted.	Set the <b>Display Brightness</b> in the <b>Setup Menu</b> to <b>Medium</b> or <b>High</b> (see page 66).
<b>My image is grainy.</b>	The <b>ISO Speed</b> setting was too high.	Use a lower <b>ISO Speed</b> setting (see page 47).
	The <b>Image Quality</b> setting was too low.	Use a higher Image Quality setting, such as <b>4MP Best</b> , which has the lowest image compression (see page 40).
	There was not enough light.	<ul style="list-style-type: none"> <li>• Wait for natural lighting conditions to improve.</li> <li>• Add indirect lighting.</li> <li>• Use the flash (see page 32).</li> </ul>
	The camera was too warm when the picture was taken. The camera may have been on for a long time or stored in a hot location. As the camera gets hotter, images you take may have more noise, resulting in more graininess.	The effect will diminish as the camera cools. For best image quality, avoid storing the camera in very hot locations.

<b>Problem</b>	<b>Possible Cause</b>	<b>Solution</b>
<b>Images are missing on my camera.</b>	You installed a memory card after taking one or more images. When you install a memory card, images in internal memory are not visible.	Move the images from the internal memory to the memory card (see page 71) or remove the memory card.
<b>Some menu options are grayed out in the Playback Menu.</b>	The option is not available for the image.	This is normal behavior. For example, if a video clip is selected, you cannot rotate it.
	The image was taken with another camera and cannot be edited on this camera.	Transfer the images from the camera to your computer (see page 61), then view or modify them using the HP Image Zone software.
<b>The wrong date and/or time is shown.</b>	The date and/or time was set incorrectly or the time zone has changed.	Reset the date and time by using the <b>Date &amp; Time</b> option in the <b>Setup Menu</b> (see page 68).
	The batteries were drained or were removed from the camera for too long.	Reset the date and time by using the <b>Date &amp; Time</b> option in the <b>Setup Menu</b> (see page 68).

<b>Problem</b>	<b>Possible Cause</b>	<b>Solution</b>
<b>The camera responds very sluggishly when trying to review images.</b>	A slow optional memory card (like an MMC card) that is installed or too many images on the card can affect processing times.	See <b>Storage</b> on page 129 and <b>Memory Capacity</b> on page 131 for tips about memory cards.
	The camera may be processing an image.	Wait until the Power/Memory light turns solid green, indicating that the camera has finished processing.
<b>I cannot transfer images from the camera to my computer.</b>	The HP Image Zone software is not installed on the computer.	Either install the HP Image Zone software (see page 17), or see <b>Using Your Camera without Installing the HP Image Zone Software</b> on page 77.
	The computer is unable to understand the Picture Transfer Protocol (PTP) standard.	Set your camera to act as a <b>Disk Drive</b> (see page 81).

<b>Problem</b>	<b>Possible Cause</b>	<b>Solution</b>
<b>I receive an error message while transferring images from the camera to my computer.</b>	A power surge or electrostatic discharge may have interrupted the transfer.	Close the HP Image Zone Transfer software, disconnect the camera from the computer, and reset the camera (see page 74). Then, restart the image transfer process (see page 61).
<b>I am having a problem installing or using the HP Image Zone software.</b>	Your computer does not have enough RAM to install the software.	<ul style="list-style-type: none"> <li>• Refer to the computer requirements (see page 75).</li> <li>• Refer to the HP Customer Support website: <b><a href="http://www.hp.com/support">www.hp.com/support</a></b>.</li> </ul>

# Error Messages on the Camera

Message	Possible Cause	Solution
<b>BATTERIES DEPLETED.</b> Camera is shutting down.	Battery power is too low to continue operation.	Replace or recharge the batteries.
<b>Batteries are too low to take pictures.</b>	Battery power is too low to take a still picture or video, but you can still view images in <b>Playback</b> . This message appears sooner with Alkaline batteries than with NiMH or Lithium batteries.	Replace or recharge the batteries.
<b>UNSUPPORTED CARD</b>	The optional memory card that is installed in the memory slot is not a supported memory card.	Ensure that the memory card is the proper type for your camera (see page 129). If it is the proper type, try reformatting the memory card (see page 55).

<b>Message</b>	<b>Possible Cause</b>	<b>Solution</b>
<b>CARD IS UNFORMATTED.</b> Press OK to format card.	The optional memory card that is installed needs to be formatted.	Format the memory card by following the instructions on the Image Display (or remove the card from the camera if you do not want it to be formatted). Formatting the memory card will delete all files on the card.
<b>CARD HAS WRONG FORMAT.</b> Press OK to format card.	The optional memory card that is installed is formatted for a different device, such as an MP3 player.	Re-format the memory card by following the instructions on the Image Display (or remove the card from the camera if you do not want it to be re-formatted). Formatting the memory card will delete all files on the card.
<b>Unable to Format.</b>	The optional memory card that is installed is corrupted.	Replace the memory card, or if you have a memory card reader, try formatting the card on your computer. See your card reader documentation for instructions.
<b>CARD LOCKED</b>	The optional memory card that is installed is locked.	With the camera turned off, remove the memory card from the camera and switch the locking tab on the card to the unlocked position.



<b>Message</b>	<b>Possible Cause</b>	<b>Solution</b>
<b>MEMORY FULL</b> or <b>CARD FULL</b>	There is insufficient room to save more images in internal memory or on the optional memory card that is installed.	Transfer images from the camera to your computer, then delete all images in internal memory or on the memory card (see page 55). Or replace the card with a new one.
<b>Memory/card too full to record audio.</b>	There is insufficient room to record audio in internal memory or on the optional memory card that is installed.	Transfer images, video clips, and/or audio files from the camera to your computer, then delete enough files in internal memory or on the memory card to make enough room for the audio recording (see page 55). Or replace the card with a new one.
<b>Insufficient space on card to rotate image.</b> or <b>Insufficient space in memory to rotate image.</b>	There is insufficient room in internal memory or on the optional memory card to save a rotated image.	<ul style="list-style-type: none"> <li>• Delete an image to free up memory space, then try rotating the image again.</li> <li>• Transfer images from the camera to your computer, then rotate the image using the HP Image Zone software or another image editing package.</li> </ul>

Message	Possible Cause	Solution
<b>The image is too large to magnify.</b>	The image was probably taken with another camera.	Transfer the image to your computer and resize it using the HP Image Zone software.
<b>The image is too large to rotate.</b>	The image was probably taken with another camera.	Transfer the image to your computer and rotate it using the HP Image Zone software.
<b>CARD IS UNREADABLE</b>	The camera is having trouble reading the optional memory card that is installed. The card may be corrupted or an unsupported type.	<ul style="list-style-type: none"> <li>• Try turning the camera off and then back on.</li> <li>• Ensure that the memory card is the proper type for your camera (see page 129). If the memory card is the proper type, try re-formatting the card using the <b>Format</b> option in the <b>Delete</b> sub-menu of the <b>Playback Menu</b> (see page 55). If it will not format, it is probably corrupted. Replace the memory card.</li> </ul>
<b>Unknown image error. Unable to complete request.</b>	The camera could not complete the image modification you requested.	<ul style="list-style-type: none"> <li>• Try modifying the image again.</li> <li>• If the same message displays, transfer the image to your computer and modify it using the HP Image Zone software.</li> </ul>

<b>Message</b>	<b>Possible Cause</b>	<b>Solution</b>
<b>PROCESSING...</b>	The camera is processing data, such as saving the last picture you took.	If you are in <b>Live View</b> , wait a few seconds for the camera to finish processing before taking another picture or pressing another button.
<b>CHARGING FLASH...</b>	The camera is recharging the flash.	It takes longer to charge the flash when the battery is low. If you see this message a lot, you may need to replace or recharge the battery.
<b>ERROR SAVING IMAGE.</b> or <b>ERROR SAVING VIDEO.</b>	The optional memory card that is installed was removed before the camera finished writing to the card or was half-locked.	<ul style="list-style-type: none"> <li>• Always wait until the Power/Memory light stops blinking before removing the memory card from the camera.</li> <li>• With the camera turned off, remove the memory card and check to see if the locking tab on the edge of the card is fully in the unlocked position.</li> </ul>

<b>Message</b>	<b>Possible Cause</b>	<b>Solution</b>
<b>Cannot display image &lt;filename&gt;.</b>	The image was taken with another camera or the image file was corrupted when the camera was shut down improperly.	<ul style="list-style-type: none"> <li>• The image may still be okay. Transfer the image to a computer and try opening it with the HP Image Zone software.</li> <li>• Do not remove the memory card when the camera is turned on.</li> </ul>
<b>Camera has experienced an error.</b> or <b>Camera has experienced an error and is shutting down.</b>	The camera may have experienced a transient problem.	Turn the camera off, if it is on, and then on again. If that does not fix the problem, try resetting the camera (see page 74). If the problem persists, note the error code and then call HP Support (see page 106).
<b>Unknown USB device.</b>	The camera is connected to a USB device that it does not recognize.	Make sure that the camera is connected to a supported printer or computer.
<b>Unsupported printer</b>	The printer is an unsupported device.	Connect the camera to a PictBridge-certified printer. Or connect the camera to a computer and print from there instead.

<b>Message</b>	<b>Possible Cause</b>	<b>Solution</b>
<b>Unable to communicate with printer.</b>	There is no connection between the camera and printer.	<ul style="list-style-type: none"> <li>• Check that the printer is turned on.</li> <li>• Make sure the cable is connected between the printer and the camera. If that does not work, turn off the camera and disconnect it from the USB cable. Turn the printer off and then on again. Re-connect the camera and turn it on.</li> </ul>
<b>Unable to Print. Error reading image file.</b>	The image file may be corrupt, or too large.	<ul style="list-style-type: none"> <li>• Turn off the camera. Re-connect the camera and turn it on.</li> <li>• If that does not work, transfer the image file to your computer and try printing the image file from the computer.</li> </ul>
<b>No printable images in memory.</b> or <b>No printable images on card.</b>	The camera has no still images. Video clips cannot be printed directly from the camera.	Disconnect the camera from the printer, then take still images before reconnecting the camera to the printer.
<b>Cannot print video clips.</b>	You tried to select video clip for printing. Video clips cannot be printed from the camera.	If your printer supports printing video clips, transfer the video clip to your computer and print them from your computer.

<b>Message</b>	<b>Possible Cause</b>	<b>Solution</b>
<b>Printer top cover is open.</b>	The printer is open.	Close the top cover of the printer.
<b>Incorrect or missing print cartridge.</b> or <b>Incorrect or missing print head.</b>	The printer cartridge is the incorrect model or is missing.	Install a new printer cartridge, turn the printer off, then turn it back on.
<b>The selected combination of paper type and size is not supported.</b>	You are trying to print a picture larger than the paper size, you are trying to print borderless prints on plain paper, or your printer does not support borderless prints.	Try selecting a smaller print size, or try using photo paper to make borderless prints.
<b>There is a problem with the printer's ink.</b>	The ink cartridge may be low or the ink cartridge may not be supported for the printer.	Install a supported printer cartridge, turn the printer off, then turn it back on.
<b>Low ink.</b>	The printer cartridge is running low on ink.	Replace the ink cartridge. You may be able to print some images using the current cartridge, but their color and quality may not be of high quality.

<b>Message</b>	<b>Possible Cause</b>	<b>Solution</b>
<b>Printer is out of ink.</b>	The printer cartridge is empty.	Replace the ink cartridge.
<b>Printer ink cover is open.</b>	The printer ink cover is open	Close the ink cover.
<b>Paper error.</b>	The paper tray may be empty or there may be a paper jam.	<ul style="list-style-type: none"> <li>• Examine the paper tray. If it is empty, refill it.</li> <li>• Examine the paper path for a paper jam. If you find one, clear it.</li> </ul>
<b>Paper is not loaded correctly in the printer.</b>	The paper is not aligned correctly in the paper tray.	Realign the paper in the tray.
<b>Printer has a paper jam.</b>	There is a paper jam.	Turn off the printer. Completely clear the paper jam, then turn the printer back on.
<b>Printer is out of paper.</b>	The printer is out of paper.	Load paper into the printer, and then press the <b>OK</b> or <b>Continue</b> button on the printer.
<b>Printer error.</b>	There is a problem with the printer.	Turn the printer off, then on again. Press the $\frac{\text{Menu}}{\text{OK}}$ button on the camera. Complete the print request again.

# Error Messages on the Computer

Message	Possible Cause	Solution
<b>Cannot Connect To Product</b>	The camera is turned off.	Turn on the camera.
	The camera is not working correctly.	Try connecting the camera directly to a PictBridge-certified printer, and print an image. This will verify that the optional memory card, USB connection, and the USB cable are functioning correctly.
	The cable is not connected correctly.	Make sure that the cable is firmly connected to the computer and camera.
	The camera is set to the <b>Digital Camera</b> setting, but the computer cannot recognize the camera as a digital camera.	Change the <b>USB</b> setting to <b>Disk Drive</b> (see page 69). The camera then appears as another disk drive on the computer so you can copy the image files to the computer.
	The camera is connected to the computer through a USB hub, and your USB hub is not compatible with the camera.	Connect the camera directly to a USB port on the computer.



<b>Message</b>	<b>Possible Cause</b>	<b>Solution</b>
<b>Cannot Connect To Product</b> (continued)	The optional memory card that is installed is locked.	With the camera turned off, remove the memory card and switch the locking tab on the card to the unlocked position.
	The USB connection failed.	Reboot the computer.
<b>Could Not Send To Service</b>	The computer is not connected to the Internet.	Make sure your computer is online.

# Getting Assistance

This section contains support information for your digital camera, including support website information, an explanation of the support process, and support phone numbers.

## HP Accessibility Website

Customers with disabilities can get help by visiting [www.hp.com/hpinfo/community/accessibility/prodserv](http://www.hp.com/hpinfo/community/accessibility/prodserv).

## HP Photosmart Website

Visit [www.hp.com/photosmart](http://www.hp.com/photosmart) for the following information:

- Tips on using your camera more effectively and creatively
- HP digital camera driver updates and software
- Register your product
- Subscribe to newsletters, driver and software updates, and support alerts

## Support Process

The HP support process works most effectively if you perform the following steps in the order specified:

1. Review the troubleshooting section of this User's Manual (see **Problems and Solutions** on page 83).
2. Access the HP Customer Support website for support. If you have access to the Internet, you can obtain a wide range of information about your digital camera. Visit the HP website for product help, drivers, and software updates at [www.hp.com/support](http://www.hp.com/support).

This website is available in the following languages: Dutch, English, French, German, Italian, Portuguese, Spanish, Swedish, Traditional Chinese, Simplified Chinese, Japanese, Korean. (Danish, Finnish, and Norwegian support information is available in English only.)

3. Access HP e-support. If you have access to the Internet, connect with HP via e-mail by going to:  
**www.hp.com/support**. You will receive a personal reply from an HP Customer Support technician. E-mail support is available in the languages listed at that website.
4. (US and Canadian customers, skip this step and go on to Step 5.) Contact your local HP dealer. If your digital camera has a hardware failure, take it to your local HP dealer for a solution. Service is free during your digital camera's limited warranty period.
5. Contact HP Customer Support for support by phone. If you cannot solve the problem using the above options, you can call HP for support. Check **www.hp.com/support** for contact details.

## Phone Support

Phone support is available both during and after the warranty period.

Call HP while you are in front of your computer and digital camera. For faster service, please be prepared to provide the following information:

- The digital camera's model number (on the front of the camera)
- The digital camera's serial number (on the bottom of the camera)

- The computer's operating system and available RAM
- The version of the HP software (on the CD label)
- Messages displayed at the time the situation occurred

The applicable conditions for HP phone support are subject to change without notice. See the following pages for the telephone support number for your country/region.

HP Customer Support phone numbers and policies may change. Visit the following website to check the details and conditions of phone support in your country/region:

**[www.hp.com/support](http://www.hp.com/support)**

#### **Within the period of your warranty:**

- **Africa, Asia Pacific, Canada, Latin America, and Middle East:** Telephone support is free for one year from the date of purchase.
- **United States:** 90 day limited warranty.
- **Europe:** One-year limited warranty.

**NOTE:** Different warranty regulations might apply per country/region according to local laws.

**After the warranty period,** you have different options depending on the region where you reside:

- **United States, Canada, and Asia Pacific:** Call HP Customer Support; however there will be a per-incident fee.
- **Europe:** Return product to your dealer OR call HP Customer Support; however there will be a per-incident fee.
- **Latin America:** Call HP Customer Support (after October 31, 2005, a fee will be charged).

## Phone Support Numbers

If your country or region does not appear in the following lists, please refer to [www.hp.com/support](http://www.hp.com/support) for support information.

Australia	1300 721 147
Australia (out-of-warranty)	1902 910 910
中国	021-3881-4518 800-810-3888 服务编码: 3003
香港特別行政區	2802 4098
India	1 600 44 7737
Indonesia	+62 (21) 350 3408
日本	0570-000511
日本 (携帯電話の場合)	03-3335-9800
한국	1588-3003
Malaysia	1800 805 405
New Zealand	0800 441 147
Philippines	2 867 3551
Singapore	6 272 5300
臺灣	02-8722-8000
ไทย	+66 (2) 353 9000
Việt Nam	+84 88234530

Argentina (Buenos Aires)	54-11-4708-1600
Argentina	0-800-555-5000
Brasil (Sao Paulo)	55-11-4004-7751
Brasil	0-800-709-7751
Canada	1-800-474-6836
Chile	800-360-999
Colombia (Bogota)	571-606-9191
Colombia	01-8000-51-4746-8368
Costa Rica	0-800-011-1046
Ecuador (Andinatel)	1-999-119
	800-711-2884
Ecuador (Pacifitel)	1-800-225-528
	800-711-2884
El Salvador	800-6160
Guatemala	1-800-711-2884
Jamaica	1-800-711-2884
Mexico (Mexico City)	55-5258-9922
Mexico	01-800-472-68368
Panama	1-800-711-2884
Paraguay	009 800 54 1 0006
Perú	0-800-10111
Puerto Rico	1-877-232-0589
República Dominicana	1-800-711-2884
Trinidad & Tobago	1-800-711-2884
United States	1-800-474-6836
Uruguay	0004-054-177
Venezuela (Caracas)	58-212-278-8666
Venezuela	0-800-474-68368

---

# A Managing Batteries

Your camera uses two AA batteries. For best results, use Energizer Lithium AA or rechargeable Nickel Metal Hydride (NiMH) AA batteries. Alkaline batteries provide far less battery life than Lithium or NiMH batteries.

## Top Points About Batteries

- The first time that you use a set of NiMH batteries, be sure that you fully charge them before using them in the camera.
- If you do not intend to use your camera for extended periods of time (more than two months), HP recommends that you remove the batteries.
- When inserting the batteries in the camera, always be sure to orient the batteries as directed by the markings in the battery compartment. If the batteries are inserted improperly, the compartment door may close but the camera will not operate.
- Never use batteries of different chemistries (for example, a Lithium battery and a NiMH battery), brands, or ages. This can cause erratic camera behavior, as well as battery leakage. Always use two identical batteries of the same chemistry, brand, and age.

- The performance of all batteries will decrease as the temperature drops. For best performance in cold environments, use Energizer Lithium AA batteries. NiMH batteries may also provide acceptable low temperature performance. To improve the performance of all battery types, keep the camera and/or batteries stored in a warm inside pocket when in a cold environment.

## Extending Battery Life

Here are some tips for extending battery life:

- Change the **Display Brightness** setting in the **Setup Menu** to **Low**, so that the Image Display consumes less power when in **Live View** (see **Display Brightness** on page 66).
- Minimize the use of flash by setting your camera to **Auto Flash**, instead of **Flash On** (see **Setting the Flash** on page 32).
- Turn the camera off between shots.

## Safety Precautions for Using Batteries

- Do not charge any batteries other than NiMH batteries in the optional HP Photosmart Quick Recharger.
- Do not place a battery in fire or heat the battery.
- Do not connect the positive terminal and the negative terminal of a battery to each other with any metal object (such as wire).
- Do not carry or store a battery together with coins, necklaces, hairpins, or other metal objects. Placing an NiMH battery in contact with coins is especially dangerous to you! To avoid injury, do not drop this battery into a coin-filled pocket.



- Do not pierce the battery with nails, strike the battery with a hammer, step on the battery, or otherwise subject it to strong impacts or shocks.
- Do not solder directly onto the battery.
- Do not expose the battery to water or salt water, or allow the battery to get wet.
- Do not disassemble or modify the battery. The battery contains safety and protection devices, which, if damaged, may cause the battery to generate heat, explode, or ignite.
- Immediately discontinue use of the battery if, while using, charging, or storing the battery, the battery emits an unusual smell, feels excessively hot (note that it is normal for the battery to feel warm), changes color or shape, or appears abnormal in any other way.
- In the event the battery leaks and the fluid gets into your eye, do not rub the eye. Rinse well with water and immediately seek medical care. If left untreated, the battery fluid could cause damage to the eye.

# Performance per Battery Type

The following table shows how Alkaline, Lithium, and rechargeable NiMH batteries perform in different types of use scenarios.

Type of use	Alkaline	Lithium	NiMH
Most economical if you take more than 30 pictures per month	Poor	Fair	Good
Most economical if you take fewer than 30 pictures per month	Fair	Good	Fair
Heavy use of flash, frequent pictures	Poor	Good	Good
Heavy use of video	Poor	Good	Good
Heavy use of <b>Live View</b>	Poor	Good	Good
Overall battery life	Poor	Good	Fair
Low temperature/winter use	Poor	Good	Fair
Infrequent use	Fair	Good	Fair
Want to recharge batteries	No	No	Good

# Number of Shots per Battery Type

The following table shows the minimum, maximum, and average number of shots that may be obtained using Alkaline, Lithium, and rechargeable NiMH batteries.





<b>Battery type</b>	<b>Minimum number of shots</b>	<b>Maximum number of shots</b>	<b>Approximate number of shots under average use</b>
Alkaline	80	130	100
NiMH	110	280	190
Lithium	260	490	340

In the above table, please note that in all cases, four pictures are taken per session with at least a 5 minute break between sessions. In addition:

- The minimum number of shots is obtained with extensive use of **Live View** (30 seconds per picture), **Playback** (15 seconds per picture), and **Flash On**.
- The maximum number of shots is obtained with minimal use of **Live View** (10 seconds per picture) and **Playback** (4 seconds per picture). Flash is used on 25% of shots.
- The average number of shots is obtained with **Live View** used at 15 seconds per picture and **Playback** used for 8 seconds per picture. Flash is used on 50% of shots.

# Power Indicators

The following icons may be displayed on the status screen, in **Live View**, in **Playback**, and when the camera is connected to a computer or printer. If no icon is displayed, this means that the camera has sufficient battery power to function normally.

Icon	Description
	Batteries have more than 70 percent energy remaining.
	Batteries have 30 to 70 percent energy remaining.
	Batteries have 10 to 30 percent energy remaining.
	Batteries' level is low. Only Playback mode available: camera will not take pictures.
 <b>Blinking</b>	Batteries are depleted. Camera will power down.

# Recharging NiMH Batteries

NiMH batteries can be recharged with the optional HP Photosmart battery quick recharger. For information about this optional accessory, see **Appendix B, Purchasing Camera Accessories**, starting on page 121.

The following table shows the average time it takes to recharge NiMH batteries that have been fully discharged when the batteries are being charged in the HP quick recharger. The table also notes the signal you will see when the batteries have been recharged.

Average charge time	Signal when charging has completed
1 hour for 2 batteries. About 2 hours for 4 batteries	Light on quick recharger turns on solid green.

Some things to keep in mind when using NiMH batteries are as follows:

- The first time that you use a set of NiMH batteries, be sure that you fully charge them before using them in the camera.
- You may notice that the first several times you use NiMH batteries, the battery life seems shorter than what you expect. Performance will improve and become optimal after the batteries have been charged and then discharged (used) completely four or five times. You can use the camera normally to discharge the batteries during this conditioning period.
- Always recharge both NiMH batteries at the same time. One low-charged battery will reduce the battery life for the other battery in the camera.

- NiMH batteries discharge when not in use, whether they are installed in a camera or not. If they have not been used for more than two weeks, recharge them before using them again. Even if you are not using your batteries, it is a good idea to charge them every six months to a year to prolong their useful life.
- The performance of all rechargeable batteries, including NiMH, will degrade over time, especially if they are stored and used at high temperatures. If battery life has become unacceptably reduced over time, replace the batteries.
- The quick recharger may be warm while operating and charging NiMH batteries. This is normal.
- NiMH batteries can be left in the quick recharger for any period of time without harm to the batteries. Always store charged batteries in a cool location.

# Safety Precautions for Recharging NiMH Batteries

- Do not charge any batteries other than NiMH batteries in the quick recharger.
- Insert the NiMH batteries in the correct orientation in the quick recharger.
- Use the quick recharger in a dry location only.
- Do not charge NiMH batteries in a hot location, such as in direct sunlight or near a fire.
- When recharging NiMH batteries, do not cover the quick recharger in any way.
- Do not operate the quick recharger if the NiMH batteries appear damaged in any way.
- Do not disassemble the quick recharger.
- Unplug the quick recharger from the electrical outlet before cleaning the quick recharger.

## Sleep Time-out for Power Conservation

To conserve battery power, the Image Display turns off automatically if there is no button activity for one minute. When the camera is connected to a computer, the Image Display turns off automatically 10 seconds after the connection is made. When the camera is in this sleep state, pressing any button will wake up the camera again. If no buttons are pressed during the sleep state, the camera will turn off after an additional 5 minutes.





---

## B Purchasing Camera Accessories

You can purchase additional accessories for your camera.

For information on your HP E217 camera and compatible accessories, go to:

- [www.hp.com/photosmart](http://www.hp.com/photosmart) (US)
- [www.hp.ca/photosmart](http://www.hp.ca/photosmart) (Canada)
- [www.hp.com](http://www.hp.com) (all other countries)

To purchase accessories, visit your local retailer or order online at:

- [www.hpshopping.com](http://www.hpshopping.com) (US)
- [www.hpshopping.ca](http://www.hpshopping.ca) (Canada)
- [www.hp.com/eur/hpoptions](http://www.hp.com/eur/hpoptions) (Europe)
- [www.hp.com/apac/homeandoffice](http://www.hp.com/apac/homeandoffice) (Asia Pacific)

Below are some accessories for this digital camera. These camera accessories may not be available in all regions.

- **HP Photosmart M-series quick recharge kit**  
(L1815A/L1815B)

One hour recharging of AA NiMH batteries, plus stylish protection for your HP Photosmart E-series camera.

Includes all you need to provide a home away from home for your camera: an ultra-lightweight portable recharger, a camera case, and four high-capacity rechargeable AA NiMH batteries.

- **HP Photosmart SD memory cards** (For important information about supported types of memory cards, see **Storage** on page 129.)
  - HP Photosmart 64MB SD memory card (L1872A/L1872B)
  - HP Photosmart 128MB SD memory card (L1873A/L1873B)
  - HP Photosmart 256MB SD memory card (L1874A/L1874B)
  - HP Photosmart 512MB SD memory card (L1875A/L1875B)
  - HP Photosmart 1GB SD memory card (L1876A / L1876B)
- **HP Photosmart camera cases**

Protect your camera with a compact padded case. Includes neck strap, belt loop, and an organizer for memory cards. Available in either black (Q6216A) or silver (Q6217A).

---

# C Caring for Your Camera

Your HP camera has been designed to withstand most conditions under which you would normally take pictures. However, you should take some basic precautions when using your camera (see **Basic Camera Care** below) and clean it regularly (see **Cleaning the Camera** on page 125).

## Basic Camera Care

You should take some basic precautions to ensure that your camera continues to perform optimally.

- Before storing the camera, wipe moisture from the camera body with a clean, dry, soft cloth.
- Whenever you go from a cold location to a warm one (from a snowy mountain to a hotel room, for example), wrap the camera tightly in a plastic bag. Let the camera adapt to the warmer temperature for about an hour before removing it from the plastic bag. Doing so will help prevent condensation inside the camera and extend its life.
- Store your digital camera in a cool, dry place away from windows, furnaces, and damp basements.
- Always slide the lens cover over the lens when you are not using your camera. This precaution not only protects the lens from dust and scratches but also conserves battery life.

- Always turn the camera off when you are not using it to protect the lens. When the camera is off, the camera lens retracts and the lens wink mechanism closes over the lens to protect it.
- Clean your camera body, Image Display, and lens regularly with cleaning supplies designed specifically for cameras. See **Cleaning the Camera** on page 125.
- Keep your camera and accessories in a padded case with a good strap for easy transport. Most HP digital camera cases have built-in pockets for batteries and memory cards. See **Purchasing Camera Accessories** on page 121.
- Always keep your camera equipment with you as carry-on when you travel. Never check it with suitcases, since rough handling and extreme weather can damage it.
- Never open your camera's casing or attempt to repair the camera yourself. Touching the inside of a digital camera can result in electrical shock. Contact an authorized HP Service Center for repairs.

**NOTE:** For information about handling batteries safely, see **Appendix A, Managing Batteries**, starting on page 111.

# Cleaning the Camera

**TIP:** If your camera needs cleaning beyond what is described in this section, take the camera to a camera store that specializes in cleaning digital cameras.

Cleaning your camera not only keeps it looking its best, it also improves the quality of your photos. It is especially important to clean the lens regularly because dust particles and fingerprints can mar the quality of any photos you take.

To clean your camera, you will need lens-cleaning tissue and a soft, dry, lint-free cloth commonly available at photo-specialty stores. You can also purchase these items in a camera-cleaning kit.

**NOTE:** You should purchase lens-cleaning tissue that has not been chemically treated. Some chemically treated lens tissue can cause scratching of the lens and Image Display.

## Cleaning the Camera Lens

Do the following to remove any fingerprints, dust, and so forth that have accumulated on the lens.

1. Slide the lens cover to uncover the lens.
2. Blow gently on the lens to remove dust.
3. Lightly wipe the lens with lens-cleaning tissue, using a circular motion.

# Cleaning the Camera Body and Image Display

Do the following to remove any fingerprints, dust, moisture, and so forth that have accumulated on the camera body and Image Display.

1. Blow gently on the Image Display to eliminate dust.
2. Wipe the entire surface of the camera and the Image Display using a clean, dry, soft cloth.

**NOTE:** You can also wipe the Image Display with lens-cleaning tissue.

# D Specifications

Feature	Description
<b>Resolution</b>	Still pictures: <ul style="list-style-type: none"><li>• 4.06 MP (2332 by 1740) total pixel count</li><li>• 4.01 MP (2320 by 1728) effective pixel count</li></ul> Video clips: <ul style="list-style-type: none"><li>• QVGA 256 by 192 at 24 frames per second</li></ul>
<b>Sensor</b>	Diagonal 7.2 mm (1/2.5-inch, 4:3 format) CCD
<b>Color depth</b>	36 bit (12 bits by 3 colors)
<b>Lens</b>	Focal length: <ul style="list-style-type: none"><li>• 7.7 mm</li><li>• 35 mm equivalent, approximately 46.1 mm</li></ul> F-Number: f/3.5
<b>Lens threads</b>	None
<b>Zoom</b>	4x digital zoom
<b>Focus</b>	Fixed focus. Focus ranges: <ul style="list-style-type: none"><li>• Normal (default)—1 m (39 in) to infinity</li><li>• Macro—60 cm to 1m (24 to 39 in)</li></ul>
<b>Shutter speed</b>	1/2000 to 2 seconds
<b>Tripod mount</b>	Yes
<b>Built-in flash</b>	Yes, 6-second typical recharge time
<b>Flash working range</b>	Maximum with <b>ISO Speed</b> set to <b>Auto</b> : 5 meters (16.5 feet)
<b>External flash</b>	No

<b>Feature</b>	<b>Description</b>
<b>Flash settings</b>	<b>Flash Off, Auto Flash</b> (default), <b>Red-Eye, Flash On</b>
<b>Image Display</b>	1.5-inch color active matrix TFT LTPS with backlight, 130,000 pixels (557 by 234)
<b>Image capture options</b>	<ul style="list-style-type: none"> <li>• <b>Still</b> (default)</li> <li>• <b>Self-Timer</b>—still picture or video clip taken after 10-second delay</li> <li>• <b>Video</b>—24 frames per second (includes audio), until the camera runs out of memory</li> </ul>
<b>Audio capture</b>	<ul style="list-style-type: none"> <li>• <b>Still pictures</b>—audio clip length is 30 seconds or until the camera runs out of memory, whichever comes first</li> <li>• <b>Video clips</b>—audio is recorded automatically</li> </ul>
<b>Shooting modes</b>	<b>Auto</b> (default), <b>Action, Landscape, Portrait, Sunset</b>
<b>Image Quality settings</b>	<ul style="list-style-type: none"> <li>• <b>4MP Best</b></li> <li>• <b>4MP</b> (default)</li> <li>• <b>2MP</b></li> <li>• <b>VGA</b></li> </ul>
<b>Date &amp; Time Imprint settings</b>	<b>Off</b> (default), <b>Date Only, Date &amp; Time</b>
<b>EV Compensation settings</b>	Can be set manually from -2.0 to +2.0 EV (Exposure Value) in 1/3 EV increments.
<b>White Balance settings</b>	<b>Auto</b> (default), <b>Sun, Shade, Tungsten, Fluorescent</b>
<b>ISO Speed settings</b>	<b>Auto</b> (default), <b>100, 200, 400</b>



Feature	Description
<b>Compression format</b>	<ul style="list-style-type: none"> <li>• JPEG (EXIF) for still images</li> <li>• EXIF2.2 for still images with embedded audio</li> <li>• MPEG1 for video clips</li> </ul>
<b>Storage</b>	<ul style="list-style-type: none"> <li>• 16MB internal flash memory</li> <li>• Slot for memory card</li> <li>• This camera supports both standard and high-speed HP-branded Secure Digital (SD) and MultiMediaCard (MMC) memory cards 16MB and larger. Only MMC cards that have been verified compliant to the MultiMediaCard specification are supported. Compliant MMC memory cards have the  MultiMediaCard logo on the card or package. While other SD and MMC cards may work in your camera, only HP-branded cards are supported.</li> <li>• SD cards are recommended, as they are faster than MMC cards at reading and writing data.</li> <li>• This camera supports memory cards up to 1GB. A high capacity card does not affect camera performance.</li> <li>• The number of images that can be saved in memory depends on the <b>Image Quality</b> settings (see <b>Memory Capacity</b> on page 131).</li> </ul>

<b>Feature</b>	<b>Description</b>
<b>Power</b>	<p>Typical power usage: 1.8 Watts with Image Display on. 3.6 Watts maximum power usage. Power sources can be either:</p> <ul style="list-style-type: none"> <li>• Two non-rechargeable AA Lithium batteries, or</li> <li>• Two rechargeable AA NiMH batteries.</li> </ul> <p>Rechargeable batteries can be recharged in the optional HP Photosmart Quick Recharger. Average recharging time of NiMH batteries is provided in the section <b>Recharging NiMH Batteries</b> on page 117.</p>
<b>Standards</b>	<ul style="list-style-type: none"> <li>• PTP transfer (15740)</li> <li>• MSDC transfer</li> <li>• JPEG</li> <li>• MPEG1 level 1</li> <li>• DPOF 1.1</li> <li>• EXIF 2.2</li> <li>• DCF 1.0</li> <li>• DPS</li> </ul>
<b>Interfaces</b>	USB mini B connector to a computer or PictBridge-certified printer
<b>External body dimensions</b>	99.3 mm (L) by 32 mm (W) by 52.6 mm (H) 3.91 in (L) by 1.40 in (W) by 2.07 in (H)
<b>Weight</b>	110 grams (0.23 pounds) without battery
<b>Temperature range</b>	<p>Operational: 0 to 50° C (32 to 122° F) at 15 to 85% relative humidity</p> <p>Storage: -30 to 65° C (-22 to 149° F) at 15 to 90% relative humidity</p>

# Memory Capacity

The following table lists the approximate number and average size of still images that can be stored in the internal memory in the camera when the camera is set to different **Image Quality** settings available in the **Capture Menu**.

**NOTE:** Not all 16MB of internal memory is available for storing images, because some memory is used for internal camera operations. Also, the actual file sizes and number of still images that can be stored in the internal memory in the camera or on an optional memory card will vary, depending on the content of each still image and the length of the recorded audio clip.

<b>4MP Best</b>	9 images (1.2MB each)
<b>4MP</b> (default)	12 images (900KB each)
<b>2MP</b>	25 images (500KB each)
<b>VGA</b>	95 images (120KB each)

**NOTE:** The values shown are for images without audio clips.



---

# Index

## A

- AA batteries,
  - types to use 111
- accessories for camera 121
- Action mode, setting 38
- arrow buttons on
  - Controller 20
- audio clips, record 60
- automatic exposure,
  - override 38

## B

- batteries
  - door on camera 20
  - extend life of 112
  - indicators 116
  - install 11
  - performance 114
  - quick recharge kit 121
  - recharging NiMH 117
  - shots per type 115
  - top points about use 111
  - types to use 111
- blinking lights on
  - camera 20, 22
- brightening an image 44
- buttons on camera 19

- buying camera
  - accessories 121

## C

- camera
  - accessories 121
  - cleaning the body 126
  - cleaning the image
    - display 126
  - cleaning the lens 125
  - general care 123
  - general cleaning 125
  - menus 24
  - reset 74
  - specifications 127
  - states 24
  - turn on/off 12
- camera care
  - cleaning the body 126
  - cleaning the image
    - display 126
  - cleaning the lens 125
  - general 123
  - general cleaning 125
- camera parts
  - back of camera 19
  - front, left side, and bottom of camera 22

- top of camera 21
- Camera Sounds, setting 67
- capacity of
  - internal memory 131
- Capture Menu 37
- cleaning
  - body 126
  - image display 126
  - lens 125
- compression format 129
- computer,
  - connect camera to 61
- connections
  - as a Picture Transfer Protocol (PTP) device 69
  - as a USB Mass Storage Device Class (MSDC) 69
  - to computer 61
  - to printer 62
- connector, USB 22
- conserving battery life 112
- Controller with arrow buttons, description 20
- customer support 106

**D**

- darkening an image 44
- Date & Time Imprint 42
- Date & Time, setting 14, 68

- delete during
  - Instant Review 29, 30
- Delete, using 55
- digital zoom 31
- direct print
  - printing images from camera to printer or computer 62
- disk drive, camera as 69
- Display Brightness 66

## E

- error messages
  - on camera 95
  - on computer 104
- EV Compensation 44
- extending battery life 112

## F

- flash
  - description 22
  - settings 32
  - using 32
  - working range 127
- Flash button 20
- f-number 127
- focus mode
  - settings 34
  - switch 23
- focus range 127

- format
  - internal memory 55
  - memory card 15, 55

## H

- help from
  - customer support 106
- HP Image Zone Express
  - software, description 76
- HP Image Zone software
  - description 75
  - installing 17
  - not using 77
  - Windows
    - requirements 75
- HP web sites 106

## I

- Image Display
  - description 19
  - using 27
- Image Quality, setting 40
- images
  - brightening 44
  - darkening 44
  - Date & Time Imprint 42
  - focus modes 34
  - Image Quality setting 40
  - ISO Speed setting 47
  - magnifying 57
  - number remaining 28, 52

- number saved in internal memory 131
- Print 58
- Rotate 59
- shooting modes 38
- thumbnails view 56
- too dark/light 44
- transferring camera to computer 61
  - White Balance setting 45
- indicators, power 116
- install
  - batteries 11
  - memory card 15
  - software 17, 18
  - wrist strap 10
- internal memory
  - format 55
  - image capacity of 131
  - pictures remaining 28, 52
- ISO Speed, setting 47

## L

- Landscape mode, setting 39
- Language
  - change setting 70
  - choose at first startup 13
- LEDs (lights) on camera
  - Power light 20
  - Self-Timer/Video light 22

- lens cover/power switch, description 22
- life of battery, conserving 112
- Live View 27
- Live View/Playback button, description 19
- low battery indicator 116

## **M**

- Macintosh computer
  - install software 18
  - USB setting on camera 69
- Macro mode
  - setting 34
  - switch 23
- Magnify 57
- memory card
  - door on camera 20
  - format 15, 55
  - install 15
  - pictures remaining 28, 52
  - supported types and sizes 129
- memory, internal
  - format 55
  - image capacity 131
  - pictures remaining 28, 52

- Menu/OK button, description 20
- menus
  - Capture 37
  - overview 24
  - Playback 53
  - Setup 65
- messages
  - on camera 95
  - on computer 104
- microphone, description 23
- Move Images to Card 71

## **N**

- NiMH batteries
  - recharging 117
  - safety precautions 112
- number of
  - images stored in internal memory 131
  - pictures remaining 28, 52

## **O**

- over-exposing an image 44
- override automatic exposure 38

## **P**

- parts of camera
  - back of camera 19
  - front, left side, and bottom of camera 22



- top of camera 21
- performance per battery
  - type 114
- Playback 49
- Playback Menu 53
- Portrait mode, setting 39
- power
  - indicators 116
  - light 20
  - specifications 130
  - turn on/off 12
- power conservation,
  - time-out 119
- Power light, description 20
- print images 58
- print images directly to
  - printer 62
- problems,
  - troubleshooting 73
- product support 106
- purchasing camera
  - accessories 121

## R

- range
  - Exposure
    - Compensation 128
  - flash 127
  - focus 127
- recharging
  - NiMH batteries 117
- record

- audio clips 60
- video clips 30
- red-eye reduction 33
- remaining pictures
  - count 28, 52
- reset camera 74
- Reset Settings 72
- reviewing images 49
- rotate images 59

## S

- safety precautions for NiMH
  - batteries 112
- Self-Timer
  - light 22
  - settings 35
  - Timer button 20
- settings
  - reset 72
- Setup Menu, using 65
- shooting mode
  - settings 38
- Shutter button 21
- shutter speed range 127
- sleep, time-out 119
- software
  - installing 17, 18
  - using camera without 77
- space remaining in
  - memory 28, 52
- specifications 127
- states, camera 24

still pictures, take 29  
Sunset mode, setting 39  
support for users 106

## **T**

technical support 106  
Thumbnails 56  
Time & Date, setting 14, 68  
Timer button 20  
total images summary  
  screen 52  
transfer images to  
  computer 61  
tripod mount,  
  description 23  
troubleshoot problems 73  
turn on/off power 12

## **U**

under-exposing an  
  image 44  
USB  
  configuration setting 69  
  connector on camera 22

## **V**

Video button 21  
video clips, recording 30

## **W**

web sites for HP 106  
White Balance, setting 45

Windows computer  
  install software 17  
  system requirements for  
    software 75  
working range of flash 127  
wrist strap, attaching to  
  camera 10

## **Z**

zoom  
  digital 31  
  specifications 127