

[Home](#)

[safety and  
troubleshooting](#)

[about this  
manual](#)

[product  
information](#)

[installing your  
monitor](#)

[on-screen  
display](#)

[customer care  
and warranty](#)

[download  
& print](#)

# LCD Monitor **220P I / 220B I**

[www.philips.com/welcome](http://www.philips.com/welcome)



Safety Precautions and  
Maintenance

FAQs

Troubleshooting

Regulatory Information

## Safety and Troubleshooting Information

---

### Safety precautions and maintenance



**WARNING: Use of controls, adjustments or procedures other than those specified in this documentation may result in exposure to shock, electrical hazards and/or mechanical hazards.**

Read and follow these instructions when connecting and using your computer monitor:

#### Operation:

- Keep the monitor out of direct sunlight and away from stoves or any other heat source.
- Remove any object that could fall into ventilation holes or prevent proper cooling of the monitor's electronics.
- Do not block the ventilation holes on the cabinet.
- When positioning the monitor, make sure the power plug and outlet are easily accessible.
- If turning off the monitor by detaching the power cable or DC power cord, wait for 6 seconds before attaching the power cable or DC power cord for normal operation.
- Please use approved power cord provided by Philips all the time. If your power cord is missing, please contact with your local service center. (Please refer to Customer Care Consumer Information Center)
- Do not subject the LCD monitor to severe vibration or high impact conditions during operation.
- Do not knock or drop the monitor during operation or transportation.

#### Maintenance:

- To protect your display from possible damage, do not put excessive pressure on the LCD panel. When moving your monitor, grasp the frame to lift; do not lift the monitor by placing your hand or fingers on the LCD panel.
- Unplug the monitor if you are not going to use it for an extensive period of time.
- Unplug the monitor if you need to clean it with a slightly damp cloth. The screen may be wiped with a dry cloth when the power is off. However, never use organic solvent, such as, alcohol, or ammonia-based liquids to clean your monitor.
- To avoid the risk of shock or permanent damage to the set, do not expose the monitor to dust, rain, water, or excessive moisture environment.
- If your monitor gets wet, wipe it with dry cloth as soon as possible.
- If foreign substance or water gets in your monitor, please turn the power off immediately and disconnect the power cord. Then, remove the foreign substance or water, and send it to the maintenance center.

- Do not store or use the LCD monitor in locations exposed to heat, direct sunlight or extreme cold.
- In order to maintain the best performance of your monitor and use it for a longer lifetime, please use the monitor in a location that falls within the following temperature and humidity ranges.
  - Temperature: 0-40°C 32-95°F
  - Humidity: 20-80% RH
- **IMPORTANT:** Always activate a moving screen saver program when you leave your monitor unattended. Always activate a periodic screen refresh application if your LCD monitor will display unchanging static content. Uninterrupted display of still or static images over an extended period may cause “burn in”, also known as “after-imaging” or “ghost imaging”, on your screen. “Burn-in”, “after-imaging”, or “ghost imaging” is a well-known phenomenon in LCD panel technology. In most cases, the “burned in” or “after-imaging” or “ghost imaging” will disappear gradually over a period of time after the power has been switched off.

**WARNING:** *Severe “burn-in” or “after-image” or “ghost image” symptoms will **not** disappear and **cannot** be repaired. The damage mentioned above is not covered under your warranty.*

#### **Service:**

- The casing cover should be opened only by qualified service personnel.
- If there is any need for any document for repair or integration, please contact with your local service center. (please refer to the chapter of “Consumer Information Center”)
- For transportation information, please refer to “Physical Specifications”.
- Do not leave your monitor in a car/trunk under direct sun light.



Consult a service technician if the monitor does not operate normally, or you are not sure what procedure to take when the operating instructions given in this manual have been followed.

[RETURN TO TOP OF THE PAGE](#)

[Safety and Troubleshooting](#)[General FAQs](#)[Compatibility with Other Peripherals](#)[LCD Panel Technology](#)[Ergonomics, Ecology and Safety Standards](#)[Troubleshooting](#)[Regulatory Information](#)

## FAQs (Frequently Asked Questions)

---

### General FAQs

**Q1: When I install my monitor what should I do if the screen shows 'Cannot display this video mode'?**

**A: Recommended resolution for Philips 22": 1680x1050 @60Hz.**

1. Unplug all cables, then connect your PC to the monitor that you used previously.
  2. In the Windows Start Menu, select Settings/Control Panel. In the Control Panel Window, select the Display icon. Inside the Display Control Panel, select the 'Settings' tab. Under the setting tab, in box labeled 'desktop area', move the sidebar to 1680x1050 pixels (22").
  3. Open 'Advanced Properties' and set the Refresh Rate to 60Hz, then click OK.
  4. Restart your computer and repeat step 2 and 3 to verify that your PC is set at 1680x1050@60Hz (22").
  5. Shut down your computer, disconnect your old monitor and reconnect your Philips LCD monitor.
  6. Turn on your monitor and then turn on your PC.
- 

**Q2: What does the recommended refresh rate for LCD monitor?**

**A:** Recommended refresh rate in LCD monitors is 60Hz, In case of any disturbance on screen, you can set it up to 75Hz to see if that removes the disturbance.

---

**Q3: What are the .inf and .icm files on the CD-ROM? How do I install the drivers (.inf and .icm)?**

**A:** These are the driver files for your monitor. Follow the instructions in your user manual to install the drivers. Your computer may ask you for monitor drivers (.inf and .icm files) or a driver disk when you first install your monitor. Follow the instructions to insert the ( companion CD-ROM) included in this package. Monitor drivers (.inf and .icm files) will be installed automatically.

---

**Q4: How do I adjust the resolution?**

**A:** Your video card/graphic driver and monitor together determine the available resolutions. You can select the desired resolution under Windows® Control Panel with the "Display properties".

---

**Q5: What if I get lost when I am making monitor adjustments?**

**A:** Simply press the OK button, then select 'Reset' to recall all of the original factory settings.

---

**Q6: Will the LCD screen be resistant to scratches?**

**A:** In general it is recommended that the panel surface is not subjected to excessive shocks and is protected from sharp or blunt objects. When handling the monitor, make sure that there is no pressure or force applied to the panel surface side. This may affect your warranty conditions.

---

**Q7: How should I clean the LCD surface?**

**A:** For normal cleaning, use a clean, soft cloth. For extensive cleaning, please use isopropyl alcohol. Do not use other solvents such as ethyl alcohol, ethanol, acetone, hexane, etc.

---

**Q8: Can I change the color setting of my monitor?**

**A:** Yes, you can change your color setting through OSD control as the following procedures,

1. Press "OK" to show the OSD (On Screen Display) menu
2. Press "Down Arrow" to select the option "Color" then press "OK" to enter color setting, there are three settings as below.

- a. Color Temperature; The six settings are 5000K, 6500K, 7500K, 8200K, 9300K and 11500K. With settings in the 5000K range the panel appears 'warm,' with a red-white color tone, while a 11500K temperature yields 'cool,

blue-white toning."

b. sRGB; this is a standard setting for ensuring correct exchange of colors between different device (e.g. digital cameras, monitors, printers, scanners, etc)

c. User Define; the user can choose his/her preference color setting by adjusting red, green blue color.

\*A measurement of the color of light radiated by an object while it is being heated. This measurement is expressed in terms of absolute scale, (degrees Kelvin). Lower Kevin temperatures such as 2004K are red; higher temperatures such as 9300K are blue. Neutral temperature is white, at 6504K.

---

**Q9: Can the Philips LCD Monitor be mounted on the wall?**

**A:** Yes. Philips LCD monitors have this optional feature. For standard VESA mount holes on the rear cover allows the user to mount the Philips monitor on most of the VESA standard arms or accessories. We recommend to contact your Philips sales representative for more information.

[RETURN TO TOP OF THE PAGE](#)

---

**Compatibility with other Peripherals**

**Q10: Can I connect my LCD monitor to any PC, workstation or Mac?**

**A:** Yes. All Philips LCD monitors are fully compatible with standard PCs, Macs and workstations. You may need a cable adapter to connect the monitor to your Mac system. Please contact your Philips sales representative for more information.

---

**Q11: Are Philips LCD monitors Plug-and-Play?**

**A:** Yes, the monitors are Plug-and-Play compatible with Windows® 95, 98, 2000, XP, Vista and Linux.

---

[RETURN TO TOP OF THE PAGE](#)

---

## LCD Panel Technology

### Q12: What kind of wide-angle technology is available?

**A:** Currently, the IPS type panels offer the best Contrast Ratio, compared to MVA, or PVA technologies. TN panels have improved over the years, but still cannot match the Contrast Ratio offered by IPS panel.

---

[RETURN TO TOP OF THE PAGE](#)

---

## Ergonomics, Ecology and Safety Standards

### Q13: What is Image Sticking, or Image Burn-in, or After Image, or Ghost Image in LCD panels?

**A:** Uninterrupted display of still or static images over an extended period may cause "burn in", also known as "after-imaging" or "ghost imaging", on your screen. "Burn-in", "after-imaging", or "ghost imaging" is a well-known phenomenon in LCD panel technology. In most cases, the "burned in" or "after-imaging" or "ghost imaging" will disappear gradually over a period of time after the power has been switched off.

Always activate a moving screen saver program when you leave your monitor unattended.

Always activate a periodic screen refresh application if your LCD monitor will display unchanging static content.

**WARNING:** Severe "burn-in" or "after-image" or "ghost image" symptoms will **not** disappear and **cannot** be repaired. The damage mentioned above is not covered under your warranty.

### Q14: Why is my Display not showing sharp text, and is displaying jagged characters?

**A:** Your LCD monitor works best at its native resolution of 1680x1050@60Hz. For best display please use this resolution.

---

[RETURN TO TOP OF THE PAGE](#)

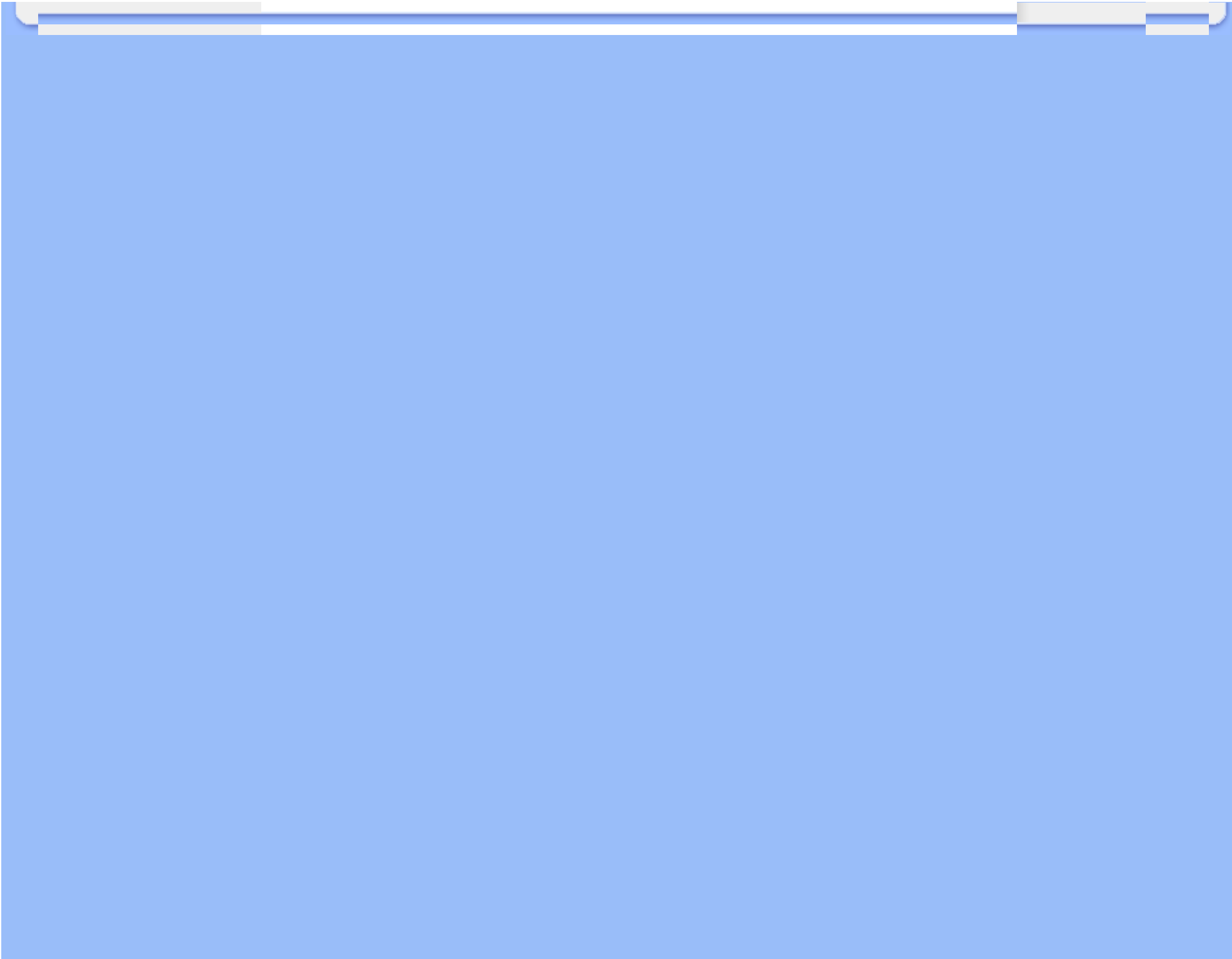



Safety and  
Troubleshooting  
FAQs

Common Problems



Imaging Problems

Regulatory Information

## Troubleshooting

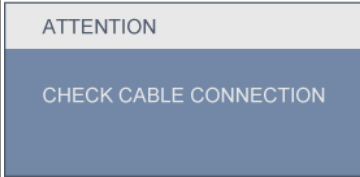
This page deals with problems that can be corrected by a user. If the problem still persists after you have tried these solutions, contact Philips customer service representative.

Common Problems	
Having this problem	Check these items
No Picture (Power LED not lit)	<ul style="list-style-type: none"> <li>● Make sure the power cord is plugged into the power outlet and into the back of the monitor.</li> <li>● First, ensure that the power button on the front of the monitor is in the OFF position, then press it to the ON position.</li> </ul>
No Picture (Power LED is white blinking)	<ul style="list-style-type: none"> <li>● Make sure the computer is turned on.</li> <li>● Make sure the signal cable is properly connected to your computer.</li> <li>● make sure the monitor cable has no bent pins on the connect side. If yes, repair or replace the cable.</li> <li>● The Energy Saving feature may be activated</li> </ul>
Screen says  	<ul style="list-style-type: none"> <li>● Make sure the monitor cable is properly connected to your computer. (Also refer to the Quick Set-Up Guide).</li> <li>● Check to see if the monitor cable has bent pins.</li> <li>● Make sure the computer is turned on.</li> </ul>
AUTO button doesn't function in VGA mode	<ul style="list-style-type: none"> <li>● The auto function is applicable only in VGA-Analog mode. If the result is not satisfactory, you can do manual adjustments via the OSD menu. Note that the Auto Function is not applicable in DVI-Digital mode as it is not necessary.</li> </ul>
Imaging Problems	
Image is not centered	<ul style="list-style-type: none"> <li>● Press the Auto button.</li> <li>● Adjust the image position using the Phase/Clock of Setup in OSD Main Controls.</li> </ul>

<p>Image vibrates on the screen</p>	<ul style="list-style-type: none"> <li>● Check that the signal cable is properly securely connected to the graphics board or PC.</li> </ul>
<p>Vertical flicker appears</p> 	<ul style="list-style-type: none"> <li>● Press the Auto button.</li> <li>● Eliminate the vertical bars using the Phase/Clock of Setup in OSD Main Controls.</li> </ul>
<p>Horizontal flicker appears</p> 	<ul style="list-style-type: none"> <li>● Press the Auto button.</li> <li>● Eliminate the vertical bars using the Phase/Clock of Setup in OSD Main Controls.</li> </ul>
<p>image appears blurred, indistinct or too dark</p>	<ul style="list-style-type: none"> <li>● Adjust the contrast and brightness on On-Screen Display.</li> </ul>
<p>An "after-image", "burn-in" or "ghost image" remains after the power has been turned off.</p>	<ul style="list-style-type: none"> <li>● Uninterrupted display of still or static images over an extended period may cause "burn in", also known as "after-imaging" or "ghost imaging", on your screen. "Burn-in", "after-imaging", or "ghost imaging" is a well-known phenomenon in LCD panel technology. In most cases, the "burned in" or "after-imaging" or "ghost imaging" will disappear gradually over a period of time after the power has been switched off.</li> <li>● Always activate a moving screen saver program when you leave your monitor unattended.</li> <li>● Always activate a periodic screen refresh application if your LCD monitor will display unchanging static content.</li> </ul>
<p>Image appears distorted. Text is fuzzy or blurred.</p>	<ul style="list-style-type: none"> <li>● Set the PC's display resolution to the same mode as monitor's recommended screen native resolution.</li> </ul>
<p>Green, red, blue, dark, and white dots appears on the screen</p>	<ul style="list-style-type: none"> <li>● The remaining dots are normal characteristic of the liquid crystal used in today s technology, <a href="#">Pls refer the pixel policy for more detail.</a></li> </ul>

The "power on" light is too strong to disturb me.

- You can adjust "power on" light using the power LED of Setup in OSD main Controls.

For further assistance, refer to the [Consumer Information Centers](#) list and contact Philips customer service representative.

[RETURN TO TOP OF THE PAGE](#)

[TCO Displays 5.0 Information](#)

[Recycling Information for Customers](#)

[Waste Electrical and Electronic  
Equipment-WEEE](#)

[CE Declaration of Conformity](#)

[Energy Star Declaration](#)

[Federal Communications  
Commission \(FCC\) Notice \(U.S.  
Only\)](#)

[FCC Declaration of Conformity](#)

[Commission Federale de la  
Communication \(FCC Declaration\)  
EN 55022 Compliance \(Czech  
Republic Only\)](#)

[Polish Center for Testing and  
Certification Notice](#)

[North Europe \(Nordic Countries\)  
Information](#)

[BSMI Notice \(Taiwan Only\)](#)

[Ergonomie Hinweis \(nur  
Deutschland\)](#)

[Philips End-of-Life Disposal](#)

[China RoHS](#)

[Lead-free Product](#)

[Troubleshooting](#)

[Other Related Information](#)

[Frequently Asked Questions \(FAQs\)](#)

## Regulatory Information

Available for selective models

### TCO Displays 5.0 Information



**Congratulations,  
Your display is designed for both you and the planet!**

This display carries the TCO Certified label. This ensures that the display is designed for minimal impact on the climate and natural environment, while offering all the performance expected from top of the line electronic products. TCO Certified is a third party verified program, where every product model is tested by an accredited independent test laboratory. TCO Certified represents one of the toughest certifications for displays worldwide.

#### Some of the Usability features of the TCO Displays 5.0 requirements:

##### *Visual Ergonomics*

Good visual ergonomics in order to improve the working environment for the user and to reduce sight and strain problems. Important parameters are:

- Light levels without color tint, Uniform color and luminance, Wide color gamut
- Calibrated color temperature and gamma curve
- Wide luminance level, Dark black levels, Low motion blur

##### *Electrical Safety*

- Product fulfills rigorous safety standards

##### *Emissions*

- Low alternating electric and magnetic fields emissions
- Low acoustic noise emissions

#### Some of the Environmental features of the TCO Displays 5.0 requirements:

- The brand owner demonstrates corporate social responsibility and has a certified environmental management system (EMAS or ISO 14001)
- Very low energy consumption both in on- and standby mode
- Restrictions on chlorinated and brominated flame retardants, plasticizer and polymers
- Restrictions on heavy metals such as cadmium, mercury and lead (RoHS compliance)
- Both product and product packaging is prepared for recycling
- The brand owner offers take-back options

The requirements included in this label have been developed by TCO Development in co-operation with scientists, experts, users as well as manufacturers all over the world. Since the end of the 1980s TCO has been involved in influencing the development of IT equipment in a more user-friendly direction. Our labeling system started with displays in 1992 and is now requested by users and IT-manufacturers all over the world.

For more information, please visit [www.tcodevelopment.com](http://www.tcodevelopment.com)



Technology for you and the planet

[RETURN TO TOP OF THE PAGE](#)

---

### Recycling Information for Customers

There is currently a system of recycling up and running in the European countries, such as The Netherlands, Belgium, Norway, Sweden and Denmark.

In Asia Pacific, Taiwan, the products can be taken back by Environment Protection Administration (EPA) to follow the IT product recycling management process, detail can be found in web site [www.epa.gov.tw](http://www.epa.gov.tw)

The monitor contains parts that could cause damage to the nature environment. Therefore, it is vital that the monitor is recycled at the end of its life cycle.

For help and service, please contact [Consumers Information Center](#) or [F1rst Choice Contact Information Center](#) in each country.

[RETURN TO TOP OF THE PAGE](#)

---

### Waste Electrical and Electronic Equipment-WEEE

Attention users in European Union private households



This marking on the product or on its packaging illustrates that, under European Directive 2002/96/EC governing used electrical and electronic appliances, this product may not be disposed of with normal household waste. You are responsible for disposal of this equipment through a designated waste electrical and electronic equipment collection. To determine the locations for dropping off such waste electrical and electronic, contact your local government office, the waste disposal organization that serves your household or the store at which you purchased the product.

Attention users in United States:

Like all LCD products, this set contains a lamp with Mercury. Please dispose of according to all Local, State and Federal laws. For the disposal or recycling information, contact [www.mygreenelectronics.com](http://www.mygreenelectronics.com) or [www.eiae.org](http://www.eiae.org).

[RETURN TO TOP OF THE PAGE](#)

---



#### EPEAT

"The EPEAT (Electronic Product Environmental Assessment Tool) program evaluates computer desktops, laptops, and monitors based on 51 environmental criteria developed through an extensive stakeholder consensus process supported by US EPA.

EPEAT system helps purchasers in the public and private sectors evaluate, compare and select desktop computers, notebooks and monitors based on their environmental attributes. EPEAT also provides a clear and consistent set of performance criteria for the design of products, and provides an opportunity for manufacturers to secure market recognition for efforts to reduce the environmental impact of its products."

#### Benefits of EPEAT

Reduce use of primary materials

Reduce use of toxic materials

Avoid the disposal of hazardous waste EPEAT'S requirement that all registered products meet ENERGY STAR's energy efficiency specifications, means that these products will consume less energy throughout their life.

[RETURN TO TOP OF THE PAGE](#)

---

ROHS is a European Directive aiming to control the use of certain hazardous substances in the production of new electrical and electronic equipment. Philips has completely eliminated four of six RoHS-banned substances from its products by 1998-eight full years before compliance was required and has lowered usage of the remaining substances significantly below the mandated levels.

[RETURN TO TOP OF THE PAGE](#)

---

#### CE Declaration of Conformity

This product is in conformity with the following standards

- EN60950-1:2001 (Safety requirement of Information Technology Equipment)
- EN55022:2006 (Radio Disturbance requirement of Information Technology Equipment)
- EN55024:1998 (Immunity requirement of Information Technology Equipment)
- EN61000-3-2:2006 (Limits for Harmonic Current Emission)
- EN61000-3-3:1995 (Limitation of Voltage Fluctuation and Flicker)

following provisions of directives applicable

- 2006/95/EC (Low Voltage Directive)
- 2004/108/EC (EMC Directive)

and is produced by a manufacturing organization on ISO9000 level.

The product also comply with the following standards

- ISO13406-2 (Ergonomic requirement for Flat Panel Display)
- GS EK1-2000 (GS specification)
- prEN50279:1998 (Low Frequency Electric and Magnetic fields for Visual Display)
- MPR-II (MPR:1990:8/1990:10 Low Frequency Electric and Magnetic fields)
- TCO'03, TCO Displays 5.0 (Requirement for Environment Labelling of Ergonomics, Energy, Ecology and Emission,
- TCO: Swedish Confederation of Professional Employees) for TCO versions

[RETURN TO TOP OF THE PAGE](#)

### Energy Star Declaration

This monitor is equipped with a function for saving energy which supports the VESA Display Power Management Signaling (DPMS) standard. This means that the monitor must be connected to a computer which supports VESA DPMS. Time settings are adjusted from the system unit by software.

	VESA State	LED Indicator	Power Consumption
Normal operation	ON (Active)	White	< 24 W (typ.)
Power Saving Alternative 2 One step	Sleep	White Blinking	< 0.8 W (typ.)
	Switch Off	Off	< 0.5 W (typ.)



As an ENERGY STAR® Partner, we have determined that this product meets the ENERGY STAR® guidelines for energy efficiency.



We recommend you switch off the monitor when it is not in use for a long time.

[RETURN TO TOP OF THE PAGE](#)

### Federal Communications Commission (FCC) Notice (U.S. Only)



This equipment has been tested and found to comply with the limits for a Class B digital device, pursuant to Part 15 of the FCC Rules. These limits are designed to provide reasonable protection against harmful interference in a residential installation. This equipment generates, uses and can radiate radio frequency energy and, if not installed and used in accordance with the instructions, may cause harmful interference to radio communications. However, there is no guarantee that interference will not occur in a particular installation. If this equipment does cause harmful interference to radio or television reception, which can be determined by turning the equipment off and on, the user is encouraged to try to correct the interference by one or more of the following measures:

- Reorient or relocate the receiving antenna.
- Increase the separation between the equipment and receiver.
- Connect the equipment into an outlet on a circuit different from that to which the receiver is connected.
- Consult the dealer or an experienced radio/TV technician for help.



Changes or modifications not expressly approved by the party responsible for compliance could void the user's authority to operate the equipment.

Use only RF shielded cable that was supplied with the monitor when connecting this monitor to a computer device.

To prevent damage which may result in fire or shock hazard, do not expose this appliance to rain or excessive moisture.

THIS CLASS B DIGITAL APPARATUS MEETS ALL REQUIREMENTS OF THE CANADIAN INTERFERENCE-CAUSING EQUIPMENT REGULATIONS.

[RETURN TO TOP OF THE PAGE](#)

---

### FCC Declaration of Conformity

Declaration of Conformity for Products Marked with FCC Logo,  
United States Only



This device complies with Part 15 of the FCC Rules. Operation is subject to the following two conditions: (1) this device may not cause harmful interference, and (2) this device must accept any interference received, including interference that may cause undesired operation.

[RETURN TO TOP OF THE PAGE](#)

---

### Commission Federale de la Communication (FCC Declaration)



Cet équipement a été testé et déclaré conforme aux limites des appareils numériques de class B, aux termes de l'article 15 Des règles de la FCC. Ces limites sont conçues de façon à fournir une protection raisonnable contre les interférences nuisibles dans le cadre d'une installation résidentielle. CET appareil produit, utilise et peut émettre des hyperfréquences qui, si l'appareil n'est pas installé et utilisé selon les consignes données, peuvent causer des interférences nuisibles aux communications radio. Cependant, rien ne peut garantir l'absence d'interférences dans le cadre d'une installation particulière. Si cet appareil est la cause d'interférences nuisibles pour la réception des signaux de radio ou de télévision, ce qui peut être décelé en fermant l'équipement, puis en le remettant en fonction, l'utilisateur pourrait essayer de corriger la situation en prenant les mesures suivantes:

- Réorienter ou déplacer l'antenne de réception.
- Augmenter la distance entre l'équipement et le récepteur.
- Brancher l'équipement sur un autre circuit que celui utilisé par le récepteur.
- Demander l'aide du marchand ou d'un technicien chevronné en radio/télévision.



Toutes modifications n'ayant pas reçu l'approbation des services compétents en matière de conformité est susceptible d'interdire à l'utilisateur l'usage du présent équipement.



N'utiliser que des câbles RF armés pour les connections avec des ordinateurs ou périphériques.

CET APPAREIL NUMERIQUE DE LA CLASSE B RESPECTE TOUTES LES EXIGENCES DU REGLEMENT SUR LE MATERIEL BROUILLEUR DU CANADA.

[RETURN TO TOP OF THE PAGE](#)

---

### EN 55022 Compliance (Czech Republic Only)

This device belongs to category B devices as described in EN 55022, unless it is specifically stated that it is a Class A device on the specification label. The following applies to devices in Class A of EN 55022 (radius of protection up to 30 meters). The user of the device is obliged to take all steps necessary to remove sources of interference to telecommunication or other devices.

Pokud není na typovém štítku počítače uvedeno, že spadá do do třídy A podle EN 55022, spadá automaticky do třídy B podle EN 55022. Pro zařízení zařazená do třídy A (chranné pásmo 30m) podle EN 55022 platí následující. Dojde-li k rušení telekomunikačních nebo jiných zařízení je uživatel povinen provést taková opatření, aby rušení odstranil.

[RETURN TO TOP OF THE PAGE](#)

---

### Polish Center for Testing and Certification Notice

The equipment should draw power from a socket with an attached protection circuit (a three-prong socket). All equipment that works together (computer, monitor, printer, and so on) should have the same power supply source.

The phasing conductor of the room's electrical installation should have a reserve short-circuit protection device in the form of a fuse with a nominal value no larger than 16 amperes (A).

To completely switch off the equipment, the power supply cable must be removed from the power supply socket, which should be located near the equipment and easily accessible.

A protection mark "B" confirms that the equipment is in compliance with the protection usage requirements of standards PN-93/T-42107 and PN-89/E-06251.

### ***Wymagania Polskiego Centrum Badań i Certyfikacji***

Urządzenie powinno być zasilane z gniazda z przyłączonym obwodem ochronnym (gniazdo z kołkiem). Współpracujące ze sobą urządzenia (komputer, monitor, drukarka) powinny być zasilane z tego samego źródła.

Instalacja elektryczna pomieszczenia powinna zawierać w przewodzie fazowym rezerwową ochronę przed zwarciami, w postaci bezpiecznika o wartości znamionowej nie większej niż 16A (amperów).

W celu całkowitego wyłączenia urządzenia z sieci zasilania, należy wyjąć wtyczkę kabla zasilającego z gniazdka, które powinno znajdować się w pobliżu urządzenia i być łatwo dostępne.

Znak bezpieczeństwa "B" potwierdza zgodność urządzenia z wymaganiami bezpieczeństwa użytkownika zawartymi w PN-93-T-42107 i PN-89:E-06251.

### ***Pozostałe instrukcje bezpieczeństwa***

- Nie należy używać wtyczek adapterowych lub usuwać kołka obwodu ochronnego z wtyczki. Jeżeli konieczne jest użycie przedłużacza to należy użyć przedłużacza 3-żyłowego z prawidłowo połączonym przewodem ochronnym.
- System komputerowy należy zabezpieczyć przed nagłymi, chwilowymi wzrostami lub spadkami napięcia, używając eliminatora przepięć, urządzenia dopasowującego lub bezakłóceniewego źródła zasilania.
- Należy upewnić się, aby nic nie leżało na kablach systemu komputerowego, oraz aby kable nie były umieszczone w miejscu, gdzie można byłoby na nie nadeptywać lub potykać się o nie.
- Nie należy rozlewać napojów ani innych płynów na system komputerowy.
- Nie należy wpychać żadnych przedmiotów do otworów systemu komputerowego, gdyż może to spowodować pożar lub porażenie prądem, poprzez zwarcie elementów wewnętrznych.
- System komputerowy powinien znajdować się z dala od grzejników i źródeł ciepła. Ponadto, nie należy blokować otworów wentylacyjnych. Należy unikać kładzenia luźnych papierów pod komputer oraz umieszczenia komputera w ciasnym miejscu bez możliwości cyrkulacji powietrza wokół niego.

[RETURN TO TOP OF THE PAGE](#)

## **North Europe (Nordic Countries) Information**

Placering/Ventilation

### **VARNING:**

FÖRSÄKRA DIG OM ATT HUVUDBRYTARE OCH UTTAG ÄR LÄTÅTKOMLIGA, NÄR DU STÄLLER DIN UTRUSTNING PÅPLATS.

Placering/Ventilation

### **ADVARSEL:**

SØRG VED PLACERINGEN FOR, AT NETLEDNINGENS STIK OG STIKKONTAKT ER NEMT TILGÆNGELIGE.

Paikka/Ilmankierto

### **VAROITUS:**

SIJOITA LAITE SITEN, ETTÄ VERKKOJOHTO VOIDAAN TARVITTAESSA HELPOSTI IRROTTAA PISTORASIESTA.

Plassering/Ventilasjon

**ADVARSEL:**

NÅR DETTE UTSTYRET PLASSERES, MÅ DU PASSE PÅ AT KONTAKTENE FOR STØMTILFØRSEL ER LETTE Å NÅ.

[RETURN TO TOP OF THE PAGE](#)

---

**BSMI Notice (Taiwan Only)**

符合乙類資訊產品之標準

[RETURN TO TOP OF THE PAGE](#)

---

**Ergonomie Hinweis (nur Deutschland)**

Der von uns gelieferte Farbmonitor entspricht den in der "Verordnung über den Schutz vor Schäden durch Röntgenstrahlen" festgelegten Vorschriften.

Auf der Rückwand des Gerätes befindet sich ein Aufkleber, der auf die Unbedenklichkeit der Inbetriebnahme hinweist, da die Vorschriften über die Bauart von Störstrahlern nach Anlage III  $\alpha$  5 Abs. 4 der Röntgenverordnung erfüllt sind.

Damit Ihr Monitor immer den in der Zulassung geforderten Werten entspricht, ist darauf zu achten, daß

1. Reparaturen nur durch Fachpersonal durchgeführt werden.
2. nur original-Ersatzteile verwendet werden.
3. bei Ersatz der Bildröhre nur eine bauartgleiche eingebaut wird.

Aus ergonomischen Gründen wird empfohlen, die Grundfarben Blau und Rot nicht auf dunklem Untergrund zu verwenden (schlechte Lesbarkeit und erhöhte Augenbelastung bei zu geringem Zeichenkontrast wären die Folge).

Der arbeitsplatzbezogene Schalldruckpegel nach DIN 45 635 beträgt 70dB (A) oder weniger.



**ACHTUNG: BEIM AUFSTELLEN DIESES GERÄTES DARAUFGAHTEN, DAß NETZSTECKER UND NETZKABELANSCHLUß LEICHT ZUGÄNGLICH SIND.**

[RETURN TO TOP OF THE PAGE](#)

---

**End-of-Life Disposal**

Your new monitor contains materials that can be recycled and reused. Specialized companies can recycle your product to increase the amount of reusable materials and to minimize the amount to be disposed of.

Please find out about the local regulations on how to dispose of your old monitor from your sales representative.

**(For customers in Canada and U.S.A.)**

This product may contain lead and/or mercury. Dispose of in accordance to local-state and federal regulations. For additional information on recycling contact [www.eia.org](http://www.eia.org) (Consumer Education Initiative)

[RETURN TO TOP OF THE PAGE](#)

## China RoHS

The People's Republic of China released a regulation called "Management Methods for Controlling Pollution by Electronic Information Products" or commonly referred to as China RoHS. All products including CRT and LCD monitor which are produced and sold for China market have to meet China RoHS request.

### 中国大陆RoHS

根据中国大陆《电子信息产品污染控制管理办法》（也称为中国大陆RoHS），以下部分列出了本产品中可能包含的有毒有害物质或元素的名称和含量

#### 本表适用之产品

显示器（液晶及CRT）

#### 有毒有害物质或元素

部件名称	有毒有害物质或元素					
	铅 (Pb)	汞 (Hg)	镉 (Cd)	六价铬 (Cr6+)	多溴联苯 (PBB)	多溴二苯醚 (PBDE)
外壳	○	○	○	○	○	○
CRT显示屏	×	○	○	○	○	○
液晶显示屏/灯管	×	×	○	○	○	○
电路板组件*	×	○	○	○	○	○
电源适配器	×	○	○	○	○	○
电源线/连接线	×	○	○	○	○	○

\*：电路板组件包括印刷电路板及其构成的零部件，如电阻、电容、集成电路、连接器等  
 ○：表示该有毒有害物质在该部件所有均质材料中的含量均在《电子信息产品中有毒有害物质的限量要求标准》规定的限量要求以下  
 ×：表示该有毒有害物质至少在该部件的某一均质材料中的含量超出《电子信息产品中有毒有害物质的限量要求标准》规定的限量要求；但是上表中打“×”的部件，符合欧盟RoHS法规要求（属于豁免的部分）



环保使用期限

此标识指期限(十年),电子信息产品中含有的有毒有害物质或元素在正常使用的条件下不会发生外泄或突变,电子信息产品用户使用该电子信息产品不会对环境造成严重污染或对其人身、财产造成严重损害的期限。

## 中国能源效率标识

根据中国大陆《能源效率标识管理办法》本显示器符合以下要求：

能源效率(cd/W)	> 1.05
能效等级	1 级
能效标准	GB 21520-2008

详细有关信息请查阅中国能效标识网：<http://www.energylabel.gov.cn/>

[RETURN TO TOP OF THE PAGE](#)

---

## Lead-free Product



Philips eliminated toxic substances like lead from its displays. Lead-free display helps protect your health and promotes environmentally sound recovery and disposal of waste from electrical and electronic equipment. PHILIPS Brand designs and produces display products in compliance with strict Restriction of Hazardous Substances (RoHS) european legislation that restrict lead and other toxic.

[RETURN TO TOP OF THE PAGE](#)

---

[About This Guide](#)

[Notational Descriptions](#)

## About This Manual

---

### About This Guide

This electronic user's guide is intended for anyone who uses the Philips LCD Monitor. It describes the LCD monitor's features, setup, operation and other important information. Its contents are identical to the information in our printed version.

It includes the following sections:

- [Safety and Troubleshooting Information](#) provides tips and solutions for common problems as well as other related information you may need.
- About This Electronic User's Manual gives an overview of information included, along with notation icon descriptions and other documentation for your reference.
- [Product Information](#) gives an overview of the monitor's features as well as the technical specifications for this monitor.
- [Installing Your Monitor](#) describes the initial setup process and gives an overview of how to use the monitor.
- [On-Screen Display](#) provides information on adjusting the settings on your monitor.
- [Customer Care and Warranty](#) contains a list of worldwide Philips Consumer Information Centers along with help desk phone numbers and information on the warranty applicable to your product.
- [Glossary](#) defines technical terms.
- [Download and Print Option](#) transfers this entire manual to your hard drive for easy reference.

[RETURN TO TOP OF THE PAGE](#)

---

### Notational Descriptions

The following subsections describe notational conventions used in this document.

### Notes, Cautions and Warnings

Throughout this guide, blocks of text may be accompanied by an icon and printed in bold or italic type. These blocks contain notes, cautions or warnings. They are used as follows:



**NOTE:** This icon indicates important information and tips that help you make better use of your computer system.



**CAUTION:** This icon indicates information that tells you how to avoid either potential damage to hardware or loss of data.



**WARNING:** This icon indicates the potential for bodily harm and tells you how to avoid the problem.

Some warnings may appear in alternate formats and may not be accompanied by an icon. In such cases, the specific presentation of the warning is mandated by the relevant regulatory authority.

[RETURN TO TOP OF THE PAGE](#)

- Your LCD Monitor
- SmartImage
- SmartContrast
- SmartSaturate
- SmartSharpness
- Technical Specifications
- Resolution & Preset Modes
- Philips Pixel Defect Policy
- Automatic Power Saving
- Product Views
- Physical Function
- SmartControl II

## Product Information

---

### Your LCD monitor

Congratulations on your purchase and welcome to Philips. To fully benefit from the support that Philips offers, register your product at. [www.philips.com/welcome](http://www.philips.com/welcome)

---

### SmartImage

#### What is it?

SmartImage provides presets that optimize display for different types of content, dynamically adjusting brightness, contrast, color and sharpness in real time. Whether you're working with text applications, displaying images or watching a video, Philips SmartImage delivers great optimized LCD display performance.

#### Why do I need it?

You want a LCD display that delivers optimized display all your favorite types of content, SmartImage software dynamically adjust brightness, contrast, color and sharpness in real time to enhance your LCD viewing experience.



#### How does it work?

SmartImage is an exclusive, leading edge Philips technology that analyzes the content displayed on your screen. Based on a scenario you select, SmartImage dynamically enhances the contrast, color saturation and sharpness of images and videos for ultimate display performance - all in real time with the press on a single button.

#### How to enable SmartImage?

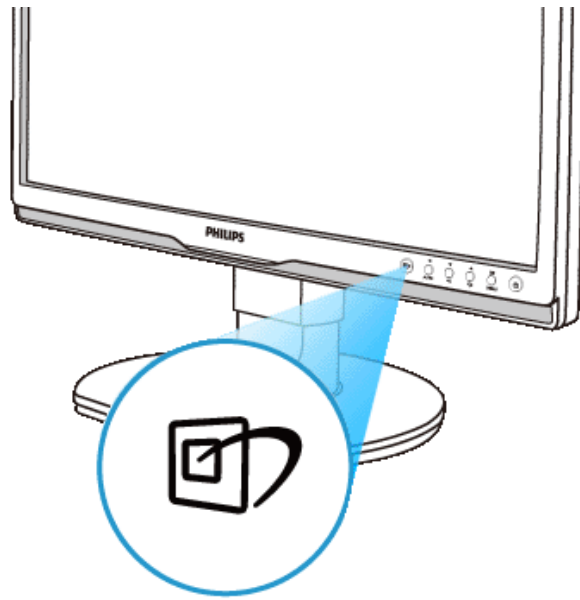



1. Press to  launch the SmartImage on screen display;
2. Keep press  to toggle between Office Work, Image Viewing, Entertainment, Economy, and Off;
3. The SmartImage on screen display will remain on screen for 5 seconds or you can also press "OK" to make confirmation.
4. When SmartImage is enabled, the sRGB scheme is disabled automatically. To use sRGB you need to disable SmartImage with the  button at the front bezel of your monitor.

Except using  key to scroll down, you can also press ▼▲ buttons to choose and press "OK" to confirm selection and close the SmartImage OSD. There are five modes to be selected: Office Work, Image Viewing, Entertainment, Economy, and Off.

There are five modes to be selected: Office Work, Image Viewing, Entertainment, Economy, and Off.

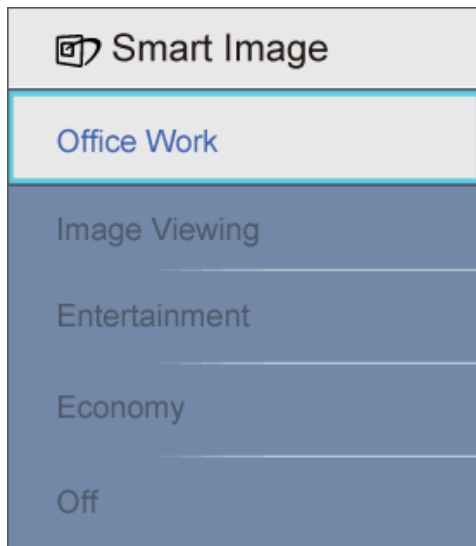

1. **Office Work:** Enhances text and dampens brightness to increase readability and reduce eye strain. This mode significantly enhances readability and productivity when you're working with spreadsheets, PDF files, scanned articles or other general office applications.
2. **Image Viewing:** This profile combines color saturation, dynamic contrast and sharpness enhancement to display photos and other images with outstanding clarity in vibrant colors - all without artifacts and faded colors.
3. **Entertainment:** Ramped up luminance, deepened color saturation, dynamic contrast and razor sharpness displays every details in darker areas of your videos without color washout in brighter areas maintaining a dynamic natural values for the ultimate video display.
4. **Economy:** Under this profile, brightness, contrast are adjusted and backlighting fine-tuned for just right display of everyday office applications and lower power consumption.
5. **Off:** No optimization by SmartImage.

[RETURN TO TOP OF THE PAGE](#)

---

## SmartContrast

### What is it?

Unique technology that dynamically analyzes displayed content and automatically optimizes a LCD monitor's contrast ratio for maximum visual clarity and viewing enjoyment, stepping up backlighting for clearer, crisper and brighter images or dimming backlighting for clear display of images on dark backgrounds.

### Why do I need it?

You want the very best visual clarity and viewing comfort for every type of content. SmartContrast dynamically controls contrast and adjusts backlighting for clear, crisp, bright gaming and video images or displays clear, readable text for office work. By reducing your monitor's power consumption, you save on energy costs and extend the lifetime of your monitor.

### How does it work?

When you active SmartContrast which will analysis the content you are displaying in real time to adjust colors and

control backlight intensity. This function can obviously enhance contrast in dynamic for more entertainment fun when viewing videos or playing games.

[RETURN TO TOP OF THE PAGE](#)

---

## SmartSaturate

### What is it?

Smart technology that controls color saturation - the degree to which one on screen color is diluted by neighboring colors - to deliver rich and vibrant images for more entertainment fun when you are viewing videos.

### Why do I need it?

You want rich, vibrant images for more entertainment fun when viewing photos or videos.

### How does it work?

SmartSaturate dynamically controls color saturation - the degree to which on-screen color is diluted by neighboring colors - to deliver rich, vibrant display for more entertainment fun when you are viewing images or videos in your display's Entertainment mode and is turned off for top quality display of office application and in the Economy mode to reduce power consumption.

[RETURN TO TOP OF THE PAGE](#)

---

## SmartSharpness

### What is it?

Smart technology that enhances sharpness when you need it for ultimate display performance and more entertainment fun when you are viewing videos or photos.

### Why do I need it?

You want the ultimate in sharpness for more entertainment fun when viewing photos or videos.

### How does it work?

Smart technology enhances sharpness when you need it for ultimate display performance and more entertainment fun when you are viewing videos or photos in the Entertainment mode and is turned off for top quality display of office applications and in the Economy mode to reduce power consumptions.

[RETURN TO TOP OF THE PAGE](#)

---

## Technical Specifications\*

<b>Picture/Display</b>	
LCD panel type	TFT-LCD
Panel size	22" W
Aspect ratio	16:10
Pixel Pitch	0.282 x 0.282 mm
Brightness	250 cd/m <sup>2</sup>
SmartContrast	25000:1
Contrast ratio (typ.)	1000:1
Response time (typical)	5 ms
Optimum Resolution	1680 x 1050 @ 60Hz
Viewing angle	176° (H) / 170° (V) @ C/R > 5
Picture Enhancement	Smartimage
Display colors	16.7 M
Vertical refresh rate	56Hz -76Hz
Horizontal Frequency	30kHz - 80kHz
sRGB	YES
<b>Connectivity</b>	
Signal input	DVI-D (digital, HDCP), VGA (Analog)
USB	USB 2.0 x 1
Input Signal	Separate Sync, Sync on Green
Audio In/Out	Stereo Audio
<b>Convenience</b>	
Built-in Audio	1.5 W x 2
User Convenience	Smartimage, Auto (Back), Input (Down), Brightness (UP) Menu (OK), Power On/Off
OSD Languages	English, French, German, Italian, Russian, Spanish, Simplified Chinese, Portuguese
Other convenience	VESA mount ( 100 x 100mm), Kensington lock
Plug & Play Compatibility	DDC/CI, sRGB, Windows 98/2000/XP/Vista, Mac OS X
<b>Stand</b>	
Tilt	-5/+20
Height adjustment	130mm (220P1), 70mm (220B1)
Swivel	-65/+65 (220P1), -45/+45 (220B1)

<b>Power</b>			
On mode	< 28.5 W (typ.), < 31 W (max)		
On mode (ECO mode) (typical)	< 21 W		
Energy Consumption (EnergyStar 5.0 test method)	AC Input Voltage at 100VAC +/-5VAC, 50Hz +/- 3Hz	AC Input Voltage at 115VAC +/-5VAC, 60Hz +/- 3Hz	AC Input Voltage at 230VAC +/-5VAC, 50Hz +/- 3Hz
Normal Operation (typical)	24 W	24 W	24 W
Sleep	0.8 W	0.8 W	0.8 W
Off	0.5 W	0.5 W	0.5 W
Heat Dissipation*	AC Input Voltage at 100VAC +/-5VAC, 50Hz +/- 3Hz	AC Input Voltage at 115VAC +/-5VAC, 60Hz +/- 3Hz	AC Input Voltage at 230VAC +/-5VAC, 50Hz +/- 3Hz
Normal Operation	81.91BTU/hr	81.91BTU/hr	81.91BTU/hr
Sleep	2.73BTU/hr	2.73BTU/hr	2.73BTU/hr
Off	1.7BTU/hr	1.7BTU/hr	1.7BTU/hr
Power LED indicator	On mode: White, Standby/Sleep mode: White (blinking)		
Power Supply	Build-in, 100-240VAC, 50/60Hz		
<b>Dimension</b>			
Product with stand (WxHxD)	502 x 589 x 220mm (220P1), 502 x 446 x 228mm (220B1)		
Product without stand (WxHxD)	502 x 346 x 58mm		
Box dimension (WxHxD)	658 x 410 x 272mm (220P1), 562 x 480 x 168mm (220B1)		
<b>Weight</b>			
Product with stand	6.4kg (220P1), 5.2kg (220B1)		
Product without stand	4.1kg		
Product with packaging	7.6kg (220P1), 6.9kg (220B1)		
<b>Operating Condition</b>			
Temperature range (operation)	0° C to 40 ° C		
Temperature range (operation)	-20° C to 60° C		
Relative humidity	20% to 80%		
Altitude	Non-operation: + 12,000 ft ( 3,658 m)		
	operation: + 40,000 ft ( 12,192 m),		
MTBF	50000 hrs		
<b>Environmental</b>			
ROHS	YES		
EPEAT	silver		

EnergyStar	5.0
Packaging	100% recyclable
<b>Compliance and standards</b>	
Regulatory Approvals	CE Mark, Energy Star 5.0, FCC Class B, SEMKO, TCO5.0, TÜV/GS, TÜV Ergo, UL/cUL
<b>Cabinet</b>	
Color	Black/Sliver, Black/Black
Finish	Texture

*\* This data is subject to change without notice.*

[RETURN TO TOP OF THE PAGE](#)

### Resolution & Preset Modes

#### A. Maximum Resolution

- For 220P1/220B1
  - 1680 x 1050 at 60 Hz (analog input)
  - 1680 x 1050 at 60 Hz (digital input)

#### B. Recommended Resolution

- For 220P1/220B1
  - 1680 x 1050 at 60 Hz (digital input)

#### 18 factory preset modes:

H. freq (kHz)	Resolution	V. freq (Hz)
31.469	640*350	70.086
31.469	720*400	70.087
31.469	640*480	59.940
35.000	640*480	67.000
37.500	640*480	75.000
35.156	800*600	56.250
37.879	800*600	60.317
46.875	800*600	75.000
48.363	1024*768	60.004
60.023	1024*768	75.029
63.981	1280*1024	60.020

79.976	1280*1024	75.025	
55.469	1440*900	59.901	
55.935	1440*900	59.887	
70.635	1440*900	74.984	
66.587	1920*1080	60.000	(reduce blinking)
65.290	1680*1050	60.000	
64.674	1680*1050	60.000	

[RETURN TO TOP OF THE PAGE](#)

### Automatic Power Saving

If you have VESA DPM compliance display card or software installed in your PC, the monitor can automatically reduce its power consumption when not in use. If an input from a keyboard, mouse or other input device is detected, the monitor will 'wake up' automatically. The following table shows the power consumption and signaling of this automatic power saving feature:

Power Management Definition					
VESA Mode	Video	H-sync	V-sync	Power Used	LED color
Active	ON	Yes	Yes	< 28.5 W (typ.) < 31 (max.)	White
Sleep	OFF	No	No	< 0.8 W (typ.)	White (Blinking)
Switch Off	OFF	-	-	< 0.5 W (typ.)	Off

This monitor is ENERGY STAR® compliant. As an ENERGY STAR® Partner, we have determined that this product meets the ENERGY STAR® guidelines for energy efficiency.

**\* This data is subject to change without notice.**

*The native resolution of the monitor is 1680 x 1050, By default, your monitor has 100% (max.) 50% contrast, and 6500K color temperature, with full white pattern, without audio/USB.*

[RETURN TO TOP OF THE PAGE](#)

### Product Views

Follow the links to see various views of the monitor and its components.

## Front View Product Description

[RETURN TO TOP OF THE PAGE](#)

### Physical Function

#### Tilt



#### Swivel

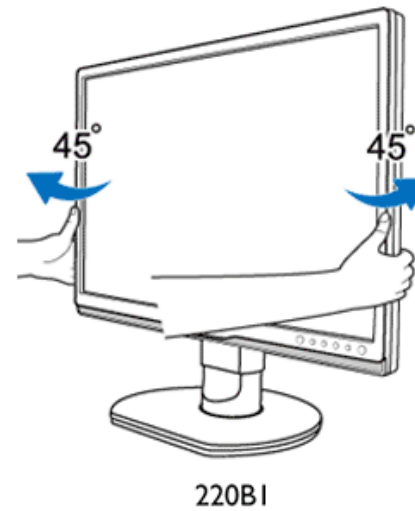
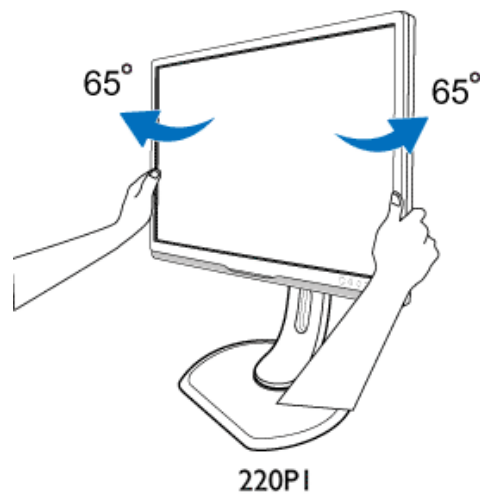



### Height adjustment

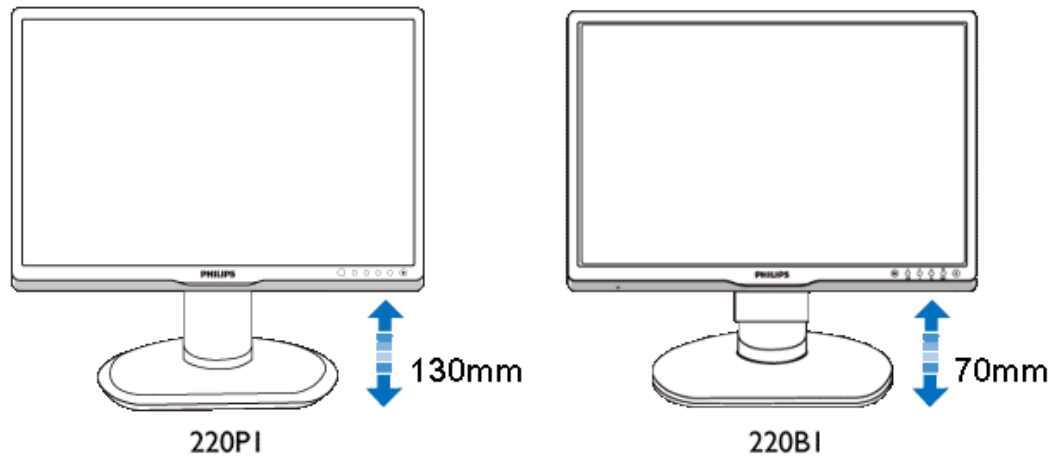

### Pivot (220P1)

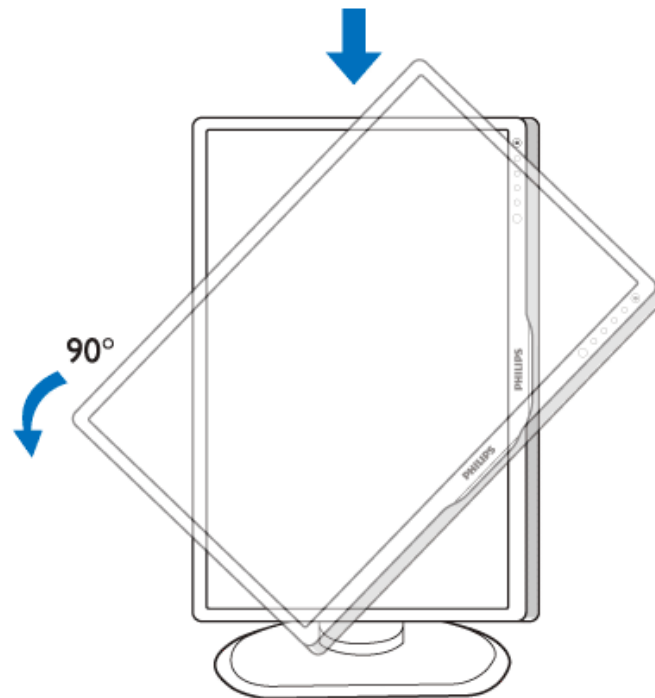

[RETURN TO TOP OF THE PAGE](#)

[Product Features](#)[Technical Specifications](#)[Resolution & Preset Modes](#)[Automatic Power Saving](#)[Physical Specification](#)[Pin Assignment](#)[Product Views](#)

## Philips Pixel Defect Policy

---

### Philips' Flat Panel Monitors Pixel Defect Policy

Philips strives to deliver the highest quality products. We use some of the industry's most advanced manufacturing processes and practice stringent quality control. However, pixel or sub pixel defects on the TFT LCD panels used in flat panel monitors are sometimes unavoidable. No manufacturer can guarantee that all panels will be free from pixel defects, but Philips guarantees that any monitor with an unacceptable number of defects will be repaired or replaced under warranty. This notice explains the different types of pixel defects and defines acceptable defect levels for each type. In order to qualify for repair or replacement under warranty, the number of pixel defects on a TFT LCD panel must exceed these acceptable levels. For example, no more than 0.0004% of the sub pixels on a 19" XGA monitor may be defective. Furthermore, Philips sets even higher quality standards for certain types or combinations of pixel defects that are more noticeable than others. This policy is valid worldwide.

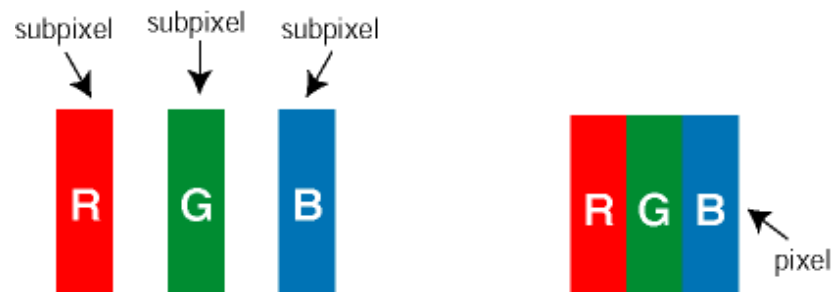

#### Pixels and Sub pixels

A pixel, or picture element, is composed of three sub pixels in the primary colors of red, green and blue. Many pixels together form an image. When all sub pixels of a pixel are lit, the three colored sub pixels together appear as a single white pixel. When all are dark, the three colored sub pixels together appear as a single black pixel. Other combinations of lit and dark sub pixels appear as single pixels of other colors.

#### Types of Pixel Defects

Pixel and sub pixel defects appear on the screen in different ways. There are two categories of pixel defects and several types of sub pixel defects within each category.

**Bright Dot Defects** Bright dot defects appear as pixels or sub pixels that are always lit or 'on'. That is, a *bright dot* is a sub-pixel that stands out on the screen when the monitor displays a dark pattern. There are the types of bright dot defects:

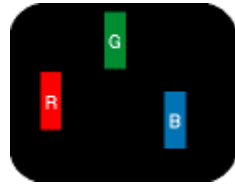

One lit red, green or blue sub pixel

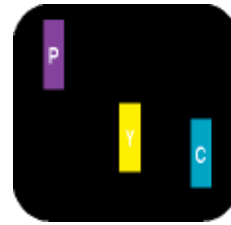

Two adjacent lit sub pixels:

- Red + Blue = Purple
- Red + Green = Yellow
- Green + Blue = Cyan (Light Blue)



Three adjacent lit sub pixels (one white pixel)



A red or blue *bright dot* must be more than 50 percent brighter than neighboring dots while a green bright dot is 30 percent brighter than neighboring dots.

**Black Dot Defects** Black dot defects appear as pixels or sub pixels that are always dark or 'off'. That is, a *dark dot* is a sub-pixel that stands out on the screen when the monitor displays a light pattern. These are the types of black dot defects:

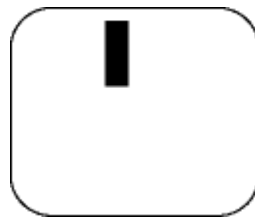

One dark sub pixel

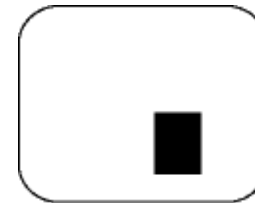

Two or three adjacent dark sub pixels

#### Proximity of Pixel Defects

Because pixel and sub pixels defects of the same type that are near to one another may be more noticeable, Philips also specifies tolerances for the proximity of pixel defects.

## Pixel Defect Tolerances

In order to qualify for repair or replacement due to pixel defects during the warranty period, a TFT LCD panel in a Philips flat panel monitor must have pixel or sub pixel defects exceeding the tolerances listed in the following tables.

<b>BRIGHT DOT DEFECTS</b>	<b>ACCEPTABLE LEVEL</b>
<i>MODEL</i>	<b>220P1/220B1</b>
1 lit subpixel	3
2 adjacent lit subpixels	1
3 adjacent lit subpixels (one white pixel)	0
Distance between two bright dot defects*	>15mm
Total bright dot defects of all types	3

<b>BLACK DOT DEFECTS</b>	<b>ACCEPTABLE LEVEL</b>
<i>MODEL</i>	<b>220P1/220B1</b>
1 dark subpixel	5 or fewer
2 adjacent dark subpixels	2 or fewer
3 adjacent dark subpixels	0
Distance between two black dot defects*	>15mm
Total black dot defects of all types	5 or fewer

<b>TOTAL DOT DEFECTS</b>	<b>ACCEPTABLE LEVEL</b>
<i>MODEL</i>	<b>220P1/220B1</b>
Total bright or black dot defects of all types	5 or fewer

*Note:*

*\* 1 or 2 adjacent sub pixel defects = 1 dot defect*

[RETURN TO TOP OF THE PAGE](#)

[Product Information](#)[Philips Pixel Defect Policy](#)[Philips SmartControl II](#)[System support and requirement](#)  
[Installation](#)[Start to use](#)[Q&A](#)

## SmartControl II (Selective Models)

### Philips SmartControl II

SmartControl II is monitor-based software with an easy-to-use on-screen graphic interface that guides you through fine-tuning resolution, color calibration and other display settings including brightness, contrast, clock & phase, position, RGB, white point and - on models with onboard speakers - volume adjustments.

### **System support and requirement:**

1. Sytem support: 2000, XP, NT 4.0, XP 64 Edition, Vista 32/64. IE Support 6.0/7.0.
2. Language support: English, Simplified Chinese, German, Spanish, French, Italian, Russian, Portuguese.
3. Philips Monitor support DDC/CI Interface.

### **Installation:**

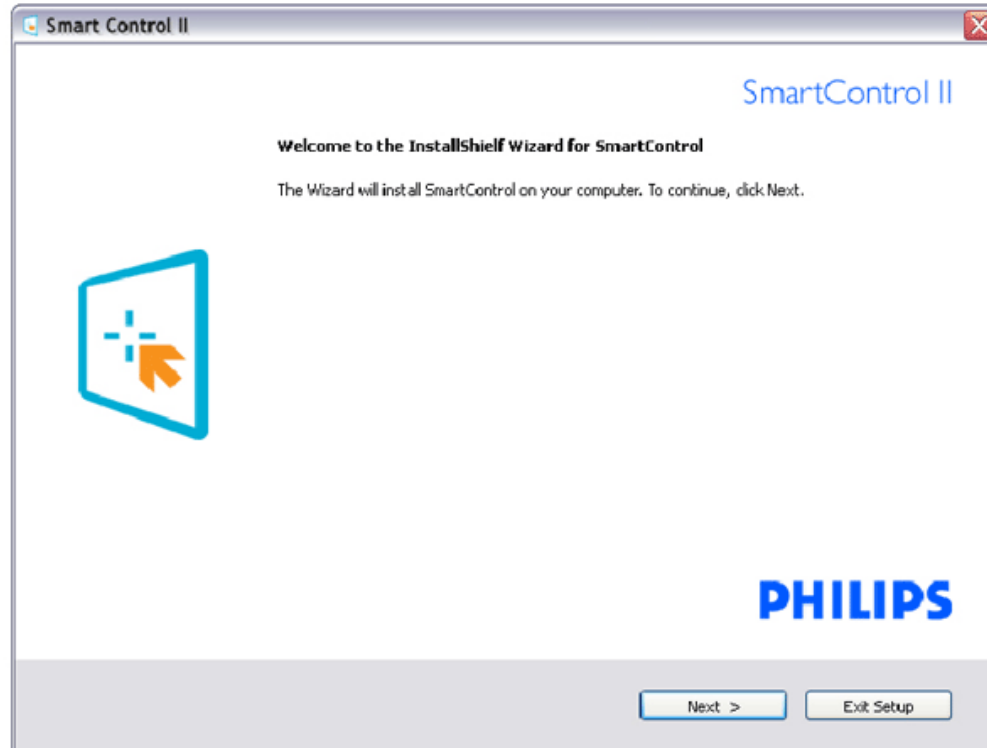

- Follow the instruction and complete the installation.
- You can launch after installation complete.
- If you want to launch later, you can either click the shortcut on desktop or toolbar.

### Start to use:

#### 1. First launch -Wizard

- The first time after installation of SmartControl II, it will automatically go to Wizard for first time launch.
- The wizard will guide you through adjustment your monitor performance step by step.
- You can go to Plug-in menu to launch wizard later on as well.
- You can adjust more options without wizard by Standard pane.

Wizard Analog Sequence	Wizard Digital Sequence
Resolution	Resolution
Focus	Contrast
Brightness	Brightness
Contrast	White Point (Color Temp)
Position	File
White Point (Color Temp)	
File	

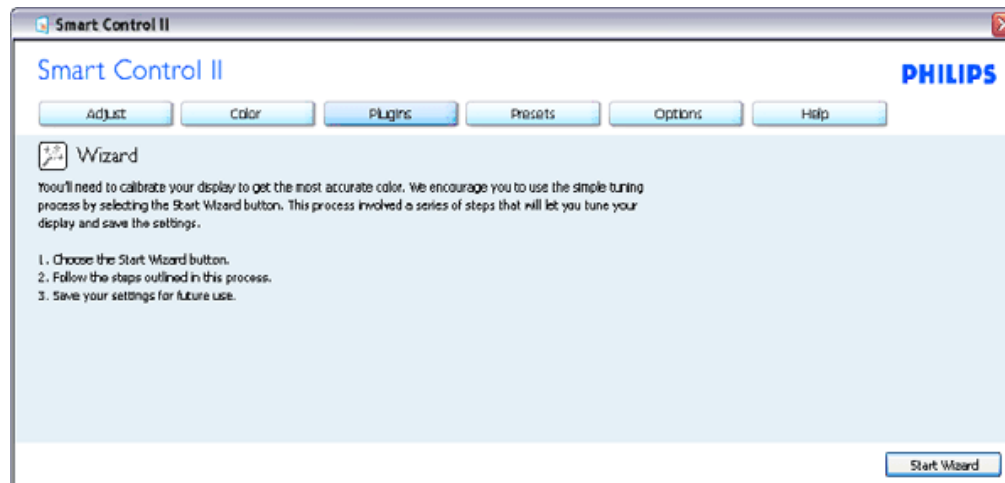

#### 2. Start with Standard pane:

#### Adjust menu:

- Adjust Menu allow you to adjust Brightness, Contrast, Focus, Position and Resolution.
- You can follow the instruction and do the adjustment.
- Cancel prompts user if you want to cancel installation.

Tab Heading	Sub Menu	Display in Analog	Display in Digital
Adjust	Brightness	Yes	Yes
Adjust	Contrast	Yes	Yes
Adjust	Focus (Clock & Clock Phase)	Yes	No
Adjust	Position	Yes	No
Adjust	Resolution	Yes	Yes

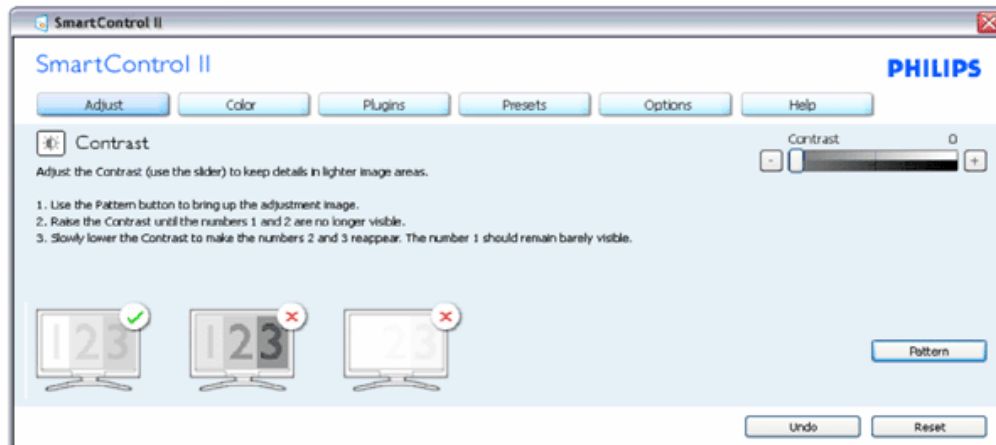
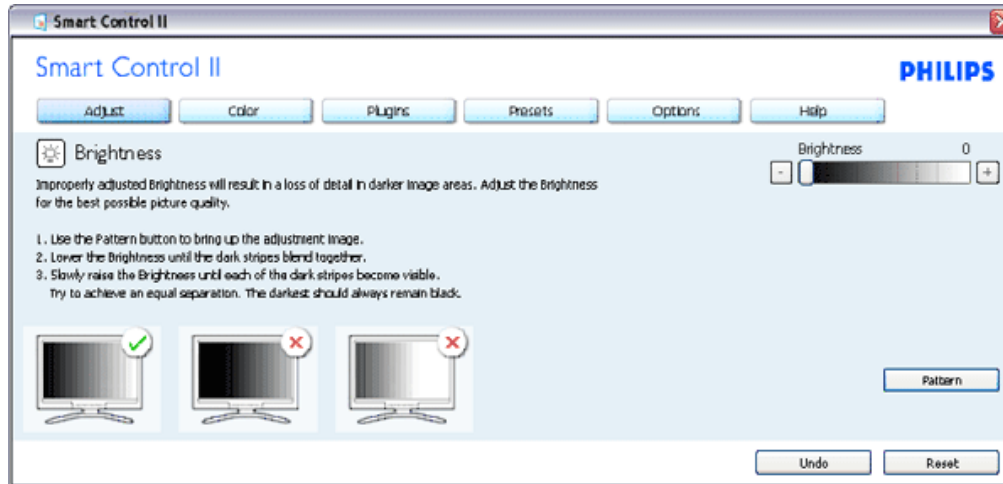



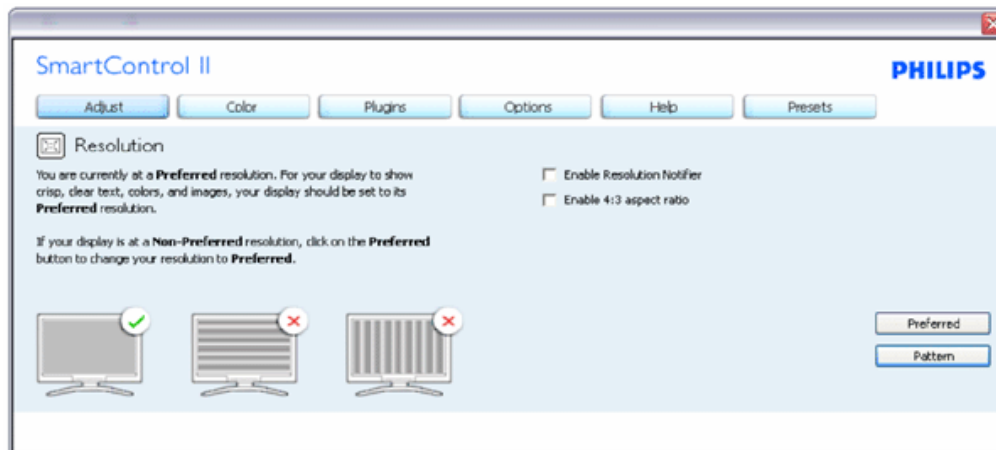
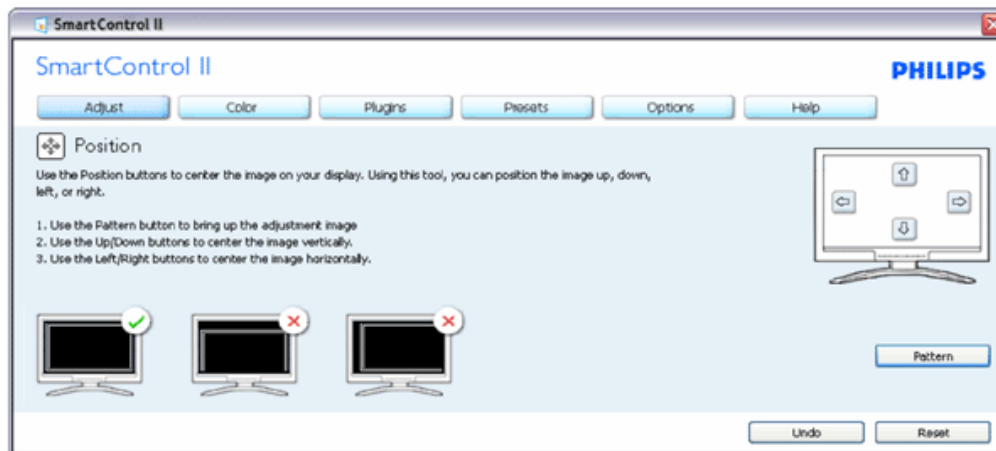
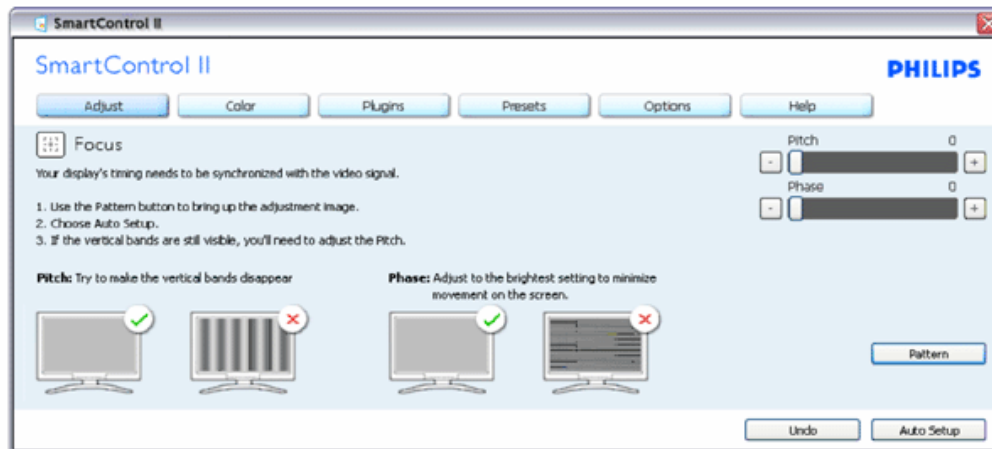

### Color menu:

- Color Menu allow you to adjust RGB, Black Level, White Point, Color Calibration, and SmartImage (Please refer to SmartImage section).
- You can follow the instruction and do the adjustment.
- Refer to below table for sub-menu item base on your input.
- Example for Color Calibration

Tab Heading	Sub Menu	Display in Analog	Display in Digital
Color	RGB	Yes	Yes
Color	Black Level	Yes	Yes
Color	White Point	Yes	Yes
Color	Color Calibration	Yes	Yes
Color	Viewing Mode	Yes	Yes

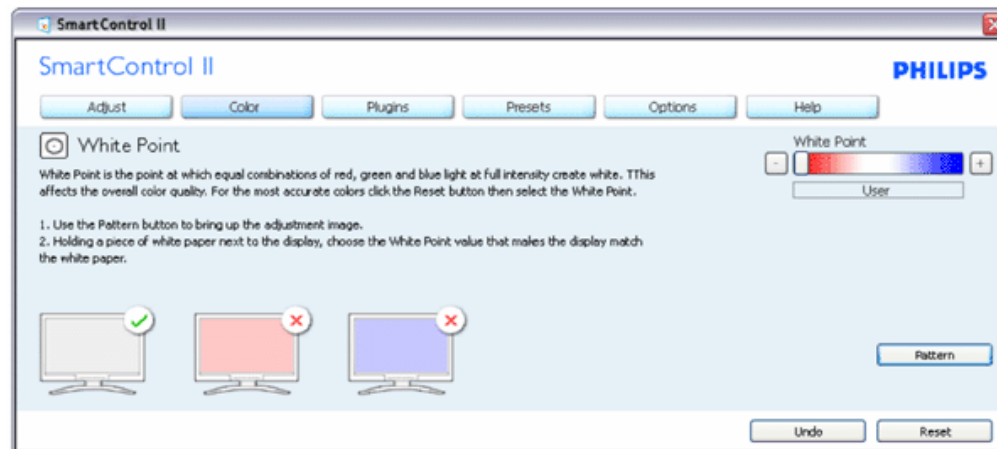
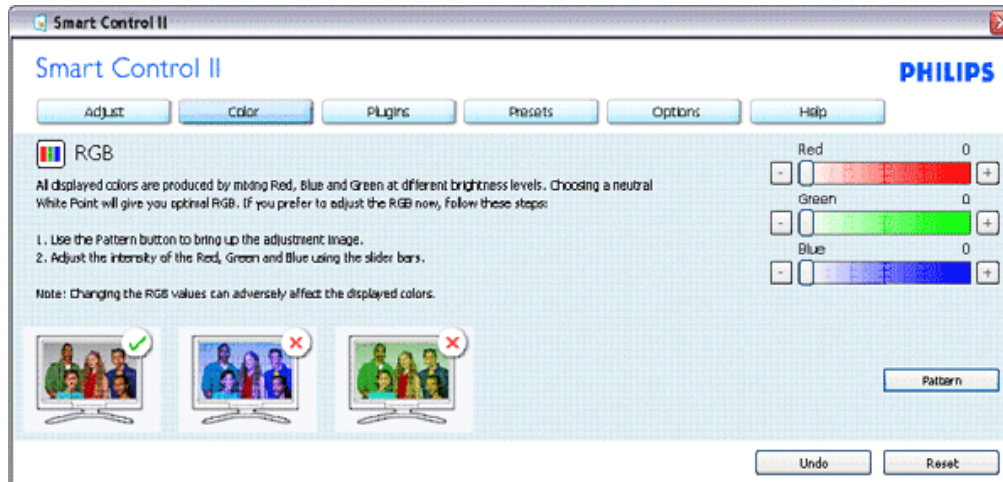

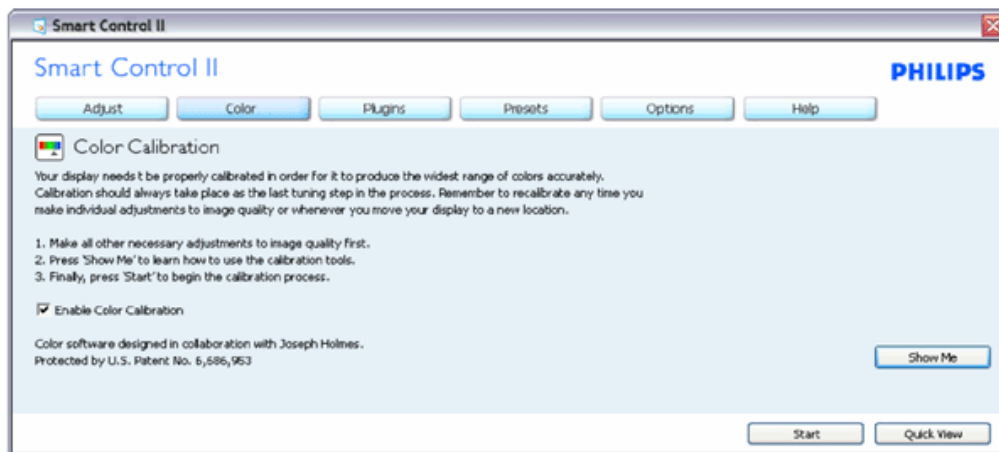
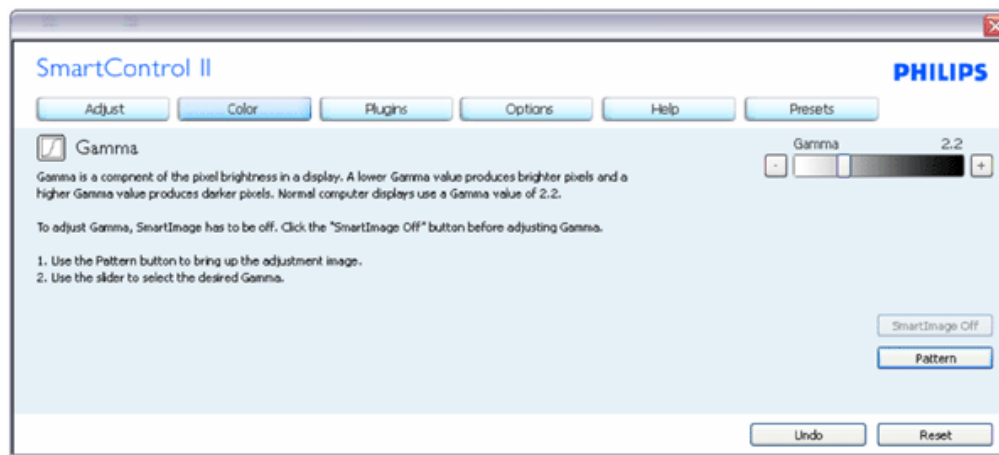

1. "Show Me" starts color calibration tutorial.
2. Start - starts the 6-step color calibration sequence.
3. Quick View loads the before/after images.
4. To return to Color home pane, click the Cancel button.
5. Enable color calibration - by default is on. If unchecked, does not allow for color calibration to happen, dimes out start and quick view buttons.
6. Must have patent info in calibration screen.

#### First color Calibration Screen:

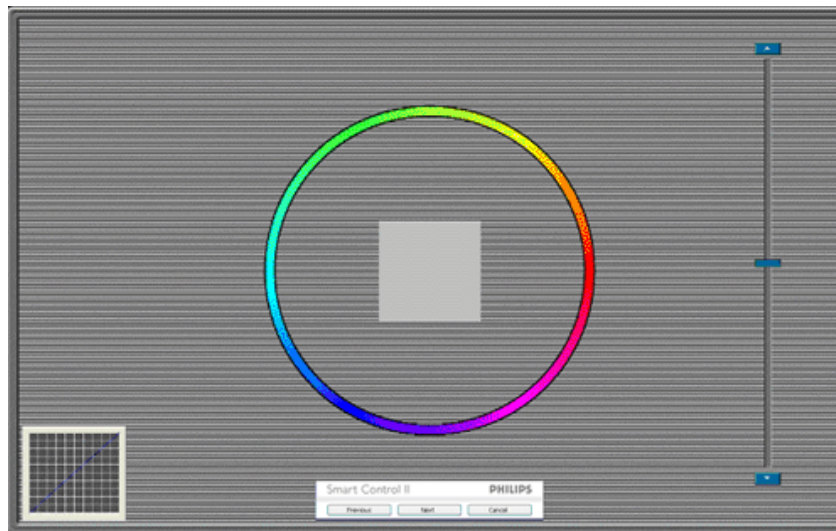

1. Previous button is disabled until the second color screen.
2. Next goes to the succeeding target (6-targets).
3. Final next goes File>Presets pane.
4. Cancel closes the UI and returns to the plug in page.

**SmartImage** - Allows user to change setting for better display setting based on content.

When Entertainment is set, SmartContrast and SmartResponse are enabled.

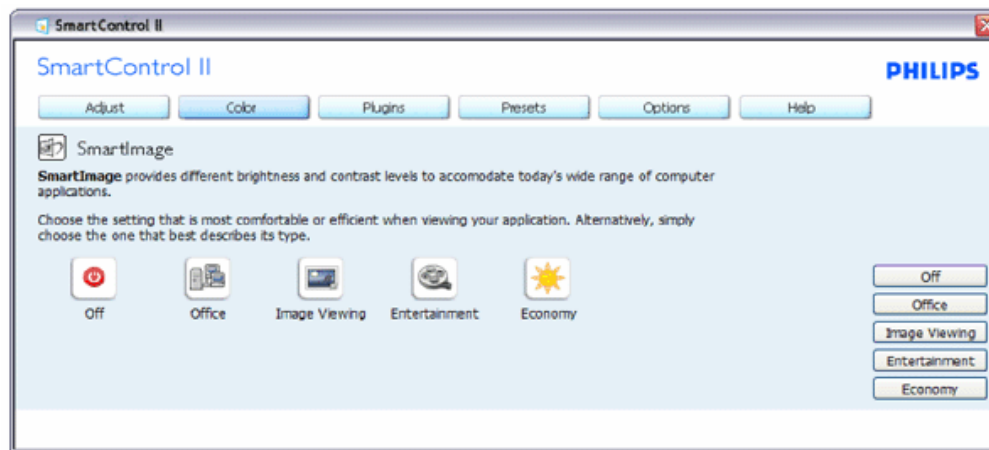

**Plug-Ins - Asset Management Pane will only be active when selecting Asset Management from the drop-down Plug Ins menu.**

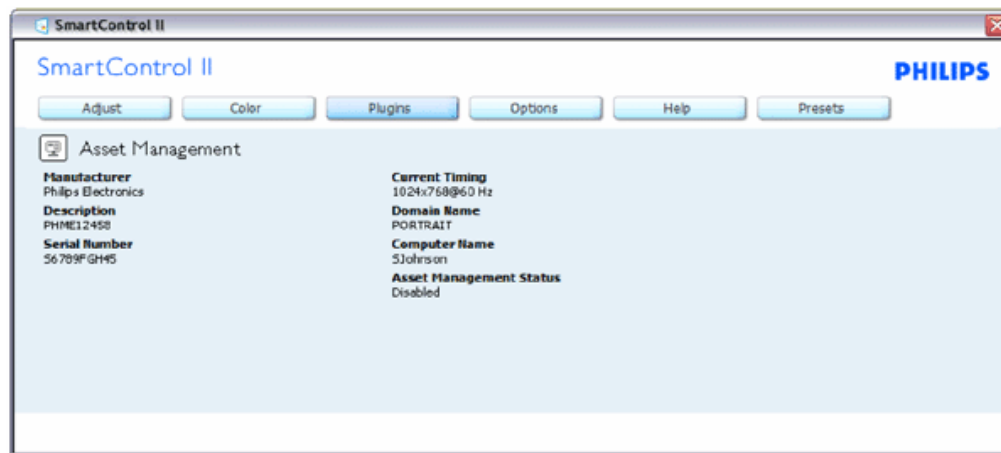

Displays Assent Management information on Management, Description, Serial Number, Current Timing, Domain Name, and Asset Management Status.

To return to Plug-in home pane select the plug-in tab.

**Plug-Ins - Theft Deterrence Pane will only be active when selecting Theft Deterrence Mode from the drop-down Plug Ins menu.**

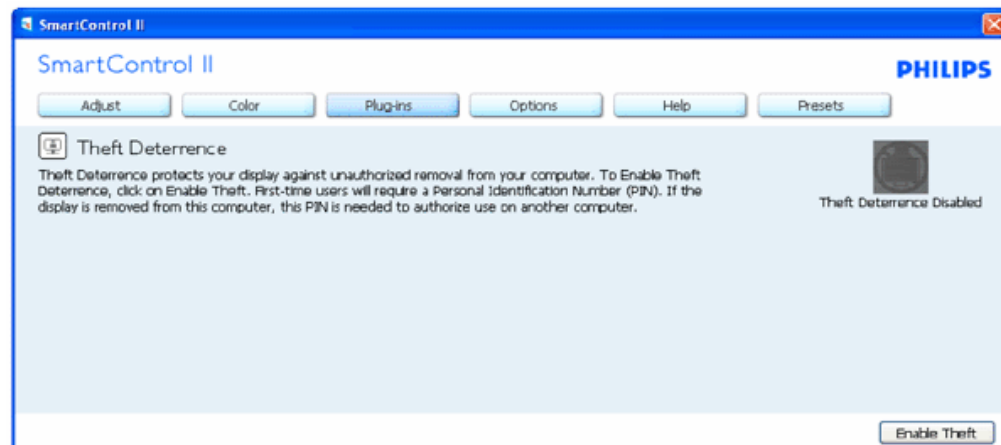

To enable Theft Deterrence, clicking Enable Theft Mode button brings up the following screen:



1. User can enter PIN between 4 and 9 digits numbers only.
2. After entering PIN, Accept button takes user to the pop-up dialog box on the following page.
3. Minimum minutes set to 5. Slider set to 5 by default.
4. Does not require the display be attached to a different host to go into theft mode.

Once a PIN is entered and accepted, the following dialog box appears:

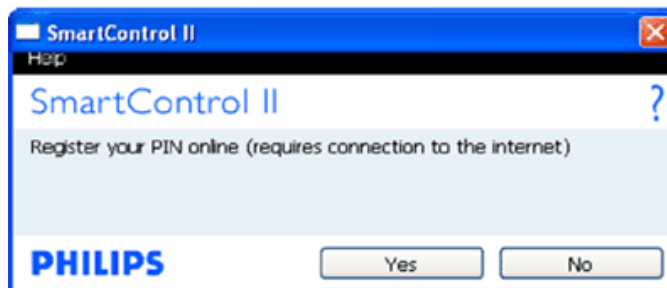

- Click on No button takes user to the following screen.



- Click on Yes button takes user to secure web site landing page.

After creating PIN, the Theft Deterrence pane will indicate Theft Deterrence Enabled and provide PIN Options button:



1. Theft Deterrence Enabled is displayed.
2. Disable Theft Mode opens pane screen on next page.
3. PIN Options button only available after user creates PIN, button opens secure PIN web site.

Disable Theft button opens the following pane:



1. After entering PIN, Accept button disables PIN.
2. Cancel button opens up main Theft Deterrence pane, displaying Theft Deterrence Disabled. Enable Theft Mode and PIN Options buttons.
3. Entering incorrect PIN results in the following dialog box:

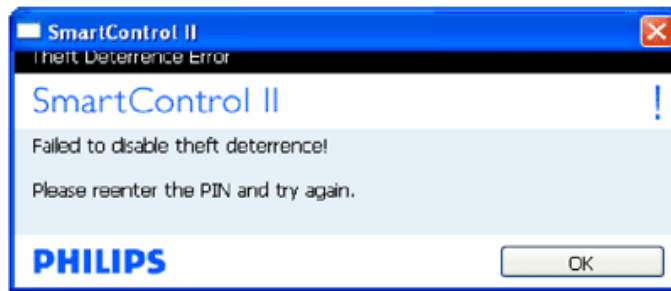

**Options>Preferences** - Will only be active when selecting Preferences from the drop-down Options menu. On a non-supported display capable of DDC/CI, only the Help and Options tabs are available.

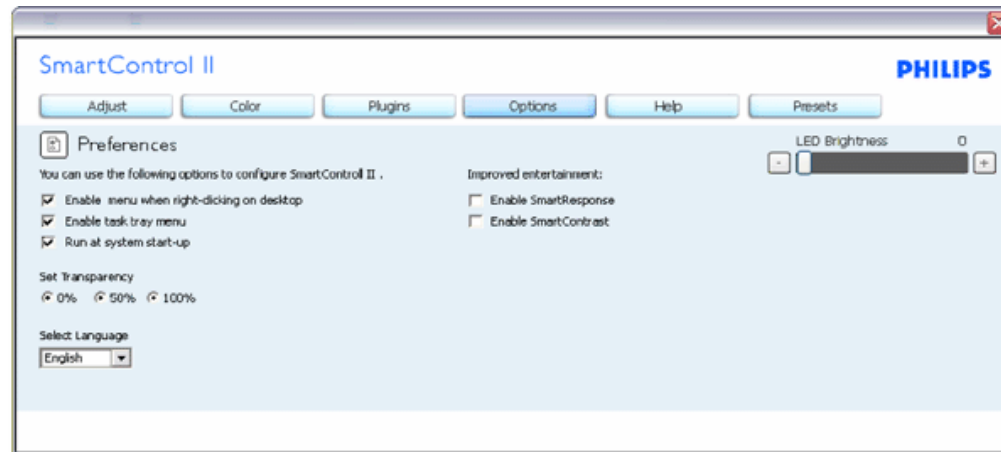

1. Displays current preference settings.
2. A checked box enables the feature. The check box is a toggle.
3. Enable Context Menu on desktop is checked (On) by default. Enable Context menu displays SmartControl II selections for Select Preset and Tune Display in the desktop right-click context menu. Disabled removes SmartControl II from the right click context menu.
4. Enable Task Tray icon is checked (On) by default. Enable context menu shows the task tray menu for SmartControl II. A right click on the task tray icon displays the menu options for Help, Technical Support. Check for Upgrade, About, and Exit. When Enable task tray menu is disabled, the task tray icon will only display EXIT.
5. Run at Startup is checked (On) by default. When disabled, SmartControl II will not launch at start or be in the task tray. The only way to launch SmartControl II is either from the desktop short cut or from the program file. Any preset set to run at startup will not load when this box is unchecked (Disabled).
6. Enable transparency mode (Vista, XP, and 2k only). Default is 0% Opaque.

**Options>Input** - Will only be active when selecting Input from the drop-down Options menu. On a non-supported display capable of DDC/CI, only the Help and Options tabs are available. All other SmartControl II tabs are not available.



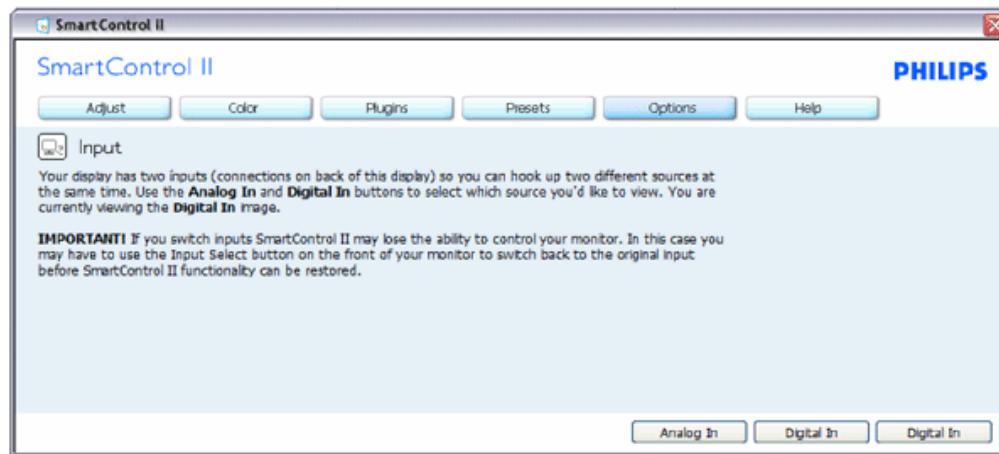

1. Display the Source instruction pane and current input source setting.
2. On single input displays, this pane will not be visible.

**Options>Audio - Will only be active when selecting Volume from the drop-down Options menu. On a non-supported display capable of DDC/CI, only the Help and Options tabs are available.**

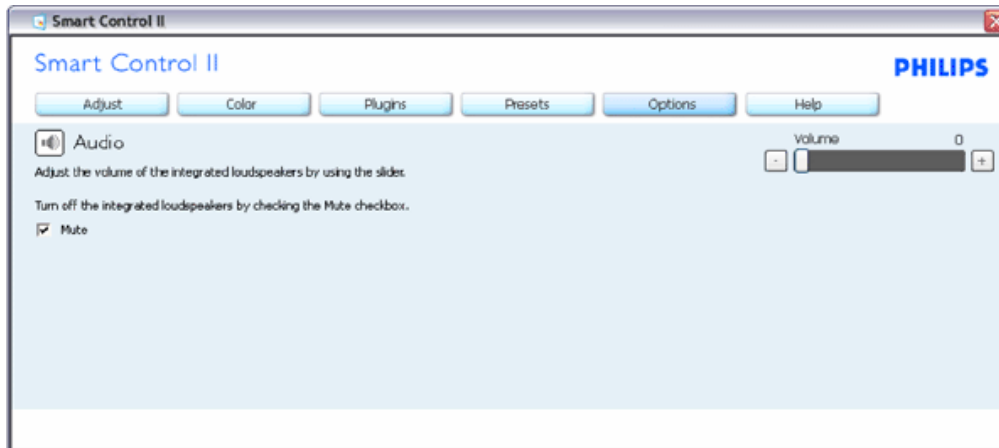

**Option>Auto Pivot**

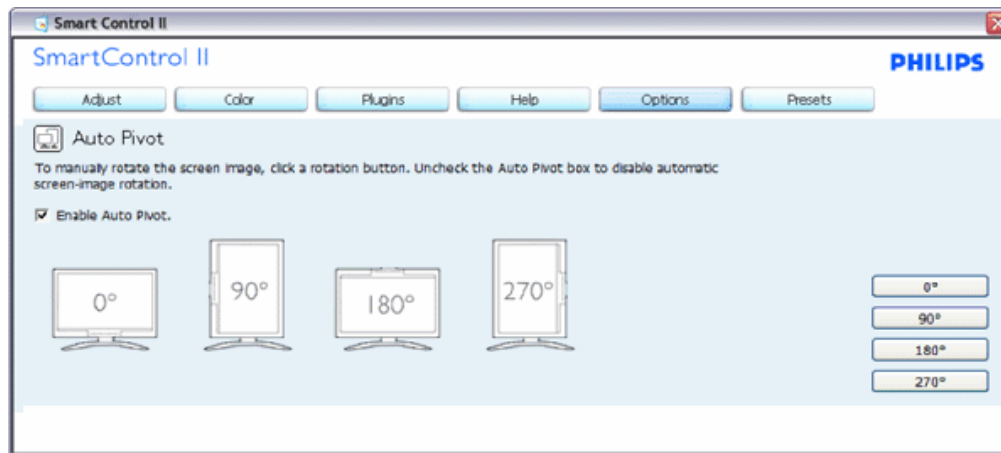

**Help>User Manual - Will only be active when selecting User Manual from the drop-down Help menu. On a non-supported display capable of DDC/CI, only the Help and Options tabs are available.**

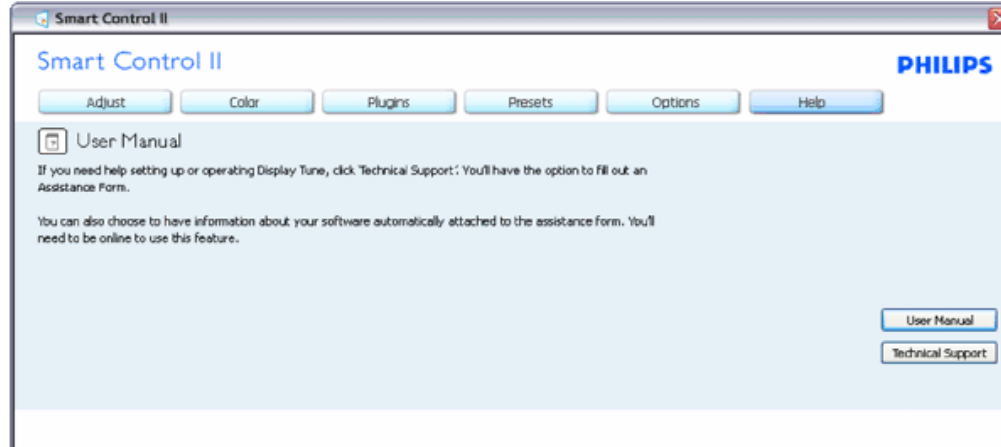

**Help>Version - Will only be active when selecting Version from the drop-down Help menu. On a non-supported display capable of DDC/CI, only the Help and Options tabs are available.**

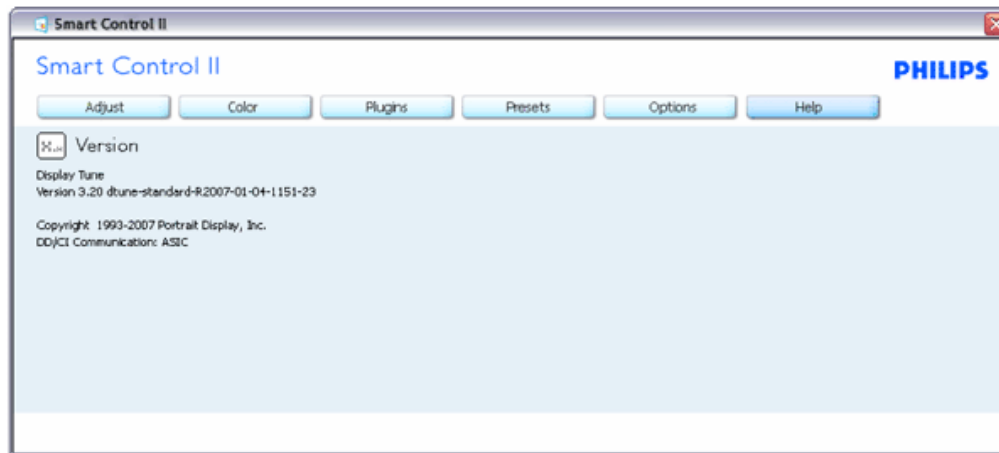

### Context Sensitive menu

The Context Sensitive menu is Enabled by default. If Enable Context Menu has been checked in the Options>Preferences pane, then the menu will be visible.

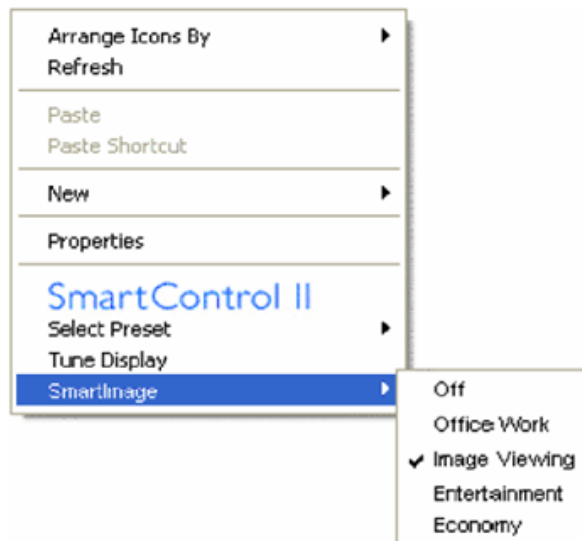

The Context Menu has four entries:

1. SmartControl II - When selected the About Screen is displayed.
2. Select Preset - Provides a hierarchical menu of saved presets for immediate use. A check mark shows the currently selected preset. Factory Preset can also be called from the drop down menu.
3. Tune Display - Opens the SmartControl II control panel.
4. Fly off for SmartImage - Check current settings, Off, Office Work, ImageViewing, Entertainment, Economy.

### Task Tray Menu Enabled

The task tray menu can be displayed by right-clicking on the SmartControl II icon from the task tray. Left Click will launch the application.



The task tray has five entries:

1. Help - Access to User Manual file: opens User Manual file using the default browser window.
2. Technical Support - displays the tech support page.
3. Check for Update - takes the user to PDI Landing and checks the user's version against the most current available.
4. About - Displays detailed reference information: product version, release information, and product name.
5. Exit - Close SmartControl II. To run SmartControl II again either select SmartControl II from Program menu, double-click the desktop PC icon or restart the system.



#### Task Tray Menu Disabled

When the Task Tray is disabled in the preference folder, only the EXIT selection is available. To completely remove SmartControl II from the task tray, disable Run at Startup in Options>Preferences.

---

#### Q&A

**Q1.** I change the monitor on a PC to a different one and the SmartControl becomes un-usable, what do I do?

**A.** Restart your PC and see if SmartControl can work. Otherwise, you will need to remove and re-install SmartControl to ensure proper driver is installed.

**Q2.** The SmartControl functions well at the beginning, but it is not workable, what can I do?

**A.** If the following actions were executed, the monitor driver may need to be re-installed.

- Change video graphic adapter to another one
- Update video driver
- Activities on OS, such as service pack or patch
- Run Windows Update and updated monitor and/or video driver
- Windows was booted with the monitor power off or disconnected.

To find out, please right click My Computer and click on Properties->Hardware-> Device Manager.

If you see "Plug and Play Monitor" shows under Monitor, then you need to re-install. Simply remove SmartControl and re-install it.

**Q3.** After installing SmartControl, when clicking on SmartControl tab, nothing shows up after a while or a failure message shows, what happened?

**A.** It might be your graphic adaptor is not compatible with the SmartControl. If your graphic adaptor is one of the above mentioned brands, try to download the most updated graphic adaptor driver from corresponding companies web site. Install the driver. Remove SmartControl, and re-install it once more.

If it is still not working, we are sorry that the graphic adaptor is not supported. Please pay attention to Philips web site for any updated SmartControl driver available.

**Q4.** When I click on Product Information, only partial information is shown, what happened?

**A.** It might be your graphic card adaptor driver is not the most updated version which fully supporting DDC/CI interface. Please try to download the most updated graphic adaptor driver from corresponding companies web site. Install the driver. Remove SmartControl, and re-install it once more.

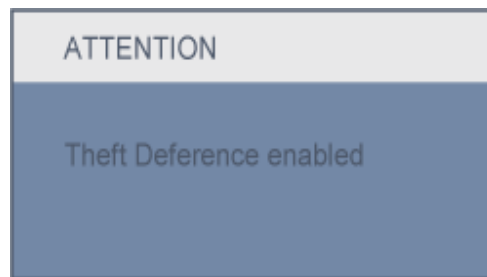

**Q5.** I forgot my PIN for Theft Deterrence Function. How can I do?

**A.** Please contact IT manager or Philips Service Center.

**Q6.** In a monitor with the SmartImage feature, the sRGB scheme of color temperature function in SmartControl is not responding, why?

**A.** When SmartImage is enabled, the sRGB scheme is disabled automatically. To use sRGB, you need to disable SmartImage with the  button at the front bezel of your monitor.





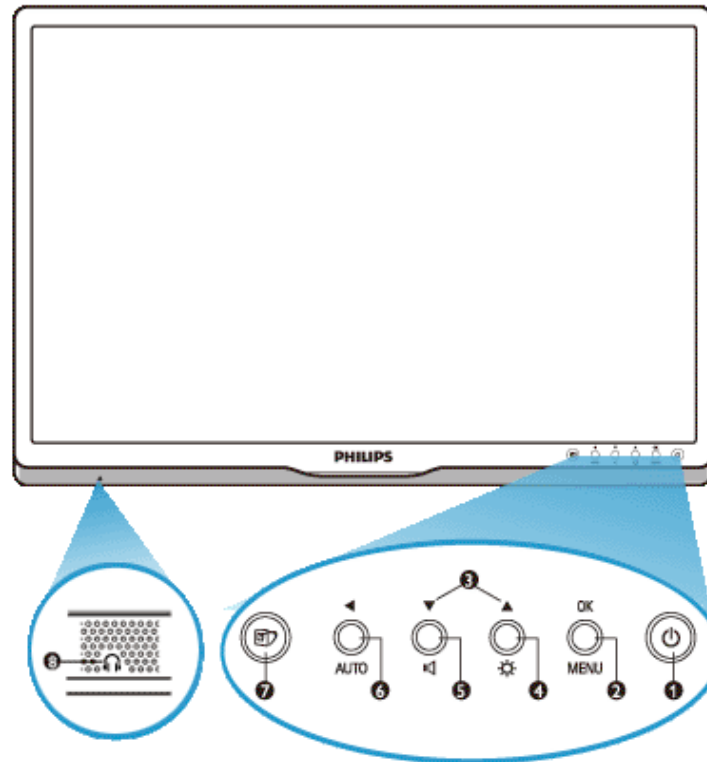

[RETURN TO TOP OF THE PAGE](#)

- Front View Product Description
- Connecting to Your PC
- The Base
- Getting Started
- Optimizing Performance

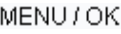
## Installing Your LCD Monitor

### Front View Product Description

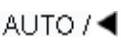

-  To switch monitor's power On and Off
-  To access the OSD menu
-  To adjust the OSD menu
-  To adjust brightness of the display
-  To adjust volume of the display
-  Automatically adjust the horizontal position, vertical position, phase and clock settings / Return to previous OSD level
-  SmartImage. There are five modes to be selected: Office Work, Image Viewing, Entertainment, Economy, and Off



8

Earphone jack

[RETURN TO TOP OF THE PAGE](#)

### Rear View

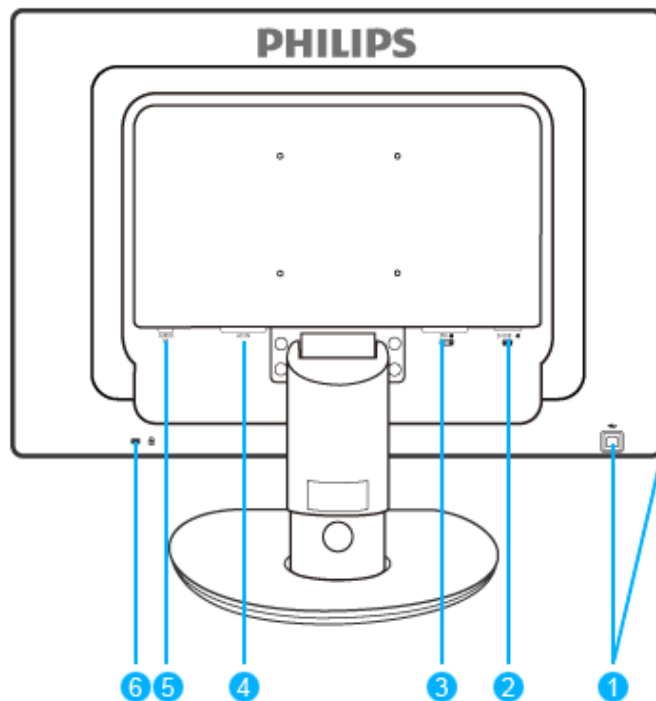

- 1 USB upstream port and downstream port
- 2 VGA input
- 3 DVI-D input (available for selective models)
- 4 AC power input
- 5 PC Audio input
- 6 Kensington anti-thief lock

[RETURN TO TOP OF THE PAGE](#)



## Optimizing Performance

- For best performance, ensure that your display settings are set at 1680x1050, 60Hz.



**Note:** You can check the current display settings by pressing the 'OK' button once. The current display mode is shown in OSD main controls called **RESOLUTION**.

[RETURN TO TOP OF THE PAGE](#)

Front View Product  
Description  
Accessory Pack

Connecting to Your PC  
Getting Started

Optimizing Performance  
The Base

## Connecting to Your PC

---

### Accessory Pack

Unpack all the parts.



Power cord



DVI cable (Optional)



VGA cable (Optional)



EDFU pack



Audio cable

[RETURN TO TOP OF THE PAGE](#)

---

Connecting to Your PC

- 1) Connect the power cord to the back of the monitor firmly. (Philips has pre-connected VGA cable for the first installation.)

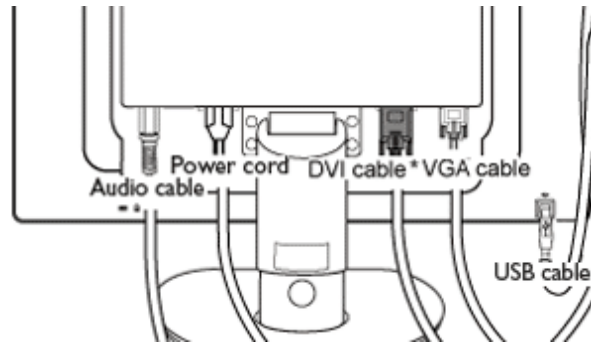

*\*available for selective models*

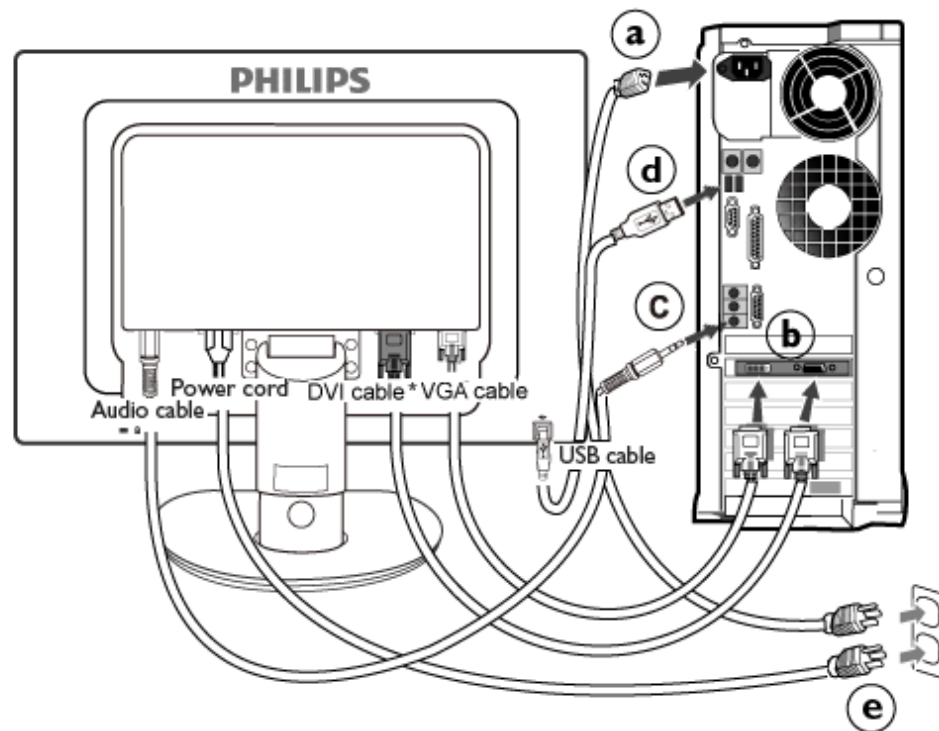

*\*available for selective models*

## 2) Connect to PC

- (a) Turn off your computer and unplug its power cable.
- (b) Connect the monitor signal cable to the video connector on the back of your computer.
- (c) Connect the PC audio cable to the audio connector on the back of your computer.
- (d) Connect the USB upstream port on the monitor and the USB port on PC with a USB cable. The USB downstream port is now ready for any USB device to plug in.
- (e) Plug the power cord of your computer and your monitor into a nearby outlet.
- (f) Turn on your computer and monitor. If the monitor displays an image, installation is complete.

[RETURN TO TOP OF THE PAGE](#)

- Install base stand
- Remove base stand
- Front View Product Description
- Accessory Pack
  
- Connecting to your PC
- Getting Started
  
- Optimizing Performance
- Remove the Base

## The Base

---

### Install base stand

#### 220B1

(a) Place the monitor base stand on a stable surface.

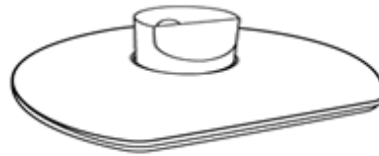

(b) Firmly grasp the monitor with both hands.

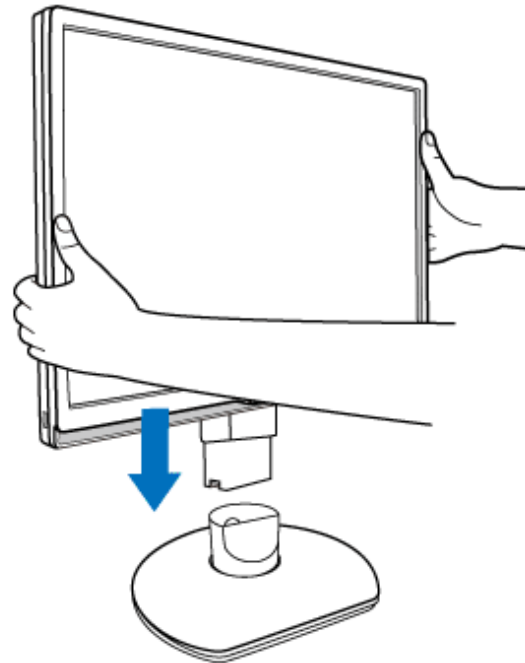

**(c)** Attach the monitor stand to the monitor column until the tabs "click" into place before releasing the height adjustable column.



### **Remove base stand**

#### **220B1**

Before you start disassembling the monitor base, please follow the instructions below to avoid damage or injury.

**a)** Extend the monitor stand to its maximum height.

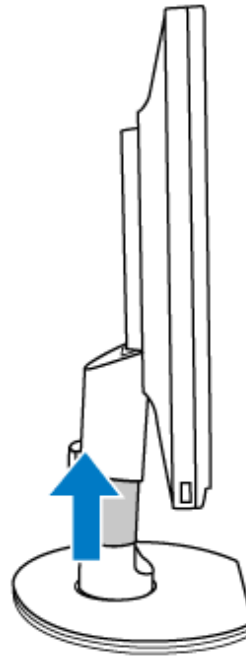

**(b)** Place the monitor face down on a smooth surface, taking care to avoid scratching or damaging the screen. Then lift the monitor stand.

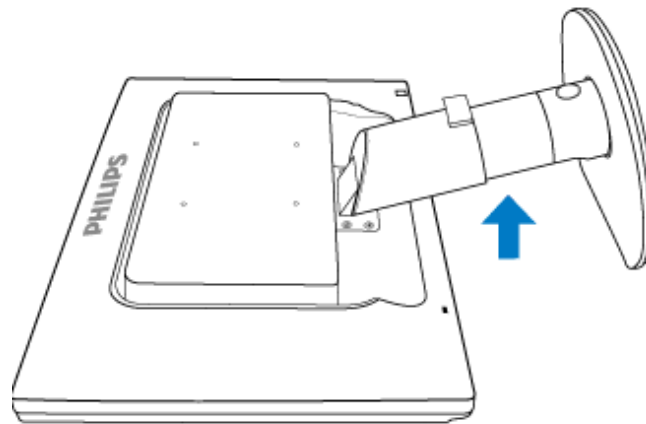

**(c)** Press the release button on the rear of the stand to remove the base from the stand.

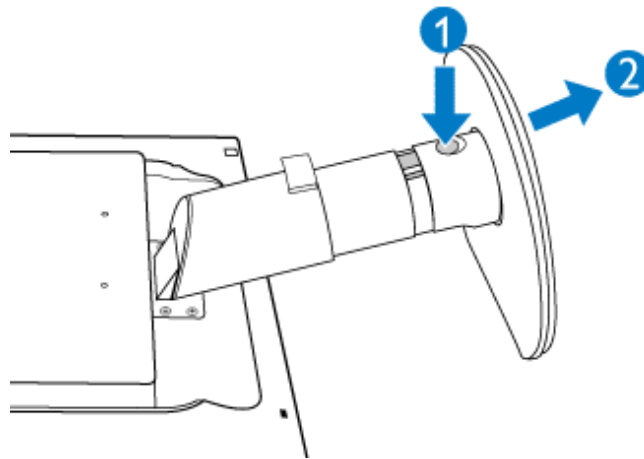

### Remove the Base

#### Condition:

- for VESA standard mounting applications

(a) Remove the 4 screw covers.

**220P1**

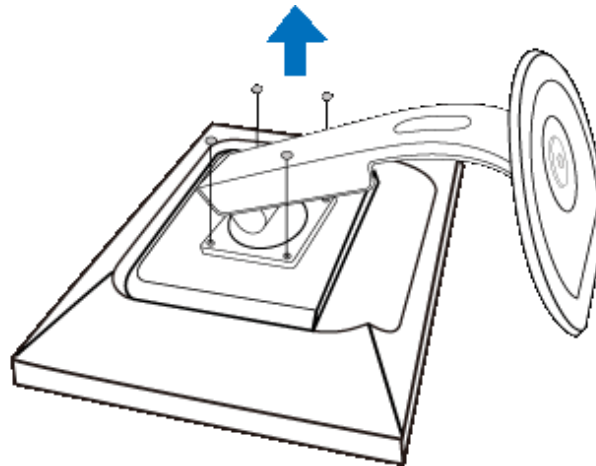

**220B1**



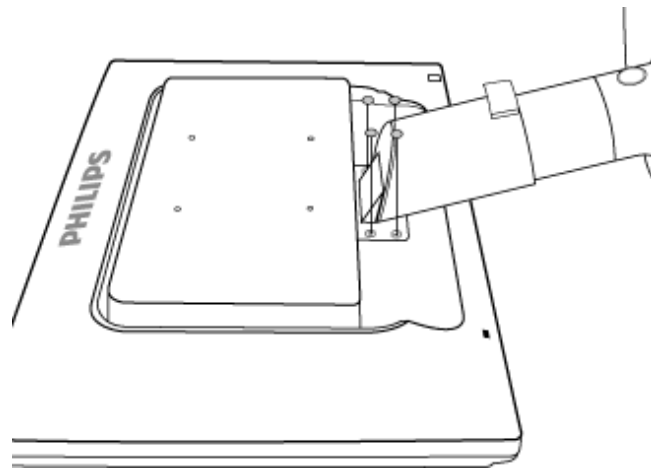

**(b)** Remove the 4 screws and then remove the base from the LCD monitor.

**220P1**

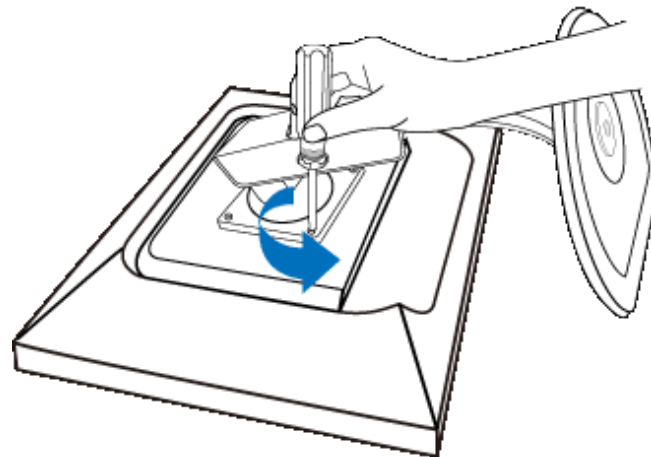

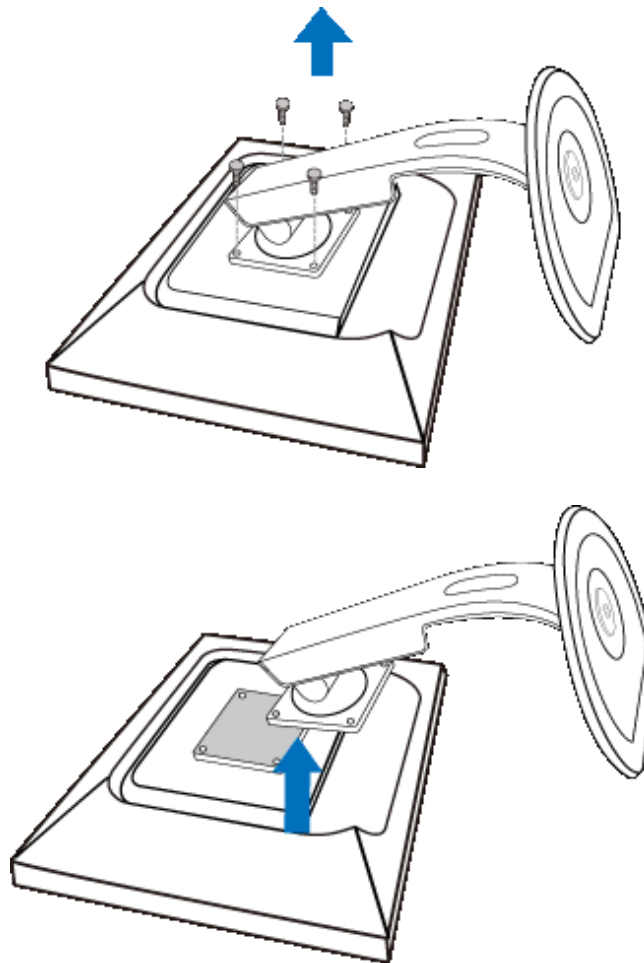

**220B1**

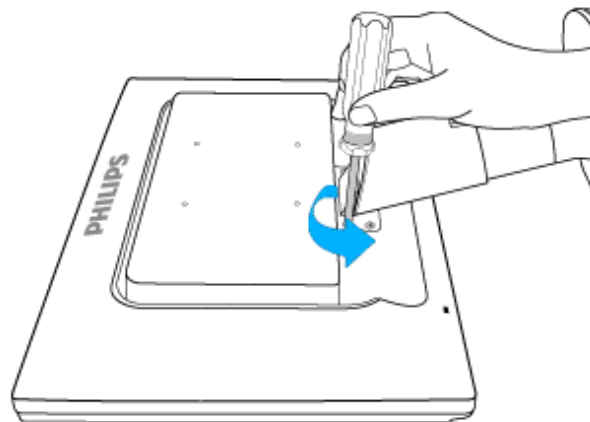

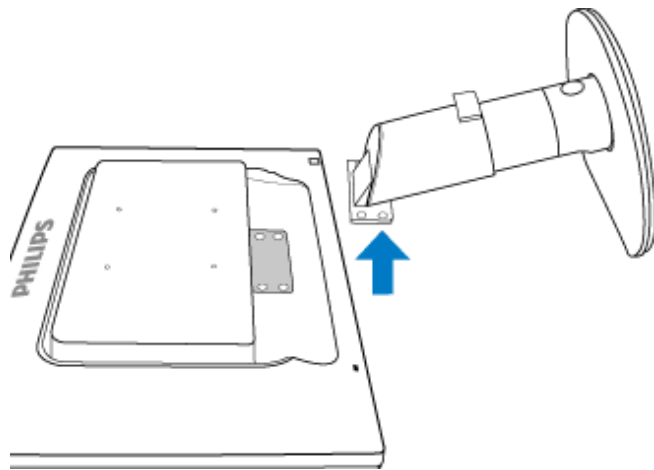
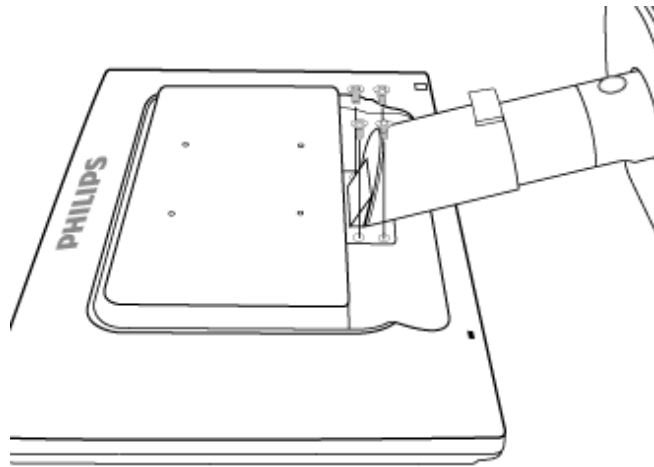

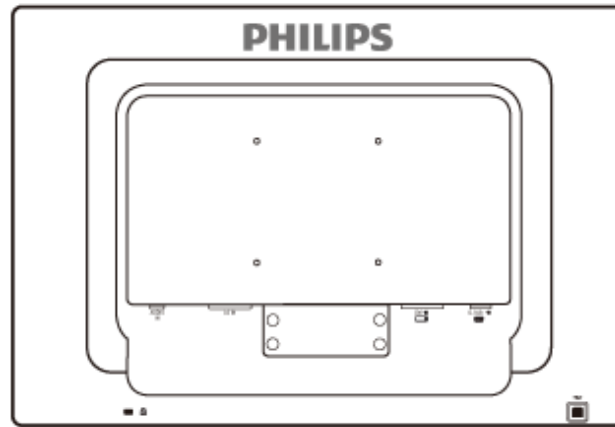

**Note:** This monitor accepts a 100mmx100mm VESA-Compliant mounting interface.

[RETURN TO TOP OF THE PAGE](#)

## Your LCD Monitor :

Front View Product  
Description  
Setting Up and Connecting  
Your Monitor  
Getting Started

Optimizing Performance

## Getting Started

---

### Getting Started

#### Use the information file ( .inf) for Windows® 2000/XP/Vista or later

The built-in VESA DDC2B feature in Philips Monitors supports Plug & Play requirements for Windows® 2000/XP/Vista. This information file ( .inf) should be installed in order that your Philips monitor can be enabled from the 'Monitor' dialog box in Windows® 2000/XP/Vista and the Plug & Play application can be activated. The installation procedure based on Windows® 2000 , XP and Vista is specified as follows.

#### For Windows® 2000

1. Start Windows® 2000
2. Click on the 'Start' button, point to 'Settings', and then click on 'Control Panel'.
3. Double click on the 'Display' Icon.
4. Select the 'Settings' tab then click on 'Advanced...'
5. Select 'Monitor'
  - If the 'Properties' button is inactive, it means your monitor is properly configured. Please stop installation.
  - If the 'Properties' button is active. Click on 'Properties' button. Please follow the steps given below.
6. Click on 'Driver' and then click on 'Update Driver...' then click on the 'Next' button.
7. Select 'Display a list of the known drivers for this device so that I can choose a specific driver', then click on 'Next' and then click on 'Have disk...'
8. Click on the 'Browse...' button then select the appropriate drive F: ( CD-ROM Drive).
9. Click on the 'Open' button, then click on the 'OK' button.
10. Select your monitor model and click on the 'Next' button.
11. Click on the 'Finish' button then the 'Close' button.
  - If you can see the 'Digital Signature Not Found' window, click on the 'Yes' button.

#### For Windows® XP

1. Start Windows® XP
2. Click on the 'Start' button and then click on 'Control Panel'.
3. Select and click on the category 'Printers and Other Hardware'
4. Click on the 'Display' Item.
5. Select the 'Settings' tab then click on the 'Advanced' button.
6. Select 'Monitor' tab
  - If the 'Properties' button is inactive, it means your monitor is properly configured. Please stop installation.

- If the 'Properties' button is active, click on 'Properties' button.  
Please follow the steps below.
- 7. Click on the 'Driver' tab and then click on 'Update Driver...' button.
- 8. Select the 'Install from a list or specific location [advanced]' radio button and then click on the 'Next' button.
- 9. Select the 'Don't Search. I will choose the driver to install' radio button. Then click on the 'Next' button.
- 10. Click on the 'Have disk...' button, then click on the 'Browse...' button and then select the appropriate drive F: (CD-ROM Drive).
- 11. Click on the 'Open' button, then click the 'OK' button.
- 12. Select your monitor model and click on the 'Next' button.
  - If you can see the 'has not passed Windows® Logo testing to verify its compatibility with Windows® XP' message, please click on the 'Continue Anyway' button.
- 13. Click on the 'Finish' button then the 'Close' button.
- 14. Click on the 'OK' button and then the 'OK' button again to close the Display\_Properties dialog box.

### For Windows® Vista

1. Start Windows® Vista
2. Click the Start button; select and click on 'Control Panel'.
3. Select and click on 'Hardware and Sound'
4. Choose 'Device Manager' and Click on 'Update device drivers'.
5. Select 'Monitor' and then right click on 'Generic PnP Monitor'.
6. Click on 'Update Driver Software'.
7. Select 'Browse my computer for driver software'.
8. Click the 'Browse' button and choose the drive in which you've placed the disk. Example: (CD-ROM Drive:\\Lcd\\PC\\drivers\\).
9. Click the 'Next' button.
10. Wait few minutes for installing the driver, and then click 'Close' button.

If your Windows® 2000/XP/Vista version is different or you need more detailed installation information, please refer to your Windows® 2000/XP/Vista user's manual.

[RETURN TO TOP OF THE PAGE](#)

Description of the On-Screen Display  
The OSD Tree

## On-Screen Display

### Description of the On Screen Display

#### *What is the On-Screen Display?*

On-Screen Display (OSD) is a feature in all Philips LCD monitors. It allows an end user to adjust screen performance or select functions of the monitors directly through an on-screen instruction window. A user friendly on screen display interface is shown as below :

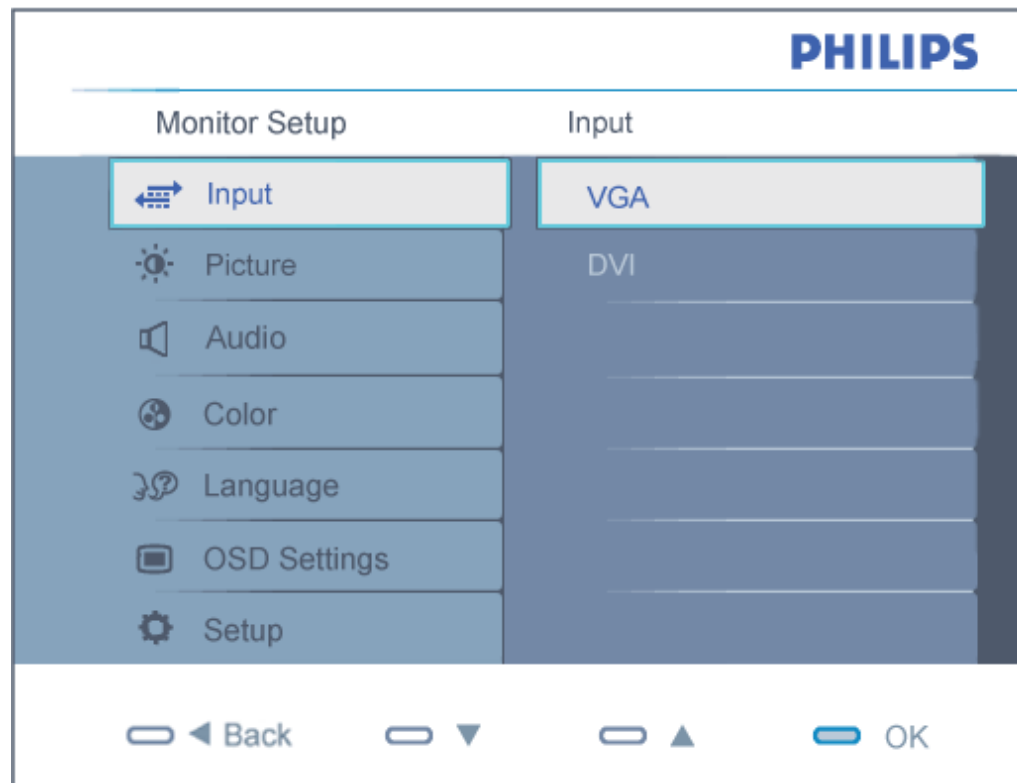

#### *Basic and simple instruction on the control keys.*

In the OSD shown above users can press ▼▲ buttons at the front bezel of the monitor to move the cursor, **OK** to confirm the choice or change.

[RETURN TO TOP OF THE PAGE](#)

## The OSD Tree

Below is an overall view of the structure of the On-Screen Display. You can use this as a reference when you want to work your way around the different adjustments later on.

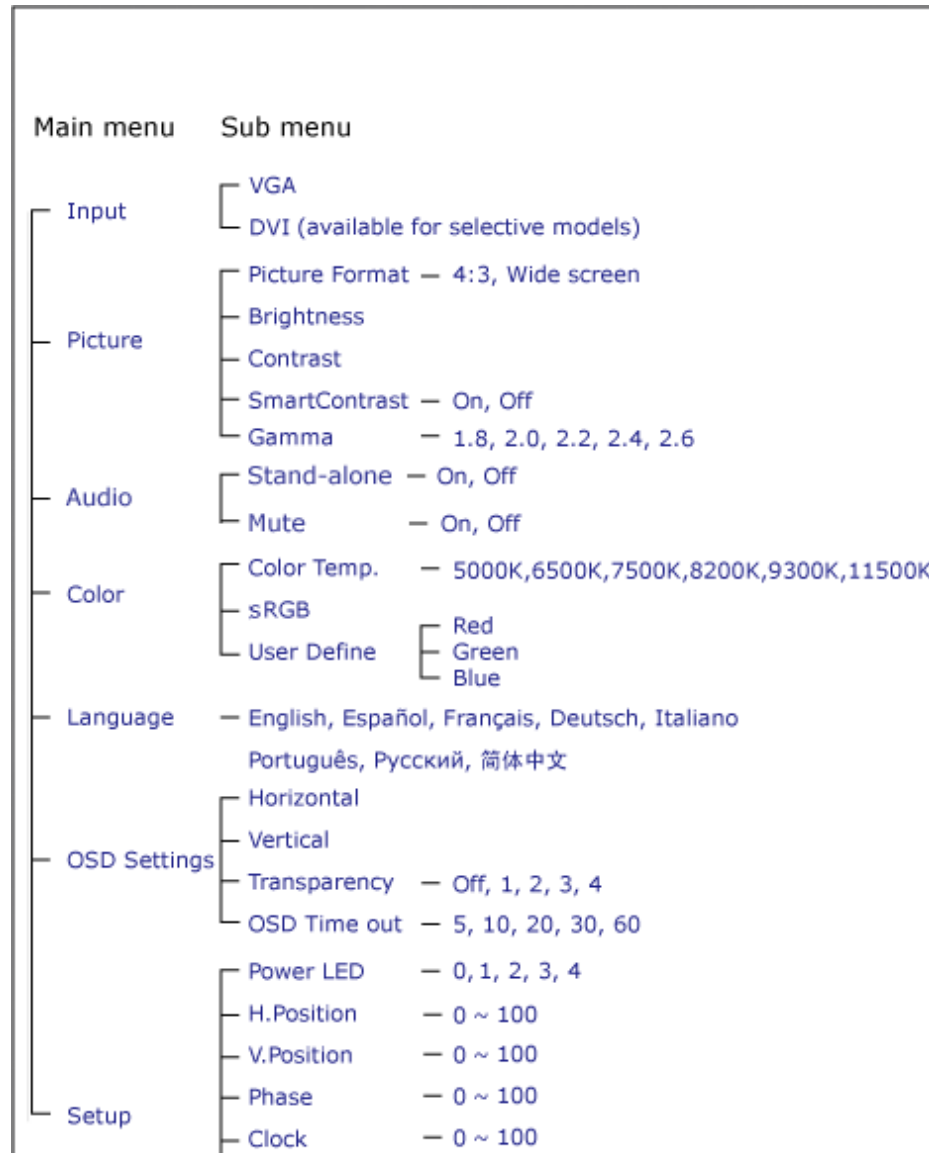



- Resolution Notification — On, Off
- Reset — Yes, No
- Information

### Resolution notification

This monitor is designed for optimal performance at its native resolution, 1680x1050@60Hz. When the monitor is powered on at a different resolution, an alert is displayed on screen: Use 1680x1050@60Hz for best results.

Display of the native resolution alert can be switched off from Setup in the OSD (On Screen Display) menu.

[RETURN TO TOP OF THE PAGE](#)

## Customer Care & Warranty

PLEASE SELECT YOUR COUNTRY/AREA TO REVIEW DETAILS OF YOUR WARRANTY COVERAGE

**WESTERN EUROPE:** • [Austria](#) • [Belgium](#) • [Denmark](#) • [France](#) • [Germany](#)  
• [Greece](#) • [Finland](#) • [Ireland](#) • [Italy](#) • [Luxembourg](#) • [the Netherlands](#) • [Norway](#)  
• [Portugal](#) • [Sweden](#) • [Switzerland](#) • [Spain](#) • [United Kingdom](#) • [Poland](#)

**EASTERN EUROPE:** • [Czech Republic](#) • [Hungary](#) • [Russia](#) • [Slovakia](#) • [Slovenia](#)  
• [Turkey](#)

**LATIN AMERICA:** • [Argentina](#) • [Brasil](#)

**NORTH AMERICA:** • [Canada](#) • [USA](#)

**PACIFIC:** • [Australia](#) • [New Zealand](#)

**ASIA:** • [China](#) • [Hong Kong](#) • [India](#) • [Indonesia](#) • [Korea](#) • [Malaysia](#) • [Pakistan](#)  
• [Philippines](#) • [Singapore](#) • [Taiwan](#) • [Thailand](#) • [Vietnam](#)

**AFRICA:** • [South Africa](#)

**MIDDLE EAST:** • [United Arab Emirates](#)

---

## Your Philips F1rst Choice Warranty

**Thank you for purchasing this Philips monitor.**



All Philips monitors are designed and manufactured to high standards and deliver high-quality performance, ease of use and ease of installation. Should you encounter any difficulties while installing or using this product, please contact the Philips helpdesk directly to benefit from your Philips F1rst Choice Warranty. This three-year service warranty entitles you to a swap model on-site if your monitor turns out to be faulty or defective. Philips aims at a swap within 48 hours of your call being received.

### What is covered?

The Philips F1rst Choice Warranty applies within Andorra, Austria, Belgium, Cyprus, Denmark, France, Germany, Greece, Finland, Ireland, Italy, Liechtenstein, Luxembourg, Monaco, the Netherlands, Norway, Poland, Portugal, Sweden, Switzerland, Spain and the United Kingdom and only for monitors originally designed, manufactured, approved and/or authorized for usage within these countries.

Warranty coverage begins as from the day you buy your monitor. *For three years thereafter*, your monitor will be swapped by at least an equivalent monitor in case of defects provided for under the warranty coverage.

The swap monitor remains yours and Philips keeps the defective/original monitor. For the swap monitor the warranty period remains equal to that of your original monitor, being 36 months as from the purchase date of your original monitor.

### What is excluded?

The Philips F1rst Choice Warranty applies provided the product is handled properly for its intended use, in accordance with its operating instructions and upon presentation of the original invoice or cash receipt, indicating the date of purchase, dealer's name and model and production number of the product.

The Philips F1rst Choice Warranty may not apply if:

- The documents have been altered in any way or made illegible;
- The model or production number on the product has been altered, deleted, removed or made illegible;
- Repairs or product modifications and alterations have been executed by unauthorized service organizations or persons;
- Damage is caused by accidents including but not limited to lightning, water or fire, misuse or neglect;

- Reception problems caused by signal conditions or cable or antenna systems outside the unit;
- Defects caused by abuse or misuse of the monitor;
- Product requires modification or adaptation to enable it to comply with local or national technical standards, which apply in countries for which the product was not originally designed, manufactured, approved and/or authorized. Therefore always check whether a product can be used in a specific country.
- Note that products that are not originally designed, manufactured, approved and/or authorized for usage within the Philips F1rst Choice countries, do not apply to the Philips F1rst Choice Warranty. In these cases the Philips global warranty terms are valid.

### Just a click away

In case of any problems, we advise you to read the operating instructions carefully or go to the [www.philips.com/support](http://www.philips.com/support) website for additional support.

### Just a phone call away

In order to avoid unnecessary inconvenience, we advise you to read the operating instructions carefully or go to the [www.philips.com/support](http://www.philips.com/support) website for additional support before contacting the Philips helpdesk.

To solve your problem quickly, please prepare the following details before contacting the Philips helpdesk:

- Philips type number
- Philips serial number
- Purchase date (copy of purchase may be required)
- PC environment Processor:
  - CUP and Graphic card name and driver version
  - Operating system
  - Application being used
- Other cards installed

Having the following information available will also help speed up the process:

- Your proof of purchase indicating: date of purchase, dealer name, model and product serial number.
- The full address to which the faulty monitor has to be collected and the swap model should be delivered.

Philips' customer help desks are located worldwide. Click here to access the [F1rst Choice Contact Information](#).

Or you can reach us via:

Website: <http://www.philips.com/support>



## First Choice Contact Information

Country	Code	Telephone number	Tariff
Austria	+43	0810 000206	€ 0.07
Belgium	+32	078 250851	€ 0.06
Denmark	+45	3525 8761	Local call tariff
Finland	+358	09 2290 1908	Local call tariff
France	+33	082161 1658	€ 0.09
Germany	+49	01803 386 853	€ 0.09
Greece	+30	00800 3122 1223	Free of charge
Ireland	+353	01 601 1161	Local call tariff
Italy	+39	840 320 041	€ 0.08
Luxembourg	+352	26 84 30 00	Local call tariff
The Netherlands	+31	0900 0400 063	€ 0.10
Norway	+47	2270 8250	Local call tariff
Poland	+48	0223491505	Local call tariff
Portugal	+351	2 1359 1440	Local call tariff
Spain	+34	902 888 785	€ 0.10
Sweden	+46	08 632 0016	Local call tariff
Switzerland	+41	02 2310 2116	Local call tariff
United Kingdom	+44	0207 949 0069	Local call tariff

## Your Guarantee in Central and Eastern Europe

Dear Customer,

Thank you for purchasing this Philips product, which has been designed and manufactured to the highest quality standards. If, unfortunately, something should go wrong with this product Philips guarantees free of charge labor and replacement parts during a period of 36 months from date of purchase.

### What is covered?

This Philips Guarantee in Central and Eastern Europe applies within Czech Republic, Hungary, Slovakia, Slovenia, Russia and Turkey and only for monitors originally designed, manufactured, approved and/or authorized for usage within these countries.

Warranty coverage begins as from the day you buy your monitor. *For 3 years thereafter*, your monitor will be serviced in case of defects provided for under the warranty coverage.

### What is excluded?

The Philips guarantee applies provided the product is handled properly for its intended use, in accordance with its operating instructions and upon presentation of the original invoice or cash receipt, indicating the date of purchase, dealer's name and model and production number of the product.

The Philips guarantee may not apply if:

- the documents have been altered in any way or made illegible;
- the model or production number on the product has been altered, deleted, removed or made illegible;
- repairs or product modifications and alterations have been executed by unauthorized service organizations or persons;
- damage is caused by accidents including but not limited to lightning, water or fire, misuse or neglect.
- Reception problems caused by signal conditions or cable or antenna systems outside the unit;
- Defects caused by abuse or misuse of the monitor;
- Product requires modification or adaptation to enable it to comply with local or national technical standards, which apply in countries for which the product was not originally designed, manufactured, approved and/or authorized. Therefore always check whether a product can be used in a specific country.

Please note that the product is not defective under this guarantee in the case where modifications

become necessary in order for the product to comply with local or national technical standards which apply in countries for which the product was not originally designed and/or manufactured. Therefore always check whether a product can be used in a specific country.

#### **Just a click away**

In case of any problems, we advise you to read the operating instructions carefully or go to the [www.philips.com/support](http://www.philips.com/support) website for additional support.

#### **Just a phone call away**

In order to avoid unnecessary inconvenience, we advise you to read the operating instructions carefully before contacting our dealers or Information Centers

In case your Philips product is not working correctly or is defective, please contact your Philips dealer or directly the [Philips Service and Consumer Information Centers](#)

Philips and the Philips Shield Emblem are registered trademarks of Koninklijke Philips Electronics N.V. and are used under license from Koninklijke Philips Electronics N.V.

Website: <http://www.philips.com/support>



## Consumer Information Centers

- Argentina • Australia • Brasil • Canada • New Zealand • Belarus • Bulgaria
- Croatia • Czech Republic • Estonia • United Arab Emirates • Hong Kong
- Hungary • India • Indonesia • Israel • Latvia • Lithuania • Malaysia
- Middle East + North Africa • New Zealand Pakistan • Romania • Russia
- Serbia & Montenegro • Singapore • Slovakia • Slovenia • South Africa
- South Korea • Taiwan • Philippines • Thailand • Turkey • Ukraine • Vietnam

### Eastern Europe

#### BELARUS

Technical Center of JV IBA  
M. Bogdanovich str. 155  
BY - 220040 Minsk  
Tel: +375 17 217 33 86

#### BELARUS

Service.BY  
Petrus Brovky st. 19 – 101-B  
220072, Minsk  
Belarus

#### BULGARIA

LAN Service  
140, Mimi Balkanska Str.  
Office center Translog  
1540 Sofia, Bulgaria  
Tel: +359 2 960 2360  
www.lan-service.bg

#### CZECH REPUBLIC

General Consumer Information Center  
800 142100

Xpectrum  
Lu.ná 591/4  
CZ - 160 00 Praha 6 Tel: 800 100 697 or 220 121 435  
Email: info@xpectrum.cz  
www.xpectrum.cz

## CROATIA

Renoprom d.o.o.  
Ljubljanska 4,  
Sv. Nedjelja, 10431  
Croatia  
Tel: +385 1 333 0974

## ESTONIA

FUJITSU SERVICES OU  
Akadeemia tee 21G  
EE-12618 Tallinn  
Tel: +372 6519900  
www.ee.invia.fujitsu.com

## HUNGARY

Serware Szerviz  
Vizimolnár u. 2-4  
HU - 1031 Budapest  
Tel: +36 1 2426331  
Email: [inbox@serware.hu](mailto:inbox@serware.hu)  
www.serware.hu

## HUNGARY

Profi Service Center Ltd.  
123 Kulso-Vaci Street,  
H-1044 Budapest ( Europe Center )  
Hungary

Tel: +36 1 814 8080  
[m.andras@psc.hu](mailto:m.andras@psc.hu)

## LATVIA

ServiceNet LV  
Jelgavas iela 36  
LV - 1055 Riga,  
Tel: +371 7460399  
Email: [serviss@servicenet.lv](mailto:serviss@servicenet.lv)

## LITHUANIA

ServiceNet LT  
Gaiziunu G. 3  
LT - 3009 KAUNAS  
Tel: +370 7400088  
Email: [servisas@servicenet.lt](mailto:servisas@servicenet.lt)  
www.servicenet.lt

## ROMANIA

Blue Ridge Int'l Computers SRL  
115, Mihai Eminescu St., Sector 2  
RO - 020074 Bucharest  
Tel: +40 21 2101969

## SERBIA & MONTENEGRO

Kim Tec d.o.o.  
Viline vode bb, Slobodna zona  
Beograd L12/3  
11000 Belgrade  
Serbia  
Tel. +381 11 20 70 684

## SLOVAKIA

General Consumer Information Center  
0800004551

Datalan Servisne Stredisko  
Puchovska 8  
SK - 831 06 Bratislava  
Tel: +421 2 49207155  
Email: servis@datalan.sk

## SLOVENIA

PC HAND  
Brezovce 10  
SI - 1236 Trzin  
Tel: +386 1 530 08 24  
Email: servis@pchand.si

## RUSSIA

CPS  
18, Shelepihinskaya nab.  
123290 Moscow  
Russia  
Tel. +7(495)797 3434

Profservice:  
14A -3, 2Karacharovskaya str,  
109202, Moscow ,  
Russia  
Tel. +7(095)170-5401

## TURKEY

Türk Philips Ticaret A.S.  
Yukari Dudullu Org.San.Bolgesi  
2.Cadde No:22  
34776-Umraniye/Istanbul  
Tel: (0800)-261 33 02

## UKRAINE

Comel  
Shevchenko street 32  
UA - 49030 Dnepropetrovsk  
Tel: +380 562320045  
www.csp-comel.com

LLC Topaz Company  
Topaz-Service Company,  
Mishina str. 3,  
Kiev  
Ukraine-03151

Tel: +38 044 245 73 31

## Latin America

### ARGENTINA

Azopardo 1480.  
(C1107ADZ) Cdad. de Buenos Aires  
Tel: 0800 3330 856  
Email: CIC.monitores@Philips.com

### BRASIL

Alameda Raja Gabaglia, 188 - 10°Andar - V.  
Olímpia - S. Paulo/SP - CEP 04551-090 -  
Brasil  
Tel: 0800-7254101  
Email: CIC.monitores@Philips.com

## Pacific

## AUSTRALIA

Company: AGOS NETWORK PTY LTD  
Address: 4/5 Dursley Road, Yennora, NSW 2161, Australia  
Tel: 1300 360 386  
Fax: +61-2-80808147  
Email: philips@agos.com.au  
Service hours: Mon.~Fri. 8:00am-7:30pm

## NEW ZEALAND

Company: Visual Group Ltd.  
Address: 28 Walls Rd Penrose Auckland  
Phone: 0800 657447  
Fax: 09 5809607  
E-mail: vai.ravindran@visualgroup.co.nz  
Service Hours: Mon.~Fri. 8:30am~5:30pm

## Asia

### HONG KONG/Macau

Company Name: PHK Service Limited  
Address: Flat A, 10/F., Pak Sun Building, 103 - 107 Wo Yi Hop Road, Kwai Chung, New Territories, Hong Kong  
Tel.: (852) 2610-6908 / (852) 2610-6929 for Hong Kong and (853) 2856-2277 for Macau  
Fax: (852) 2485 3574 for Hong Kong and (853) 2856 1498 for Macau  
E-mail: enquiry@phkservice.com.hk  
Service Hours: Mon.~Sat. 09:00am~06:00pm

### India

Company: REDINGTON INDIA LTD  
Address: SPL Guindy House, 95 Mount Road, Chennai 600032, India  
Tel: +9144-42243352/353  
E-mail: aftersales@in.aocmonitor.com  
Service hours: Mon.~Fri. 9:00AM~5:30PM; Sat. 9:00AM~1:00PM

## Indonesia

Company Name: PT. Gadingsari elektronika Prima  
Address: Kompleks Pinang 8, Jl. Ciputat raya No. 8F, Pondok Pinang. Jakarta  
Tel: 021-750909053, 021-750909056  
Fax: 021-7510982  
E-mail: [gepta@cbn.net.id](mailto:gepta@cbn.net.id)  
Service hours: Mon.~Fri. 8:30am~4:30pm; Sat. 8:30am~2:00pm

### Additional service points:

1. Philips Building Jl. Buncit Raya Kav 99. Jakarta Selatan.  
Phone: 021-7940040, ext 1722/1724, 98249295, 70980942

2. Jl. Tanah Abang 1 no 12S. Jakarta Pusat.  
Phone: 021-3455150, 34835453

3. Rukan City Home no H31, Gading Square. Jl. Bulevar Barat. Kelapa Gading. Jakarta Utara. Phone: 021-45870601, 98131424

## South Korea

Company: PCS One Korea Ltd.  
Address: 112-2, Banpo-dong, Seocho-ku, Seoul, 137-040, Korea  
Call Center Tel: 080-600-6600  
Tel: 82 2 591 1528  
Fax: 82 2 595 9688  
E-mail: [cic\\_korea@philips.com](mailto:cic_korea@philips.com)  
Service hours: Mon.~Fri. 9:00AM~ 6:00PM; Sat. 9:00AM~1:00PM

## Malaysia

Company: After Market Solutions (CE) Sdn Bhd  
Address: Lot 6. Jalan 225/51A, 46100 Petaling Jaya, Selangor DE, Malaysia.  
Phone: 603 7953 3370  
Philips Info Line: 1-800-880-180  
Fax: 603 7953 3338  
E-mail: [pceinfo.my@philips.com](mailto:pceinfo.my@philips.com)  
Service Hours: Mon.~Fri. 8:15am~5:15pm; Sat. 9:00am~1:00pm

## Pakistan

Philips Consumer Service  
Address: Mubarak manzil, 39, Garden Road, Saddar, Karachi-74400  
Tel: (9221) 2737411-16  
Fax: (9221) 2721167  
E-mail: [care@philips.com](mailto:care@philips.com)  
Website: [www.philips.com.p](http://www.philips.com.p)

### Singapore

Company: Philips Electronics Singapore Pte Ltd (Philips Consumer Care Center)  
Address: 620A Lorong 1 Toa Payoh, TP4 Building Level 1, Singapore 319762  
Tel: (65) 6882 3999  
Fax: (65) 62508037  
E-mail: [consumer.care.sg@philips.com](mailto:consumer.care.sg@philips.com)  
Service hours: Mon.~Fri. 9:00am~6:00pm; Sat. 9:00am~1:00pm

### Taiwan

Company: FETEC.CO  
Address: 3F, No.6, Lane 205, Sec. 1, Chang Hsing Rd, Lu Chu Hs, Taoyuan, Taiwan R.O.C 33800  
Consumer Care: 0800-231-099  
Tel: (03)2120336  
Fax: (03)3129184  
E-mail: [knlin08@xuite.net](mailto:knlin08@xuite.net)  
Service hours: Mon.~Fri. 8:30am~7:00pm

### Thailand

Company: Axis Computer System Co., Ltd.  
Address: 1421 Soi Lardprao 94, Srivara Town In Town Soi 3 Road, Wangthonglang, Bangkok 10310  
Thailand  
Tel: (662) 934-5498  
Fax: (662) 934-5499  
E-mail: [axis5@axiscomputer.co.th](mailto:axis5@axiscomputer.co.th)  
Service Hours: Mon.~Fri. 08:30am~05:30pm

### Vietnam

Company: Digiworld Corp  
Address: 211-213 Vo Van Tan St, Ward 5, Dist.3 , Ho Chi Minh city, Vietnam  
Tel: 848-38266065  
Fax: 848-38267307  
E-mail: [Digicare@dgw.com.vn](mailto:Digicare@dgw.com.vn)  
Service hours: 8:00 to 12:00 AM and 13:30 to 17:30 PM (from Monday to Friday)

### Philippines

Glee Electronics Inc  
Contact nos. (632) 636-3636 / 7064028 to 29  
Fax no. (632) 7064026

### Receiving Centers

NEO CARE - Megamall  
4th Level Cyberzone, Building B,  
SM Megamall, Mandaluyong City

NEO CARE - SM North EDSA

4th Level Cyberzone, Annex Bldg.  
SM City North EDSA, Quezon City  
441-1610

MDR Microware Sales Inc.  
Cebu Branch  
N. Escario corner Clavano St., Cebu City Phils.  
# 255-4415/ 255-3242/253-9361/4124864 to 67  
Sun # 0922-8210045 to 46

Davao Office:  
C. Arellano St., Davao City 8000  
082- 225-3021/225-3022  
Sun# 0922-8210015

CDO Office:  
1445 Corrales Ext.,CDO City  
088-856-8540/856-8541  
Sun # 0922-8210080

Iloilo Office:  
C. Lim Comp., Gomez St., Iloilo City  
# 033 338-4159/ 033 508-3741  
Sun # 0922-8808850

## Africa

### SOUTH AFRICA

Company name: Sylvara Technologies Pty Ltd  
Address: Ho Address Palm Springs Centre Christoffel Road Van Riebeeck Park Kempton Park, South Africa  
Tel: +27878084456  
Fax: +2711 391 1060  
E-mail: [customercare@philipssupport.co.za](mailto:customercare@philipssupport.co.za)  
Service hours: Mon.~ Fri. 08:00am~05:00pm

## Middle East



### Middle East + North Africa

Company: AL SHAHD COMPUTER L.L.C  
Address: P.O.BOX: 29024, DUBAI, UNITED ARAB EMIRATES  
TEL: 00971 4 2276525  
FAX: 00971 4 2276242  
E-mail: shahd52@eim.ae  
Service hours: Sat.~Thur. 9:00am~1:00pm & 4:00pm- 8:00pm

### Israel

Company: Eastronics LTD  
Address: 13 Rozanis St. P.O.B. 39300, Tel Aviv 61392 Israel  
Tel: 1-800-567000 call free in Israel; (972-50-8353722 after service hours until 20:00)  
Fax: 972-3-6458759  
E-mail: eastronics@eastronics.co.il  
Service hours: Sun.~Thurs. 08:00 - 18:00

## Your International Guarantee

Dear Customer,

Thank you for purchasing this Philips product which has been designed and manufactured to the highest quality standards.

If, unfortunately, something should go wrong with this product Philips guarantees free of charge labor and replacement parts irrespective of the country where it is repaired during a period of 12 months from date of purchase. This international Philips guarantee complements the existing national guarantee obligations to you of dealers and Philips in the country of purchase and does not affect your statutory rights as a customer.

The Philips guarantee applies provided the product is handled properly for its intended use, in accordance with its operating instructions and upon presentation of the original invoice or cash receipt, indicating the date of purchase, dealer's name and model and production number of the product.

The Philips guarantee may not apply if:

- the documents have been altered in any way or made illegible;
- the model or production number on the product has been altered, deleted, removed or made illegible;
- repairs or product modifications and alterations have been executed by unauthorized service organizations or persons;
- damage is caused by accidents including but not limited to lightning, water or fire, misuse or neglect.

Please note that the product is not defective under this guarantee in the case where modifications become necessary in order for the product to comply with local or national technical standards which apply in countries for which the product was not originally designed and/or manufactured. Therefore always check whether a product can be used in a specific country.

In case your Philips product is not working correctly or is defective, please contact your Philips dealer. In the event you require service whilst in another country a dealer address can be given to you by the Philips Consumer Help Desk in that country, the telephone and fax number of which can be found in the relevant part of this booklet.

In order to avoid unnecessary inconvenience, we advise you to read the operating instructions carefully before contacting your dealer. If you have questions which your dealer cannot answer or any related question please contact the [Philips Consumer Information Centers](#) or via:

Website: <http://www.philips.com>



## Your Philips F1rst Choice Warranty(USA)

Thank you for purchasing this Philips monitor.



All Philips monitors are designed and manufactured to high standards and deliver high-quality performance, ease of use and ease of installation. Should you encounter any difficulties while installing or using this product, please contact Philips directly to benefit from your Philips F1rst Choice Warranty. This three-year service warranty entitles you to a swap model on-site within 48 hours of your call being received within the first year of purchase. If you have any problems with your monitor within the second or third year of purchase, we will repair it after it has been sent to the service provider at your expense and returned to you within five working days, free of charge.

### LIMITED WARRANTY (Computer Monitor)

Click here to access the [Warranty Registration Card](#).

**Three Years Free Labor / Three Years Free Service on Parts / One Year Exchange\***

*\*Product will be exchanged with a new or renewed to original specifications unit within two business days for the first year. This product must be shipped in at your expense for service during years two and three.*

#### WHO IS COVERED?

You must have proof of purchase to receive warranty service. A sales receipt or other document showing that you purchased the product is considered proof of purchase. Attach it to this owner's manual and keep both nearby.

#### WHAT IS COVERED?

Warranty coverage begins the day you buy your product. *For three years thereafter*, all parts will be repaired or replaced, and labor is free. *After three years from the day of purchase*, you pay for the replacement or repair of all parts, and for all labor charges.

All parts, including repaired and replaced parts, are covered only for the original warranty period. When the warranty on the original product expires, the warranty on all replaced and repaired products and parts also expires.

#### WHAT IS EXCLUDED?

Your warranty does not cover:

- labor charges for installation or setup of the product, adjustment of customer controls on the product, and installation or repair of antenna systems outside of the product.
- product repair and/or part replacement because of misuse, accident, unauthorized repair or other cause not within the control of Philips Consumer Electronics.
- reception problems caused by signal conditions or cable or antenna systems outside the unit.
- a product that requires modification or adaptation to enable it to operate in any country other than the country for which it was designed, manufactured, approved and/or authorized, or repair of products damaged by these modifications.
- incidental or consequential damages resulting from the product. (Some states do not allow the exclusion of incidental or consequential damages, so the above exclusion may not apply to you. This includes, but is not limited to, prerecorded material, whether copyrighted or not copyrighted.)
- the model or production number on the product has been altered, deleted, removed or made illegible.

#### **Where IS SERVICE AVAILABLE?**

Warranty service is available in all countries where the product is officially distributed by Philips Consumer Electronics. In countries where Philips Consumer Electronics does not distribute the product, the local Philips service organization will attempt to provide service (although there may be a delay if the appropriate spare parts and technical manual(s) are not readily available).

#### **Where CAN I GET MORE INFORMATION?**

For more information, contact the Philips Customer Care Center by calling [\(877\) 835-1838 \(U.S.A. customers only\)](tel:8778351838) or [\(919\) 573-7855](tel:9195737855).

#### ***Before Requesting Service...***

Please check your owner's manual before requesting service. Adjustments of the controls discussed there may save you a service call.

#### **TO GET WARRANTY SERVICE IN U.S.A., PUERTO RICO OR U.S. VIRGIN ISLANDS...**

Contact the Philips Customer Care Center phone number listed below for product assistance and procedures for servicing:

*Philips Customer Care Center*

[\(877\) 835-1838](tel:(877)835-1838) or  [\(919\) 573-7855](tel:(919)573-7855)

*(In U.S.A., Puerto Rico and U.S. Virgin Islands, all implied warranties, including implied warranties of merchantability and fitness for a particular purpose, are limited in duration to the duration of this express warranty. But, because some states do not allow limitations on how long an implied warranty may last, this limitation may not apply to you.)*

### **TO GET WARRANTY SERVICE IN CANADA...**

Please contact Philips at:

[\(800\) 479-6696](tel:(800)479-6696)

Three years free parts and three years free labor will be provided at Philips Canada depot or any one of its authorized service centers.

*(In Canada, this warranty is given in lieu of all other warranties. No other warranties are expressed or implied, including any implied warranties of merchantability or fitness for a particular purpose. Philips is not liable under any circumstances for any direct, indirect, special, incidental or consequential damages, howsoever incurred, even if notified of the possibility of such damages.)*

**REMEMBER...** Please record the model and serial numbers found on the product below.

MODEL # \_\_\_\_\_

SERIAL # \_\_\_\_\_

*This warranty gives you specific legal rights. You may have other rights which vary from state/province to state/province.*

Before contacting Philips, please prepare the following details so we can solve your problem quickly.

- Philips type number
- Philips serial number
- Purchase date (copy of purchase may be required)
- PC environment Processor:
  - CUP and Graphic card name and driver version
  - Operating system
  - Application being used

- Other cards installed  
Having the following information available will also help speed up the process:
- Your proof of purchase indicating: date of purchase, dealer name, model and product serial number.
- The full address to which the swap model should be delivered.

### **Just a phone call away**

Philips customer help desks are located worldwide. Within the U.S. you can contact Philips customer care Monday-Friday from 8:00 AM-9:00 PM Eastern Time (ET) and on Saturdays from 10:00 AM-5:00 PM ET hrs by using one of the contact phone numbers.

For more information on this and more great Philips products visit our website at:

Website: <http://www.philips.com>

Installing your LCD monitor driver  
Download and Printing Instructions

## Download and Print

---

### Installing Your LCD monitor driver

*System requirements:*

- PC running Windows® 2000 , Windows® XP, Windows® Vista or later
- Find your driver ".inf/.icm/.cat" at : /PC/drivers/

**Read the "Readme.txt" file before installing.**

Add" refer to <http://www.p4c.philips.com/> to download the latest version of monitor drivers."

---

This page provides an option to read the manual in .pdf format. PDF files can be downloaded into your hard disk, then viewed and printed with Acrobat Reader or through your browser.

If you do not have Adobe® Acrobat Reader installed, click on the link to install the application.  
[Adobe® Acrobat Reader for PC](#) / [Adobe® Acrobat Reader for Apple Macintosh](#).

### **Download instructions:**

To download the file:

1. Click-and-hold your mouse over the icon below. (Windows® 95/98/2000/Me/XP/Vista users right-click)

Download  [220P1/220B1.pdf](#)

2. From the menu that appears, choose 'Save Link As...', 'Save Target As...' or 'Download Link to Disk'.

3. Choose where you would like to save the file; click 'Save' (if prompted to save as either 'text' or 'source', choose 'source').



***Printing instructions:***

To print the manual:

With the manual file open, follow your printer's instructions and print the pages you need.

[RETURN TO TOP OF THE PAGE](#)