

## MB4010T001 AutoScan Color Monitor

<b>English</b>	<b>Operating Instructions.....</b>	<b>2 - 13</b>
<b>Français</b>	<b>Mode d'emploi .....</b>	<b>14 - 25</b>
<b>Appendix</b>		
<b>English</b>	<b>Declaration FCC</b>	<b>... A1</b>
	<b>Information for Users in the U.S.</b>	<b>... A3</b>
	<b>Warranty</b>	<b>... A5</b>
<b>Deutsch</b>	<b>Hinweis / GS</b>	<b>... A4</b>
	<b>Achtung</b>	<b>... A6</b>
<b>Français</b>	<b>Declaration FCC</b>	<b>... A2</b>

### For Customer Use:

Enter below the Serial No. which is located on the back of the cabinet. Retain this information for future reference.

**Model No. MB4010T001**

---

**Serial No.**

---



 This "bolt of lightning" indicates that uninsulated material within your unit may cause an electrical shock. For the safety of everyone, do not remove product covering.

 This "exclamation point" calls attention to a feature for which you should read the enclosed literature carefully to prevent operating and maintenance problems.

## Introduction

The colour monitor displays sharp and brilliant images of text and graphics with a maximum resolution up to 1024x768 pixels. It is optimal for Windows, spread sheets, and any other application.

This monitor automatically scans horizontal frequencies from 30KHz to 54KHz, and vertical frequencies from 50Hz to 110Hz. With microprocessor based digital controlled circuit, the monitor can automatically adjust itself to the video card's scanning frequency and displays an image with precise parameters you desire. The wide range of scanning frequency supports variety of operating platforms, such as IBM PC and compatibles, including Intel based platforms such as 386, 486, Pentium and Pentium Pro.



## Feature Highlights

- **Global Styling** demonstrates a soft & smart image.
- **Digital Control** feature provides user-friendliness and ease-of-use when operating the monitor.
- **Anti-Glare** and **Anti-Static** screen coating eliminate any bad effects caused by the screen surface such as reflection of the room lights and dust attraction.
- **85Hz refresh rate:**  
The maximum display resolution is 1024 x 768 pixels non-interlaced mode. The recommended optimum resolution up to 800 x 600 pixels non-interlaced by maximum 85Hz refresh rate.
- **Green Design** including automatic power saving function (NUTEK) and low emission MPRII compliance shows our commitment in environmental care.
- **DDC1/DDC2B** allows communication between the monitor and PC system for optimal video configuration.

---

Note: If you experienced your monitor display is changing from color to mono, it's possible that you are using a non-VESA-DDC-standard video card. Please consult with your local Philips dealer for more information.

As an Energy Star Partner, MAGNAVOX, has determined that this product meets the Energy Star guidelines for energy efficiency.

IBM, IBM PC and Power PC are registered trademarks of International Business Machines Corporation.

---

---

## Safety precautions and maintenance

- ◆ Disconnect the monitor from the mains supply if the monitor is not to be used for an extended period of time.
- ◆ Do not attempt to remove the back cover, as you will be exposed to a shock hazard. The back cover should only be removed by qualified service personnel.
- ◆ Do not place objects on top of the monitor cabinet, which could fall into vents or which could cover them and prevent proper cooling of the monitor's electronic devices.
- ◆ Do not expose the monitor to rain or excessive moisture to avoid the risk of shock or permanent damage to the set.
- ◆ Do not use alcohol or ammonia based liquid to clean the monitor. If necessary, clean with a slightly damp cloth. Disconnect the monitor from the mains supply before cleaning.
- ◆ Consult a service technician if the monitor does not operate normally when operating instructions of this manual are followed.

## Package

Your package includes the following items:

- The monitor
- Pedestal
- Power cord
- Interface cable (flying-in)

## End of life disposal

Your new set contains materials which can be recycled and reused. Specialized companies can recycle your product to increase the amount of reusable materials and to minimize the amount of materials to be disposed of.

Please inform yourself on local regulations on disposal of your old set.

---

---

## Installation

**Important:** Please refer to the user's manuals of your computer and video adapter to make sure these equipments are properly installed and configured before installing the monitor.

### Positioning / Ventilation

- ◆ Avoid exposing the monitor to direct sunlight, stoves or any other heat sources.
- ◆ To prevent overheating, make sure that the ventilation openings of the monitor are not covered.
- ◆ Keep moisture and dust away.
- ◆ Keep away from any magnetic objects, such as speakers, electric motors, transformers, ...etc.
- ◆ When positioning this monitor, make sure that the mains plug and socket are easily accessible.

### Pedestal

With the built-in pedestal you can tilt and / or swivel the monitor for a most comfortable viewing angle.

To fit the pedestal, refer to the illustration on the inside back-cover of this manual.

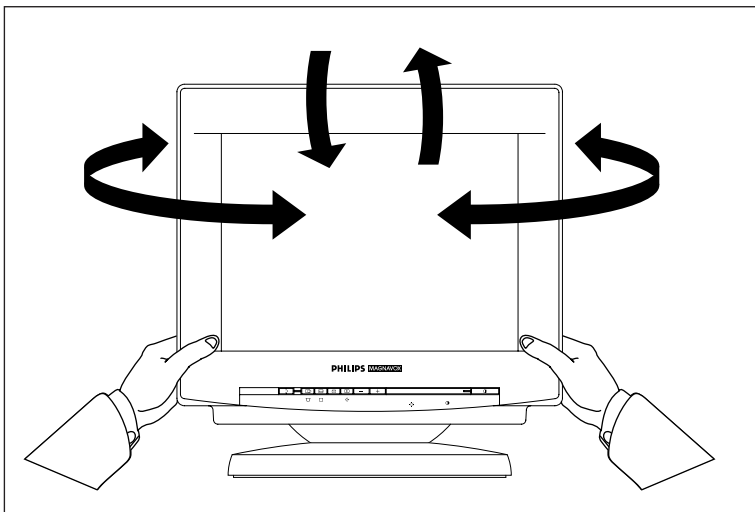

## Connection

**Important: Please make sure the AC power to your computer is “OFF” before connecting or disconnecting any display peripheral. Failure to do so may cause serious personal injury as well as permanent damage to your computer equipments.**

### Intel Based platform: 386, 486, Pentium, or other compatibles:

- Connect the monitor to the computer using the supplied interface cables.

Monitor rear view

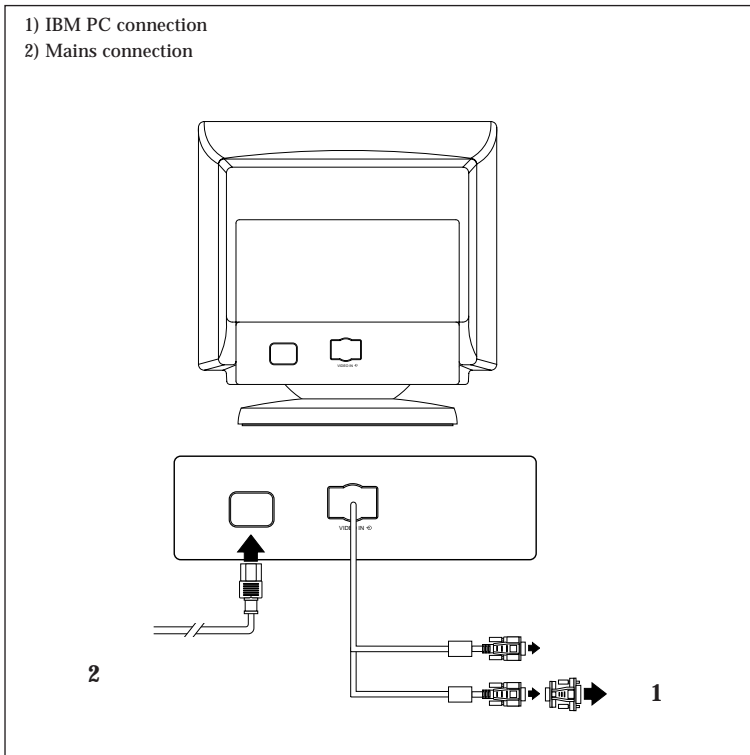

## Connection to the mains

(Rear of the monitor)

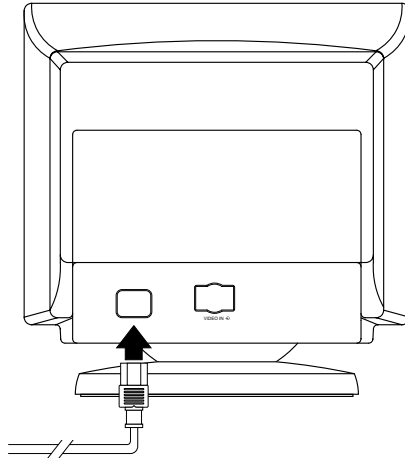

(Mains cord)

### Connecting to the mains

This monitor is set to operate at a mains supply of 100-240 volts AC . If the mains voltage in your home is not between this, consult your dealer.

Connect one end of the mains cord to the mains socket at the rear of monitor, and the other end to the mains supply.

The monitor will be operating in power saving mode if you switch on your monitor without signal input from PC. (Please refer to Power Management Signalling instruction.)

## Front Control locations and functions

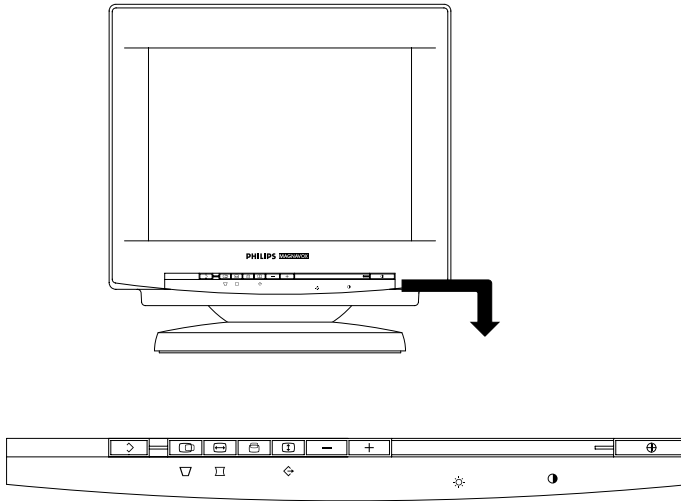

For an optimized adjustment of the picture following controls are available at the front.

### ① POWER.

- Press this knob, the green LED lights and the power is ON.
- Press this knob again, the green LED disappears and the power is OFF.

### ② CONTRAST

- Used to adjust the picture contrast level.

### ☀ BRIGHTNESS

- Used to adjust the overall screen brightness as a compensation for ambient light.





### "+" or "-"

- Press "+" or "-" to adjust the selected function.



---



**The function pads:**

-  H-Shift : to adjust the horizontal position of the image.
-  H-Size : to adjust the horizontal amplitude of the image.
-  V-Shift : to adjust the vertical position of the image.
-  V-Size : to adjust the vertical amplitude of the image.
-  **SHIFT key**
  - To select the level of function.

"Shift" LED off - Control is on first level

"Shift" LED on - Control is on second level

**Second level of the function pads:**

-  Trapezoid : to correct the trapezoid distortion of the image.
-  Pincushion : to correct the barrel distortion of the image
-  Recall : to recall original factory preset mode

**Remarks:**

1. When pressing any function pad, the "Shift" LED will flash once to indicate the function has been selected.
  2. Once the limit of the adjustable range has been reached, the shift LED will flash continuously.
-

## Adjustment

The monitor is pre-set with 8 modes for optimal display size and centering as indicated in the following table:

Mode	Resolution (dots x lines)	Horizontal Freq.(KHz)	Vertical Freq.(Hz)	Remark
VGA	640 x 350	31.5	70	Non-interlaced
VGA	640 x 400	31.5	70	Non-interlaced
VGA	640 x 480	31.5	60	Non-interlaced
VESA/75	640 x 480	37.5	75	Non-interlaced
VESA/60	800 x 600	37.8	60	Non-interlaced
VESA/75	800 x 600	46.9	75	Non-interlaced
VESA/60	1024 x 768	48.3	60	Non-interlaced
VESA/85	800 x 600	53.7	85	Non-interlaced

### (A) User mode: (15 modes)

- The set will save the user's setting parameters automatically. After 10 seconds of key-pad inactivity, the LED will flash twice to indicate the parameters being saved.

**(B) Power Management Signalling**

Power Management Definition					
VESA DPMS				POWER SAVING STATES	
MODE	VIDEO	H-SYNC	V-SYNC	POWER USED	POWER SAVING(%)
ON	Active	Yes	Yes	< 70 Watts	0 %
Stand-by	Blanked	No	Yes	< 15 Watts	> 82 %
Suspend	Blanked	Yes	No	< 15 Watts	> 82 %
OFF	Blanked	No	No	< 8 Watts	> 94 %

Note: The video will be blanked and the power LED color will change into following colors whenever the monitor goes into power management status.

Green LED light - "Normal" operation  
 Yellow LED light - "Stand by" or "Suspend" mode  
 Amber LED light - "OFF" mode

This monitor is Energy Star compliant when used with a computer equipped with DPMS. 

As an Energy Star Partner, MAGNAVOX, has determined that this product meets the Energy Star guidelines for energy efficiency.

**Remark:**

- The transition time from "on" mode to any power down mode will take around 5 seconds.
- The recovery time from "stand by" or "suspend" mode to "ON" mode will take around 3 seconds.

## Technical information

### (I) General:

Picture tube : 14 inch (35.5 cm), 90° deflection, non-glare, black matrix, light transmission 57%, phosphor P22 medium short, dotted pitch 0.28 mm.

#### Screen area

Recommended Display Area: 250 mm (H) x 188 mm (V)

Maximum Display Area : 274 mm (H) x 201 mm (V)

Line (Horizontal) frequency: 30 - 54 KHz (automatically)

Raster (Vertical) frequency : 50 - 110 Hz (automatically)

Mains voltage : 100 - 240 VAC , 60 - 50 Hz (automatically)

Power consumption : 70 watt nominal, 90 watt max.

Maximum dot rate : 65 MHz

Video input signal : 0.7 Vp-p linear / 75 Ohm

Sync type : Separate H,V, TTL level

Sync Polarity : Positive or Negative

Pedestal : Tilt - 5° forward, 13° backward; swivel - 90° leftward or rightward.

Unit dimension (W x H x D) : 356 x 370 x 382 mm

Net weight : 10.6 Kg

#### Operating condition

Temperature : 0° C to 40° C

Humidity : 20% to 80%

#### Storage condition

Temperature : -25° C to 70° C

Humidity : 20% to 95%

DDC1/DDC2B : VESA standard

### (II) Compatibility:

- . Intel based platform (386, 486, Pentium) and other compatibles.
- . VESA Guide lines and Standards.

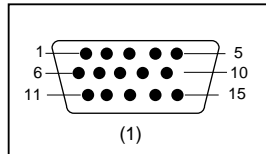
**(III) Pin assignment:**

(1) The 15-pin D-sub connector (male) of the signal cable (IBM systems):

Pin No.	Assignment	Pin No.	Assignment
1	Red video input	9	No pin
2	Green video input	10	Logic ground
3	Blue video input	11	Identification output - connected to pin 10
4	Identification output - Connected to pin 10	12	Serial data line (SDA)
5	Ground	13	H. Sync
6	Red video ground	14	V. Sync (VCLK for DDC)
7	Green video ground	15	Data clock line (SCL)
8	Blue video ground		

\* Because of a policy of continuous product improvement, the above specifications are subject to change without notice.