

cineos™  
HDTV Monitor

## Your Television's Directions for Use

**55PL9224**  
**55PL9524**  
**62PL9524**

### Highlights

- **Liquid-crystal-on-silicon (LCOS) High-definition Imaging**
- **High-resolution Display—1280 x 720 pixels**

### Features

- Digital Natural Motion™
- Active Control™—analyzes and adjusts incoming signal
- Two-tuner, Double-window PIP (Picture-in-Picture)
- Dolby® Virtual Surround, 30-watt RMS
- 3D Y/C Comb Filter
- HD Component and DVI Input
- Side AV Convenience Jacks
- Matching stand and swivel available



Refer to the **Quick Use and Setup Guide** (supplied with your TV) for information on basic connections, remote control button descriptions, on-screen menu language, and Autoprogram.

**PHILIPS**

# Return your Product Registration Card today to get the very most from your purchase.

Registering your model with PHILIPS makes you eligible for all of the valuable benefits listed below, so don't miss out. Complete and return your Product Registration Card at once to ensure:

## \*Proof of Purchase

Returning the enclosed card guarantees that your date of purchase will be on file, so no additional paperwork will be required from you to obtain warranty service.

## \*Product Safety Notification

By registering your product, you'll receive notification - directly from the manufacturer - in the rare case of a product recall or safety defect.

## \*Additional Benefits of Product Ownership

Registering your product guarantees that you'll receive all of the privileges to which you're entitled, including special money-saving offers.

# PHILIPS

***Congratulations on your purchase,  
and welcome to the "family!"***

### **Dear PHILIPS product owner:**

Thank you for your confidence in PHILIPS. You've selected one of the best-built, best-backed products available today. We'll do everything in our power to keep you happy with your purchase for many years to come.

As a member of the PHILIPS "family," you're entitled to protection by one of the most comprehensive warranties and outstanding service networks in the industry. What's more, your purchase guarantees you'll receive all the information and special offers for which you qualify, plus easy access to accessories from our convenient home shopping network.

Most importantly, you can count on our uncompromising commitment to your total satisfaction.

All of this is our way of saying welcome - and thanks for investing in a PHILIPS product.

**P.S. To get the most from your PHILIPS purchase, be sure to complete and return your Product Registration Card at once.**

Know these  
**safety** symbols

 This "bolt of lightning" indicates uninsulated material within your unit may cause an electrical shock. For the safety of everyone in your household, please do not remove product covering.

 The "exclamation point" calls attention to features for which you should read the enclosed literature closely to prevent operating and maintenance problems.

**CAUTION:** To prevent electric shock, match wide blade of plug to wide slot, fully insert.

**ATTENTION:** Pour éviter les choc électriques, introduire la lame la plus large de la fiche dans la borne correspondante de la prise et pousser jusqu'au fond.

### **For Customer Use**

Enter below the Serial No. which is located on the rear of the cabinet. Retain this information for future reference.

Model No. \_\_\_\_\_

Serial No. \_\_\_\_\_

Visit our World Wide Web Site at <http://www.philips.com>

# IMPORTANT SAFETY INSTRUCTIONS

## Read before operating equipment

1. Read these instructions.
2. Keep these instructions.
3. Heed all warnings.
4. Follow all instructions.
5. Do not use this apparatus near water.
6. Clean only with a dry cloth.
7. Do not block any of the ventilation openings. Install in accordance with the manufacturers instructions.
8. Do not install near any heat sources such as radiators, heat registers, stoves, or other apparatus (including amplifiers) that produce heat.
9. Do not defeat the safety purpose of the polarized or grounding-type plug. A polarized plug has two blades with one wider than the other. A grounding type plug has two blades and third grounding prong. The wide blade or third prong are provided for your safety. When the provided plug does not fit into your outlet, consult an electrician for replacement of the obsolete outlet.
10. Protect the power cord from being walked on or pinched particularly at plugs, convenience receptacles, and the point where they exit from the apparatus.
11. Only use attachments/accessories specified by the manufacturer.
12.  Use only with a cart, stand, tripod, bracket, or table specified by the manufacturer, or sold with the apparatus. When a cart is used, use caution when moving the cart/apparatus combination to avoid injury from tip-over.
13. Unplug this apparatus during lightning storms or when unused for long periods of time.
14. Refer all servicing to qualified service personnel. Servicing is required when the apparatus has been damaged in any way, such as power-supply cord or plug is damaged, liquid has been spilled or objects have fallen into apparatus, the apparatus has been exposed to rain or moisture, does not operate normally, or has been dropped.
15. This product may contain lead and mercury. Disposal of these materials may be regulated due to environmental considerations. For disposal or recycling information, please contact your local authorities or the Electronic Industries Alliance: [www.eiae.org](http://www.eiae.org)
16. **Damage Requiring Service** - The appliance should be serviced by qualified service personnel when:
  - A. The power supply cord or the plug has been damaged; or
  - B. Objects have fallen, or liquid has been spilled into the appliance; or
  - C. The appliance has been exposed to rain; or
  - D. The appliance does not appear to operate normally or exhibits a marked change in performance; or
  - E. The appliance has been dropped, or the enclosure damaged.
17. **Tilt/Stability** - All televisions must comply with recommended international global safety standards for tilt and stability properties of its cabinet design.
  - Do not compromise these design standards by applying excessive pull force to the front, or top, of the cabinet which could ultimately overturn the product.
  - Also, do not endanger yourself, or children, by placing electronic equipment/toys on the top of the cabinet. Such items could unsuspectingly fall from the top of the set and cause product damage and/or personal injury.
18. **Wall or Ceiling Mounting** - The appliance should be mounted to a wall or ceiling only as recommended by the manufacturer.
19. **Power Lines** - An outdoor antenna should be located away from power lines.
20. **Outdoor Antenna Grounding** - If an outside antenna is connected to the receiver, be sure the antenna system is grounded so as to provide some protection against voltage surges and built up static charges. Section 810 of the National Electric Code, ANSI/NFPA No. 70-1984, provides information with respect to proper grounding of the mast and supporting structure, grounding of the lead-in wire to an antenna discharge unit, size of grounding connectors, location of antenna-discharge unit, connection to grounding electrodes, and requirements for the grounding electrode. See Figure below.
21. **Object and Liquid Entry** - Care should be taken so that objects do not fall and liquids are not spilled into the enclosure through openings.
  - a) **Warning:** To reduce the risk of fire or electric shock, this apparatus should not be exposed to rain or moisture and objects filled with liquids, such as vases, should not be placed on this apparatus.
22. **Battery Usage CAUTION** - To prevent battery leakage that may result in bodily injury, property damage, or damage to the unit:
  - Install all batteries correctly, with + and - aligned as marked on the unit.
  - Do not mix batteries (old and new or carbon and alkaline, etc.).
  - Remove batteries when the unit is not used for a long time.

**Note to the CATV system installer:** This reminder is provided to call the CATV system installer's attention to Article 820-40 of the NEC that provides guidelines for proper grounding and, in particular, specifies that the cable ground shall be connected to the grounding system of the building, as close to the point of cable entry as practical.

### Example of Antenna Grounding as per NEC - National Electric Code

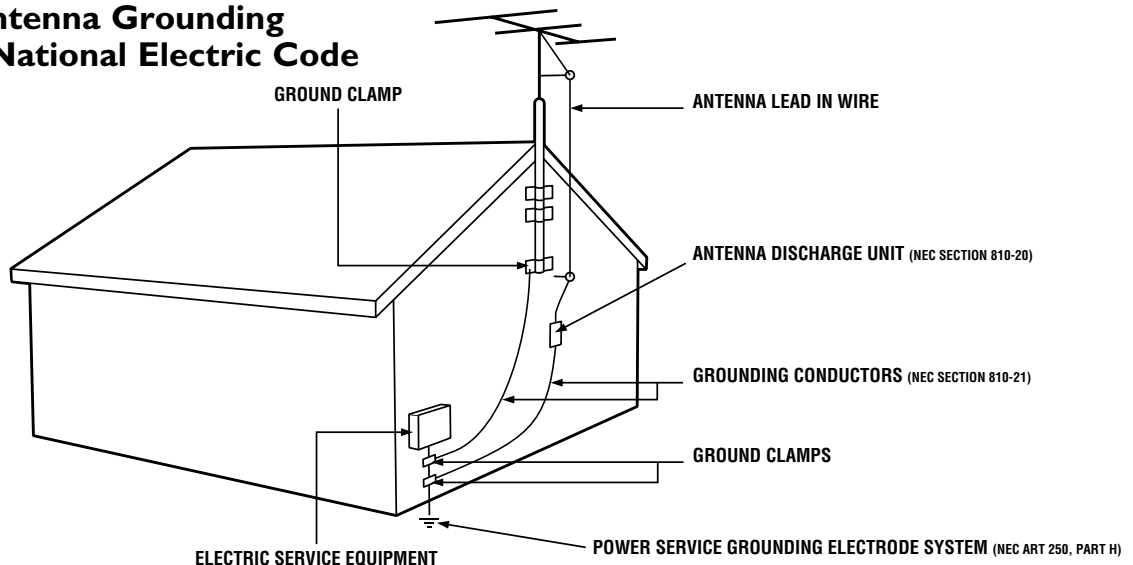

# Contents

## INTRODUCTION

Welcome/Registration of Your TV	.2
Safety/Precautions	.3
Features	.5

## CONNECTING ACCESSORY DEVICES TO YOUR TV

Information about TV Signals	.6
Descriptions of Jacks, Cables, and Connectors	.7
Panel Jack Compatibility Information	.8
Pre-connection Recommendations	.9
Connecting a VCR	.10
Connecting a VCR and Cable Box	.11
Connecting an S-Video Device	.12
Connecting a Standard DVD Player	.13
Connecting a Progressive-scan DVD Player	.14
Connecting an HD Satellite Receiver to YPbPr	.15
Connecting an HD Satellite Receiver to DVI	.16
Connecting Surround Sound Equipment	.17
Connecting to the Side Inputs: Video Game System	.18
Labeling the Audio/Video Input Sources	.19

## USING THE REMOTE CONTROL

Remote Control Buttons	.20-21
Programming the Remote Control	.22-23
Programming the Remote Control: Set-up Codes	.24-25
Operating Accessory Devices with the TV Remote	.26-27
Using Active Control™ Plus	.28

## USING THE ON-SCREEN MENUS

### PICTURE

Adjusting/Setting the Picture Controls	.29
Selecting a Digital Processing Option	.30
Selecting a Dynamic Contrast Option	.31
Selecting a DNR (Dynamic Noise Reduction) Option	.32
Turning on Color Enhancement	.33
Selecting an AutoPicture™ Option	.34
Selecting a Picture Format Option	.35-36

### SOUND

Adjusting the TV and Headphone Volume	.37
Selecting a TV Equalizer Option	.38
Adjusting TV Speaker Balance	.39
Turning Loudness on or off	.40
Selecting a Sound Mode Option	.41
Using Alternate Audio (SAP)	.42

Setting the TV for Stereo Programming	.43
Turning the AVL (Audio Volume Leveler) on or off	.44
Adjusting the Delta Volume	.45
Selecting an AutoSound™ Option	.46

## FEATURES

Using Closed Captioning	.47
Setting the Sleptimer	.48
Setting the On Timer	.49

## CHANNELS

Using the Channel List	.50
Removing Channels from the Channel List	.51
Using Lock Channel	.52
Using Lock After	.53
Blocking Programming Based on TV Ratings	.54
Blocking Programming Based on Movie Ratings	.55
Turning the Antenna Attenuator on or off	.56

## GENERAL

Using Surf	.57
Using Dual Screen and PIP	.58
Changing Channels or Input Sources in Dual Screen/PIP	.59
Selecting a Picture Freeze Option	.60
Resetting the Audio/Video Settings to Factory Default Values	.61
Selecting an On-screen Display Option	.62
Setting up or Changing a PIN (Personal Identification Number)	.63
Setting the Subwoofer Control	.64
Setting the Clock—Auto Clock Mode	.65
Setting the Clock Manually	.66
Selecting a Time Zone and Setting the Daylight Savings Control	.67
Using Installation Features: Language and Autoprogram	.68

## ADDITIONAL INFORMATION

Cleaning the TV	.69
Cleaning or Replacing the Filters	.70
Replacing the Lamp	.71-72
Resetting the Lamp's Lifetime Counter	.73
Troubleshooting	.74-75
Product Specifications	.76
Index	.77
Limited Warranty	.80

## Features

### Compact design with low weight

The unique Philips single-panel liquid-crystal-on-silicon (LCOS) technology allows for a large screen TV with a very low depth and low weight. This TV will find a place in any living room without occupying a large area, and it can be easily handled by two persons.

### Philips Single-panel LCOS Imaging System

The Philips single-panel LCOS technology produces unmatched high-resolution and flicker-free video with superb brightness. This technology enables a large-screen-size TV with low weight and shallow depth without any concerns for convergence or image retention.

### Digital Natural Motion™

Digital Natural Motion™ offers razor-sharp reproduction of movement and motion. Its unique and highly advanced processing calculates motion trajectories of moving picture elements. It corrects jerky movement from both studio programs or movie material.

### ActiveControl™ Plus

Active Control™ Plus automatically analyzes the incoming signals from the Tuner, AV1, AV2, and Side video inputs 50 times per second and adjusts key picture settings. In addition to measuring picture noise, this feature uses an ambient light sensor to adjust the picture settings according to viewing conditions in the room.

### Dolby\* Virtual Surround

Dolby processing circuitry provides an enhanced cinema surround sound effect without the need for rear speakers.

### Double-window, Two-Tuner PIP

Your TV features double-window, two-tuner PIP with second tuner double window. The TV also has single PIP (free positioning), as well as threefold and sixfold side PIPs. In addition, you get photo finish, freeze Main, and freeze PIP. Replay lets you play back the previous few seconds in a PIP screen—if you missed the action, replay it as much as you want.

### Audio/Video (A/V) Jack Panel

The A/V jack panel allows direct connections with VCRs, DVDs, high-definition receivers, or other devices, providing quality TV picture and sound playback.

### Audio Volume Leveler (AVL) Control

AVL keeps the TV sound at an even level. Peaks and valleys that occur at commercial breaks or during program changes are reduced, providing a more consistent, comfortable sound.

### V-Chip (with Channel Lock)

The V-Chip feature (with Channel Lock) will allow you to block the viewing of channels or programs with certain ratings, and thus prevent your children from watching inappropriate materials.

### Autoprogramming

The TV's Autoprogram feature searches (when activated) for all available channels from regular antenna or cable signals and stores active broadcast stations in the TV's memory.

### Surf Button

Philips Auto Surf™ allows you to easily switch between only the channels that are of interest to you. Surf allows two-channel surfing or nine-channel surfing.

## Items Included with This TV

As you unpack your TV, please note the included items:

- *Quick Use and Setup Guide* to help you set up your new TV.
- *Directions for Use* manual—contains information on safety, set maintenance, Factory Service Center locations, and product warranty
- Warranty Registration Card
- Remote Control (with supplied batteries).

Please take a few minutes to complete your registration card. The serial number for the TV is on the rear of the set. For your future reference, please write down the serial and model number of this television in the space provided on the warranty page at the back of this manual. (In the unlikely event you should need to place a service call, these numbers will be needed.)

## End-of-Life Disposal

Your new television and its packing contain materials that can be recycled and reused. Specialized companies can recycle your product to increase the amount of reusable materials and minimize the amounts that need to be properly disposed of. Your product also uses batteries that should not be thrown away when depleted, but should be handed in and disposed of as small chemical waste.

When you replace your existing equipment, please find out about the local regulations regarding disposal of your old television, batteries, and packing materials.



As an Energy Star® Partner, Philips Consumer Electronics has determined this product meets the Energy Star® guidelines for energy efficiency.

Energy Star® is a U.S. registered mark. Using products with the Energy Star® label can save energy. Saving energy reduces air pollution and lowers utility bills.

\*Manufactured under license from Dolby Laboratories. "Dolby" and the double-D symbol are trademarks of Dolby Laboratories.

Active Control, AutoPicture, AutoSound, AutoSurf, Cineos, Digital Crystal Clear, Digital Natural Motion, and Pixel Plus are trademarks of Philips Consumer Electronics. Copyright 2004 Philips Consumer Electronics. All rights reserved.



# Ways TV Signals Can Come to Your Home

## Over the Air

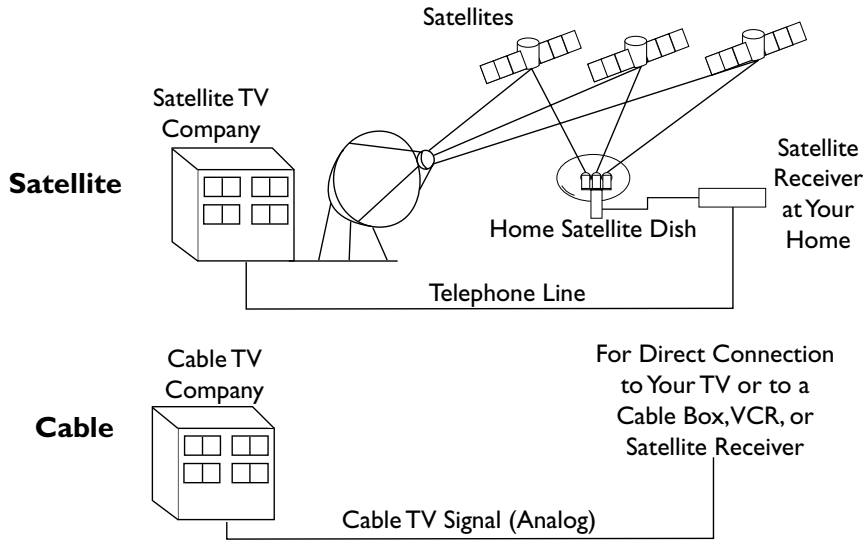
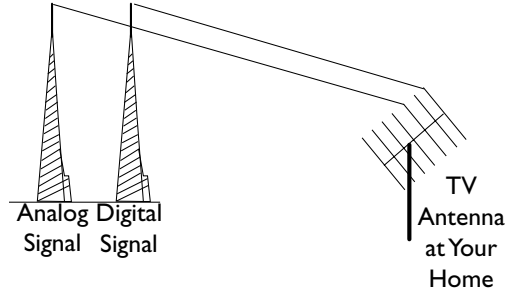

## Your High-definition-ready Set

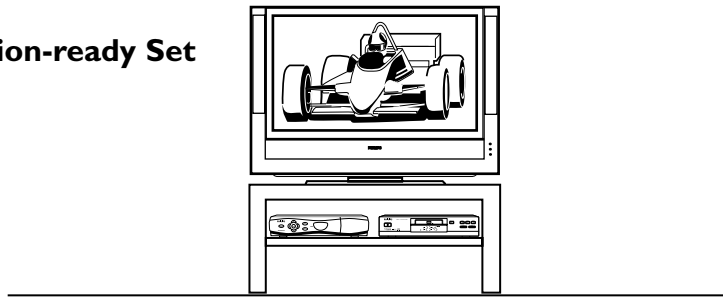

**High-definition television offers a picture with unprecedented crispness and clarity.** The TV broadcast industry is moving toward high definition as the signal standard. Currently, the number of programs being broadcast in high definition is limited, but this is changing. To view high-definition programs on your TV, you will need to connect a satellite receiver, cable box, or set-top box that can decode HD signals.

### Resolution information

Image resolutions are commonly referred to by a number followed by a letter: 480i, 480p, 720p and 1080i. The number in each format refers to the number of lines of resolution, so for example both 480i and 480p offer 480 lines of resolution. The "i" or "p" refers to whether the signal is displayed using respectively interlaced or progressive scan. Interlaced scan breaks each frame of video into 2 fields, one made up of even lines and one made up of odd lines. The image is reproduced by drawing all odd lines first (1,3,5,...479) than all the even ones (2,4,6,...,480). Progressive scan, on the other hand reproduces an image by drawing all lines in succession (1,2,3,4,...480).

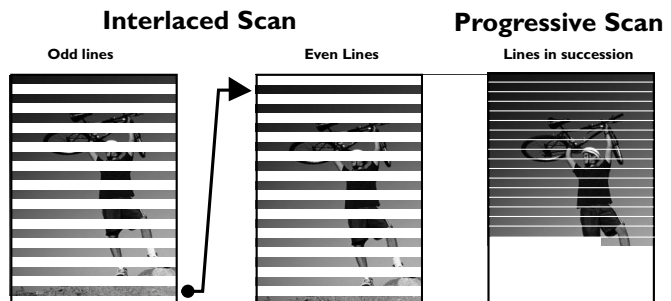

# Descriptions of Jacks, Cables, and Connectors



This page contains descriptions and illustrations of jacks, cables, and connectors you might use in making connections. The cables and connectors are not supplied with your TV, but you can purchase at your electronics dealer. Or you can order them by calling our Customer Care Center at 1-800-531-0039.

## DVI-D Input Jack

**Cable used: DVI-D**

This jack works only with DVI TMDS (Transition Minimized Differential Signaling) digital video. Allows encrypted transmissions of uncompressed digital content. The DVI-D jack used in this product is not for computer connections.

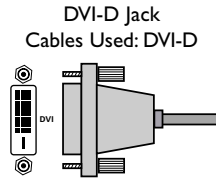

## Component Video Input Jacks

**Cables used: component video with RCA-type phono plugs**

Allow you to connect accessory devices such as DVD players. Separating the video into three signals, these inputs provide excellent quality. Be sure to connect the left and right audio cables, because the Y, Pb, Pr jacks receive only the picture signal.

**NOTE:** See the "Helpful Hint" on page 13 for more information.

Component Video Jacks  
Cables Used: Component Video with RCA-type Phono Plugs

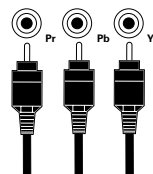

## S-Video Input Jacks

**Cable used: S-Video**

Provide a higher quality picture than the Video (composite) jacks because the color part of the picture is separated from the black and white portion. Be sure to connect the left and right audio cables, because the S-Video jacks receive only the picture signal.

S-VIDEO Jack  
Cable Used: S-Video

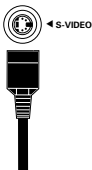

## RGB+HV Input Jack

**Cable used: HD DB15**

Allows you to connect equipment with RGB or VGA output.

VGA/HD15 Jack  
Cable Used: HD DB15

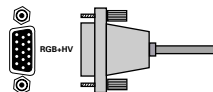

## Video (called "CVBS" or "composite") Input Jacks

**Cable used: Video with RCA-type phono plugs**

Provide better picture performance than the antenna RF input. Be sure to connect the audio cables, because the video jacks receive only the picture signal.

Your TV also has a monitor output ("MON OUT") video ("V") jack. Use a video cable with RCA-type phone plugs to make connections.

Video (Composite) Jack  
Cable Used: Video with RCA-type Phono Plugs

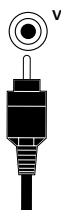

## Tuner (RF) Input Jack

### Cables used: RF coaxial cable (75Ω)

Allows you to connect an antenna, cable TV, or components having RF outputs to the antenna input on the TV. RF coaxial cables are available in push-on or screw-on type.

Antenna RF Jack  
Cable Used: RF Coaxial (75Ω)

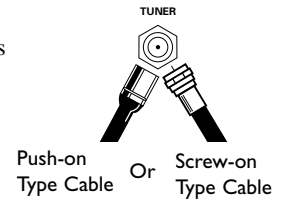

## Signal Splitter

Allows you to route an antenna or cable TV signal to two inputs.

Signal Splitter  
Cables Used: RF Coaxial (75Ω)

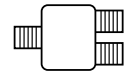

## 300- to 75-ohm Twin-lead Adapter

Accepts twin-lead wires from an antenna and allows connection to the antenna input on the TV. If your antenna is already equipped with an RF coaxial cable you will not need this adapter.

300- to 75-ohm Twin-lead Adapter

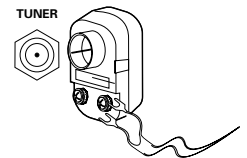

## Audio Input Jacks

### Cables used: Audio with RCA-type phono plugs

Provide sound for the video inputs. If your accessory device has only one output for audio, connect it to the left (color coded white) audio jack on the TV.

Your TV also has monitor output ("MON OUT") audio ("L" and "R") jacks and a subwoofer output ("SUB OUT") jack. Use an audio cable with RCA-type phone plugs to make connections.

Audio Jacks  
Cables Used: Audio with RCA-type Phono Plugs

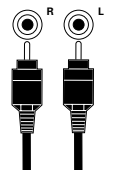

## 3.5mm Stereo Mini Phone Plug to RCA Jack Adapter

Allows a connection between the 3.5mm stereo audio out jack on a computer and the left and right audio inputs on the television. Connect A/V cables with RCA-type phono plugs to the adapter, then to the TV.

3.5mm Stereo Mini Phone Plug to RCA Jack Adapter

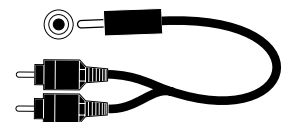



# Panel Jack Compatibility Information

**1 AV 1 Input Jacks**  
**Signals accepted:** NTSC (480i).  
**Inputs available:** YPbPr, S-Video (Y/C), and CVBS, plus audio left and right.  
**Use only one of the video signal inputs at a time.** If you should forget and have more than one type of signal connected, the set will automatically show the one of better quality: CVBS—good, S-Video—better, and YPbPr—best. For sound, connections must be made to the AV1 audio inputs.

**2 MON OUT Output Jacks**  
 Provide video and audio output signals from all TV when those sources are being viewed on the main screen. Output from the audio L/R jacks is at a fixed volume level; changing the TV volume does not affect them. Adjust the volume at your external home cinema system.

**3 AV 2 Input Jacks**  
**Signals accepted:** NTSC (480i).  
**Inputs available:** S-Video (Y/C) and CVBS, plus audio left and right.  
**Use only one of the video signal inputs at a time.** If you should forget and have both types of signal connected, the set will automatically show the S-Video, since it is of better quality than CVBS. For sound, connections must be made to the AV2 audio inputs.

**4 SUB OUT Output Jack**  
 Provides a signal to an external powered subwoofer.

**5 AV3 Input Jacks**  
**Signals accepted:** NTSC (480i), 480p, 720p, and 1080i, plus audio left and right.  
**Inputs available:** YPbPr, plus audio. For sound, connections must be made to the AV3 audio inputs.

**6 AV4 Input Jacks**  
**Signals accepted:** NTSC (480i), 480p, 720p, and 1080i, plus audio left and right.  
**Inputs available:** YPbPr, plus audio. For sound, connections must be made to the AV4 audio inputs.

**7 TUNER Input Jack**  
**Signals accepted:** RF modulated NTSC.  
**Inputs available:** 75Ω RF coaxial.

**8 AV5 Input Connectors**  
**Signals accepted:** NTSC (480i), 480p, 720p, 1080i, and VGA plus audio left and right.  
**Inputs available:** RGB+HV. For sound, connections must be made to the AV5 audio inputs.

**9 AV6 Input Connectors**  
**Signals accepted:** Digital only (TMDS [Transition Minimized Differential Signaling] encoded, uncompressed); DVI 480i, 480p, 720p, and 1080i, plus audio left and right.  
**Inputs available:** DVI TMDS, plus audio. For sound, connections must be made to the AV6 audio inputs.  
**Intended use of the input:** digital set-top boxes and inputs from other digital video devices.  
**NOTE: This DVI jack is not for computer connections. VGA cannot be connected.**

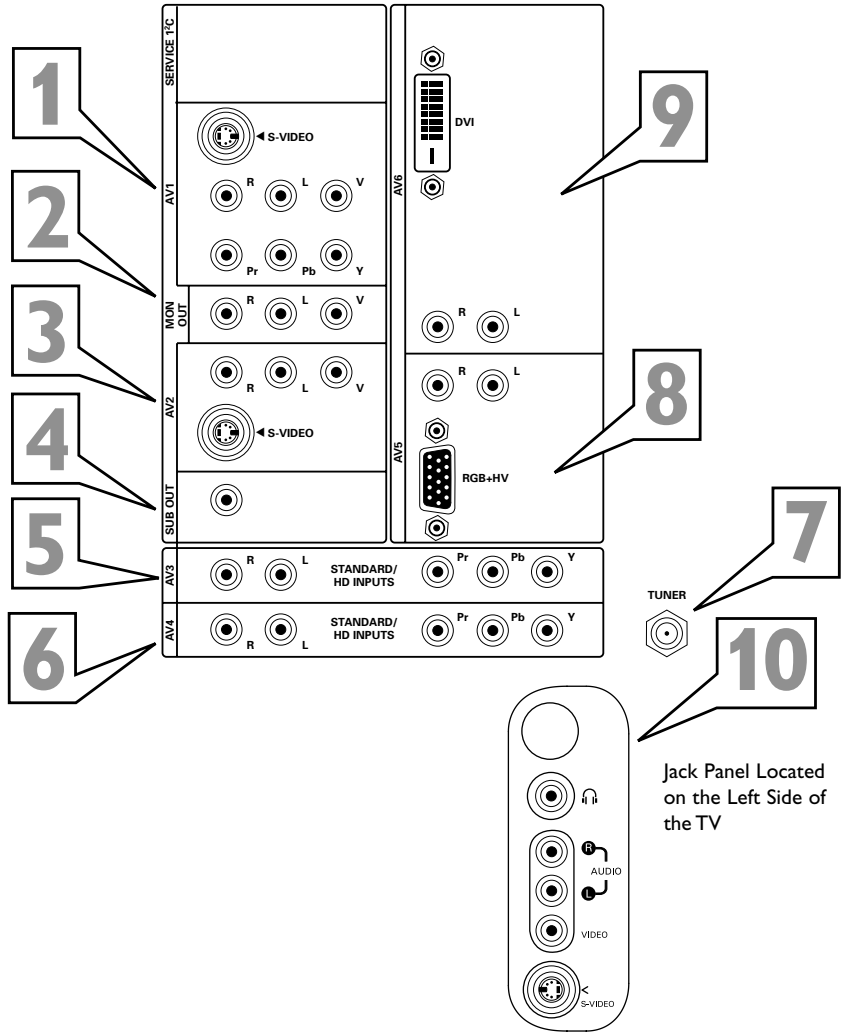

**Definitions:**  
**NTSC**—National Television System Committee.  
**CVBS**—labeled “V,” provides a small step up in quality from the Tuner (RF) input. Called Composite Video.  
**S-Video (Y/C)**—provides better picture quality than CVBS. Separates the signal into color and brightness.  
**YPbPr**—provides the best quality video signal. Called Component Video Input, the signal is split into three parts, two color and one brightness.

**10 SIDE JACK PANEL**  
**Signals accepted:** NTSC (480i).  
**Inputs available:** S-Video (Y/C) and CVBS, plus audio left and right.  
**Output available:** Headphone.  
 Only one of the inputs can be used at a time. Select the Side source, and the TV detects the input to which you have connected. Connections must be made to the audio inputs for sound.





## Positioning the TV

Before connecting accessory devices—VCR, DVD player, or HD satellite receiver, for example—please keep the following in mind:

- Place the TV on a flat surface. An unlevel surface may adversely affect picture performance.
- Do not place the TV on shag carpet or any surface that will block the ventilation openings at the bottom of the set. Blockage will cause the TV to overheat and shut down.
- Allow 4 to 6 inches of space behind the TV for ventilation.
- An optional swivel and an optional stand are available for use with your TV. See your electronics dealer.
- Test various locations in the room to find the optimal spot to locate the set for best viewing.
- Do not place the TV in direct sunlight or near a heating appliance.
- Do not expose the TV to rain or moisture.
- To prevent any unsafe situations, do not place objects on top of the TV.

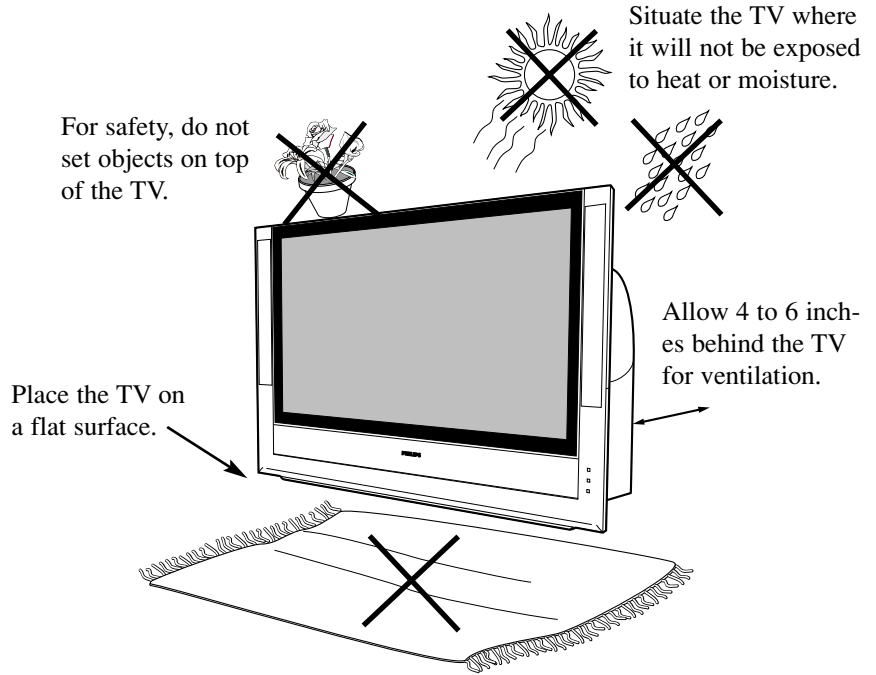

Do not place the TV on a surface that will block the air filters located underneath the set.

## Providing Protection Against Power Surges

- Connect all accessory devices before you plug any of their power cords into the wall outlet or power strip. NEVER plug your TV into an outlet that is controlled by a wall switch.
- Turn off the TV and/or accessory devices before you connect or disconnect any cables.
- Ensure that all antennas and cables are properly grounded. See page 3, “Important Safety Instructions.”

## Protecting Accessory Devices from Overheating

- Arrange accessory devices so that air can circulate freely around them.
- Don't stack the accessory devices. Arrange them to allow for good ventilation. The optional Philips stand provides enough room for two accessory devices, side by side.
- If you connect an audio receiver or amplifier, place it on the top shelf so the heated air from it will not flow around other components.

## Connecting Cables

Be sure to insert each cable firmly into the correct jack.

## Using the Connection Examples in This Manual

The accessory device jack panels shown are for example purpose only. The jack panels on your accessory devices may look different. Also, note that connections can be made in various ways. The examples are presented only as guides.

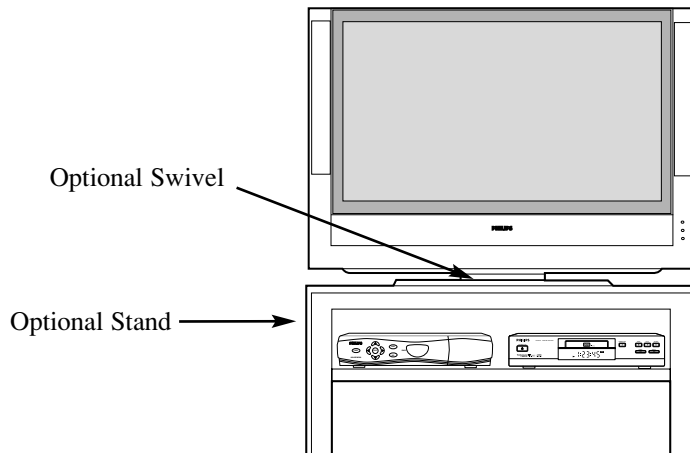



# Connecting a VCR

- 1** Connect the incoming antenna or cable TV signal to the ANT IN jack on the back of the VCR.
- 2** Using a coaxial cable, connect to the OUT jack on the back of the VCR and to the TUNER jack on the back of the TV.
- 3** Using A/V cables, connect from the AUDIO and VIDEO OUT jacks on the back of the VCR to the corresponding AV2 audio (L and R) and video (V) jacks on the back of the TV.
- 4** Press the AV+ button on the remote control to access the Source list.
- 5** Press the Cursor Up or Down button to select the AV2 input source.
- 6** Press the OK button to confirm your choice. The set is now switched to the AV2 input source for the viewing of programs from the VCR.

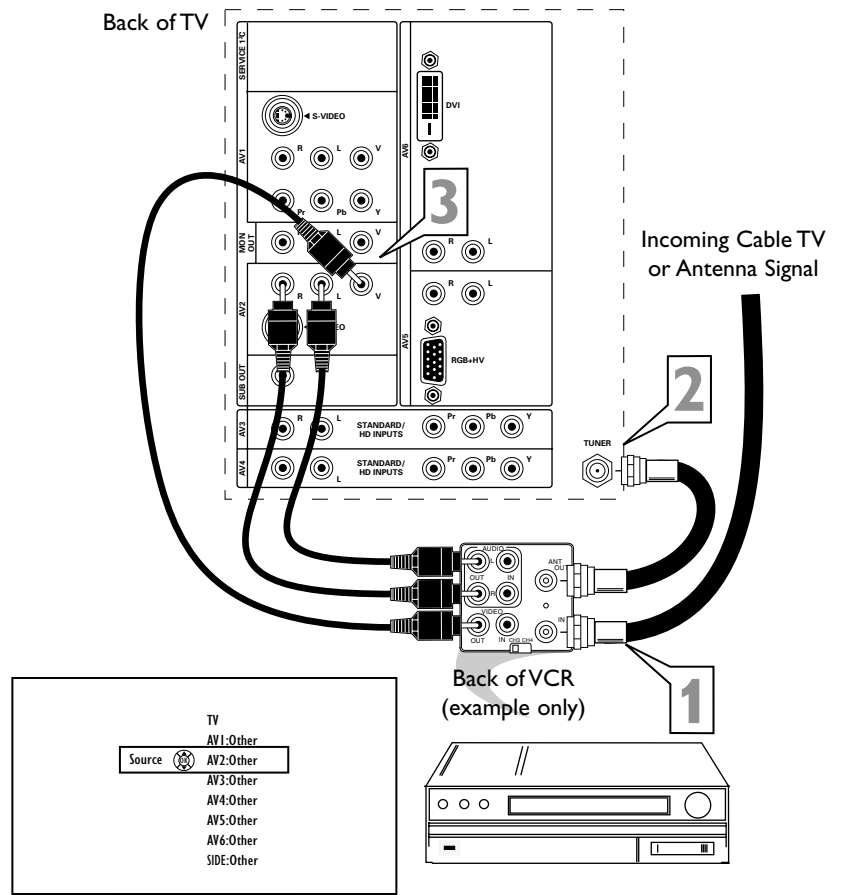

**NOTE:** Since you've connected the cable TV signal directly to the TV's tuner (step 2 above), you can watch the unscrambled programs by simply tuning to the desired channel. To store channels in the TV's memory, you must use Autoprogram, which you can access through "Install" in the TV's on-screen menu. See the Autoprogram section in the *Quick Use and Setup Guide* that came with the TV. If you use Autoprogram, you can select channels by pressing the CH + or - buttons on the TV remote control (in TV mode). Otherwise, you must press the digit (number) buttons to tune directly to the channel you desire.

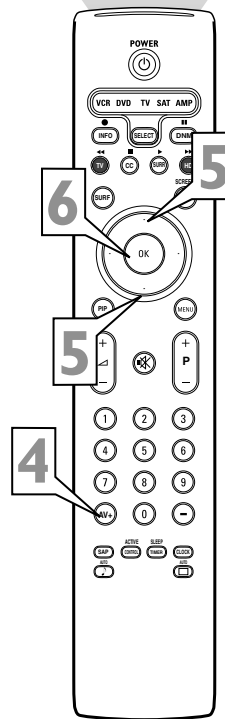

## HELPFUL HINT

**Color Coding Used on Jacks and Plugs to simplify connections:**

**Yellow:** Video (Composite Video)

**Red:** Right Audio

**White:** Left Audio.

# Connecting a VCR and Cable Box



**NOTE:** A cable box with AUDIO OUT jacks such as the one used in the example on this page might pass stereo sound to the TV. Check with your cable TV company. The RF jack output jack on a cable box (commonly labeled “OUT TO TV,” “OUTPUT,” or “OUT”) will not pass stereo sound to your TV.

- 1** Connect the incoming cable TV signal to a two-way signal splitter. The signal splitter enables you to route the cable signal to the TV without using the OUT TO TV jack on the cable box, which will not pass stereo sound to the TV.
- 2** Using a coaxial cable, connect to one of the connectors on the signal splitter and to the TUNER jack on the back of the TV.
- 3** Using a coaxial cable, connect to the other connector on the signal splitter and to the CABLE IN jack on the back of the cable box.
- 4** Using Audio/Video cables, connect to the AUDIO and VIDEO OUT jacks on the back of the cable box and to the corresponding AUDIO and VIDEO IN jacks on the back of the VCR.
- 5** Using Audio/Video cables, connect to the AUDIO and VIDEO OUT jacks on the back of the VCR and to the corresponding AV2 audio (L and R) and video (V) input jacks on the back of the TV.
- 6** Press the AV+ button on the remote control to access the Source list.
- 7** Press the Cursor Up or Down button to select the AV2 input source.
- 8** Press the OK button to confirm your choice. The set is now switched to the AV2 input source for the viewing of programs from the cable box or the VCR.

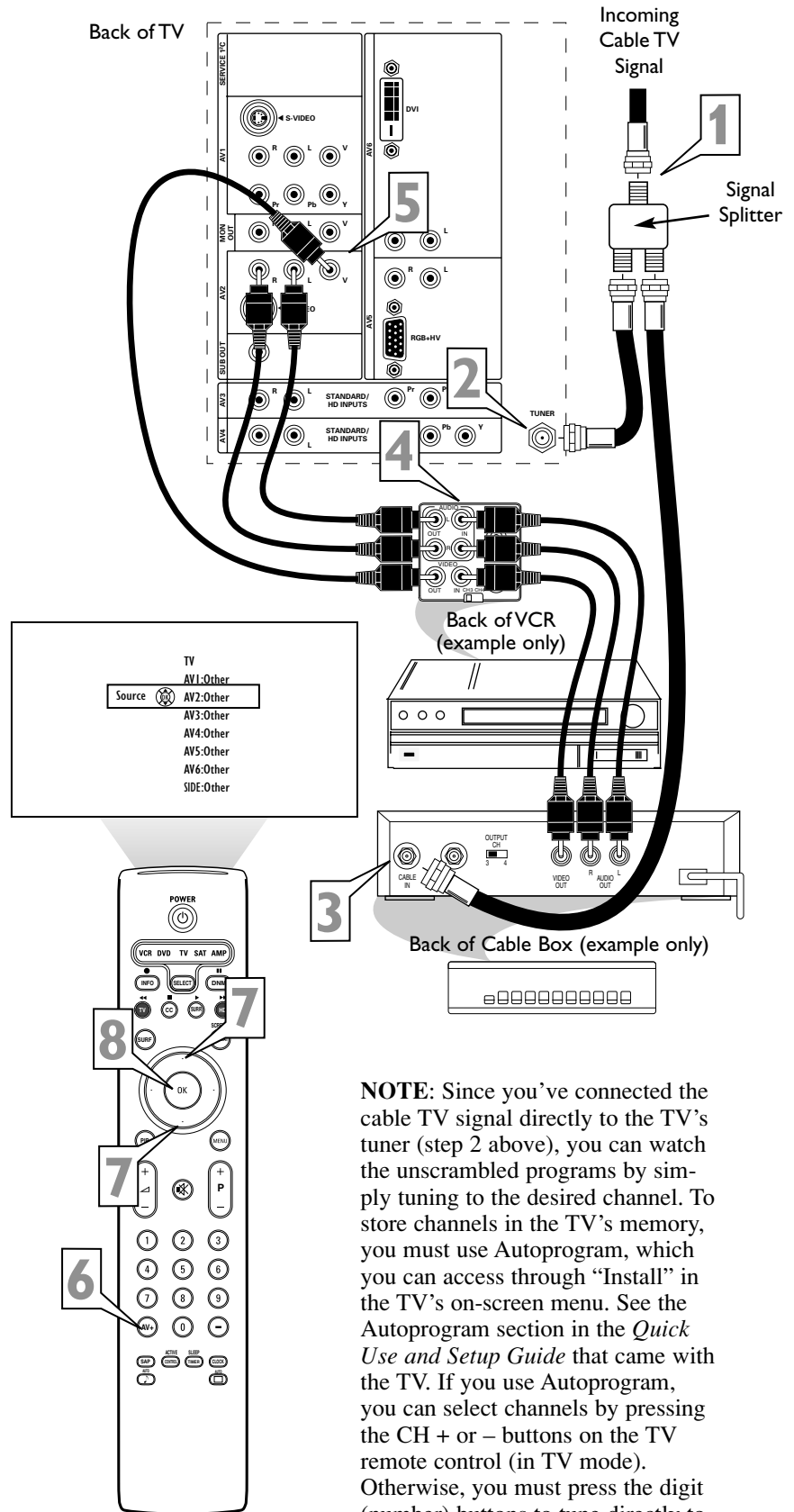

**NOTE:** Since you've connected the cable TV signal directly to the TV's tuner (step 2 above), you can watch the unscrambled programs by simply tuning to the desired channel. To store channels in the TV's memory, you must use Autoprogram, which you can access through "Install" in the TV's on-screen menu. See the Autoprogram section in the *Quick Use and Setup Guide* that came with the TV. If you use Autoprogram, you can select channels by pressing the CH + or – buttons on the TV remote control (in TV mode). Otherwise, you must press the digit (number) buttons to tune directly to the channel you desire.

## HELPFUL HINT

**Color Coding Used on Jacks and Plugs to simplify connections:**  
**Yellow:** Video (Composite Video)  
**Red:** Right Audio  
**White:** Left Audio.



# Connecting an S-Video Device

- 1 Using an S-Video cable, connect to the S-Video output on the back of the S-Video device and to the AV2 S-VIDEO input.
- 2 Using Stereo Audio cables, connect to the AUDIO OUT jacks on the back of the S-Video device and to the corresponding AV2 audio inputs (L and R).
- 3 Press the AV+ button on the remote control to access the Source list.
- 4 Press the Cursor Up or Down button to select the AV2 input source.
- 5 Press the OK button to confirm your choice. The set is now switched to the AV2 input source for the viewing of programs from the S-Video device.

## HELPFUL HINT

To simplify making connections, the connectors on audio and video cables are often color coded to match the colors on TV jacks, red for right, and white for left.

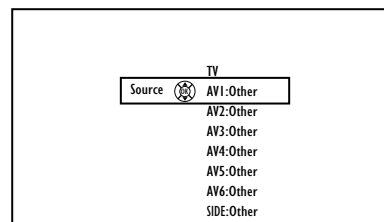
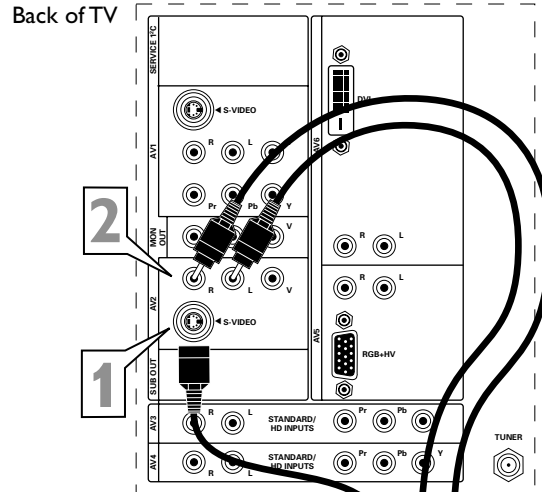

Back of Standard S-Video Device (example only)

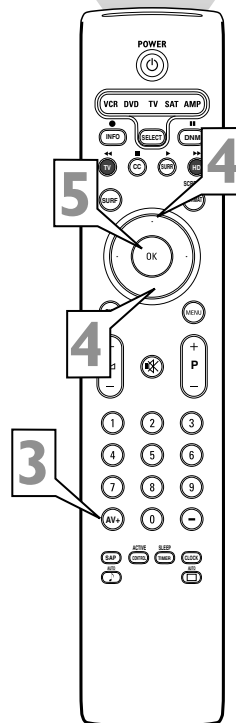
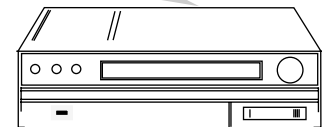

# Connecting a Standard DVD Player



- 1** Using Audio/Video cables, connect to the YPbPr jacks on the back of the standard DVD player and to the AV1 YPbPr jacks on the back of the TV.
- 2** Using Stereo Audio cables, connect to the AUDIO OUT jacks on the back of the DVD player and to the corresponding AV1 audio (L and R) jacks on the back of the TV.
- 3** Press the AV+ button on the remote control to access the Source list.
- 4** Press the Cursor Up or Down button to select the AV1 input source.
- 5** Press the OK button to confirm your choice. The set is now switched to the AV1 input source for the viewing of programs from the DVD player.

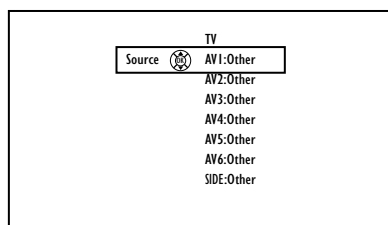
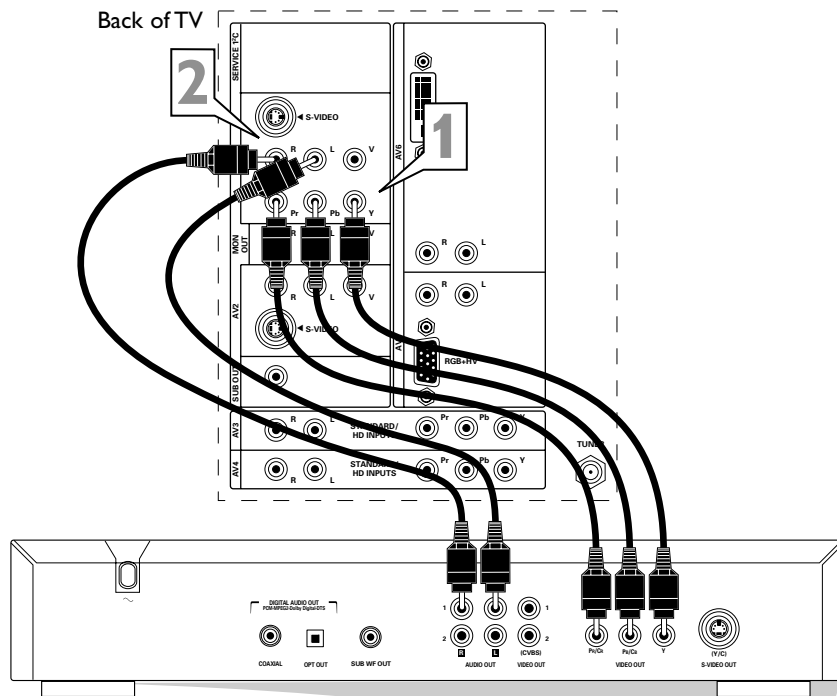

Back of Standard DVD Player (example only)

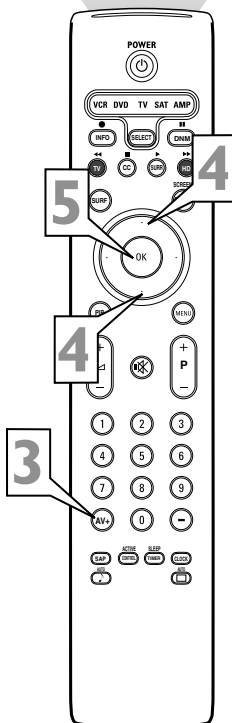

## HELPFUL HINTS

- If you do not know whether your DVD player is standard or progressive scan, you can connect it to either AV3 or AV4, and the TV will automatically determine the type of output.
- To simplify making connections, the connectors on audio and video cables are often color coded to match the colors on TV jacks: green for Y, blue for Pb, and red for Pr; also red for right audio, and white for left audio.
- The names for the component video jacks may differ depending on the DVD player or accessory digital source equipment used. For example, besides YPbPr, you may see R-Y/B-Y/Y; or CrCbY. Although abbreviations and terms may vary, the letters *B* and *R* stand for the blue and red color component signal connectors, respectively, and *Y* indicates the luminance signal. If necessary, refer to the user manual for your DVD or digital accessory for more information.
- If you experience difficulties receiving sound with a DVD disc, check the sound settings through the DVD disc's menu.



# Connecting a Progressive-scan DVD Player

**1** Using Audio/Video cables, connect to the YPbPr jacks on the back of the progressive-scan DVD player and to the AV3 or AV4 YPbPr jacks on the back of the TV.

**2** Using Stereo Audio cables, connect to the AUDIO OUT jacks on the back of the DVD player and to the corresponding AV3 or AV4 audio (L and R) jacks on the back of the TV.

**3** If your DVD player has an I/P switch on the back, be sure it is set to the “P” position for progressive-scan mode.  
**NOTE:** Some DVD players have an I/P switch on the back, while others may allow the user to change the mode by pressing a button on the DVD player’s remote control or by using the DVD player’s on-screen menu. Also, some DVD players have dedicated progressive-scan output jacks that are labeled as such and require no switching by the user. See the user manual for your DVD player for more information on placing the player in progressive-scan mode.

**4** Press the AV+ button on the remote control to access the Source list.

**5** Press the Cursor Up or Down button to select the AV3 input source.

**6** Press the OK button to confirm your choice. The set is now switched to the AV3 input source for the viewing of programs from the DVD player.

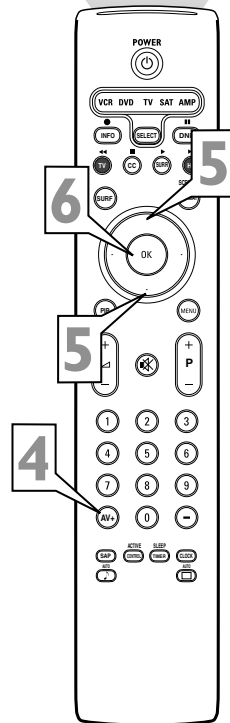
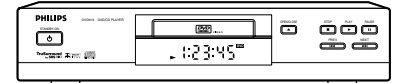
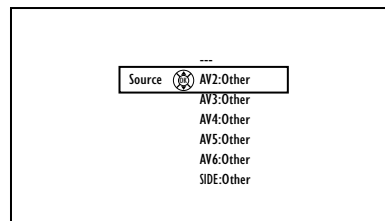
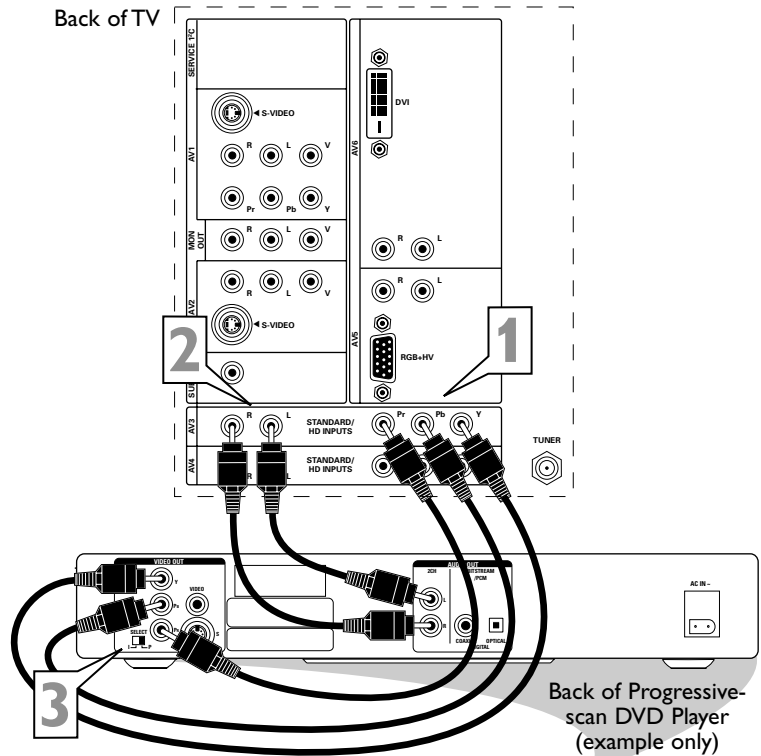

## HELPFUL HINTS

**HELPFUL HINT**  
Inputs AV3–AV6 allow horizontal and vertical picture panning using the Cursor Left, Right, Up, and Down buttons. The Side input allows vertical picture panning; left and right panning with the Side input is possible when the input has been labeled “Game.” See pages 18 and 19 for details on side panel connections and source labeling.

- To simplify making connections, the connectors on audio and video cables are often color coded to match the colors on TV jacks: green for Y, blue for Pb, and red for Pr; also red for right audio, and white for left audio.
- The names for the component video jacks may differ depending on the DVD player or accessory digital source equipment used. For example, besides YPbPr, you may see R-Y/B-Y/Y; or CrCbY. Although abbreviations and terms may vary, the letters *B* and *R* stand for the blue and red color component signal connectors, respectively, and *Y* indicates the luminance signal. If necessary, refer to the user manual for your DVD or digital accessory for more information.
- If you experience difficulties receiving sound with a DVD disc, check the sound settings through the DVD disc’s menu.

# Connecting an HD Satellite Receiver to YPbPr



- 1** Using Component Video cables, connect to the YPbPr jacks on the back of the HD satellite receiver and to the corresponding AV3 or AV4 YPbPr jacks on the back of the TV.
- 2** Using Stereo Audio cables, connect to the AUDIO OUT jacks on the back of the HD satellite receiver and to the corresponding AV3 or AV4 audio (L and R) jacks on the back of the TV.
- 3** Refer to the user manual for the HD satellite receiver to complete the connections to the HD satellite receiver and to use the HD satellite receiver's on-screen setup menus.
- 4** After completing HD satellite receiver connections and setup through the on-screen setup menus, press the AV+ button on the TV remote to access the Source list.
- 5** Press the Cursor Up or Down button to select the AV4 input source.
- 6** Press the OK button to confirm your choice. The set is now switched to the AV4 input source for the viewing of programs from the HD satellite receiver.

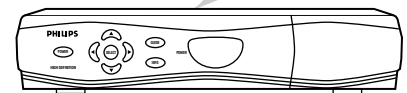
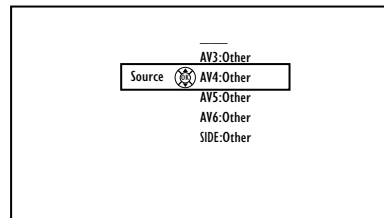
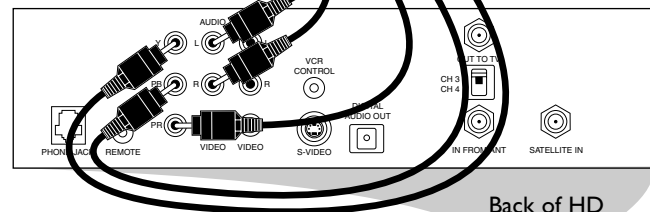
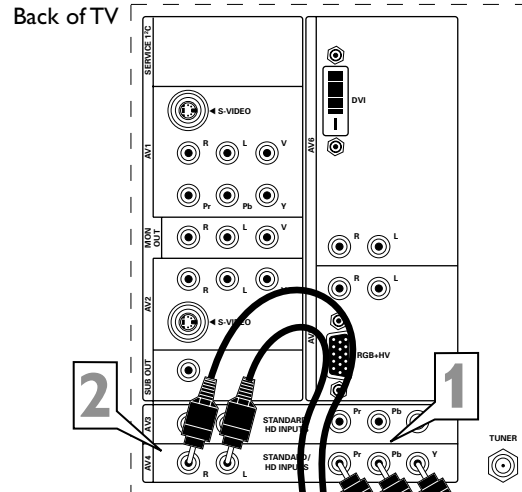

## HELPFUL HINTS

- To simplify making connections, the connectors on audio and video cables are often color coded to match the colors on TV jacks: green for Y, blue for Pb, and red for Pr; also red for right audio, and white for left audio.
- The names for the component video jacks may differ depending on the DVD player or accessory digital source equipment used. For example, besides YPbPr, you may see R-Y/B-Y/Y; or CrCbY. Although abbreviations and terms may vary, the letters *B* and *R* stand for the blue and red color component signal connectors, respectively, and *Y* indicates the luminance signal. If necessary, refer to the user manual for your DVD or digital accessory for more information.
- Inputs AV3–AV6 allow horizontal and vertical picture panning using the Cursor Left, Right, Up, and Down buttons. The Side input allows vertical picture panning; left and right panning with the Side input is possible when the input has been labeled “Game.” See pages 18 and 19 for details on side panel connections and source labeling.

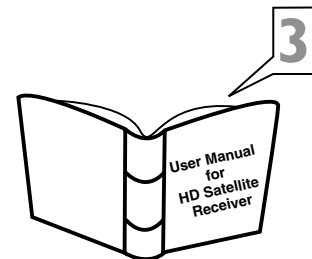
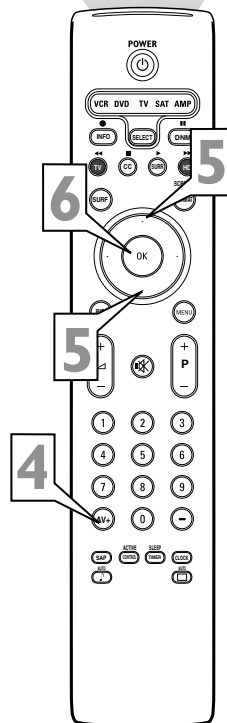



# Connecting an HD Satellite Receiver to DVI

- 1** Using a DVI cable, connect to the DVI jack on the back of the HD satellite receiver and to the corresponding AV6 DVI jack on the back of the TV.
- 2** Using Stereo Audio cables, connect to the AUDIO OUT jacks on the back of the HD satellite receiver and to the corresponding AV6 audio (L and R) jacks on the back of the TV.
- 3** Refer to the user manual for the HD satellite receiver to complete the connections to the HD satellite receiver and to use the HD satellite receiver's on-screen setup menus.
- 4** After completing HD satellite receiver connections and setup through the on-screen setup menus, press the AV+ button on the TV remote to access the Source list.
- 5** Press the Cursor Up or Down button to select the AV6 input source.
- 6** Press the OK button to confirm your choice. The set is now switched to the AV6 input source for the viewing of programs from the HD satellite receiver.

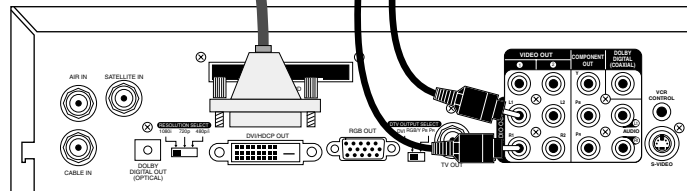
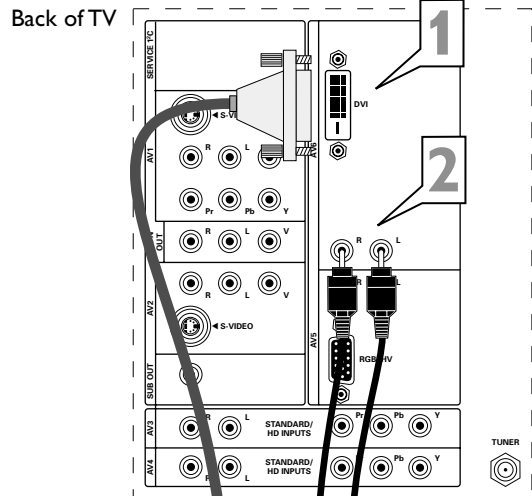

Back of HD Satellite Receiver (example only)

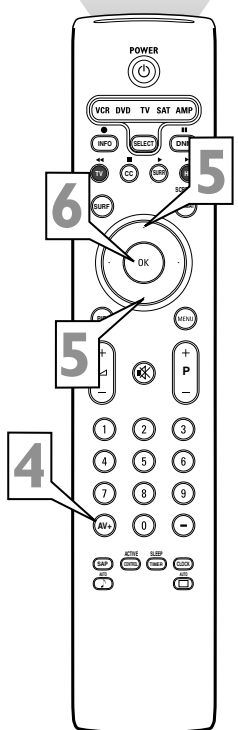
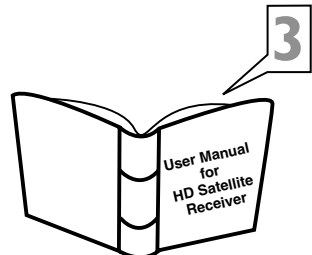
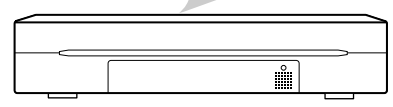
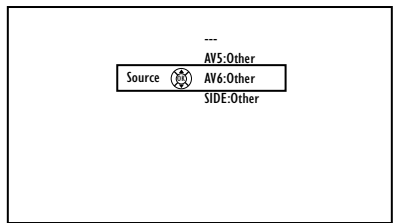

## HELPFUL HINTS

- To simplify making connections, the connectors on audio cables are often color coded to match the colors on TV jacks: red for right audio, and white for left audio.
- Because DVI is such new technology, the electronics industry is still working toward a decision on one standard. Philips testing has determined that compatibility issues exist with respect to a limited number of high-definition receivers when they are connected to the DVI input on this television. If you should experience difficulties, please contact our Customer Care Center at 1-800-531-0039.
- Inputs AV3–AV6 allow horizontal and vertical picture panning using the Cursor Left, Right, Up, and Down buttons. The Side input allows vertical picture panning; left and right panning with the Side input is possible when the input has been labeled “Game.” See pages 18 and 19 for details on side panel connections and source labeling.



# Connecting Surround Sound Equipment



- 1** Using Stereo Audio cables, connect to the MON OUT L and R jacks on the back of the TV and to the corresponding TV IN jacks on the back of the receiver.
- 2** Using an Audio cable, connect to the SUB OUT jack on the back of the TV and to the Audio Input jack on the back of a powered subwoofer.
- 3** Using speaker wires, connect to the R and L Front Speakers terminals and to the corresponding terminals on the backs of the front speakers.
- 4** Using speaker wires, connect to the Surround Speakers terminals (+, -) on the back of the receiver and to the corresponding terminals (+, -) on the back of the surround speakers.
- 5** Press the Menu button on the remote control to display the on-screen menu.
- 6** Press the Cursor Down button to select "Settings."
- 7** Press the Cursor Right button to select "General."
- 8** Press the Cursor Down button repeatedly until "Subwoofer" is selected.
- 9** Press the Cursor Right or Left button to select "Yes."

**NOTE:** "Yes" must be activated for the Subwoofer menu selection before the SUB OUT jack will supply output. This is because the subwoofer's low frequencies are redirected to the main TV speakers when "No" is selected.

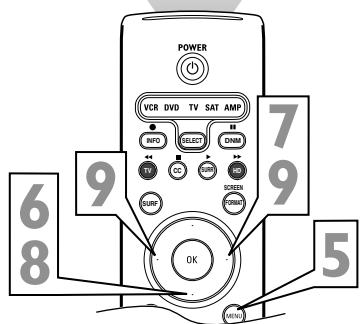
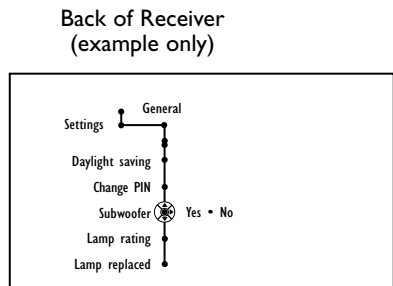
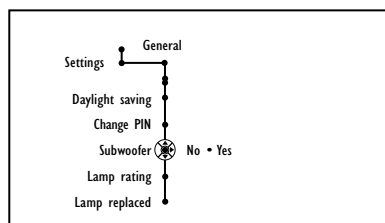
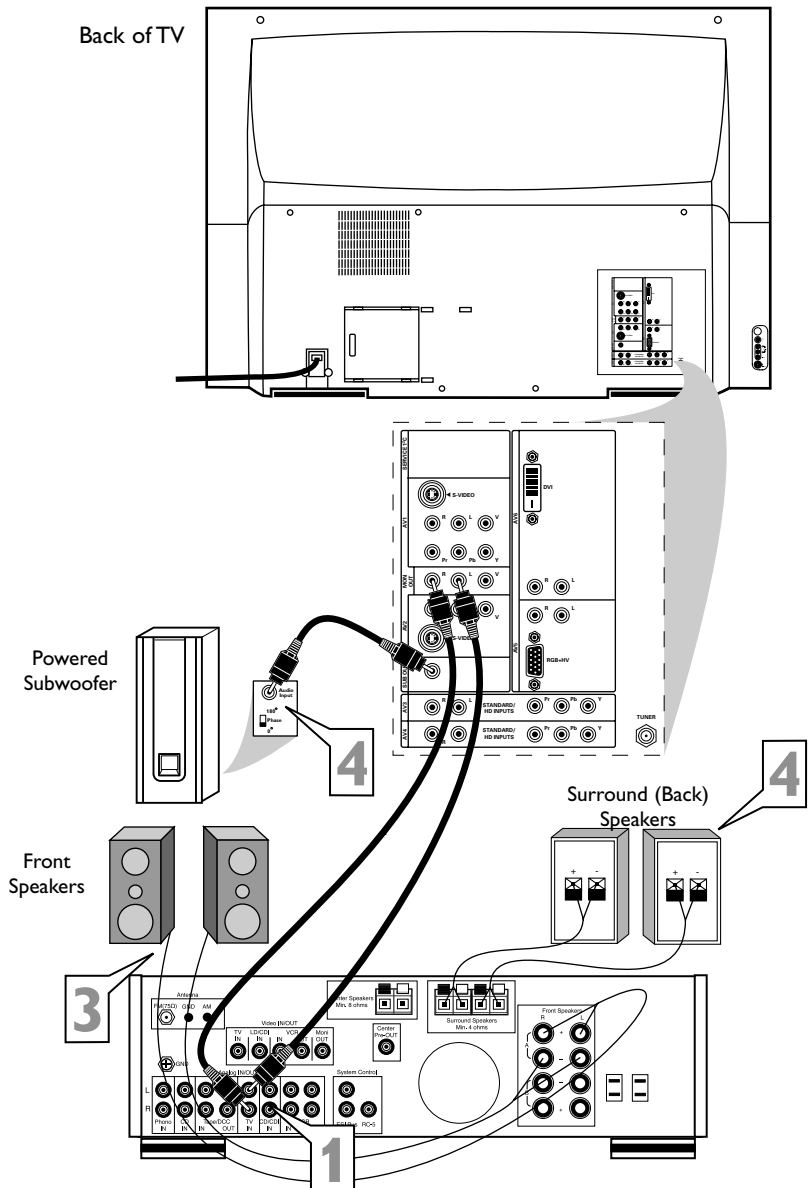

**HELPFUL HINT**

To simplify making connections, the connectors on audio cables are often color coded to match the colors on TV jacks: red for right audio, and white for left audio.



# Connecting to the Side Inputs: Video Game System

**1** Using the Audio/Video cable supplied with your video game system, connect to the back of the game system and to the corresponding S-VIDEO and AUDIO (L and R) jacks in the Side panel of the TV.

**NOTE:** If your game system cable does not have an S-Video plug, you can instead make a regular Video connection.

**2** Press the Source button on the TV remote control to access the Source list.

**3** Press the Cursor Up or Down button to select the Side input source.

**4** Press the OK button to confirm your choice. The set is now switched to the Side input source for the viewing of your video game system.

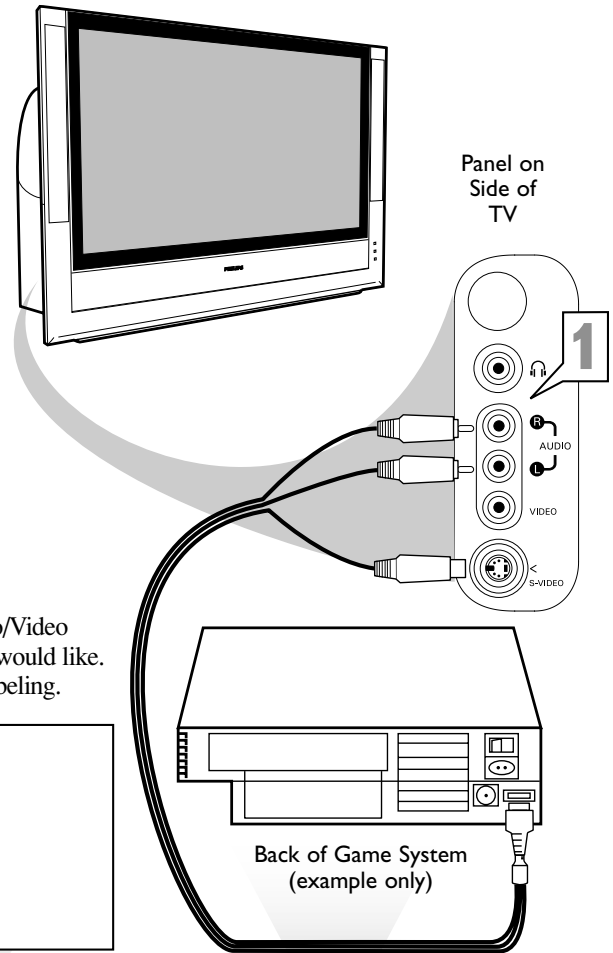

You can label the Side Audio/Video input source "Game" if you would like. See page 19 for details on labeling.

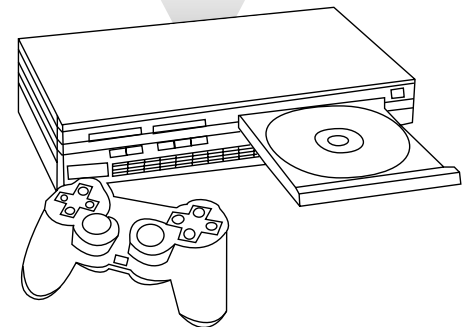
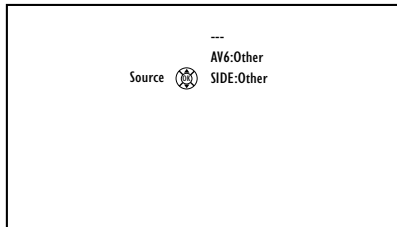

**HELPFUL HINTS**

- To simplify making connections, the connectors on audio and video cables are often color coded to match the colors on TV jacks: yellow for video (composite), red for right audio, and white for left audio.
- Inputs AV3–AV6 allow horizontal and vertical picture panning using the Cursor Left, Right, Up, and Down buttons. The Side input allows vertical picture panning; left and right panning with the Side input is possible when the input has been labeled "Game." See page 19 for details on source labeling.

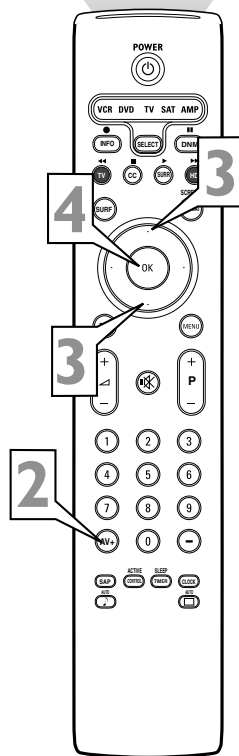

The side panel is also convenient for connecting equipment such as camcorders or cameras. If the equipment has an S-Video output jack, it is the suggested one to use for your connection to receive the best picture. Otherwise, you can make a regular Video connection. You must also make an audio connection (L and R for stereo or L for mono) to receive sound. Neither an S-Video or Video cable carries a sound signal.

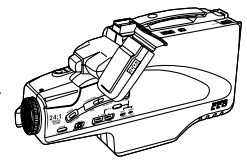

Camcorder

# Labeling the Audio/Video Input Sources



You can label all the external Audio/Video input sources—AV1, AV2, AV3, AV4, AV5, AV6, and Side—according to the type of accessory device you have connected to each input.

After labeling, you can use the Source button to cycle through and select your desired source. The labels will appear alongside the channel indicator when you select the AV input sources.

- 1** Press the Menu button on the remote control to display the on-screen menu.
- 2** Press the Cursor Down button to select “Settings.”
- 3** Press the Cursor Right button repeatedly to select the “Source” menu.
- 4** Press the Cursor Down button repeatedly to select any of the AV Inputs—AV1, AV2, AV3, AV4, AV5, AV6, or Side. A list of labels will appear next to the selected AV input.
- 5** Press the Cursor Right button to enter the list.
- 6** Press the Cursor Up or Down button to scroll and select one of the labels in the list.
- 7** Press the Menu button on the remote control to remove the on-screen menu from the TV screen.
- 8** Press the Source button on the remote control to display the list of AV inputs and their labels.

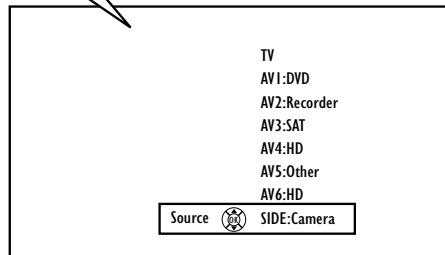
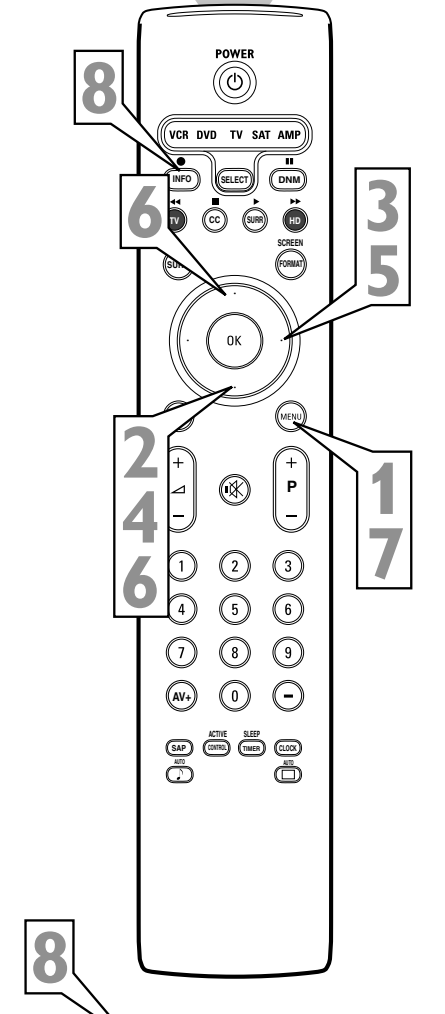
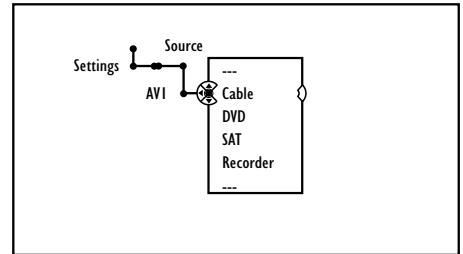
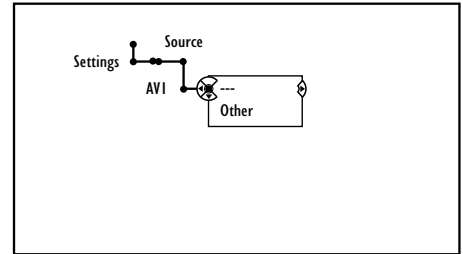
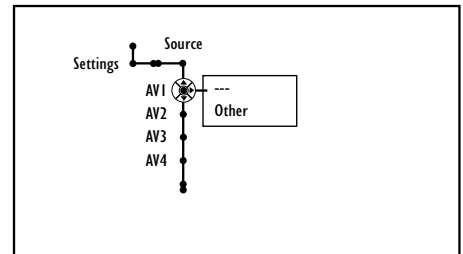
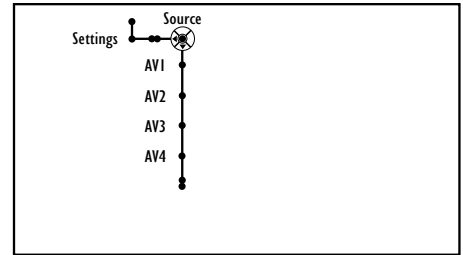
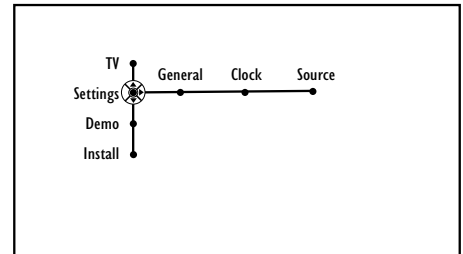
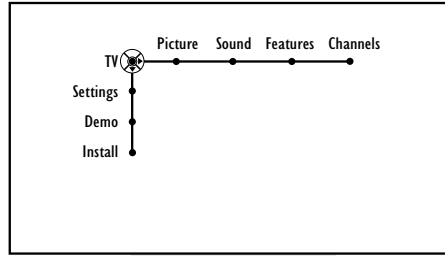

This is just a sample of what the labeling might look like. Your Source Labels will depend on the options you choose to label the AV inputs.



# Remote Control Buttons

## Select (CBL VCR DVD SAT AMP) and Backlight

Press this button to cycle across the accessory mode dial. Stop pressing when the mode you desire is lighted. The light will stay on for 2 seconds and then begin blinking to indicate the remote is in your desired mode. As long as the button blinks, the remote is in the accessory mode. (See pages 22–25 for programming the remote) Pressing and holding the Select button for 2 seconds backlights the remote control buttons. The buttons remain lighted for 5 seconds after you press Select.

## Information Plus

Press to show information (when available) about the current channel, program, source, number or name, local time, CC availability, SAP availability, program ratings, display format, sound mode, and remaining length of a Sleptimer setting.

## TV

Press to directly set the TV into the TV Mode of operation.

## CC (Closed Captioning)

Press to turn Closed Captioning off, on, or on during mute. (See page 47 in the *Directions for Use* manual.)

## Surf

If you set the Surf control in the TV's on-screen menu to two channels, this button will allow you to toggle between the current channel and the last viewed channel. If you choose the nine-channel Surf, pressing this button allows you to add and scroll up to nine of your favorite channels. See page 57 in the *Directions for Use* manual.

## OK

Press to activate or confirm menu choices.

## Dual Screen/PIP (Picture-in-Picture)

Press to turn the PIP dual screen on or off. Continuing to hold the Dual Screen/PIP button down will cycle through the Dual Screen/PIP options. (See page 58 in the *Directions for Use* manual.)

## VOL (Volume)

Press + or – to adjust the volume.

## Mute

Press to interrupt or restore sound.

## Source (AV+)

Press to display a list of source options—TV, AV1, AV2, AV3, AV4, AV5, AV6, or Side. Use the Cursor Up/Down buttons to select the next item, then press the OK button to confirm or press the Source Select button to select the next item in the list.

## Alternate Audio (SAP)

When you tune to a channel where SAP (Second Audio Program) is available, you can toggle between Main and SAP. If SAP is not available, only Main can be selected. (See page 42 in the *Directions for Use* manual.)

## AutoSound™

Press to select the next item in the AutoSound™ menu. The factory-set options are Speech, Music, Movies, and Multimedia, each corresponding with specific settings of treble and bass. You can also select the Personal option, which is based on the adjustments you make through the Sound menu. (See page 46 in the *Directions for Use*.)

## Active Control™ Plus

**NOTE:** Active Control™ Plus is not available for use with the AV3, AV4, AV5, and AV6 input sources.

Press to toggle the options Off, Minimum, Medium, and Maximum. Maximum is the recommended option. (See page 28 in the *Directions for Use* manual.)

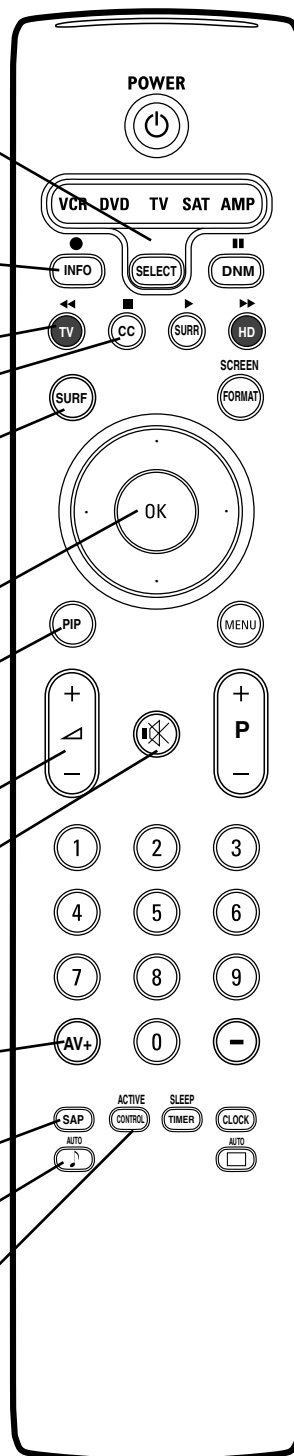

Active Control, AutoSurf, Incredible Surround, are trademarks of Philips Consumer Electronics. Copyright 2004 Philips Consumer Electronics. All rights reserved.

\*Manufactured under license from Dolby Laboratories. "Dolby" and the double-D symbol are trademarks of Dolby Laboratories.

# Remote Control Buttons



**Standby-On (Power)**  
Press to turn the TV on or off.  
**NOTE:** The TV is never powered off completely unless it is physically unplugged from the power source.

**DNM**  
Press to turn the Digital Natural Motion function on or off.

**VCR/DVD Mode**  
When in the remote control is in the VCR (DVD) mode of operation, these buttons will allow you record, rewind, stop playback, play, or fast-forward playback.

**Surround Sound**  
Press to display a list of available sound modes. Choose from Incredible Surround™ and Dolby\* Virtual settings. (See page 41 in the *Directions for Use* manual)

**HD**  
Press to activate the AV6 (High Definition) jacks and place the TV into the High Definition Mode of operation.

**Screen Format**  
Press to display a list of available picture formats for showing video images in the traditional 4:3 proportions. Press this button repeatedly to select a picture format. Choose from Automatic, Super zoom, Panoramic, 4:3, Movie expand 14:9, Movie expand 16:9, 16:9 subtitle, and Wide screen. See pages 35–36 in the *Directions for Use* manual.  
**NOTES:**

- With AV3–AV6 connections, the Automatic picture format option is not available.
- In Dual Screen mode, press the Picture Format button to switch between a full or 4:3 letterbox picture format.

**Cursor Up, Down, Right, Left**  
Use to navigate the on-screen menu and make control adjustments or settings.  
Additionally, use these buttons to pan the screen up or down to show any excluded parts of the picture.

**Menu On/Off**  
Press to display the TV's on-screen menu or to turn it off.

**CH (Channel Selection)**  
Press to browse through the TV channels.

**Digit (Number Buttons)**  
Press to directly access a specific TV channel. For a two- or three-digit channel, enter all numbers. Press a single-digit button and hold a bit longer to directly access a single-digit channel. These buttons can also be used to enter values in certain on-screen menu controls.

**Clock (Time Display)**  
Press to display the current time on the TV screen. (See page 65 in the *Directions for Use* manual to set the clock)

**AutoPicture™**  
Press to select the next item in the AutoPicture™ menu. The factory-set options are Rich, Natural, Soft, Multimedia, and Eco, each corresponding with specific factory settings of Contrast, Color, Sharpness, DNR, Dynamic Contrast, and Color enhancements. You can also select the Personal option, which is based on the adjustments or settings you make through the Picture menu. (See page 34 in the *Directions for Use*.)

**Sleeptimer**  
Press to set the sleeptimer feature to turn the TV off automatically. You can choose—5 minutes up to 180 minutes in 5-minute increments.



# Programming the Remote Control

Your TV remote control can operate accessory devices such as cable boxes, VCRs, DVD players, satellite receivers, and amplifiers.

Normally, the remote is in TV mode. You must press the Select button to switch the remote to one of the accessory modes—CBL, VCR, DVD, SAT, or AMP.

It is likely you will need to program your remote, but, before you do, try this test:

- Press the Select button repeatedly until the mode you desire lights up. When the light begins blinking, point the remote toward the accessory device, then press the Standby-On button. If the device responds you do not need to program the remote. If not, follow the steps below to program the remote.

**1** Look up the number for the device on the list below:

- 1 Cable (CBL)
- 2 VCR
- 3 DVD
- 4 Satellite (SAT)
- 5 Amplifier (AMP)

Look up the number for the manufacturer on pages 24–25.

**2** Press the Select and Standby-On buttons at the same time, then release.

**3** Press the number for the device followed by the manufacturer's code. The green Standby-On light will blink, indicating the code is valid. If the light does not blink, start again at step 1 using another code (if available).

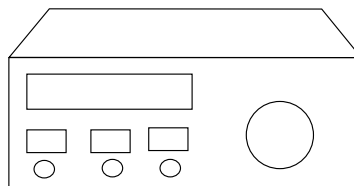

AMP

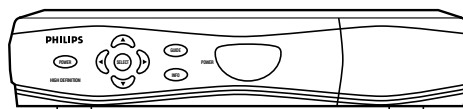

SAT

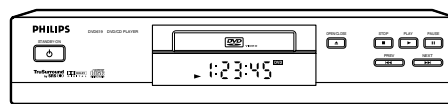

DVD

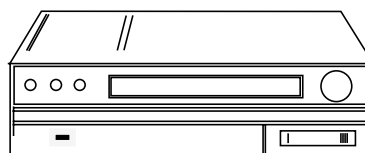

VCR

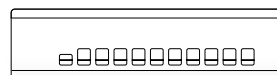

CBL

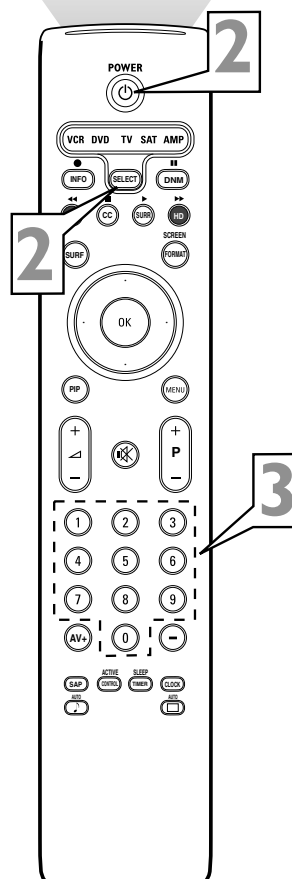

# Programming the Remote Control



Now try to use the remote control with the accessory device to see if it is correctly programmed.

- 4** Press the Select button on the remote to select the type of device. When the mode you desire lights up, stop pressing the button. When the light begins blinking the remote is ready for use with the device.
- 5** Press the Standby–On button. As long as the light keeps blinking, you can use the remote with the selected device. Once the light disappears, the remote is back in TV mode.

If the device does not respond to the Standby–On command, repeat steps 1–6 using a different code. If there are no other for the type and brand of accessory device, the remote likely will not operate your particular model of accessory device.

**NOTE:** Your TV remote is not necessarily capable of operating all models of the brands of accessory devices listed on pages 24–25. You may want to try the programming process again. Try using the number(s) that are listed for your type and brand of device to be sure you did not make a mistake in inputting the digits during your first attempt at programming.

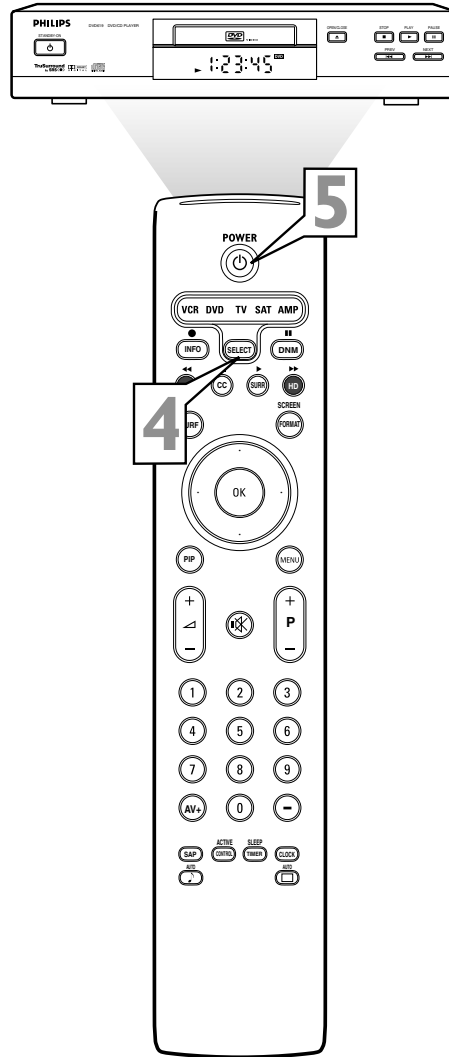

## CHECK IT OUT

You can change the duration of the time-out mode by simultaneously pressing the Select button and a digit button, 1–4. Using digit 1 will set the time-out to 15 seconds; digit 2, 30 seconds; digit 3, 60 seconds; and digit 4, 120 seconds. The default time-out setting after you replace the batteries in the remote is 60 seconds. All modes will have the same time-out setting.

## HELPFUL HINT

If the remote control is in one of the accessory modes (a mode light is flashing)—CBL, VCR, DVD, SAT, AMP—and you don't press any of the remote buttons for sixty seconds, a "time-out" occurs, returning the remote to TV mode.



# Programming the Remote Control: Setup Codes

## Amplifier

Carver	.0296
Curtis Mathes	.0327
GE	.0105
JVC	.0358
Linn	.0296
Magnavox	.0296
Marantz	.0296
Optimus	.0422, 0327
Philips	.0296
Pioneer	.0327
Polk Audio	.0296
RCA	.0327
Realistic	.0422
Sony	.0716, 0247
Soundesign	.0105
Victor	.0358
Wards	.0105
Yamaha	.0381

## Cable Box

ABC	.0030, 0034, 0035
Allegro	.0180, 0342
Americast	.0926
Archer	.0180, 0824
BellSouth	.0926
Century	.0180
Citizen	.0180, 0342
Comtronics	.0067
Contec	.0046
Emerson	.0824
Everquest	.0042, 0067
Focus	.0427
Garrard	.0180
Gemini	.0042
General Instrument	.0503, 0837
GoldStar	.0067, 0171
Goodmind	.0824
Hamlin	.0047, 0036, 0286, 0061
Hytex	.0034
Jasco	.0042, 0180, 0342
Jerrold	.0030, 0039, 0503, 0042, .0837
Memorex	.0027
Motorola	.1133
Movie Time	.0090
NSC	.0090
Oak	.0046, 0034
Optimus	.0048
Panasonic	.0048, 0134, 0027
Paragon	.0027
Philips	.0180, 0332, 0344
Pioneer	.0171, 0560, 0904
Popular Mechanics	.0427
Pulsar	.0027
Quasar	.0027
RCA	.0048
Radio Shack	.0042, 0910, 0342, 0824
Recoton	.0427
Regal	.0047, 0286
Runco	.0027
SL Marx	.0067
Samsung	.0067, 0171
Scientific Atlanta	.0035, 0504, 0904
Signal	.0042, 0067
Sprucer	.0048
Starcom	.0030, 0042
Stargate	.0067, 0042, 0824
Starquest	.0042
TV86	.0090

Televue	.0067
Tocom	.0039
Toshiba	.0027
Tusa	.0042
Unika	.0180
United Artists	.0034
Universal	.0180, 0218
Viewstar	.0090
Zenith	.0027, 0552, 0926
Zentek	.0427

## Surround Sound Receiver

ADC	.0558
Aiwa	.0148
Capetronic	.0558
Carver	.0069, 1116, 1216
Casio	.0222
Clarinet	.0222
Denon	.1187, 1131
Fisher	.0069
Garrard	.0490
Harman/Kardon	.0137
JVC	.0101
Kenwood	.1054, 0069, 0213, 1340 .1596, 1597
Lloyd's	.0222
MCS	.0066
Magnavox	.0418, 1116, 0558, 1216 .0222
Marantz	.1116, 1216, 0066
Modulaire	.0222
Nakamichi	.0124
Onkyo	.0162
Optimus	.1050, 0213, 0558, 0069
Panasonic	.0066, 1545
Penney	.0222
Philips	.1116, 1216, 1296, 0418
Pioneer	.0177, 0558, 1050
Proscan	.1281
Quasar	.0066
RCA	.1281, 0558, 1050
Realistic	.0222
Sansui	.1116
Sharp	.0213
Sherwood	.0529
Sony	.1185, 1085, 1285
Sunfire	.1340
Teac	.0490
Technics	.0066, 1335, 1545, 1336
Thorens	.1216
Victor	.0101
Yamaha	.0203, 0213, 1203
Yorx	.0222

## Satellite Receiver

AlphaStar	.0799
Echostar	.1032, 0802
Expressvu	.0802
GE	.0593
General Instrument	.0388, 0896, 0654
HTS	.0802
Hitachi	.0846
Hughes Network Systems	.0776
JVC	.0802
Jerrold	.0388, 0654
Magnavox	.0749, 0751
Memorex	.0751
Next Level	.0896
Panasonic	.0728
Philips	.1103, 0749, 0751
Primestar	.0654, 0388

RCA	.0593, 0170, 0419, 0882
Radio Shack	.0896
Samsung	.1136
Sony	.0666
Star Choice	.0896
Toshiba	.0776, 0817
Uniden	.0751, 0749
Zenith	.0883

## VCR

Admiral	.0075, 0236
Adventura	.0027
Aiko	.0305
Aiwa	.0027, 0064
Akai	.0068
America Action	.0305
American High	.0062
Asha	.0267
Audiovox	.0064
Beaumarck	.0267
Bell & Howell	.0131
Broksonic	.0148, 0211, 0029, 0236, 0506
CCE	.0099, 0305
Calix	.0064
Canon	.0062
Carver	.0108
Cineral	.0305
Citizen	.0305, 0064
Colt	.0099
Craig	.0064, 0099, 0074, 0267, 0298
Curtis Mathes	.0062, 0068, 0087, 0189 .0787
Cybernex	.0267
Daewoo	.0305, 0072
Denon	.0069
Dynatech	.0027
Electrohome	.0064
Electroponic	.0064
Emerex	.0059
Emerson	.0211, 0029, 0236, 0305, .0148, 0506, 0027, 0064, .0070
Fisher	.0074, 0131
Fuji	.0062
Funai	.0027
GE	.0062, 0087, 0075, 0267, .0787
Garrard	.0027
Go Video	.0459, 0553
GoldStar	.0064, 0065
Gradiente	.0027
HI-Q	.0074
Harley Davidson	.0027
Harman/Kardon	.0065, 0108
Harwood	.0099
Hitachi	.0069, 0027, 0068
Hughes Network Systems	.0069
JVC	.0094, 0068
Jensen	.0068
KEC	.0064, 0305
KLH	.0099
Kenwood	.0068, 0094, 0065
Kodak	.0062, 0064
LXI	.0064
Lloyd's	.0027
Logik	.0099
MEI	.0062
MGA	.0070, 0267
MGN Technology	.0267
MTC	.0027, 0267
Magnasonic	.0305
Magnavox	.0062, 0108, 0027, 0066, 0176



# Programming the Remote Control: Setup Codes



## VCR (continued)

Magnin	.0267	Realistic	.0027, 0131, 0074, 0075, .0064, 0062	XR-1000	.0099, 0027, 0062
Marantz	.0108, 0062	ReplayTV	.0641, 0643	Yamaha	.0065
Marta	.0064	Runco	.0066	Zenith	.0066, 0027, 0236, 0506
Matsushita	.0062, 0189	STS	.0069		
Memorex	.0131, 0074, 0506, 0027	Samsung	.0072, 0267		
	.0064, 0075, 0062, 0267	Sanky	.0066, 0075		
	.0066, 0189, 0236, 1189	Sansui	.0068, 0506, 0027, 0094, 0236, 0298		
Minolta	.0069	Sanyo	.0074, 0131, 0267		
Mitsubishi	.0070, 0075, 0094	Scott	.0211, 0148, 0070, 0072		
Motorola	.0062, 0075	Sears	.0064, 0069, 0027, 0062, .0074, 0131		
Multitech	.0027, 0099	Semp	.0072		
NEC	.0065, 0068, 0094, 0131	Sharp	.0075		
Nikko	.0064	Shintom	.0099		
Noblex	.0267	Shogun	.0267		
Olympus	.0062	Singer	.0099		
Optimus	.0189, 1189, 0075, 0064, .0131, 0459	Sony	.0059, 0027, 0062, 0063		
Orion	.0506, 0029, 0211, 0236	Sylvania	.0062, 0108, 0027, 0070		
Panasonic	.0062, 0189, 1189, 0643	Symphonic	.0027		
Penney	.0062, 0267, 0064, 0069, 0065	TMK	.0267		
Pentax	.0069	Tatung	.0068		
Philco	.0062, 0236, 0506	Teac	.0027, 0068		
Philips	.0108, 0062, 0645	Technics	.0062, 0189		
Pilot	.0064	Teknika	.0027, 0062, 0064		
Pioneer	.0094	Thomas	.0027		
Polk Audio	.0108	Tivo	.0645, 0663		
Profitronic	.0267	Toshiba	.0072, 0070		
Proscan	.0087, 0787	Totevision	.0064, 0267		
Protec	.0099	Unitech	.0267		
Pulsar	.0066	Vector	.0072		
Quasar	.0062, 0189, 1189	Vector Research	.0065		
RCA	.0087, 0176, 0069, 0062, .0075, 0267, 0787	Video Concepts	.0072		
Radio Shack	.0027	Videosonic	.0267		
Radix	.0064	Wards	.0062, 0087, 0027, 0074, .0267, 0069, 0075, 0099		
Randex	.0064		.0108, 0176, 0787		
		White Westinghouse	.0099, 0305, 0236		

## Digital Video Disc (DVD)

Apex	.0699
Denon	.0517
Fisher	.0697
GE	.0549
Hitachi	.0691
Hiteker	.0699
JVC	.0650, 0585
Kenwood	.0709, 0561
Konka	.0746, 0738, 0747, 0748
Magnavox	.0530, 0702
Marantz	.0566
Mitsubishi	.0548
Onkyo	.0530
Optimus	.0598
Oritron	.0678
Panasonic	.0517, 0659
Philips	.0566, 0530
Pioneer	.0598, 0552, 0659
Proscan	.0549
RCA	.0549, 0598
Samsung	.0600
Sharp	.0657
Sony	.0560
Technics	.0517
Theta Digita	.0598
Toshiba	.0530
Yamaha	.0517, 0572
Zenith	.0618, 0530



## Operating Accessory Devices with the TV Remote

Once you have programmed your TV remote, refer to page 27 to see how the remote functions with accessory devices.

Before the remote will operate an accessory device, you must select the correct mode: CBL (cable box), VCR, DVD, SAT (satellite), or AMP (amplifier).

- 1 Press the Select button to cycle through the accessory modes. When the mode you want lights up, stop pressing the button. After a few seconds, the light will begin blinking. The blinking means that the remote is in the accessory mode you have selected.

**NOTE:** The remote is in accessory mode as long as the light keeps blinking. If you do not use the remote for 60 seconds the light will switch off, and the TV will go back to TV mode. The 60-second timer restarts each time you use the remote in an accessory mode.

- 2 Point the front of the remote toward the front of the accessory device, then press the button to perform the desired function.

### HELPFUL HINT

- Press the Select button once to return the remote to the TV mode.
- Press the Select Button twice to select another device by cycling through the accessory mode choices.

### ✓ CHECK IT OUT

You can change the duration of the time-out mode by simultaneously pressing the Select button and a digit button, 1–4. Using digit 1 will set the time-out to 15 seconds; digit 2, 30 seconds; digit 3, 60 seconds; and digit 4, 120 seconds. The default time-out setting after you replace the batteries in the remote is 60 seconds. All modes will have the same time-out setting.

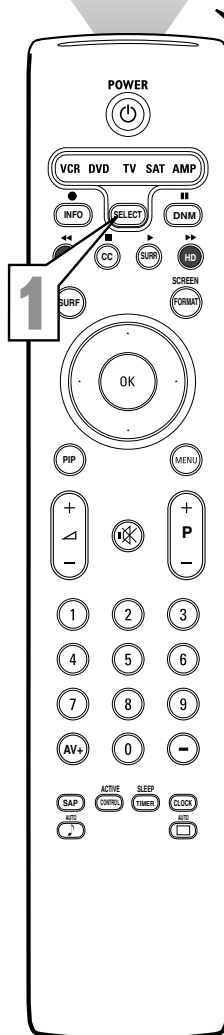
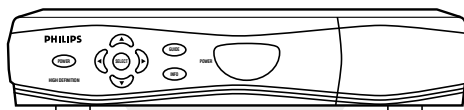

Point the front of the remote toward the front of the accessory device, then press the necessary buttons to perform the functions you desire. Refer to pages 27 to see the functions of the buttons in the respective accessory modes.

To backlight the remote control buttons, press and hold the Select button for two seconds. If you do not press any remote buttons for five seconds, the backlight switches off. Each time you press a remote button while the backlight is on, the five-second time-out function is reset. After the backlight switches off, you must press and hold the Select button for two seconds to turn it back on.



# Operating Accessory Devices with the TV Remote



## VCR Mode

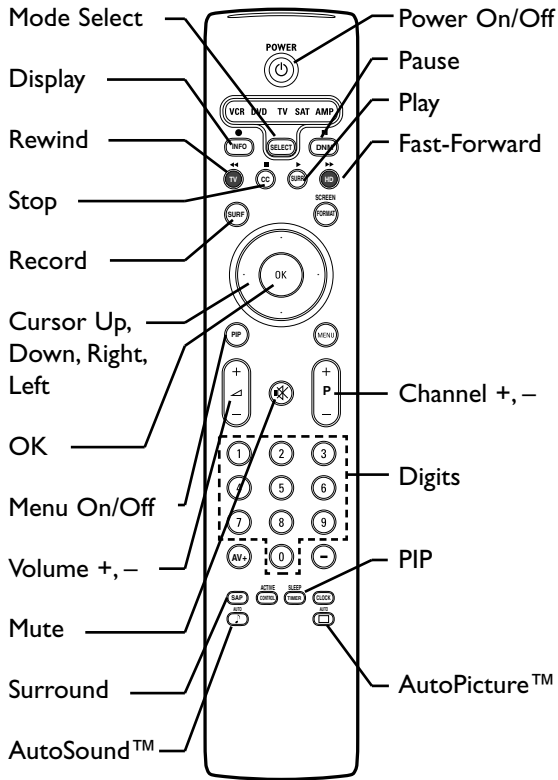

\*Point remote at TV when using this button.

## DVD Mode

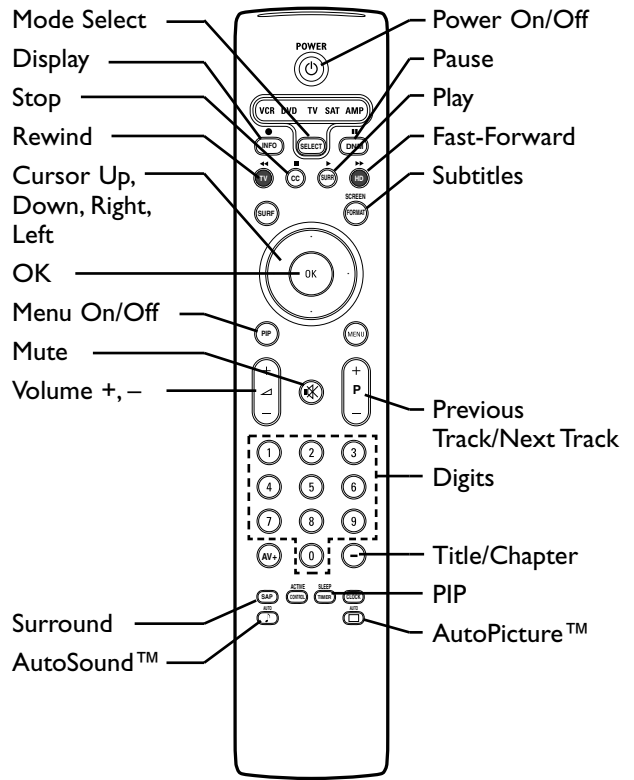

\*Point remote at TV when using this button.

## SAT Mode

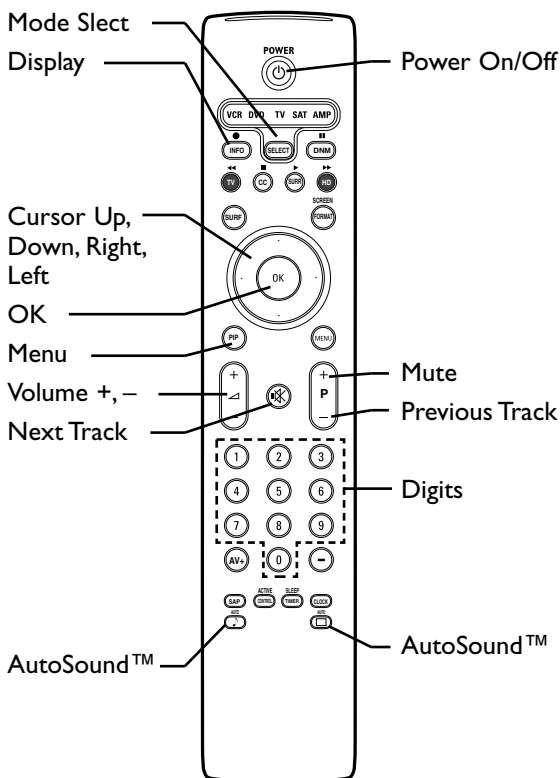

\*Point remote at TV when using this button.

## AMP Mode

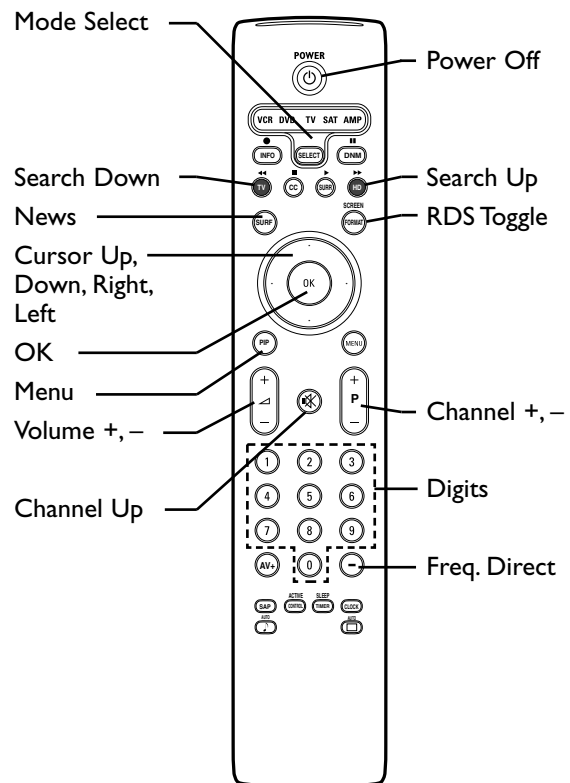

\*Point remote at TV when using this button.



# Using Active Control™ Plus

Active Control™ Plus monitors incoming video signals from the Tuner, AV1, AV2, and Side inputs and adjusts key picture settings for best picture quality. In addition to measuring picture noise, this feature uses an ambient light sensor (located on the front of the TV) to adjust the picture settings according to viewing conditions in the room. When you choose to turn Active Control™ Plus on, you have the options Minimum, Medium, or Maximum. Maximum is the recommended option.

**NOTE:** Active Control™ Plus is disabled with the AV3–AV6 input sources.

- 1** Press the Active Control™ button on the remote control to display the “Active Control” menu.
- 2** Press the Cursor Up or Down button to select one of the options: “Minimum,” “Medium,” “Maximum,” or “Off.”
- 3** Press the Cursor Right button to display the Active Control™ information window. You will notice how the values constantly change while Active Control™ is working.
- 4** Press the OK button to return to the Active Control Menu or the Menu button to remove the on-screen menu from the TV screen.

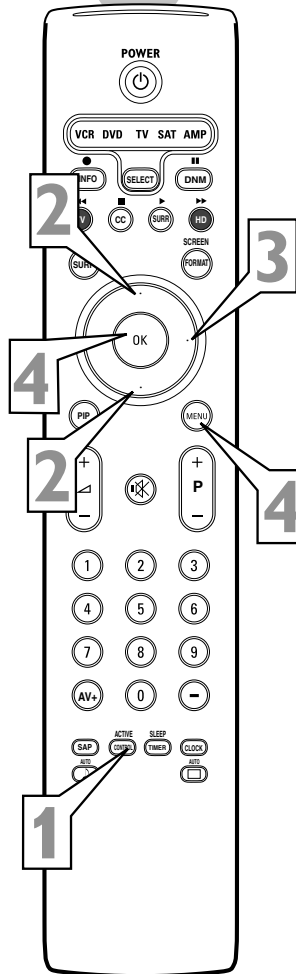
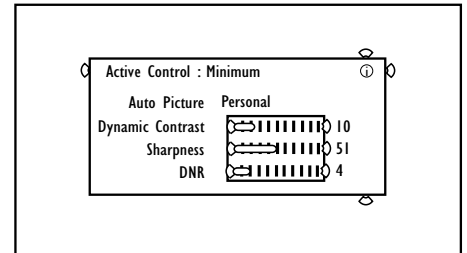
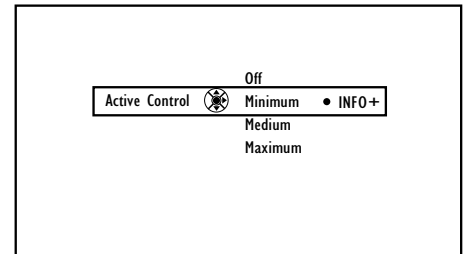
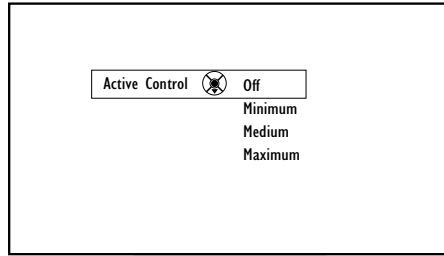

## HELPFUL HINTS

### Active Control™ Plus Settings

**Minimum**—Sharpness, Dynamic Contrast, and Noise Reduction are controlled automatically.

**Medium**—Sharpness, Color, Dynamic Contrast, and Noise Reduction are controlled automatically.

**Maximum**—Sharpness, Color, Dynamic Contrast, Noise Reduction, and Contrast are controlled automatically.

# Selecting an AutoPicture™ Option



Whether you're watching a movie or playing a video game, your TV has automatic video control settings to match your current program source or content. AutoPicture™ quickly resets your TV's video controls for a number of different types of programs and viewing conditions that you may have in your home. The Personal AutoPicture™ settings are the same as the Picture control adjustments made within the on-screen menu.

- 1 Press the Menu button on the remote to display the on-screen menu.
- 2 Press the Cursor Right button to select "Picture."
- 3 Press the Cursor Down button repeatedly until the "Auto picture" control is selected.
- 4 Press the Cursor Right button to enter the AutoPicture™ submenu.
- 5 Press the Cursor Down or Up button to select one of the AutoPicture™ options: "Personal," "Rich," "Natural," "Soft," "Multimedia," or "Eco."
- 6 Press the Menu button to remove the on-screen menu from the TV screen.
- 7 You can also select the AutoPicture™ settings directly by pressing the AutoPicture™ button on the remote control.

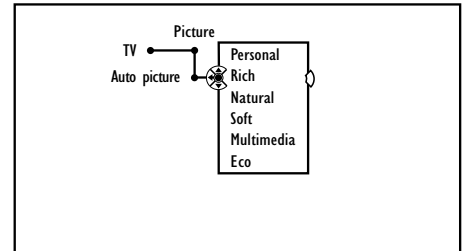
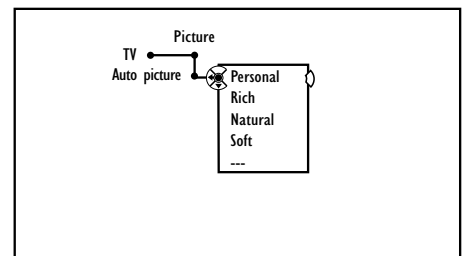
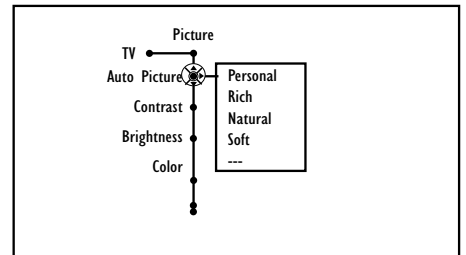
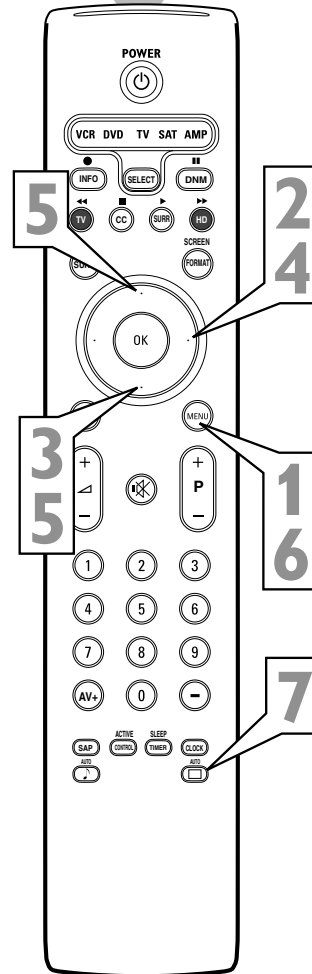
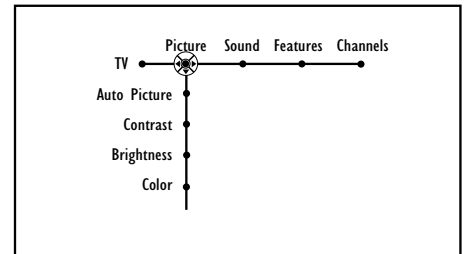
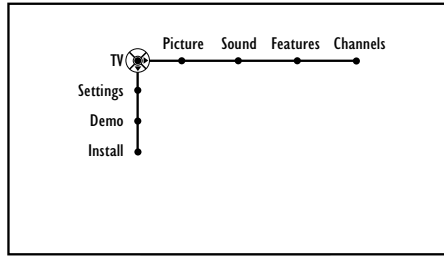

## HELPFUL HINTS

### AutoPicture™ Options

**Personal** settings are based on your personal choice or viewer control preferences.

**Rich** emphasizes very vibrant colors. (This is a good choice when AV mode is used in a brightly lighted room.)

**Natural** sets picture controls at mid-level settings for consistent viewing conditions.

**Soft** emphasizes warm colors. (This is a good choice for dimly lighted room. It gives a cinema-like effect when the light is switched off.)

**NOTE:** This option can also be used with the PixelPlus™ control to soften the appearance of harsh screen elements that can show with certain types of DVD playback conditions. See page 30 for information about PixelPlus™.

**Multimedia** emphasizes soft colors. (This is a good choice for playing computer games, for example.)

**B&W** optimizes brightness and contrast settings for viewing black and white programs.

**NOTE:** The Personal option shows the personal settings made in the Picture submenu. When you select one of the preset AutoPicture™ options, those settings become the Personal settings.

# Adjusting/Setting the Picture Controls

To adjust your TV picture controls, select a channel and follow these steps.

- 1** Press the Menu button on the remote control to show the on-screen menu.
- 2** Press the Cursor Right button to select "Picture."
- 3** Press the Cursor Down button to select one of the picture adjustments: "Contrast," "Brightness," "Color," "Sharpness," "Color temperature," or "Tint."

**NOTE:** The menu will show only four items at a time, so you will need to continue scrolling with the Cursor Down button to adjust the color temperature and tint.

- 4** Press the Cursor Left or Cursor Right button to adjust the selected control. Or, if color temperature is chosen, press the Cursor Right button to choose from the options "Normal," "Warm," or "Cool."
- 5** Press the Menu button to remove the on-screen menu from the TV screen.

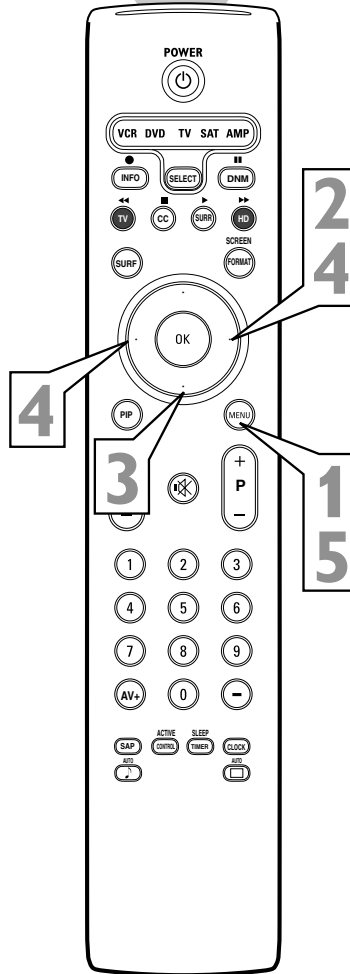
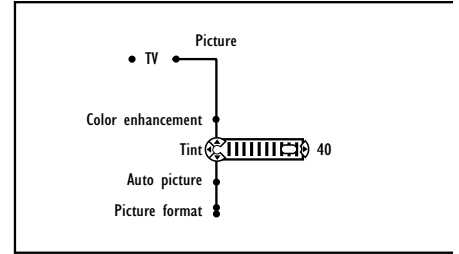
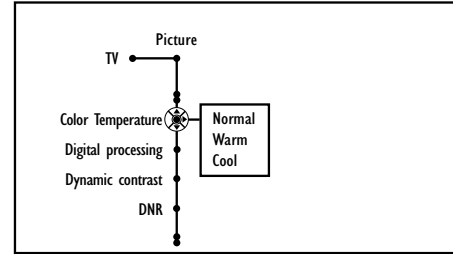
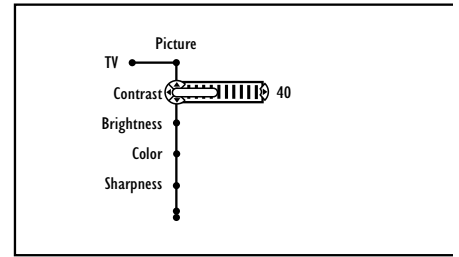
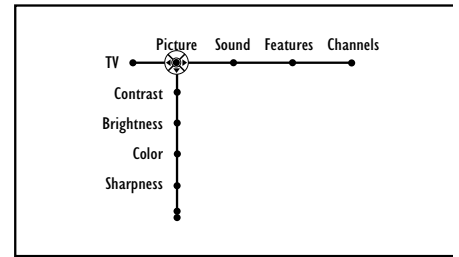
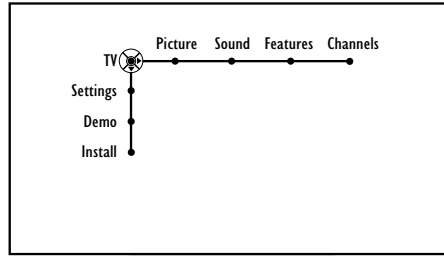

## HELPFUL HINTS

- The tint control is not available with the AV3 - AV6 input sources.
- Picture Control Settings**
- **Brightness** adds or subtracts light from the darkest part of the picture.
  - **Color** adds or eliminates color.
  - **Sharpness** improves the detail in the picture.
  - **Tint** adjusts the picture to obtain natural skin tones.
  - **Color temperature** offers "Normal," "Cool," or "Warm" picture preferences.
  - **Normal** keeps whites, white.
  - **Cool** makes whites, bluish.
  - **Warm** makes whites, reddish.

# Selecting a Digital Processing Option



The Digital Processing control gives you a choice of different picture scanning modes.

**Progressive Scan** doubles the number of picture lines, eliminating line flicker and providing a jitter-free picture.

**Movie Plus** provides motion compensation to increase clarity around moving images in the picture.

- 1** Press the Menu button on the remote to display the on-screen menu.
- 2** Press the Cursor Right button to select "Picture."
- 3** Press the Cursor Down button repeatedly until the "Digital processing" control is selected.
- 4** Press the Cursor Right button to enter the digital processing submenu.
- 5** Press the Cursor Up or Down button to select Progressive Scan, or Movie Plus.
- 6** Press the Menu button to remove the on-screen menu from the TV screen.

## HELPFUL HINT

The Digital Processing control is not available for use with the AV3, AV4, AV5, or AV6 input sources.

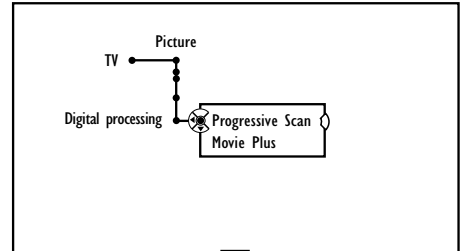
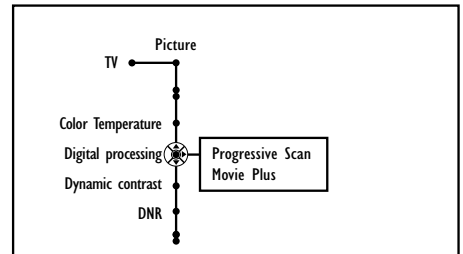
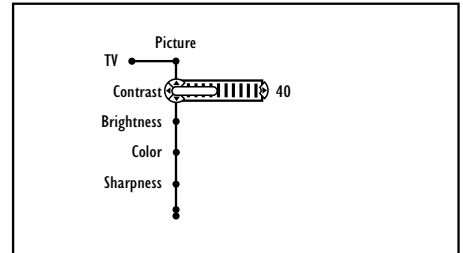
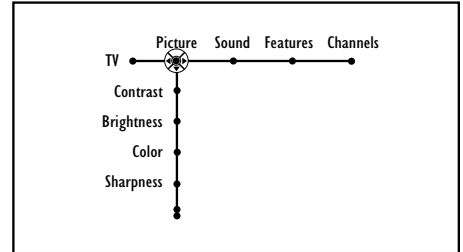
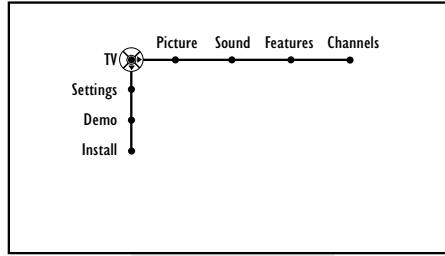

OR

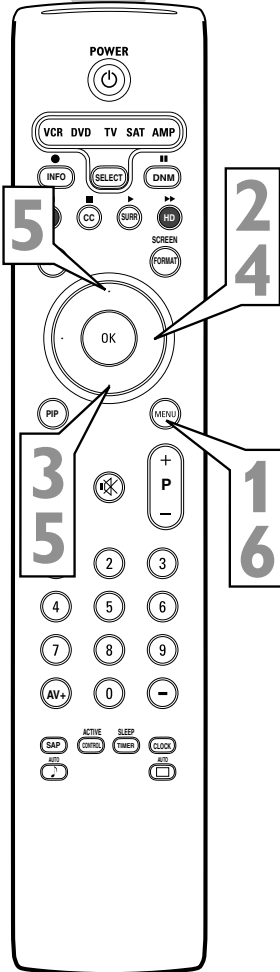
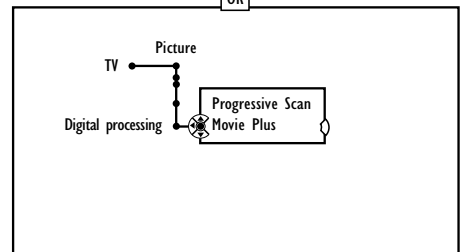

# Selecting a Dynamic Contrast Option

The Dynamic Contrast control allows you to sharpen the picture quality by making dark portions of the picture darker and light portions of the picture more noticeable. Normally, you will probably want to select Medium. In certain circumstances, however, you may prefer Minimum or Maximum.

- 1** Press the Menu button on the remote to display the on-screen menu.
- 2** Press the Cursor Right button to select Picture.
- 3** Press the Cursor Down button repeatedly until the “Dynamic contrast” control is selected.
- 4** Press the Cursor Right button to enter the Dynamic Contrast submenu.
- 5** Press the Cursor Up or Down button to select one of the Dynamic Contrast options: “Off,” “Minimum,” “Medium,” or “Maximum.”
- 6** Press the Menu button to remove the on-screen menu from the TV screen.

## HELPFUL HINT

The Dynamic Contrast control is not available for use with input sources AV3–AV6.

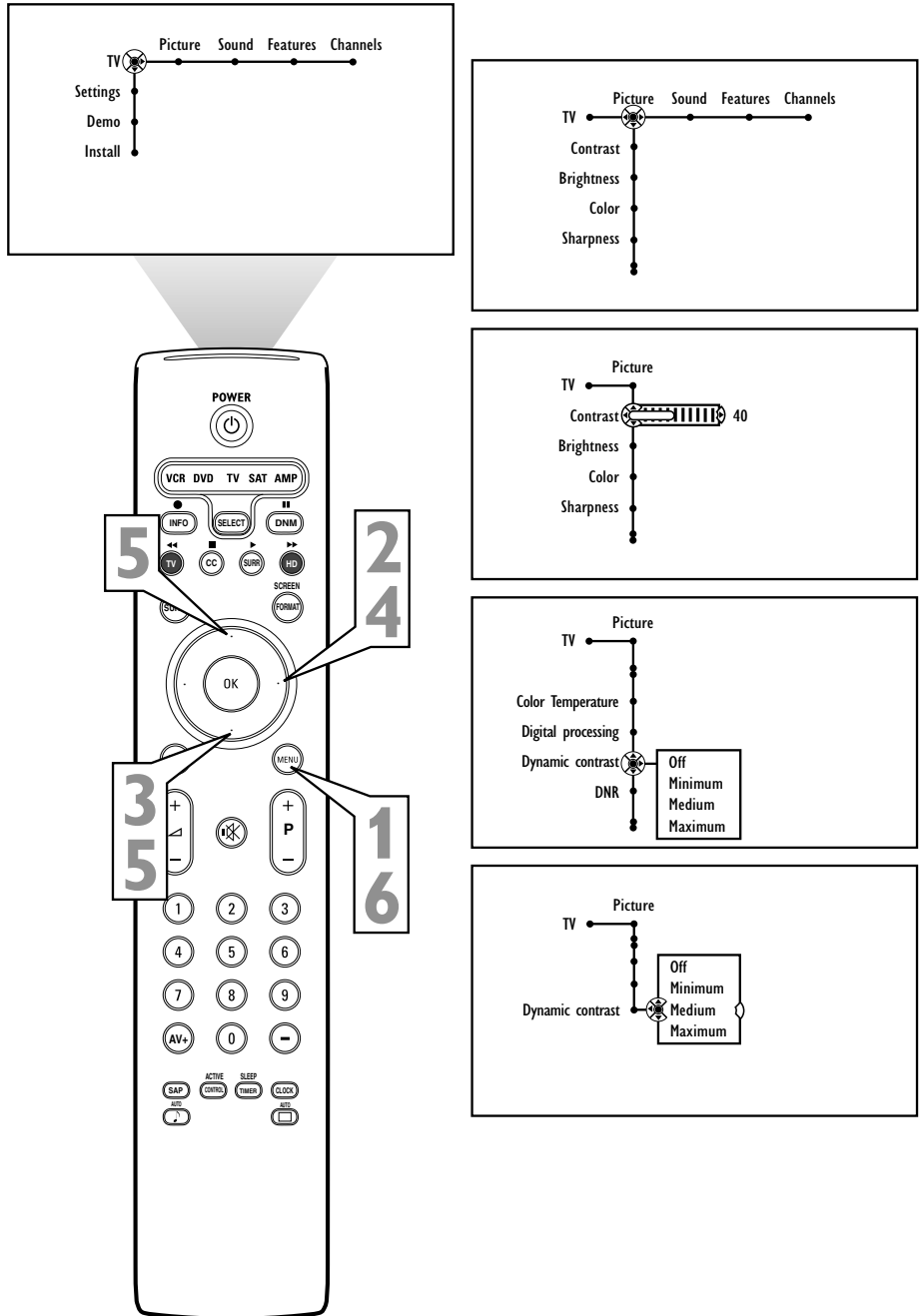



# Selecting a DNR (Dynamic Noise Reduction) Option



For many reasons, one of which is poor cable reception, the picture can sometimes appear slightly “speckled” (an indication of signal noise in the picture). The DNR (Dynamic Noise Reduction) control can help eliminate this type of interference and improve the quality of the picture.

- 1** Press the Menu button on the remote to display the on-screen menu.
- 2** Press the Cursor Right button to select “Picture.”
- 3** Press the Cursor Down button repeatedly until the DNR control is selected.
- 4** Press the Cursor Right button to enter the DNR submenu.
- 5** Press the Cursor Up or Down button to select one of the DNR options: Off, Minimum, Medium, or Maximum.
- 6** Press the Menu button to remove the on-screen menu from the TV screen.

## HELPFUL HINT

DNR is not available for use with input sources AV3–AV6.

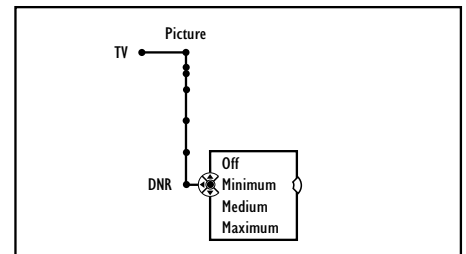
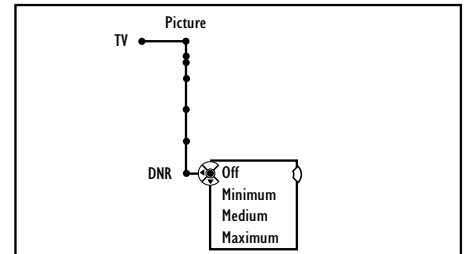
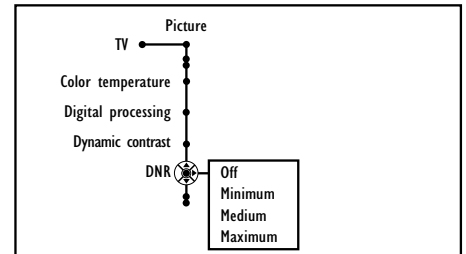
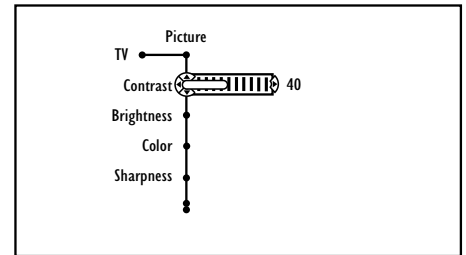
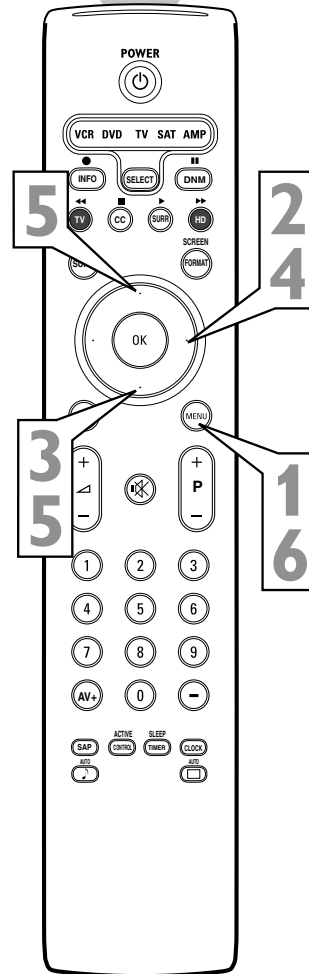
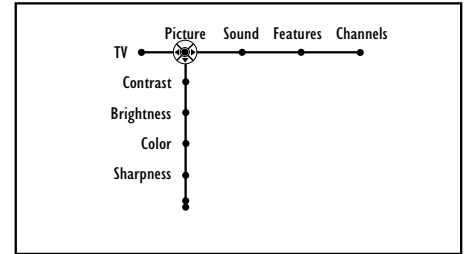
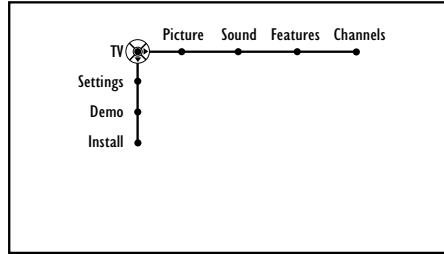



# Turning on Color Enhancement

The Color Enhancement control can improve the picture quality of pictures with a high saturation of color. This control works in four ways:

**Dynamic Blue Stretch** corrects the white colors toward a more bluish-colored white without changing the other colors. Improves the sharpness of the picture.

**Green Enhancement** offers a more saturated green color in case of low green broadcasts, giving landscapes a fresher and brighter look.

**Color-dependent Sharpness** improves the sharpness of the picture through the color information. Gives the picture more details, especially in red colors.

**Skin-tone Correction** adjusts for over saturation of red that often appears in skin tones.

- 1** Press the Menu button on the remote to display the on-screen menu.
- 2** Press the Cursor Right button to select "Picture."
- 3** Press the Cursor Down button repeatedly until the "Color enhancement" control is selected.
- 4** Press the Cursor Right button to turn the color enhancement control on or off.
- 5** Press the Menu button to remove the on-screen menu from the TV screen.

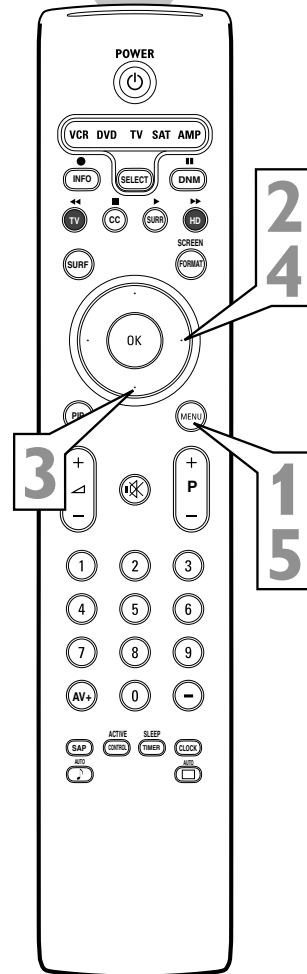
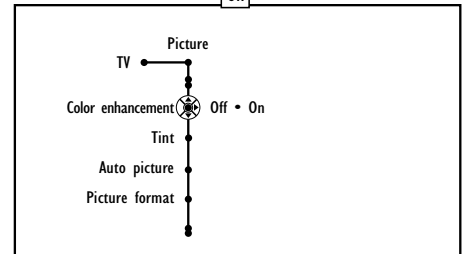
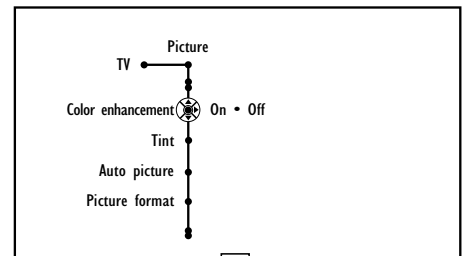
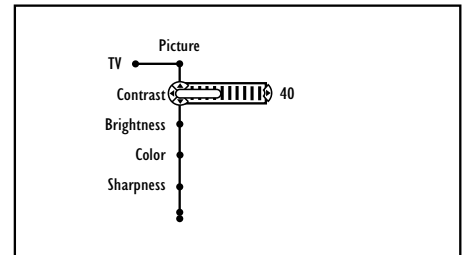
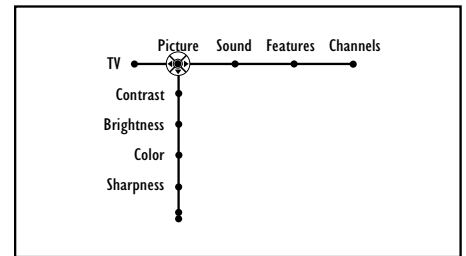
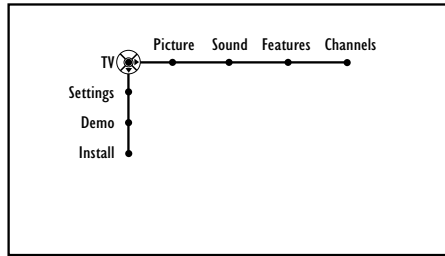

## HELPFUL HINT

The color enhancement control is not available for use with inputs AV3–AV6.

# Selecting a Picture Format Option



Your TV's wide screen (16:9 aspect ratio) delivers a home-cinema experience that isn't possible with a conventional (4:3 aspect ratio) set. The 16:9 format of high-definition (HD) programs and other widescreen-format video sources appear more lifelike, dramatic, and theatrical. Black or gray bars are diminished or eliminated. As the television industry moves toward the high-definition format standard and more HD broadcasts become available, you will be able to see the broadcasts as they were intended—in 16:9 format.

For flexibility in viewing conventional 4:3-format video sources on your TV's wide screen, you have the options Automatic, "Super zoom," "Panoramic," "4:3," "Movie expand 14:9," "Movie expand 16:9," "16:9 subtitle," or "Wide screen."

**NOTE:** The Automatic picture format is disabled for AV3–AV6.

Page 36 explains how to select a picture format option.

## CHECK IT OUT

Inputs AV3–AV4 allow horizontal and vertical picture panning using the Cursor Left, Right, Up, and Down buttons. The Side input allows vertical picture panning; left and right panning with the Side input is possible when the input has been labeled "Game." See pages 18 and 19 for details on side panel connections and source labeling.

## HELPFUL HINT

The term *aspect ratio* refers to the relationship between the width and height of a TV screen. Historically, TV screen width has been 33 percent greater than its height, amounting to a 4:3 aspect ratio. The width of your widescreen TV, however, is nearly 80 percent greater than its height, which means its aspect ratio is 16:9. This screen corresponds well with the tendency of the eyes to feel more comfortable with fields of view and action planes that are horizontally oriented. The wide screen is also proportionally truer to the formats in which movies are filmed and presented in theaters. However, many widescreen DVDs will still display black bars to preserve the true theatrical format.

Conventional 4:3 Screen Size



Your TV's 16:9 Screen Size

## Your TV's Picture Format Options

### Automatic (not depicted)

Makes the picture fill the screen as much as possible when the presence of black or gray bars is detected.



### Panoramic

Evenly stretches the edges of the picture to fill the TV's wide screen.



### Super zoom

Removes the black or gray bars on the sides of a 4:3-format picture with minimal distortion. Part of the top and bottom portions of the picture are excluded from the screen.



### Movie expand 14:9

Expands the picture to 14:9 movie aspect ratio. Part of the top and bottom portions of the picture are excluded from the screen. Black or gray bars are shown at the left and right sides.



### 4:3

Displays a conventional 4:3 picture without change. Black or gray bars will show at the left and right sides.



### 16:9 subtitle

Zooms the picture for a full view of subtitles or other information displayed at the bottom of the picture. Part of the top portion of the picture is excluded from the screen.



### Movie expand 16:9

Alters the image both horizontally (stretched) and vertically (cropped) to fill the TV's wide screen. Part of the top and bottom portions of the picture will be excluded from the screen.



### Wide screen

Evenly stretches the width of the picture to fill the screen.



# Selecting a Picture Format Option

Choose a picture format size to match the type of program you're watching. Select the normal 4:3 aspect ratio or a variety of widescreen formats.

- 1** Press the Menu button on the remote to display the on-screen menu.
- 2** Press the Cursor Right button to select "Picture."
- 3** Press the Cursor Down button repeatedly until the "Picture format" control is selected.
- 4** Press the Cursor Right button to enter the picture-format submenu.
- 5** Press the Cursor Down button to select one of the seven screen formats: "Automatic," "Super zoom," "Panoramic," "4:3," "Movie expand 14:9," "Movie expand 16:9," "16:9 subtitle," or "Wide screen." The Automatic option senses the presence of black or gray bars around the picture and zooms the picture to reduce or eliminate the bars.
- 6** Press the Menu button to remove the on-screen menu from the TV screen.
- 7** You can also select a picture format simply by pressing the Screen Format button on the remote control.

**NOTE:** The Automatic picture format option is not available with AV5 (computer) connections.

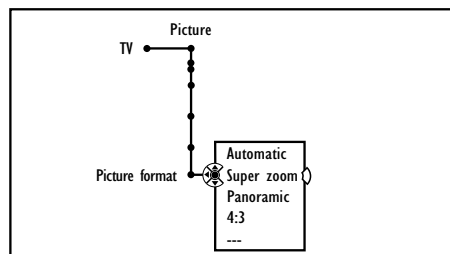
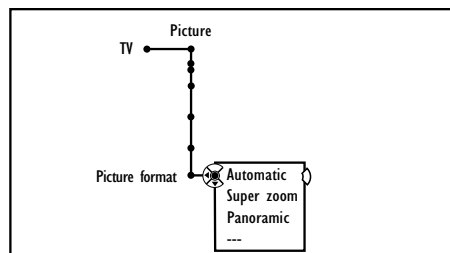
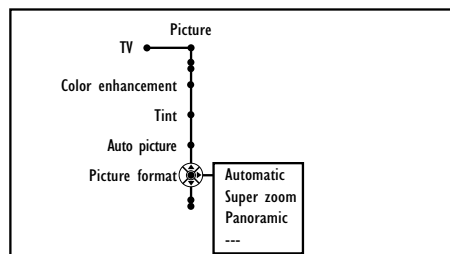
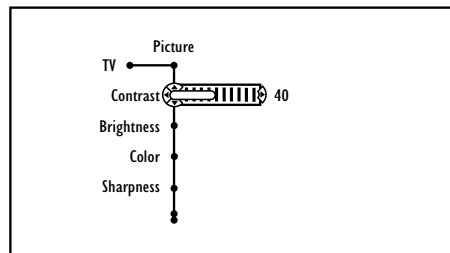
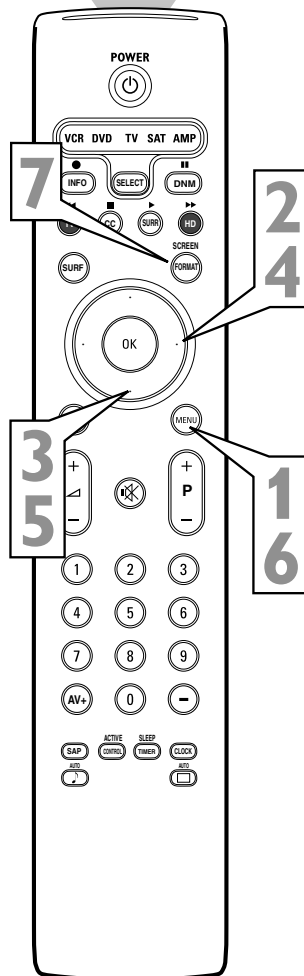
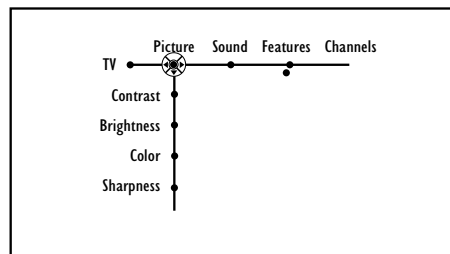
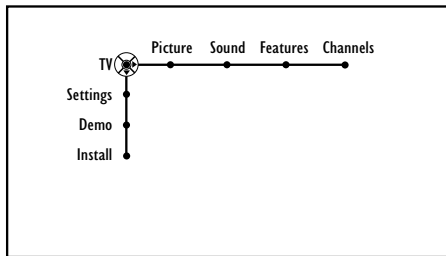

# Adjusting the TV and Headphone Volume



Besides the normal volume level control, your TV also has a headphone volume control. This control can be adjusted when using headphones without having to adjust the main volume control for the TV cabinet speakers.

## To control the television volume:

- 1 Press the Volume + button on the remote control to increase the television volume level.
- 2 Press the Volume – button on the remote control to decrease the television volume level.

## NOTES:

- The Volume scroll will not appear on screen if the on-screen display is set to “Minimum.” See page 62 for details.
- The Volume level can also be adjusted within the on-screen menu. Select the Sound menu and cursor down to the Volume control. Use the Cursor Left and Right buttons to adjust.

## To control the Headphone volume:

- 3 Press the Menu button on the remote control to display the on-screen menu.
- 4 Press the Cursor Right button to select “Sound.”
- 5 Press the Cursor Down button repeatedly until the “Headphone volume” control is selected.
- 6 Press the Cursor Right button to increase the headphone volume level.
- 7 Press the Cursor Left button to decrease the headphone volume level.
- 8 Press the Menu button on the remote control to remove the on-screen menu from the TV screen.

Television Volume

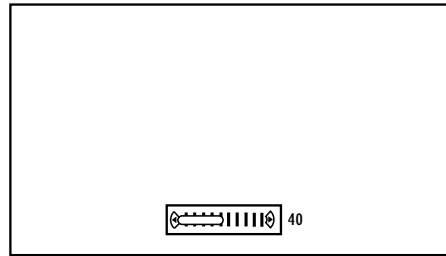

Headphone Volume

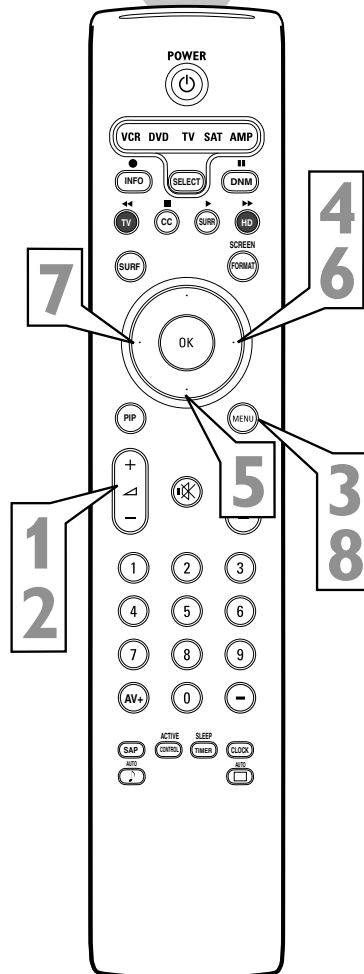
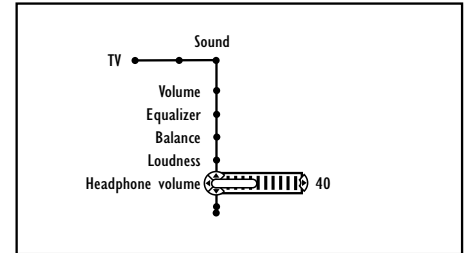
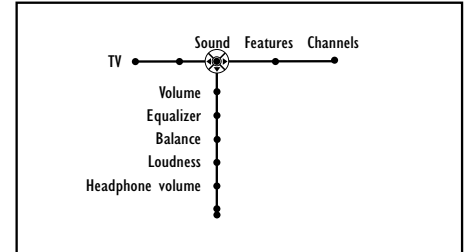
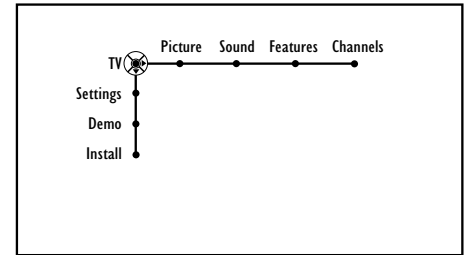

Plug your headphones into the headphone 3.5mm mini-jack in the TV's Side panel.

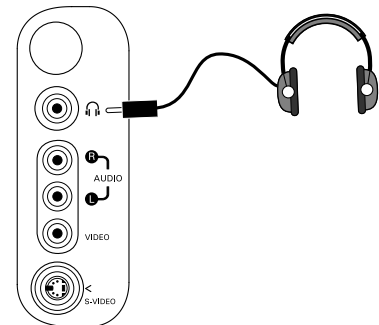



# Selecting an AutoSound™ Option

AutoSound™ allows you to select from four factory-set controls and a personal control. The personal control consists of settings you adjust through the on-screen Sound menu. The four factory-set controls—Speech, Music, Movie, or Multimedia—enable you to tailor the TV sound to enhance the particular program you are watching. Follow these steps to select any of the options.

- 1** Press the Menu button on the remote to display the on-screen menu.
- 2** Press the Cursor Right button repeatedly to select “Sound.”
- 3** Press the Cursor Down button repeatedly until the “Auto sound” control is selected.
- 4** Press the Cursor Right button to enter the AutoSound™ submenu.
- 5** Press the Cursor Up or Down button to select an option: “Speech,” “Music,” “Movies,” “Multimedia,” or “Personal.”
- 6** Press the Menu button to remove the on-screen menu from the TV screen.
- 7** You can also select the AutoSound™ settings directly by pressing the AutoSound™ button on the remote control.

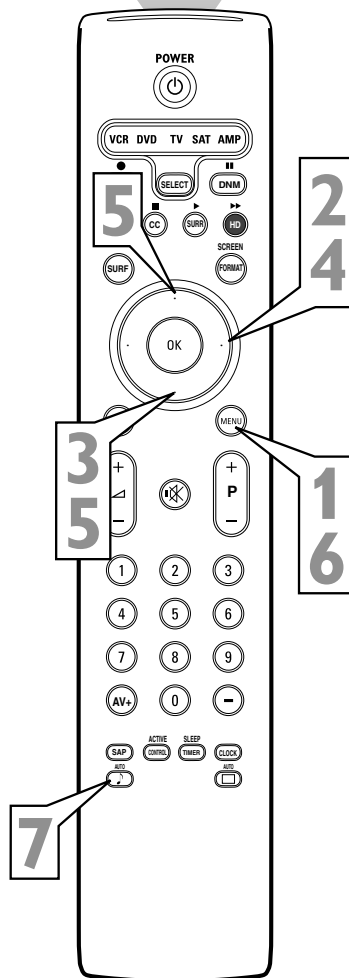
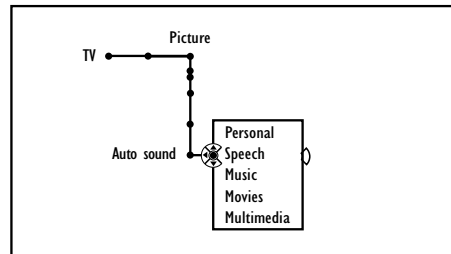
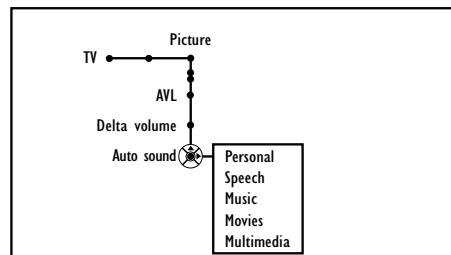
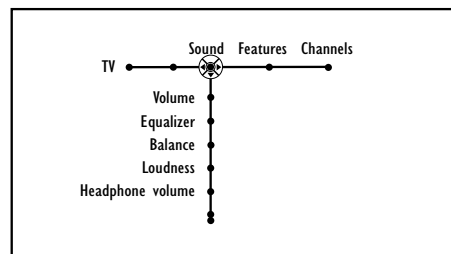
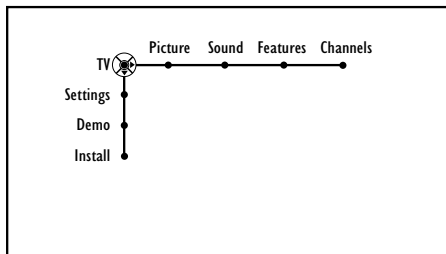

## HELPFUL HINTS

### AutoSound™ Options

**Speech** brings voices to the forefront and emphasizes them. Moves music to the background.

**Music** emphasizes music over voices.

**Movies** provides a balance between voices and music.

**Multimedia** provides sound balance best suited for gaming consoles or interactive media.

**Personal** presents the TV’s sound according to the settings you make within the sound menu.

**NOTE:** The Personal option shows the personal settings made in the Sound submenu. When you select one of the preset AutoSound™ options, those settings become the Personal settings.

# Selecting a TV Equalizer Option



The Equalizer control will change the dynamics of the sound being heard through the TV. You can adjust the settings for the Personal Equalizer option. The other options have been preset at the factory and cannot be changed.

- 1** Press the Menu button on the remote to display the on-screen menu.
- 2** Press the Cursor Right button repeatedly to select "Sound."
- 3** Press the Cursor Down button repeatedly until the "Equalizer" control is selected.
- 4** Press the Cursor Right button to enter the equalizer submenu. Continue to press the Cursor Right button to select one of the options: "Speech," "Music," "Movie," "Multimedia," or "Personal."
- 5** If you select the Personal option and want to make adjustments, press the Cursor Down button to select an adjustment, then press the Cursor Left or Right button to adjust the slider control to the desired position.

**NOTE:** If you attempt to change the settings for the factory preset options Speech, Music, Movie, or Multimedia, the Equalizer control will default to the Personal option.

- 6** Press the Menu button to remove the on-screen menu from the TV screen.

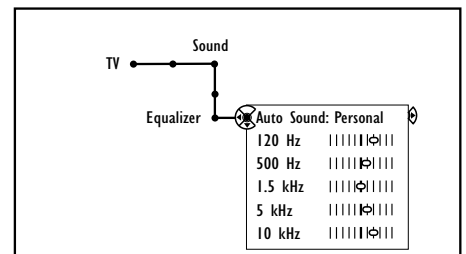
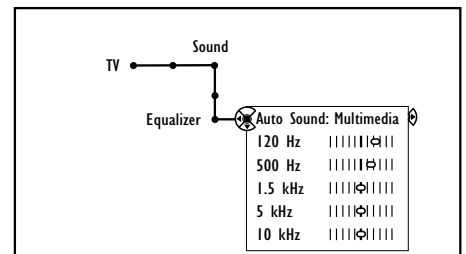
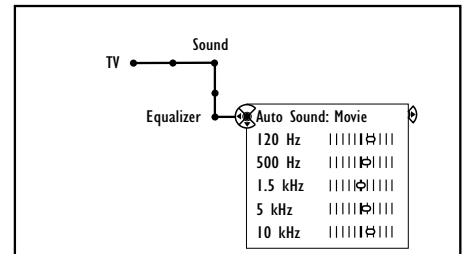
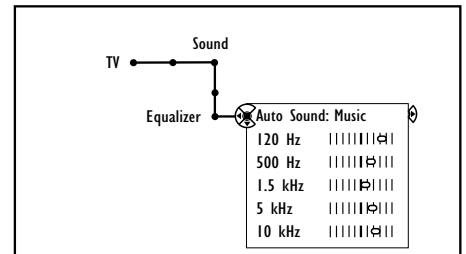
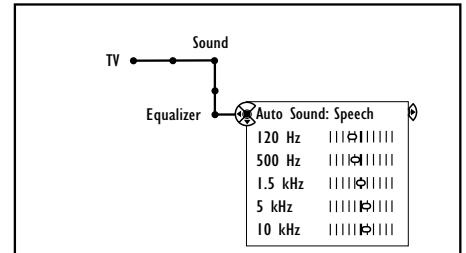
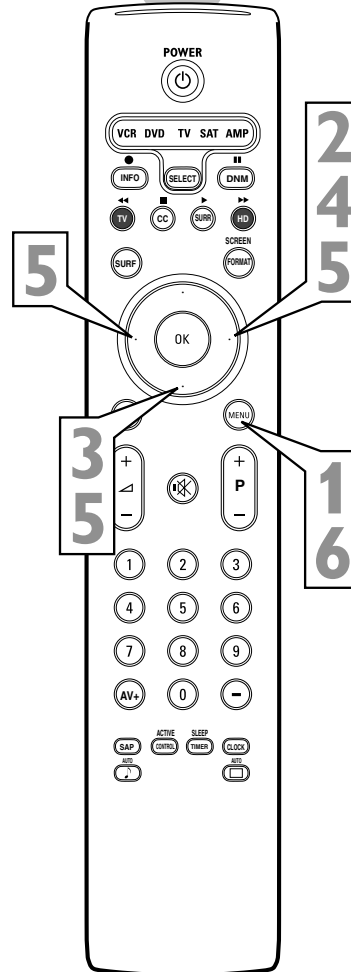
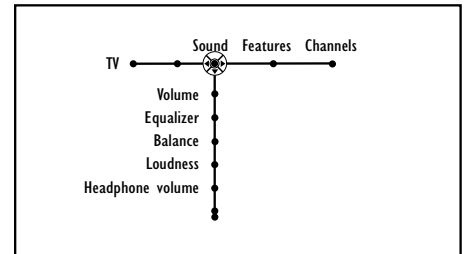
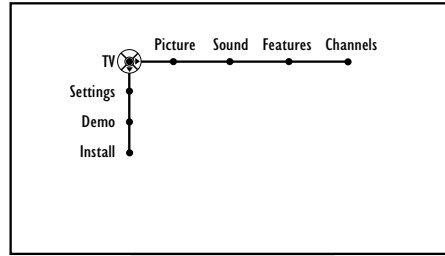



# Adjusting TV Speaker Balance

You can adjust the balance of the TV speaker sound.

- 1** Press the Menu button on the remote to display the on-screen menu.
- 2** Press the Cursor Right button repeatedly to select "Sound."
- 3** Press the Cursor Down button repeatedly until the "Balance" control is selected.
- 4** Press the Cursor Right or Left button to adjust speaker balance.
- 5** Press the Menu button to remove the on-screen menu from the TV screen.

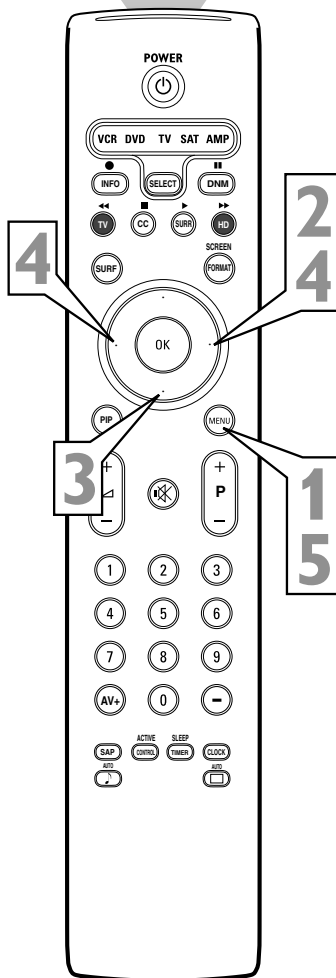
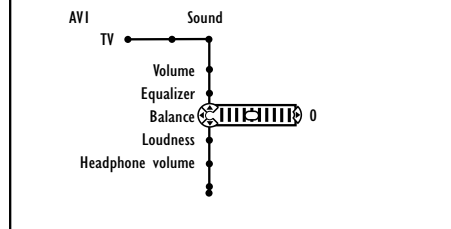
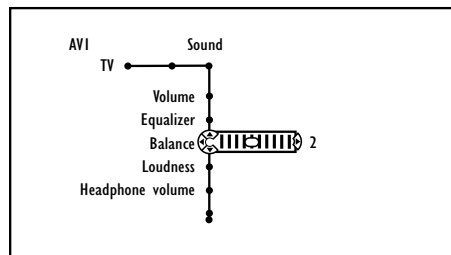
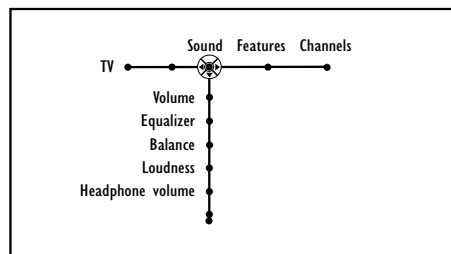
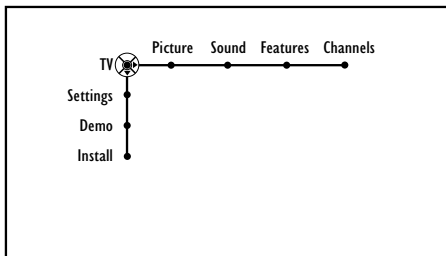



# Turning Loudness on or off



Turning the Loudness control on provides a volume-dependent bass-boost effect to the speakers. Follow the steps here to turn the Loudness control on.

- 1** Press the Menu button on the remote to display the on-screen menu.
- 2** Press the Cursor Right button repeatedly to select “Sound.”
- 3** Press the Cursor Down button repeatedly until the “Loudness” control is selected.
- 4** Press the Cursor Right to toggle loudness on or off.
- 5** Press the Menu button to remove the on-screen menu from the TV screen.

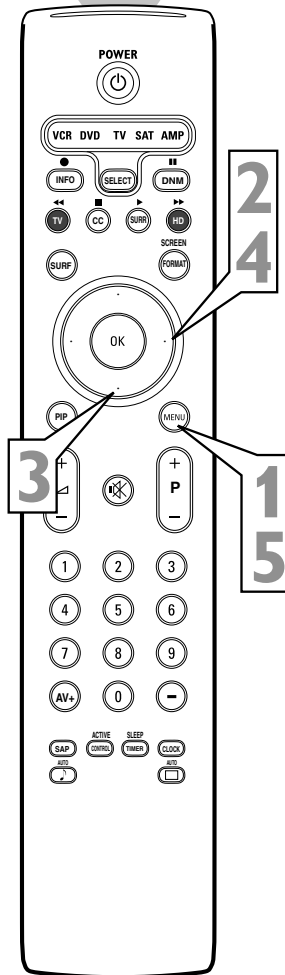
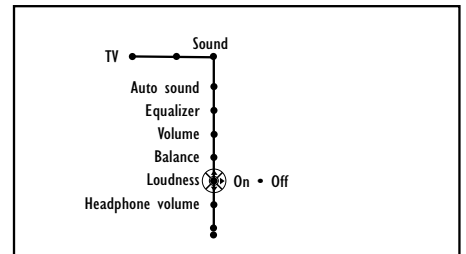
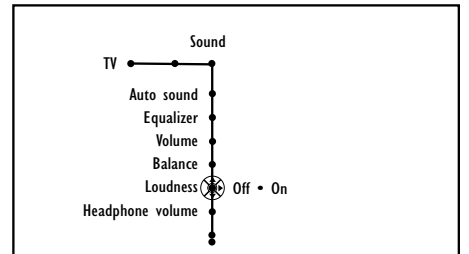
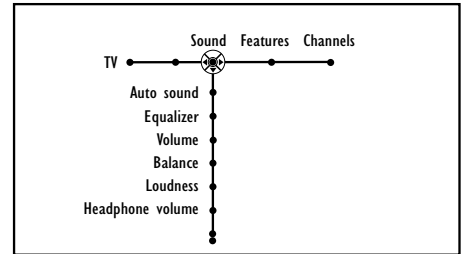
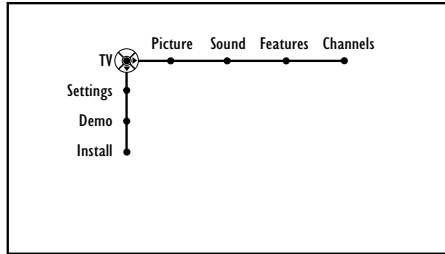



# Selecting a Sound Mode Option

The Sound Mode control allows you to place the TV sound into either Incredible Surround™ or Dolby® Virtual mode. The steps below explain how to select one of those options.

- 1** Press the Menu button on the remote to display the on-screen menu.
- 2** Press the Cursor Right button repeatedly to select “Sound.”
- 3** Press the Cursor Down button repeatedly until the “Sound mode” control is selected.
- 4** Press the Cursor Right button to enter the sound mode submenu.
- 5** Press the Cursor Up or Down button to select one of modes, either “Incr. Surround” or “Dolby Virtual.”
 

**Incr. Surround** enhances stereo programs by making the sound broader and fuller.

**Dolby Virtual** creates a virtualized surround-sound experience from two speakers. Dolby Virtual retains all the original multichannel audio information and provides the listener with the sensation of being surrounded by additional speakers.
- 6** When finished, press the Menu button to remove the on-screen menu from the TV screen.
- 7** You can also select a sound mode option simply by pressing the Surround Sound button on the remote control.

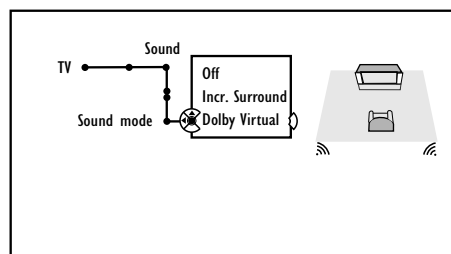
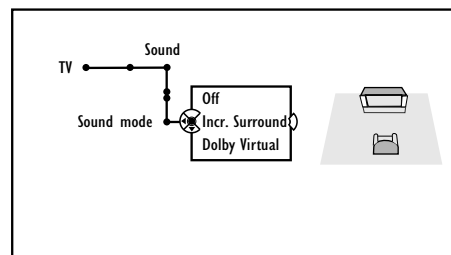
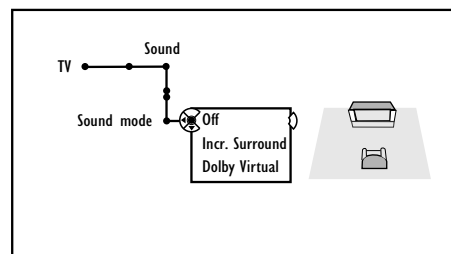
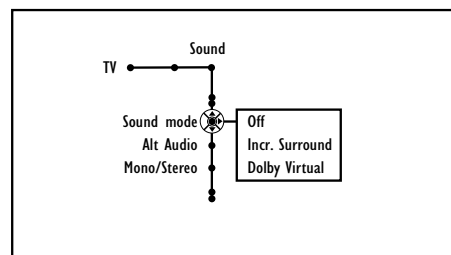
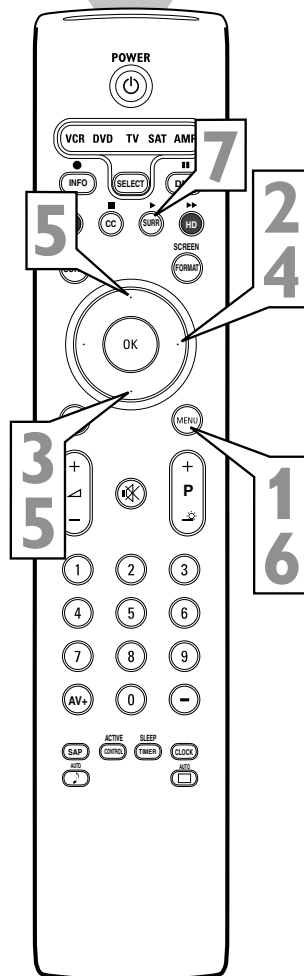
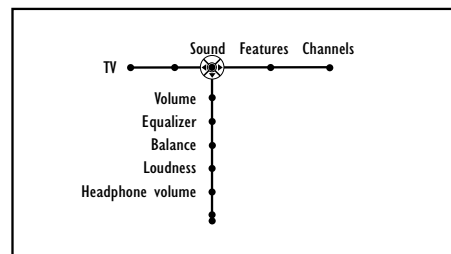
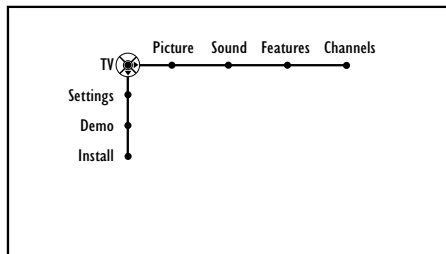

\*Manufactured under license from Dolby Laboratories. “Dolby” and the double-D symbol are trademarks of Dolby Laboratories.

Incredible Surround is a trademark of Philips Consumer Electronics. Copyright 2004 Philips Consumer Electronics. All rights reserved.

# Using Alternate Audio (SAP)



For broadcasts that contain SAP (Secondary Audio Program) information, the Alt Audio Control can be set to SAP. Sent as a third audio channel, SAP is an additional part of the stereo broadcast system that can be heard apart from the current TV program sound. TV stations are free to use SAP for any number of purposes.

If an SAP signal is not present with a selected program, the “Alt Audio” option in the TV’s on-screen menu cannot be selected and will appear grayed out.

If SAP is available on the tuned channel:

- 1** Press the Menu button on the remote to display the on-screen menu.
- 2** Press the Cursor Right button repeatedly to select “Sound.”
- 3** Press the Cursor Down button repeatedly until the Alt Audio control is selected.
- 4** Press the Cursor Right button to toggle and select either “Main” or “SAP.”
- 5** Press the Menu button to remove the on-screen menu from the TV screen.
- 6** You can also select SAP by simply pressing the Alternate Audio button on the remote control.

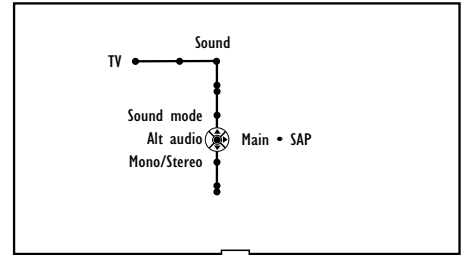
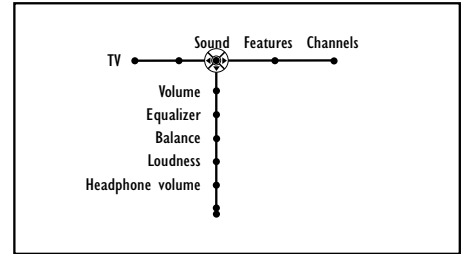
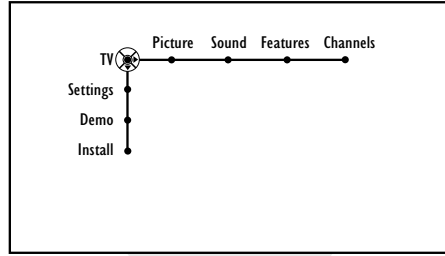

OR

