

SAFETY AND
TROUBLESHOOTING

ABOUT
THIS MANUAL

PRODUCT
INFORMATION

INSTALLING
YOUR MONITOR

ON-SCREEN
DISPLAY

TV CONTROL

CUSTOMER CARE
AND WARRANTY

DOWNLOAD
AND PRINT

EXIT

**ELECTRONIC
USER'S
MANUAL**



150MT

LCD MONITOR/TV

Safety and Troubleshooting Information

[Safety Precautions and Maintenance](#) • [Installation Locations](#) • [FAQs](#) • [Troubleshooting](#) • [Regulatory Information](#) • [Other Related Information](#)

Safety precautions and maintenance



WARNING: Use of controls, adjustments or procedures other than those specified in this documentation may result in exposure to shock, electrical hazards and/or mechanical hazards.

Read and follow these instructions when connecting and using your computer monitor:

- Unplug the monitor if you are not going to use it for an extensive period of time.
- Unplug the monitor if you need to clean it with a slightly damp cloth. The screen may be wiped with a dry cloth when the power is off. However, never use alcohol, solvents or ammonia-based liquids.
- Consult a service technician if the monitor does not operate normally when you have followed the instructions in this manual.
- The casing cover should be opened only by qualified service personnel.
- Keep the monitor out of direct sunlight and away from stoves or any other heat source.
- Remove any object that could fall into the vents or prevent proper cooling of the monitor's electronics.
- Do not block the ventilation holes on the cabinet.
- Keep the monitor dry. To avoid electric shock, do not expose it to rain or excessive moisture.
- When positioning the monitor make sure the power plug and outlet are easily accessible.
- If turning off the monitor by detaching power cable or DC power cord, wait for 6 seconds before attach the power cable or DC power cord for normal operation.
- To avoid the risk of shock or permanent damage to the set do not expose the monitor to rain or excessive moisture.
- When positioning the monitor, make sure the power plug and outlet are easily accessible.
- **IMPORTANT:** Always activate a screen saver program during your application. If a still image in high contrast remains on the screen for an extended period of time, it may leave an 'after-image' or 'ghost image' on the front of the screen. This is a well-known phenomenon that is caused by the shortcomings inherent in the LCD technology. In most cases the after-image will disappear gradually over a period of time after the power has been switched off. Be aware that the after-image symptom cannot be repaired and is not covered under warranty.

Consult a service technician if the monitor does not operate normally when the operating instructions given in this manual have been followed.

[RETURN TO TOP OF THE PAGE](#)

Installation Locations

- Avoid exposure to heat and extreme cold
- Do not store or use the product in locations exposed to heat, direct sunlight or extreme cold.
- Avoid moving the product between locations with large temperature differences. Choose a site that falls within the following temperature and humidity ranges.
 - Temperature: 5-35°C 41-95°F
 - Humidity: 20-80% RH
- Do not subject the product to severe vibration or high impact conditions. Do not place the product inside a car boot.
- Take care not to mishandle this product by either knocking or dropping during operation or transportation.
- Do not store or use the product in locations where there is a high level of humidity or in dusty environments. Do not allow water or other liquids to spill on or into the product.

[RETURN TO TOP OF THE PAGE](#)

About This Manual

[About This Guide](#) • [Notational Descriptions](#)

About This Guide

This electronic user's guide is intended for anyone who uses the Philips LCD Monitor TV. It describes the features, setup, operation and other important information.

It includes the following sections:

- [Safety and Troubleshooting Information](#) provides tips and solutions for common problems as well as other related information you may need.
- About This Electronic User's Manual gives an overview of information included, along with notation icon descriptions and other documentation for your reference.
- [Product Information](#) gives an overview of the monitor's features as well as the technical specifications for this monitor.
- [Installing Your Monitor](#) describes the initial setup process and gives an overview of how to use the monitor.
- [On-Screen Display](#) provides information on adjusting the settings on your monitor.
- [TV Control](#) provides information on adjusting the settings for your TV function.
- [Customer Care and Warranty](#) contains a list of worldwide Philips Consumer Information Centres along with help desk phone numbers and information on the warranty applicable to your product.
- [Download and Print Option](#) transfers this entire manual to your hard drive for easy reference.

[RETURN TO TOP OF THE PAGE](#)

Notational Descriptions

The following subsections describe notational conventions used in this document.

Notes, Cautions and Warnings

Throughout this guide blocks of text may be accompanied by an icon and printed in bold or italic type. These blocks contain notes, cautions or warnings. They are used as follows:



NOTE: This icon indicates important information and tips that help you make better use of your computer system.



CAUTION: This icon indicates information that tells you how to avoid either potential damage to hardware or loss of data.



WARNING: This icon indicates the potential for bodily harm and tells you how to avoid the problem.

Some warnings may appear in alternate formats and may not be accompanied by an icon. In such cases, the specific presentation of the warning is mandated by the relevant regulatory authority.

[RETURN TO TOP OF THE PAGE](#)

©2001 Koninklijke Philips Electronics N.V.

All rights reserved. Reproduction, copying, use, modification, hiring, renting, public performance, transmission and/or broadcasting in whole or in part is prohibited without written consent of Philips Electronics N.V.

Product Information

[Product Features](#) • [Technical Specifications](#) • [Resolution & Preset Modes](#) • [Philips Pixel Defect Policy](#) • [Automatic Power Saving](#) • [Physical Specification](#) • [Pin Assignment](#) • [Product Views](#) • [Physical Function](#)

Product Features

150MT

- Multi video input allowing display of PC, DVD, VCD, VCR and TV
- Picture in Picture (PIP) function
- Super-high brightness and fast response time
- AUTO adjustment optimizes picture quality
- 100-page Teletext (in areas where teletext service is available)

[RETURN TO TOP OF THE PAGE](#)

Technical Specifications*

LCD PANEL

• Type	TFT LCD
• Screen size	15" visual
• Pixel Pitch	0.297 x 0.297mm (15.0")
• LCD Panel type	1024 x 768 pixels R.G.B. vertical stripe Anti-glare polarizer
• Effective viewing area	304.1 x 228.1mm (15.0")
• Display Colors	8 bits interface (16.7M colors)

SCANNING

• Vertical refresh rate	56Hz-75Hz
• Horizontal frequency	30kHz-61kHz

VIDEO

• Video dot rate	80 MHz
------------------	--------

• Input impedance	
- Video	75 ohm
- Sync	2K ohm
• Input signal levels	0.7 Vpp
• Sync input signal	Separate sync Composite sync
• Sync polarities	Positive and negative
• Input Frequency	XGA Hsync 48- 61 kHz, Vsync 60 - 75 Hz (N.I.) SVGA Hsync 35- 50 kHz, Vsync 56 - 75 Hz (N.I.) VGA Hsync 31- 38 kHz, Vsync 60 - 75 Hz (N.I.)
• Video interface	D-sub, S-Video, TV-RF, SCART (Europe) or composite and components video (others)

AUDIO

• Input level for PC/SVHS/SCART	500 mV nominal
• Headphone out signal level	4mW max.
• Loudspeaker	5W Stereo Audio (2.5W/channel RMS x2, 200Hz~10kHz, 4 ohm, 10% THD)

OPTICAL CHARACTERISTICS

• Contrast ratio	500:1 (typ.)
• Brightness	310 cd/m ² (typ.)
• Peak contrast angle	6 o'clock
• White Chromacity	x: 0.281 y: 0.311 (at 9300° K) x: 0.312 y: 0.338 (at 6500° K)
• Viewing Angle (C/R >5)	Upper ≥55° (typ.) Lower ≥65° (typ.) Left ≥70 ° (typ.) Right ≥70 ° (typ.)
• Response time	≤25ms (typ.)

* This data is subject to change without notice.

[RETURN TO TOP OF THE PAGE](#)

Resolution & Preset Modes

- Maximum 1024 x 768 at 75Hz
- Recommended 1024 x 768 at 60Hz

14 user definable modes

14 factory preset modes:

H. freq (kHz)	Resolution	V. freq (Hz)
31.469	640*350	70.086
31.469	720*400	70.087
31.469	640*480	59.940
35.000	640*480	67.000
37.861	640*480	72.809
37.500	640*480	75.000
35.156	800*600	56.250
37.879	800*600	60.317
48.077	800*600	72.188
46.875	800*600	75.000
49.700	832*624	75.000
48.363	1024*768	60.004
56.476	1024*768	70.069
60.023	1024*768	75.029

[RETURN TO TOP OF THE PAGE](#)

Automatic Power Saving

If you have VESA DPMS compliance display card or software installed in your PC, the monitor can automatically reduce its power consumption when not in use. If an input from a keyboard, mouse or other input device is detected, the monitor will then 'wake up' automatically. The following table shows the power consumption and signaling of this automatic power saving feature:

Power Management Definition

VESA Mode	Video	H-sync	V-sync	Power Used	LED color
ON	Active	Yes	Yes	48W (typ.)	Green
OFF	Blanked	No	No	< 2W	Flashing Green

This monitor is ENERGY STAR® compliant. As an ENERGY STAR® Partner, PHILIPS has determined that this product meets the ENERGY STAR® guidelines for energy efficiency.

[RETURN TO TOP OF THE PAGE](#)

Physical Specifications

• Dimension (WxHxD)	391 x 366 x 200 mm (incl. Pedestal)
• Weight	5.63 kg
• Tilt (Forward / Backward)	- 5° / 30°
• Power supply	100 — 240 VAC, 50/60 Hz
• Power consumption	48 W (typ.)
• Temperature (operating)	5° C to 35° C
• Relative humidity	20% to 80%
• System MTBF	50K hrs (CCFL 40Khrs)

* This data is subject to change without notice.

[RETURN TO TOP OF THE PAGE](#)

Pin Assignment

The 15-pin D-sub connector (male) of the signal cable:

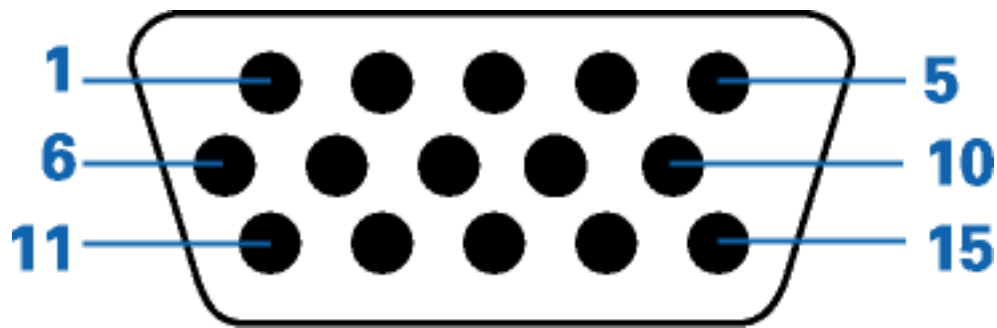

Pin No.	Assignment		Pin No.	Assignment
1	Red video input		9	DDC +5V
2	Green video input		10	Logic ground
3	Blue video input		11	Identical output - connected to pin 10
4	Identical output - connected to pin 10		12	Serial data line (SDA)
5	Ground		13	H. Sync / H+V
6	Red video ground		14	V. Sync
7	Green video ground		15	Data clock line (SCL)
8	Blue video ground			

[RETURN TO TOP OF THE PAGE](#)

Product Views

Follow the links to see various views of the monitor and its components.

[Front View Product Description](#)

[RETURN TO TOP OF THE PAGE](#)

Physical Function

Tilt

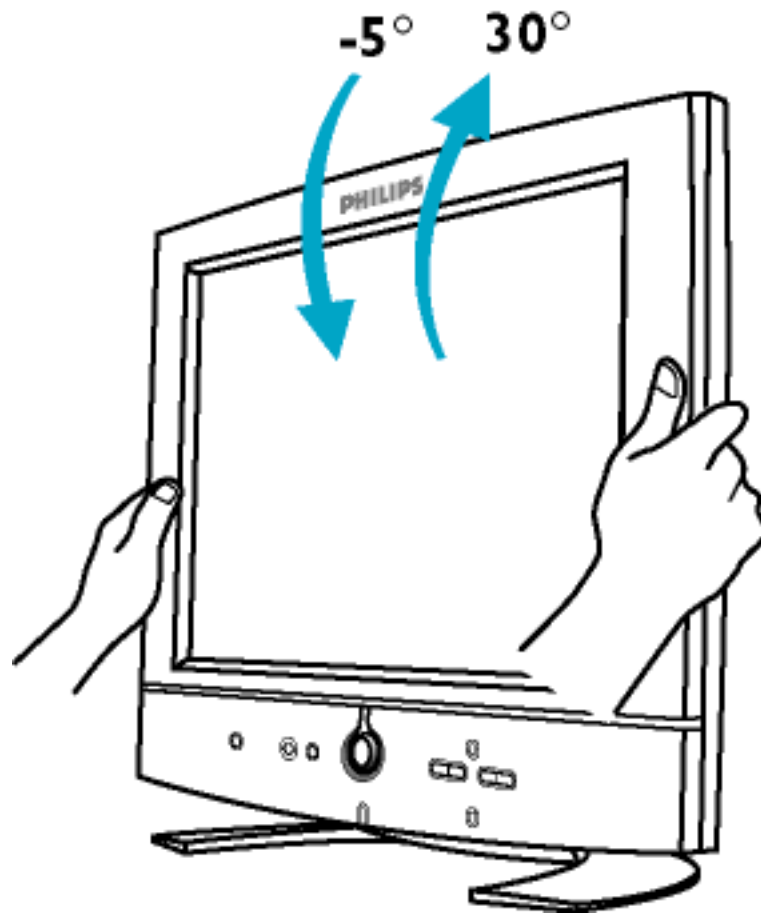



[RETURN TO TOP OF THE PAGE](#)

Installing your LCD Monitor/TV

[Front View Product Description](#) • [Connecting to Your PC, TV antenna, DVD/VCR etc.](#) • [Removing and Re-installing the Base](#) • [Basic Monitor TV Connections](#) • [Getting Started](#) • [Optimising Performance](#)

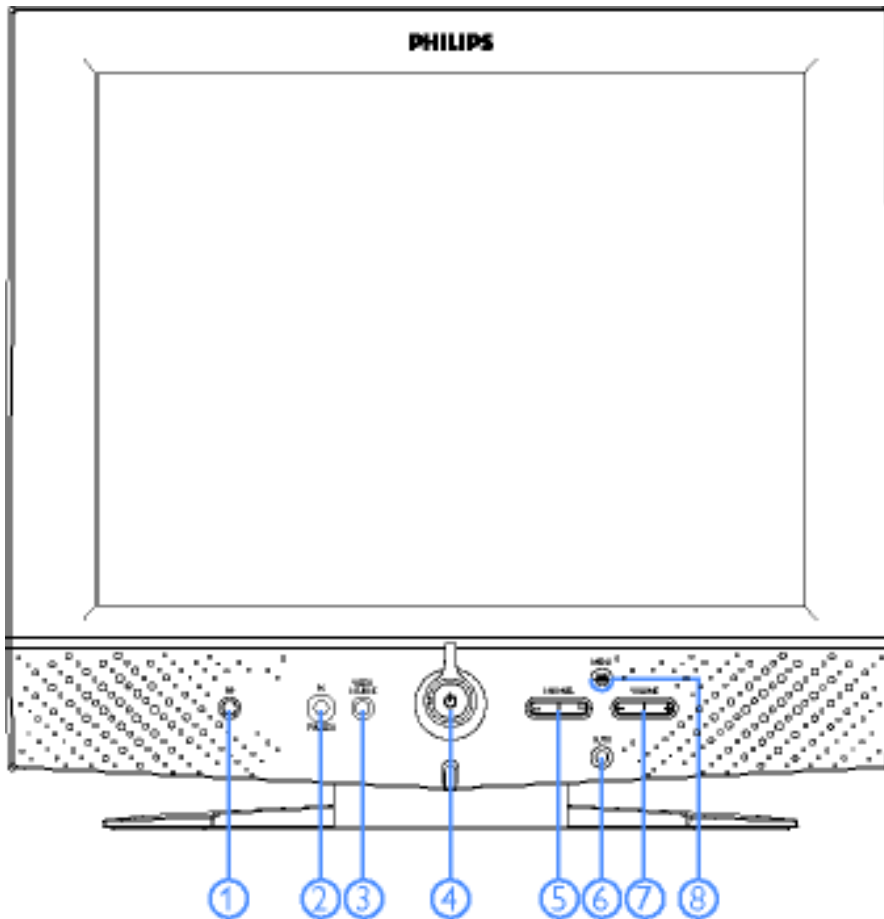
Front View Product Description



- | | | |
|---|---|---|
| 1 | PIP | Activate PIP (Picture in Picture) window and select size |
| 2 | PC<->TV/Video | Switch the monitor from PC mode to TV/Video mode and vice versa |
| 3 | VIDEO SOURCE | TV/Video source selection |
| 4 |  | Power switch On/Off |
| 5 |  | Increase or decrease the channel number or up or down the highlighted function in OSD |

- | | | |
|---|----------------|---|
| 6 | AUTO | Automatically adjust the H/V position, phase and clock setting |
| 7 | + - | Increase or decrease the level of audio volume
or
move up or down the highlighted function in OSD |
| 8 | MENU OK | Open the OSD and select the highlighted function |

[RETURN TO TOP OF THE PAGE](#)

Side View

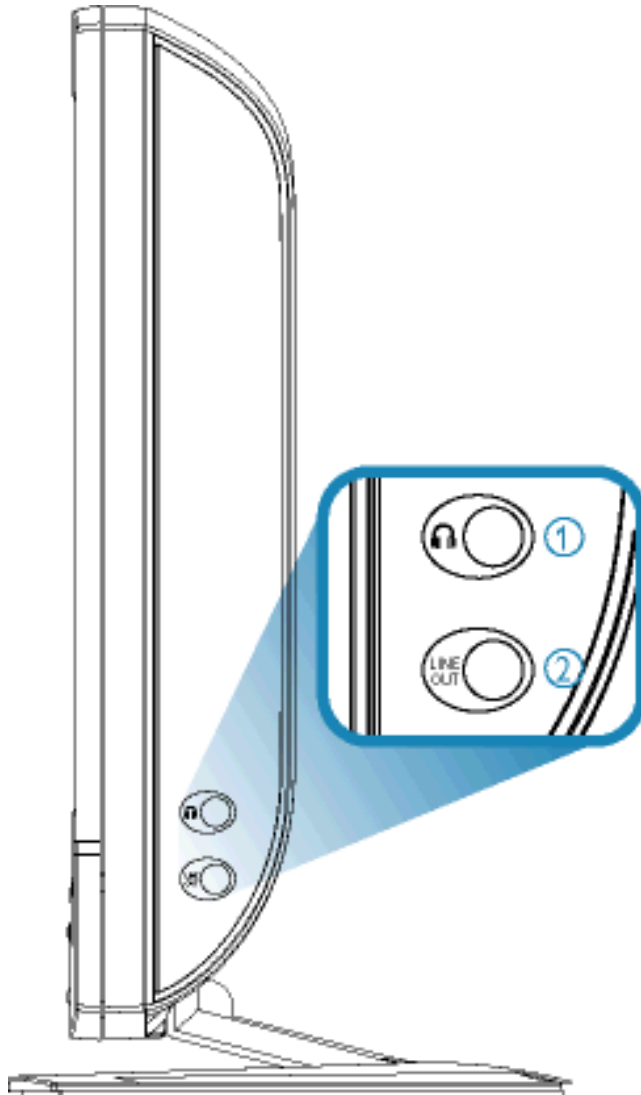

1. Headphone Jack
2. LINE OUT Jack

Rear View

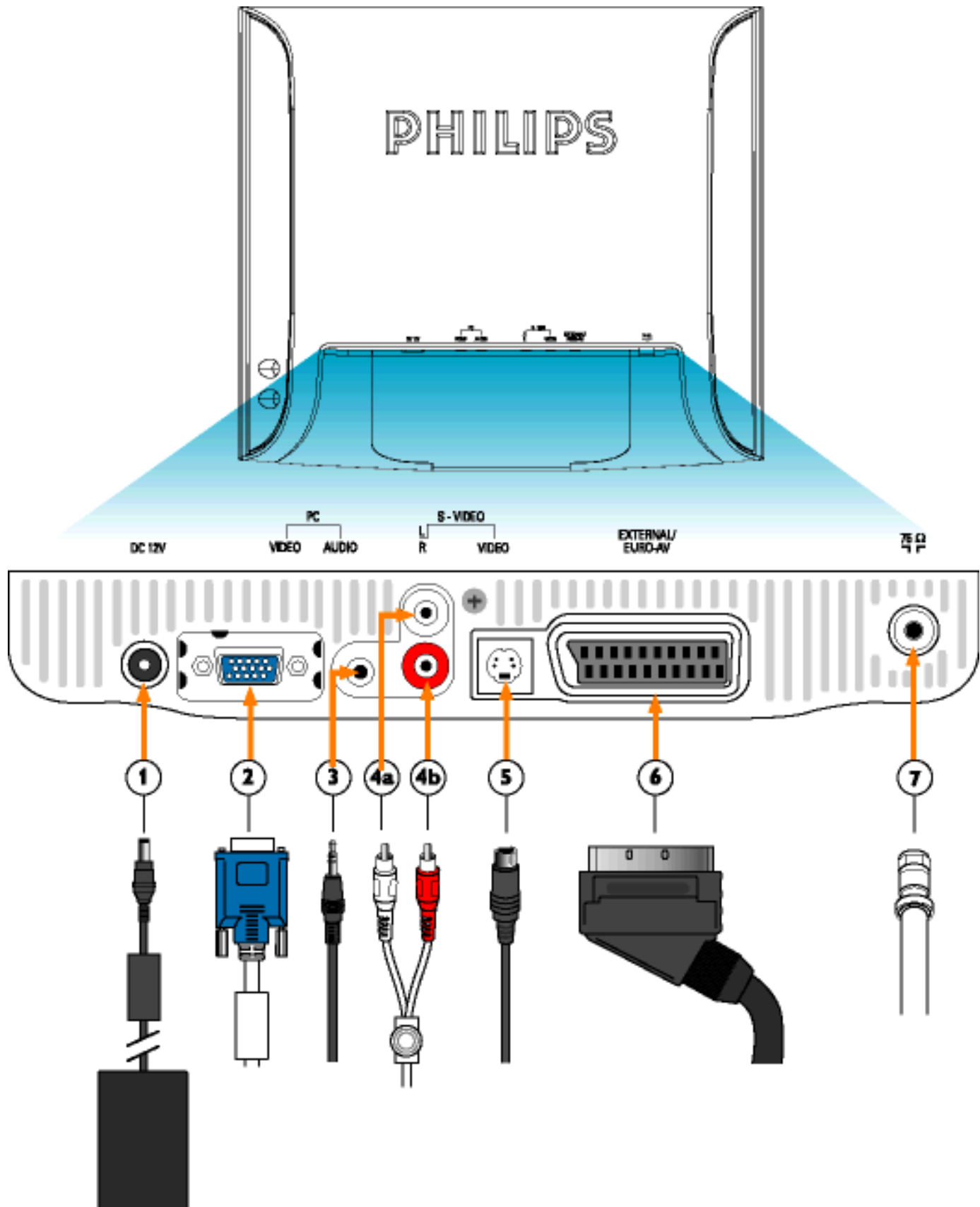



(Europe)

1	DC 12V	DC 12V power in
2	PC - Video	D-Sub input
3	PC - Audio	PC Stereo input
4	S-VIDEO (L)	AV audio (L)
	S-VIDEO (R)	AV audio (R)
5	S-VIDEO	S-VIDEO in
6	EXTERNAL/ EURO-AV	SCART connection (for Europe only)
7	75 	TV Antenna or CATV cable in

[RETURN TO TOP OF THE PAGE](#)

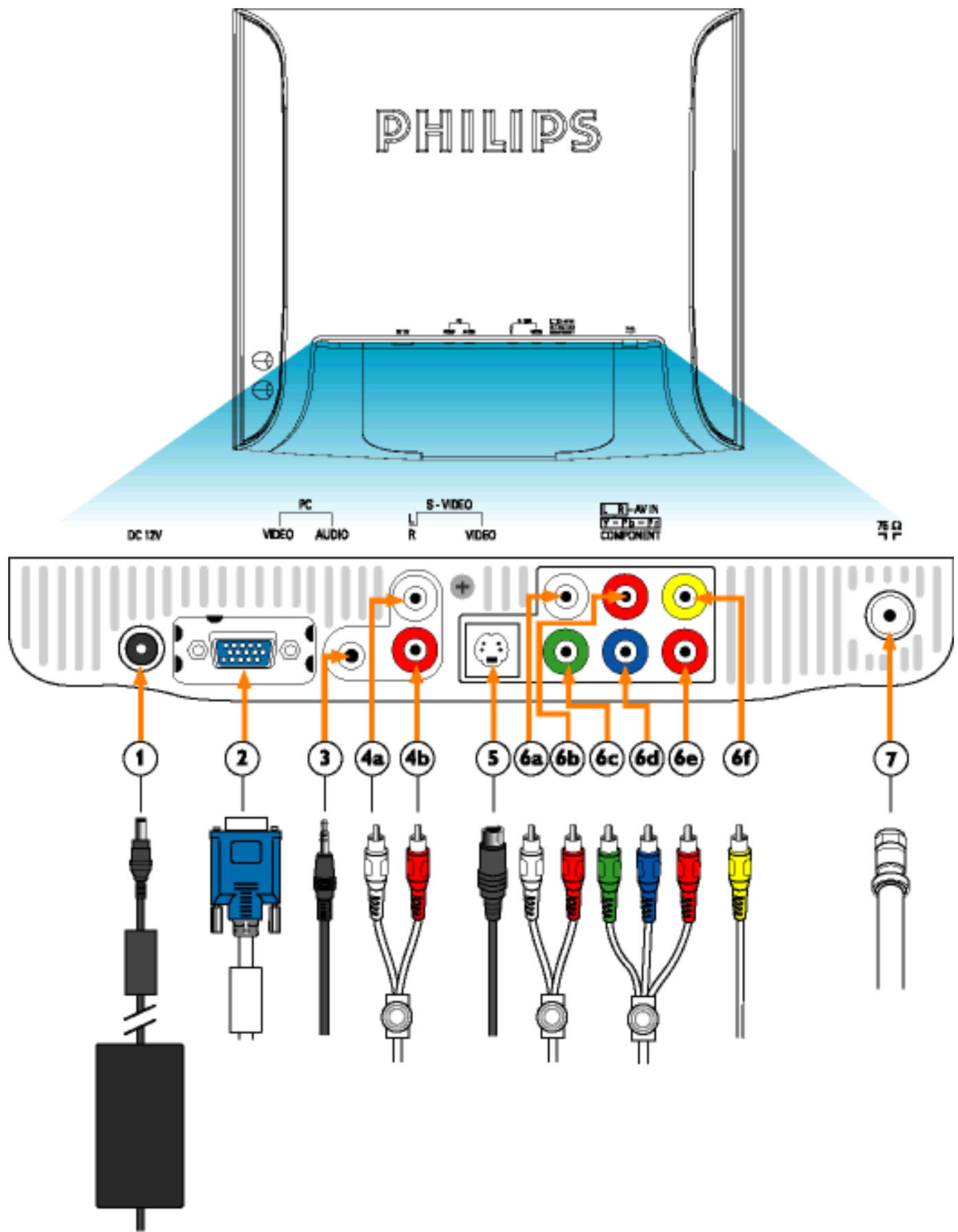

(North America and Asia Pacific)

1	DC 12V	DC 12V power in
2	PC - Video	D-Sub input
3	PC - Audio	PC Stereo input
4	S-VIDEO (L)	AV audio (L)
	S-VIDEO (R)	AV audio (R)
5	S-VIDEO	S-VIDEO in
6	L R - AV IN	6a Audio (L) in
	Y-Pb-Pr	6b Audio (R) in
	Component	6f CVBS in
		6c, d, e Component video in
7	75 Ω	TV Antenna or CATV cable in

[RETURN TO TOP OF THE PAGE](#)

Optimizing Performance

- For best performance, ensure that your display settings are set at 1024x768@60Hz (for 15") or 1280x1024, 60Hz (for 18").



Note: You can check the current display settings by pressing the 'OK' button once. Go into the Product Information. The current display mode is shown on the item called RESOLUTION.

- You can also install the [Flat Panel Adjust \(FP Adjust\) program](#), a program for getting the best performance out of your monitor. This is included on this CD. Step-by-step instructions are provided to guide you through the installation process. Click on the link to find out more about this program.

More about



[FP_setup03.exe](#)

[RETURN TO TOP OF THE PAGE](#)

On-Screen Display

[Description of the On-Screen Display](#) • [The OSD Tree](#)

Description of the On Screen Display

What is the On-Screen Display?

This is a feature offered by all Philips LCD monitors/TVs. It allows an end user to adjust screen performance of monitors directly through an on-screen instruction window. The user interface provides user-friendliness and ease-of-use when the user is operating the monitor.

Basic and simple instruction on the control keys.

When you press the **MENU** button on the front control of your monitor, the On-Screen Display (OSD) Main Controls window will pop up and you can then start making adjustments to your monitor's various features. Use the **+** **-** or the **▲** **▼** keys to make your adjustments.

- In PC Mode



- In TV/Video Mode

[Europe](#) • [Asia Pacific](#) • [NTSC](#)



[RETURN TO TOP OF THE PAGE](#)

The OSD Tree

Below is an overall view of the structure of the On-Screen Display. You can use this as a reference when you want to work your way around the different adjustments later on.

- In PC Mode:

First Level

Second Level

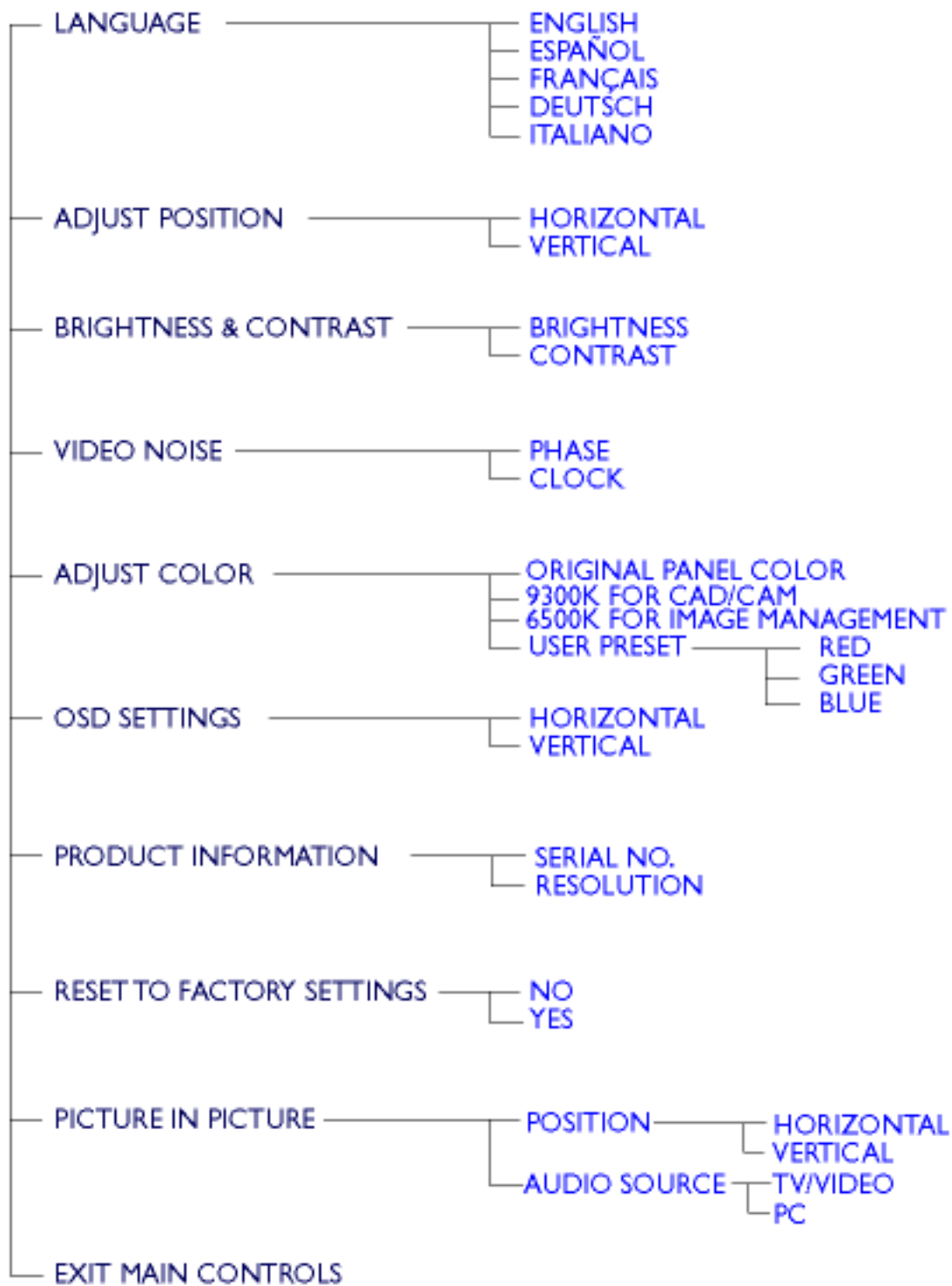

* Specifications are subject to change without prior notice.

[RETURN TO TOP OF THE PAGE](#)

- In TV/Video Mode:

(For Europe)

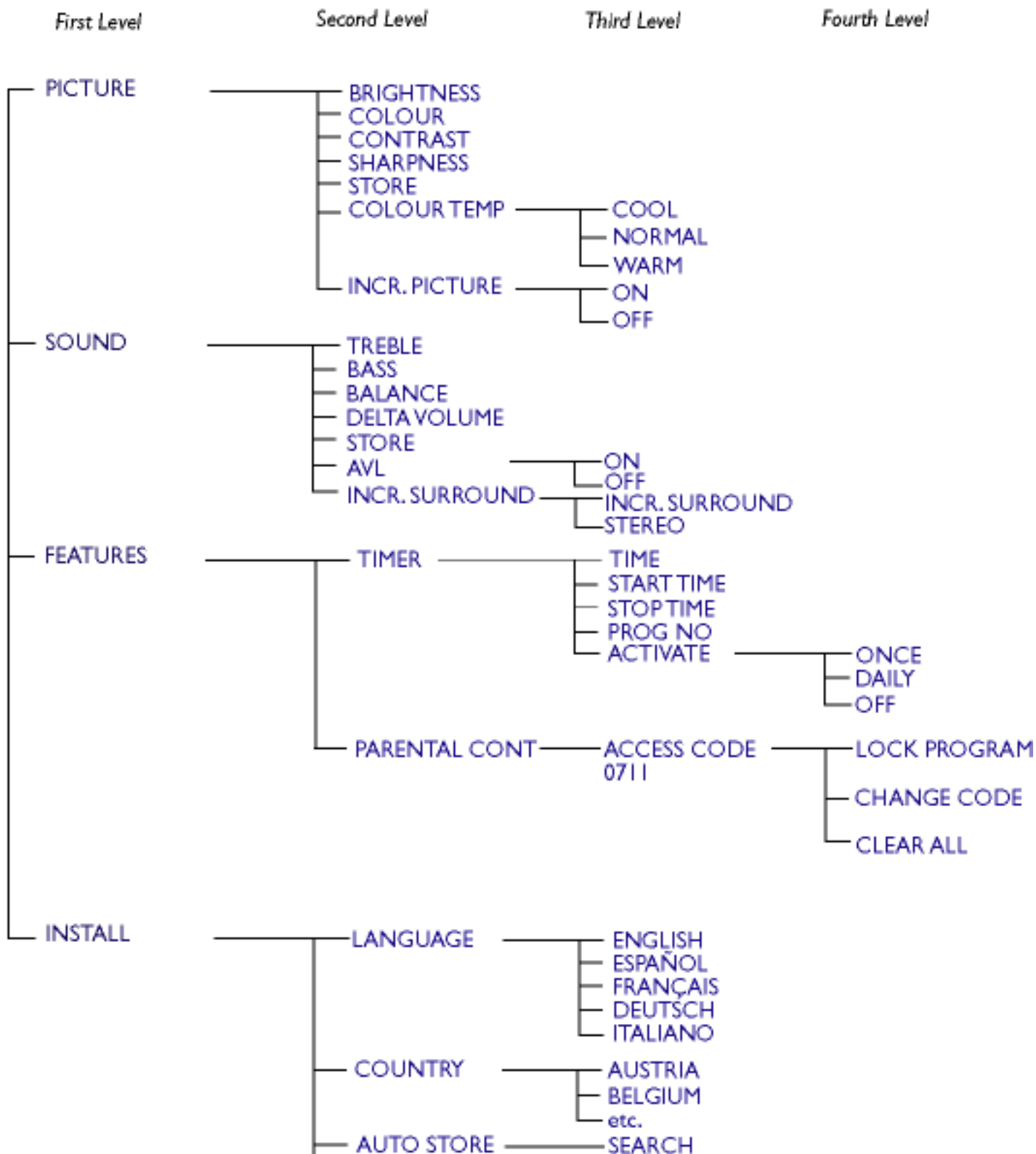

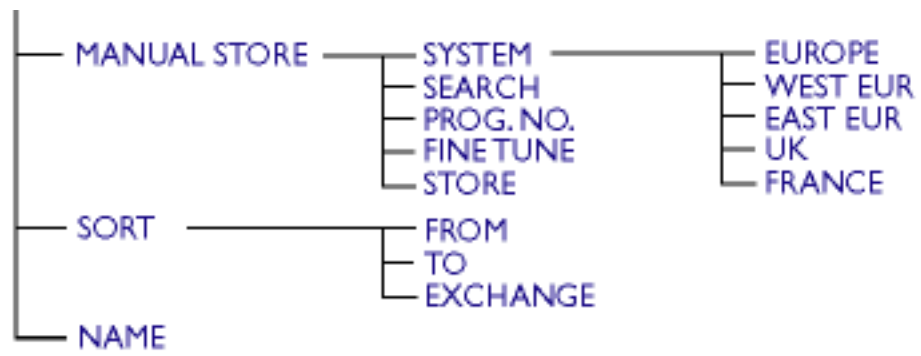

• Specifications are subject to change without prior notice.

[RETURN TO TOP OF THE PAGE](#)

(For Asia Pacific)

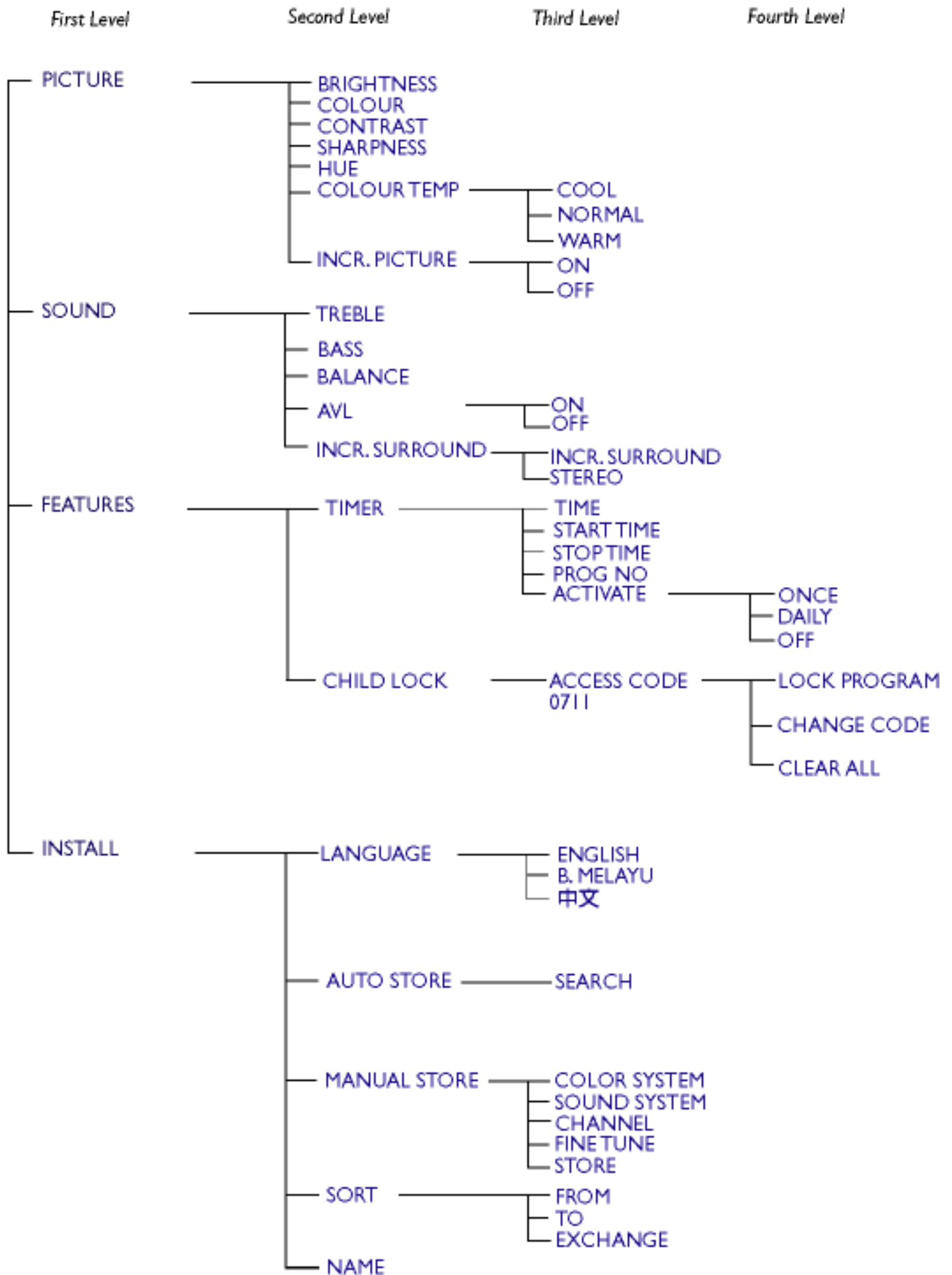

• Specifications are subject to change without prior notice.

[RETURN TO TOP OF THE PAGE](#)

(For NTSC system: North America, Philippine, Taiwan and Korea)

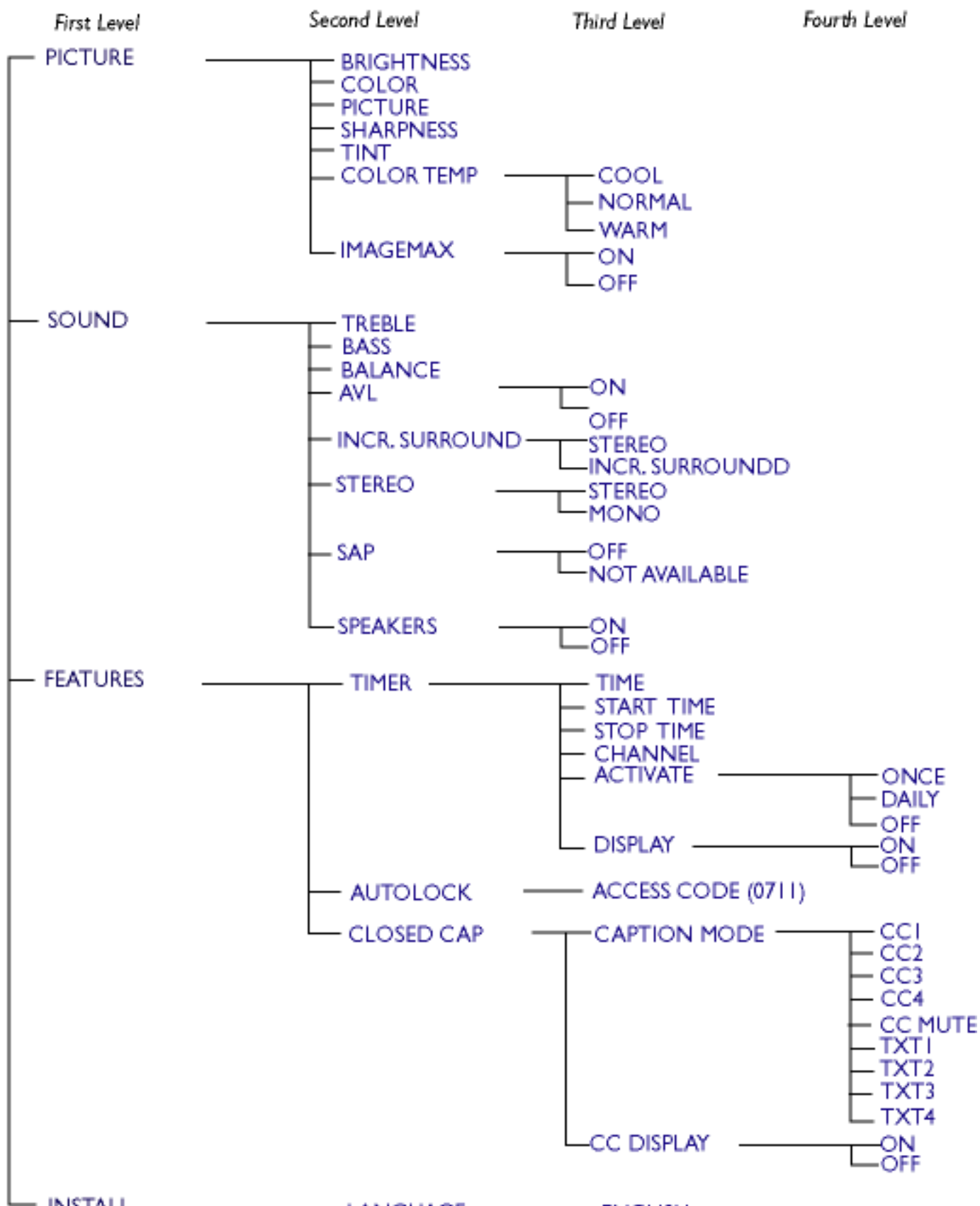

INSTALL

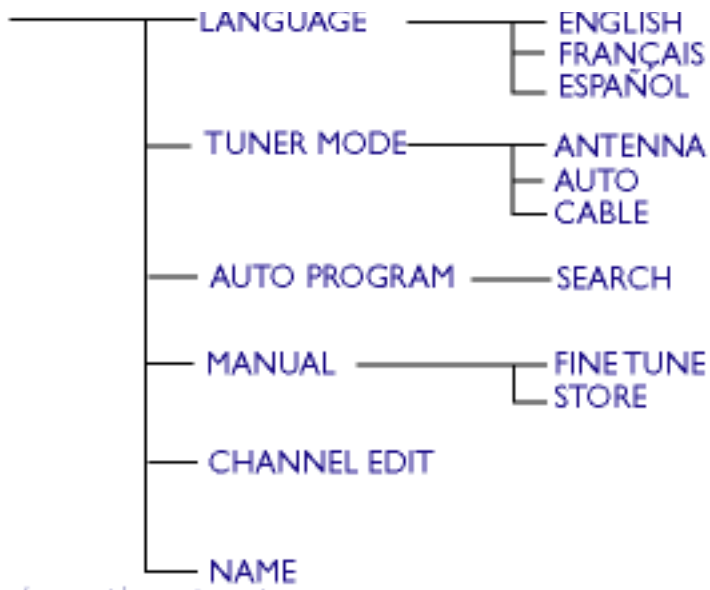

* Specifications are subject to change without prior notice.

[RETURN TO TOP OF THE PAGE](#)

TV Control



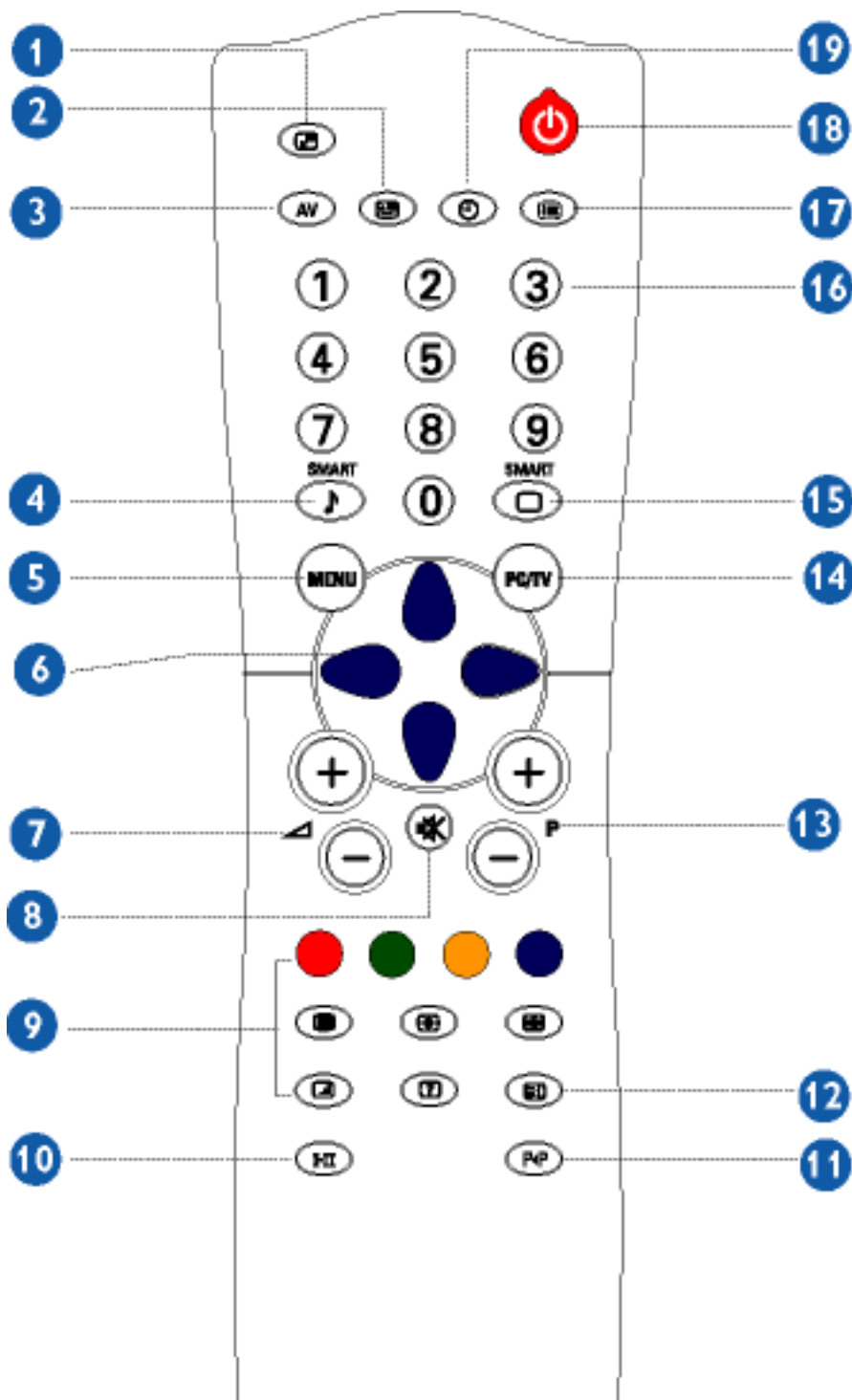

[Using your Remote Control](#) • [Using the Teletext](#) • [Using the Programme Listing](#) • [Using Other Menu: PAL System - Europe](#) • [PAL System - Asia](#) • [NTSC System](#)

Using your Remote Control

(For PAL system: Europe and Asia Pacific)





1	PIP On/Off, Size	To activate or close the 'Picture in Picture' function in PC mode and to enlarge or reduce the PIP window size using the same button
2	PIP Shift	To change 'Picture in Picture' window position in PC mode
3	AV source	<ul style="list-style-type: none"> ● To select TV/Video sources ● If using TV 'STANDBY', press this button to return to 'ON'
4	Smart sound controls	To access a series of settings: VOICE, MUSIC, THEATRE and PERSONAL
5	Menu	To turn on or off the OSD (On-Screen Display) To return to last item in OSD & clear menu from screen
6	Cursor	<p>To move the cursor up /down/right/left to scroll through a list of options</p> <ul style="list-style-type: none"> ● Cursor right  To access the sub-menus and adjust the settings with cursor left  ● Cursor down  To select the next item on the menu, and return to the last item with cursor up 
7	Volume	To adjust the sound level
8	Mute	To disable sound. To restore sound, press button again.
9	<u>Teletext features</u>	Available in PAL system areas



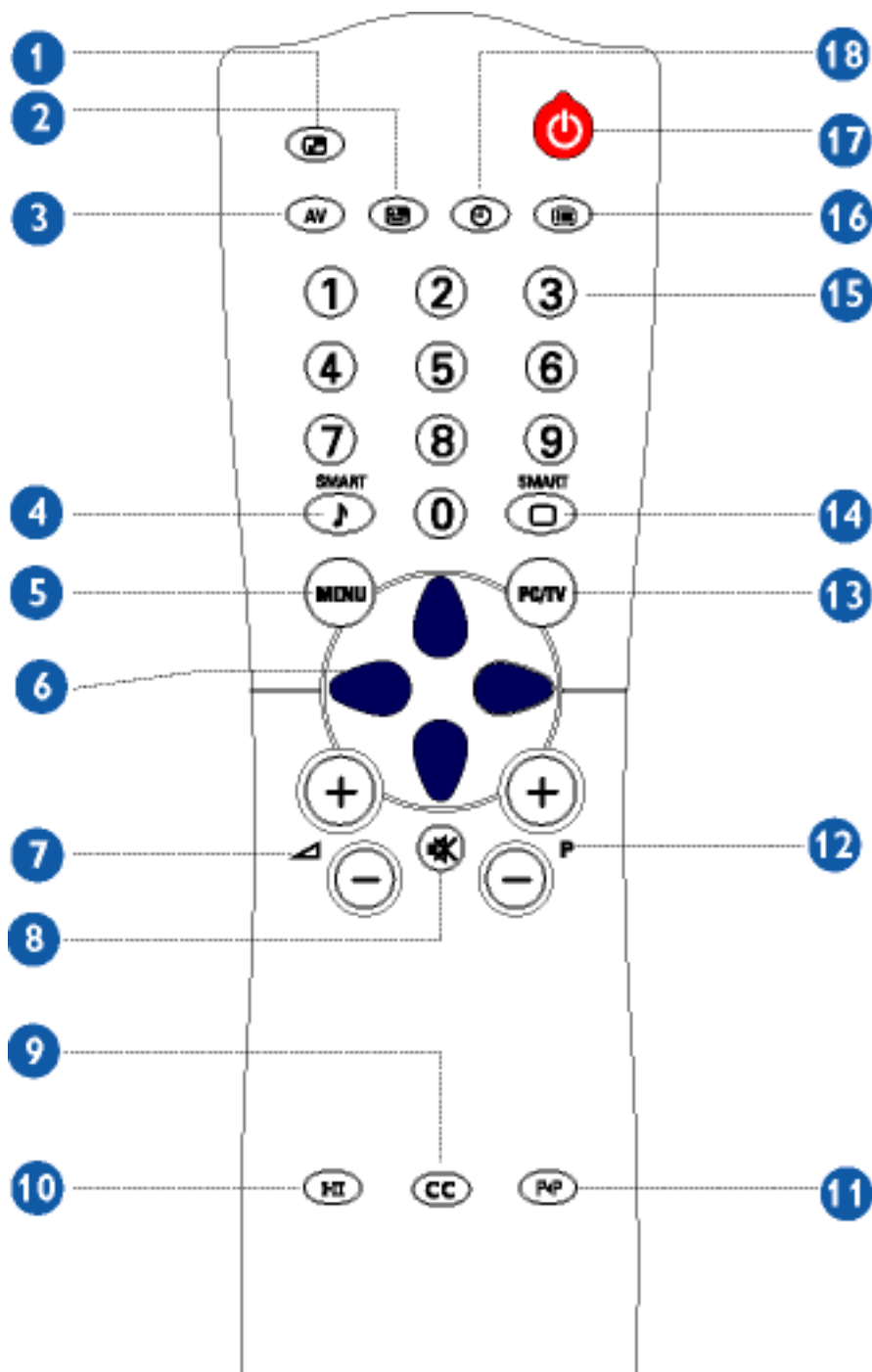

10	Sound mode	<ul style="list-style-type: none"> ● To switch from STEREO to MONO or to choose between Dual I and Dual II for bilingual transmissions. For TV sets fitted with NICAM reception, depending on the transmission, you can switch from NICAM STEREO to MONO or choose between NICAM DUAL I, NICAM DUAL II and MONO. ● If using Teletext, press this button to display dual pages on screen.
11	Previous programme	To access the last programme viewed.
12	Screen information	<p>To display/clear the programme number, the name (if it exists), the time, the sound mode and the time remaining on the timer.</p> <p>Hold down for 5 seconds to permanently display the programme number on the screen.</p> <p>The volume level and the smart control adjustments are then displayed each time they are used.</p>
13	Selecting TV programmes	<p>To move up or down a programme.</p> <p>The number, (the name) and the sound mode are displayed for a few seconds.</p> <p>For some TV programmes the title of the programme appears at the bottom of the screen.</p>
14	PC/TV mode selection	To select TV or PC mode
15	Smart picture controls	To select your desired picture setting from 5 picture settings: RICH, NATURAL, SOFT, MULTIMEDIA and PERSONAL.
16	Numerical keys	<ul style="list-style-type: none"> ● For direct access to programmes For a 2-digit programme number, the 2nd digit must be entered before the dash disappears. ● If using TV 'STANDBY', press any of number keys to return to 'ON'
17	Programme List	To navigate through a list of installed programmes to obtain a quick overview of the programmes & activate the programmes you have selected.

18	Standby	To set the TV temporarily to standby mode. To switch on the TV set, press Programme button (p -, +), any digit between 0 and 9 or AV source button (The green light indicator flickers when set is in standby mode)
19	Sleep timer	To select the period of time after which the set will switch automatically to standby mode (up to 240 minutes)

(For NTSC system: North America, Philippine, Taiwan and Korea)





1	PIP On/Off, Size	To activate or close 'Picture in Picture' function in PC mode and to enlarge or reduce the PIP window size using the same button
2	PIP Shift	To change 'Picture in Picture' window position in PC mode
3	AV source	To select TV/Video sources
4	Smart sound controls	To access a series of settings: VOICE, MUSIC, THEATRE and PERSONAL
5	Menu	To turn on or off the OSD (On-Screen Display) To return to last item in OSD & clear menu from screen
6	Cursor	To move the cursor up /down/right/left to scroll through a list of options <ul style="list-style-type: none"> ● Cursor right  To access the sub-menus and adjust the settings with cursor left  ● Cursor down  To select the next item on the menu, and return to last item with cursor up 
7	Volume	To adjust the sound level
8	Mute	To disable sound. To restore sound, press button again.
9	Closed Caption	To disable or enable closed caption function
10	Sound mode	To choose MONO, STEREO and SAP (2 nd audio programme) Sound system
11	Previous programme	To access the last channel viewed.







12	Selecting TV programmes	To move up or down a programme. The number, (the name) and the sound mode are displayed for a few seconds. For some TV programmes the title of the programme appears at the bottom of the screen.
13	PC/TV mode selection	To select TV or PC mode on and switch
14	Smart picture controls	To select your desired picture setting from 5 settings: MOVIES, SPORTS, WEAK SIGNAL, MULTIMEDIA and PERSONAL.
15	Numerical keys	For direct access to channel. For a 2-digit channel number, the 2 nd digit must be entered before the dash disappears.
16	Programme List	To navigate through a list of installed programmes to gain a quick overview of the programmes & activate the programmes you have selected.
17	Standby	To set the TV temporarily to STANDBY mode. Press the button again to return to ON. (The green light indicator flickers when set is in standby mode)
18	Sleep timer	To select the period of time after which the set will automatically switch to standby mode (up to 240 minutes)

[RETURN TO TOP OF THE PAGE](#)

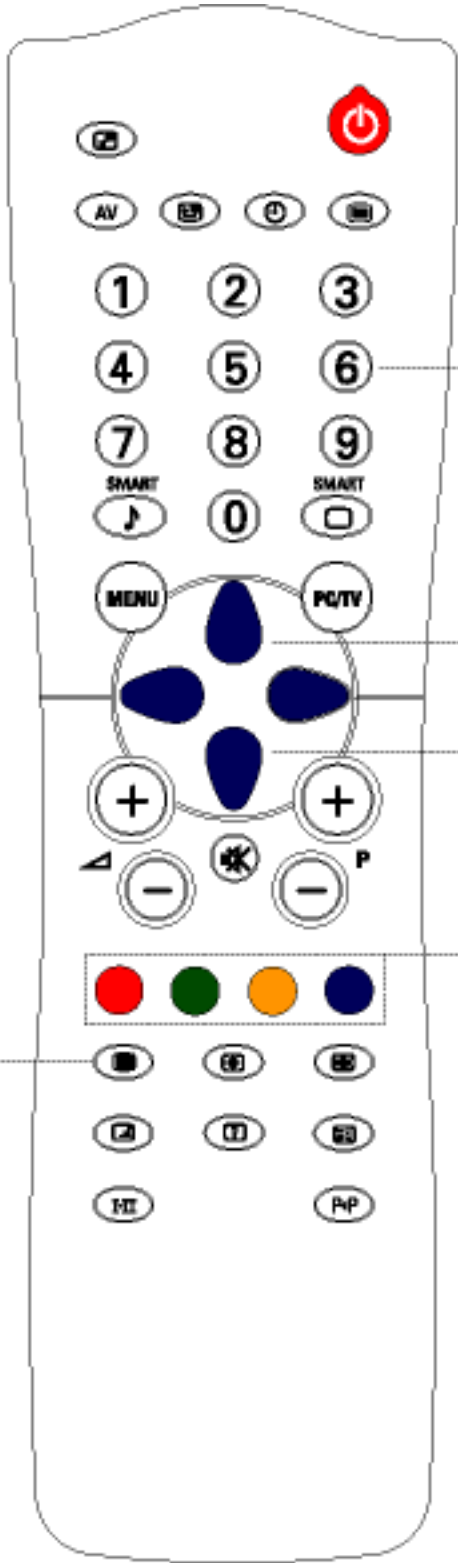
Using the Teletext (for areas where teletext service is available)

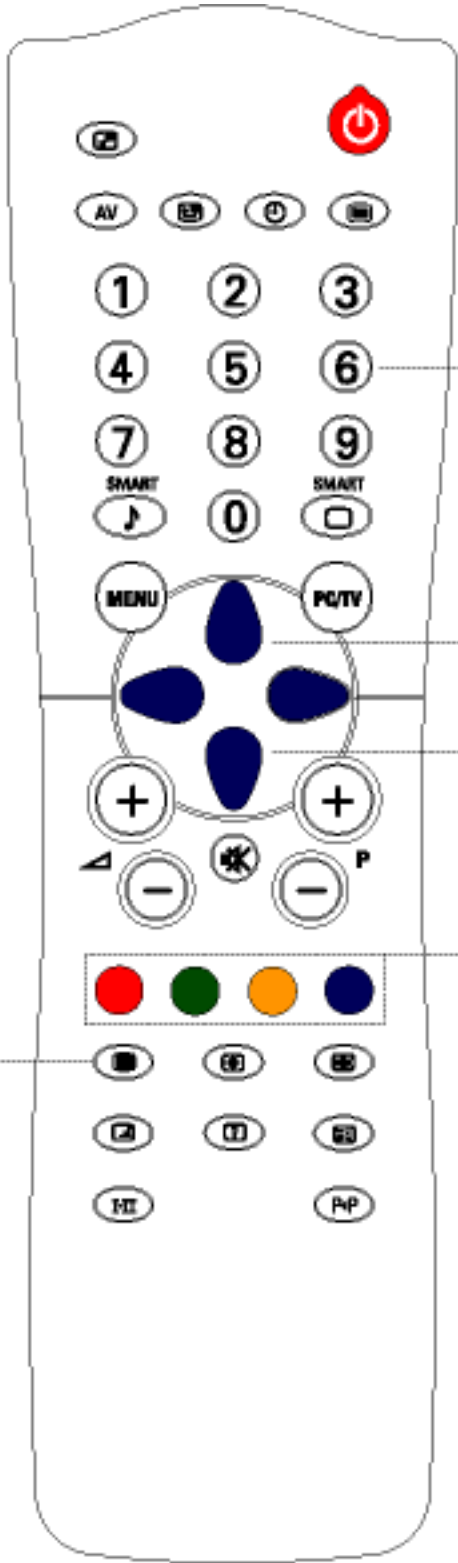
Teletext is an information system broadcast by certain TV channels. It can be consulted in the same way as a newspaper. It also provides subtitles for the hard of hearing or people who are unfamiliar with the broadcast language (cable TV network, satellite channels, etc.).

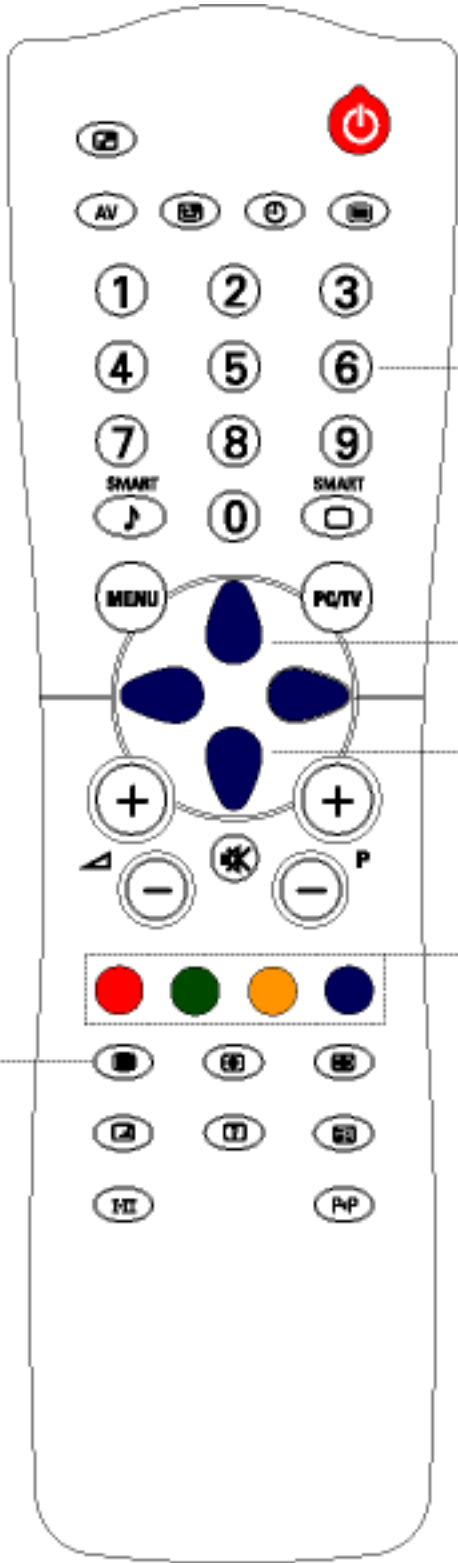
	Press button	Result on Screen





	<p>1</p> <p>On/Off Teletext</p> 	<p>Display or exit Teletext. The main index page presents a list of subjects to which you have access. Each subject has a corresponding page number (always 3 digits). Note: If selected TV channel does not broadcast Teletext, P100 is displayed and the screen remains black. Exit Teletext mode and choose another TV channel.</p>
	<p>2</p> <p>Selecting a Teletext page</p> 	<p>Key in the required Teletext page (3 digits). The page number is displayed in the top left-hand corner of the screen. When the Teletext page is located, the counter stops searching. If the counter keeps searching, it means that the page is not available for selection. If you make a mistake when keying in the page number, you have to finish keying in the 3-digit number before re-keying the correct page number.</p>
	<p>3</p> <p>Accessing a Teletext page</p> 	<p>Press the CURSOR UP button to display the previous page and the CURSOR DOWN button to display the next page.</p>



4 **Direct Access
to an item or
corresponding
pages**



The 4-colour buttons allow you to access directly an item or corresponding pages.

[RETURN TO TOP OF THE PAGE](#)

		Press button	Result on Screen
	5	Mix 	Allows you to superimpose the Teletext page over the TV programme. Press the button a second time to return to Teletext page only.
	6	Reveal/Conceal 	Press the button once to reveal hidden information (solutions to puzzles, riddles, etc.). Press the button a second time to conceal information.
	7	Dual pages 	Once the Teletext function activated, press the 'Dual Pages' button once to display two pages on screen. Press the button again to one-page screen.
	8	Enlarge 	Press the button once to enlarge and view the top half of the page. Press the button a second time to enlarge and view the bottom half of the page. Press the button a third time to return to normal size page.

	9	Hold 	<p>In 'Dual pages' mode, the HOLD button enables you to hold a page on one side and activate the page on the other side which can be scrolled to more pages by pressing the cursor down or up. To switch the holding status to the page on the other side, press the HOLD button again.</p>
	10	Main Index 	<p>Press the button to return to the main index (generally on page 100).</p>

[RETURN TO TOP OF THE PAGE](#)

Using the Programme Listing

The programme listing feature allows you to navigate through a list of installed programmes to gain a quick overview of the channels installed on your television.

		Press button	Result on Screen
--	--	--------------	------------------

		<p>1. Display the list of installed pro-grammes. The current channel is highlighted.</p>	
		<p>2. Run through the programme list and highlight the channel number you want to view.</p>	
		<p>3. Activate the channel you have selected.</p>	
		<p>4. Exit menu from screen or wait for the menu to time out and disappear from screen.</p>	

[RETURN TO TOP OF THE PAGE](#)

Customer Care & Warranty

PLEASE SELECT YOUR COUNTRY/AREA TO REVIEW DETAILS OF YOUR WARRANTY COVERAGE

WESTERN EUROPE: [Austria](#) • [Belgium](#) • [Cyprus](#) • [Denmark](#) • [France](#) • [Germany](#) • [Greece](#) • [Finland](#) • [Ireland](#) • [Italy](#) • [Luxembourg](#) • [the Netherlands](#) • [Norway](#) • [Portugal](#) • [Sweden](#) • [Switzerland](#) • [Spain](#) • [United Kingdom](#)

EASTERN EUROPE: [Czech Republic](#) • [Hungary](#) • [Poland](#) • [Russia](#) • [Turkey](#)

LATIN AMERICA: [Antilles](#) • [Argentina](#) • [Brasil](#) • [Chile](#) • [Colombia](#) • [Mexico](#) • [Paraguay](#) • [Peru](#) • [Uruguay](#) • [Venezuela](#)

NORTH AMERICA: [Canada](#) • [USA](#)

PACIFIC: [Australia](#) • [New Zealand](#)

ASIA: [Bangladesh](#) • [China](#) • [Hong Kong](#) • [India](#) • [Indonesia](#) • [Japan](#) • [Korea](#) • [Malaysia](#) • [Pakistan](#) • [Philippines](#) • [Singapore](#) • [Taiwan](#) • [Thailand](#)

AFRICA: [Morocco](#) • [South Africa](#)

MIDDLE EAST: [Dubai](#) • [Egypt](#)

Download and Print

[Installing your LCD monitor driver](#) • [Download and Printing Instructions](#) • [Installing FPadjust Program](#)

Installing Your LCD monitor driver

System requirements:

- PC running Windows 95, Windows 98, Windows 2000 , Windows Me, Windows XP or later
- Find your driver ".inf/.icm/.cat" at : /PC/drivers/

Read the "Driver_install02.txt" file before installing.

This page provides an option to read the manual in .pdf format. PDF files can be downloaded into your hard disk, then viewed and printed with Acrobat Reader or through your browser.

If you do not have Adobe® Acrobat Reader installed, click on the link to install the application. [Adobe® Acrobat Reader for PC](#) / [Adobe® Acrobat Reader for Mac](#).

Download instructions:

To download the file:

1. Click-and-hold your mouse over the icon below. (Win95/98/2000/Me/XP users right-click)

Download  [150MT.pdf](#)

Download  [150MT2.pdf](#)

Download  [180MT.pdf](#)

2. From the menu that appears, choose 'Save Link As...', 'Save Target As...' or 'Download Link to Disk'.
3. Choose where you would like to save the file; click 'Save' (if prompted to save as either 'text' or 'source', choose 'source').

Printing instructions:

To print the manual:

1. With the manual file open, follow your printer's instructions and print the pages you need.

[RETURN TO TOP OF THE PAGE](#)

Installing FPadjust Program

The FP Adjust program generates alignment patterns which will help you adjust monitor settings such as CONTRAST, BRIGHTNESS, HORIZONTAL & VERTICAL POSITION, PHASE and CLOCK.

System requirements:

- PC running Windows 95, Windows 98, Windows 2000, Windows Me, Windows XP or later

To install FPadjust Program:

- Click on the link or icon to install FPadjustment Program.
- or
- Click-and-hold your mouse over the icon. (Win95/98/2000/Me/XP users right-click)

Download



[FP_setup03.exe](#)

- From the menu that appears, choose 'Save Link As...', 'Save Target As...' or 'Download Link to Disk'.
- Choose where you would like to save the file; click 'Save' (if prompted to save as either 'text' or 'source', choose 'source').
- Exit your browser and install the FPadjust Program.

Read the "FP_Readme03.txt" file before installing.

[RETURN TO TOP OF THE PAGE](#)

FAQs (Frequently Asked Questions)

[Safety and Troubleshooting](#) • [General FAQs](#) • [Screen Adjustments](#) • [Compatibility with Other Peripherals](#) • [LCD Panel Technology](#) • [Ergonomics, Ecology and Safety Standards](#) • [Troubleshooting](#) • [Regulatory Information](#) • [Other Related Information](#)

General FAQs

Q: When I install my monitor what should I do if the screen shows 'Cannot display this video mode'?

A: Recommended video mode for Philips 15": 1024x768 @60Hz / Philips 18" 1280x1024@60Hz.

1. Unplug all cables, then connect your PC to the monitor you used previously, which displayed correctly.
 2. In the Windows Start Menu, select Settings/Control Panel. In the Control Panel Window, select the Display icon. Inside the Display Control Panel, select the 'Settings' tab. Under the settings tab, in a box labelled 'desktop area', move the slider to 1024x768 pixels (15") / 1280x1024 pixels (18").
 3. Open 'Advanced Properties' and set the Refresh Rate to 60Hz, then click OK.
 4. Restart your computer and repeat steps 2 and 3 to verify that your PC is set at 1024x768@60Hz (15") / 1280x1024@60Hz (18").
 5. Shut down your computer, disconnect your old monitor and reconnect your Philips LCD monitor.
 6. Turn on your monitor and then turn on your PC
-

Q: What does 'refresh rate' mean in connection with an LCD monitor?

A: The refresh rate is of much less relevance for LCD monitors. LCD monitors display a stable, flicker-free image at 60Hz. There is no visible difference between 75Hz and 60Hz.

Q: What are the .inf and .icm files on the set-up disk & CD-ROM? How do I install the drivers (.inf and lcm)?

A: These are the driver files for your monitor. Follow the instructions in your user manual to install the drivers. The computer may ask you for monitor drivers (.inf and lcm files) or a driver disk when you first install your monitor. Follow the instructions to insert the driver disk (either floppy or CD-ROM) included in this package. Monitor drivers (.inf and lcm files) will be installed automatically.

Q: Why does the driver not work well at 75Hz when the vertical range for this product is defined from 56 to 75Hz ?

A: This monitor is capable of working at 1024 x 768 @75 Hz mode in terms of Horizontal Frequency

30~61kHz and Vertical refresh rate 56~75Hz. However, users of monitors (of all brands, including Philips) may encounter certain limitations when viewing Microsoft Windows on a monitor operating at 75Hz with Horizontal Frequency 30~61kHz. To serve specific needs on 75Hz, Philips provides a special driver which can work for this. This special information file is now available at website www.p4c.philips.com, and also can be found inside the CD-ROM with the following directory path `../pc/drivers/special` for your quick installation.

Q: How do I adjust the resolution?

A: Your video card/graphic driver and monitor together determine the available resolutions. You can select the desired resolution under Windows 95/98 Me & 2000/XP with the 'Display properties/Settings' control panel.

Q: What if I get lost when I am making monitor adjustments?

A: Simply press the OSD button, then select 'Reset' to recall all of the original factory settings.

Q: What is the Auto function?

A: The *AUTO adjustment* key restores the optimal screen position, phase and clock settings at the press of a single button – without the need to navigate through OSD menus and control keys.

Q: My Monitor has no power (Power LED does not light up). What should I do?

A: Make sure the power cord is connected to the Monitor.

Q: Will the product accept an Interlace signal?

A: No. If an Interlace signal is used, the screen displays both odd and even horizontal scanning lines at the same time, thus distorting the picture.

Q: What does the Refresh Rate mean for LCD?

A: Unlike CRT display technology, in which the speed at which the electron beam is swept from the top to the bottom of the screen determines flicker, an active matrix display uses an active element (TFT) to control each individual pixel and the refresh rate is therefore not really applicable to LCD technology.

Q: Will the LCD screen be resistant to scratches?

A: A protective coating is applied to the surface of the LCD, which is durable to a certain extent (approximately up to the hardness of a 2H pencil). In general, it is recommended that the panel surface is not subjected to any excessive shocks or scratches. An optional protective cover with greater scratch resistance is also available.

Q: How should I clean the LCD surface?

A: For normal cleaning, use a clean, soft cloth. For extensive cleaning, please use isopropyl alcohol. Do not use other solvents such as ethyl alcohol, ethanol, acetone, hexane, etc.

Q: Can the Philips LCD Monitor be mounted on the wall or used as a touch panel?

A: Yes, Philips LCD monitors have this optional feature. The standard VESA mount holes on the back cover allow the user to mount the Philips monitor on any VESA standard ARM or accessories. Touch panels are being developed for future applications. Check with your Philips sales representative for more information.

[RETURN TO TOP OF THE PAGE](#)

Screen Adjustments

Q: What is the FPadjust program on the setup disk and CD-ROM?

A: The FPadjust program generates alignment patterns that help you adjust monitor settings such as Contrast, Brightness, Horizontal Position, Vertical Position, Phase and Clock for optimal performance.

Q: When I install my monitor, how do I get the best performance from the monitor?

A:

1. For best performance, make sure your display settings are set at 1024x768@60Hz for 15", 1280x1024@60Hz for 18". Note: You can check the current display settings by pressing the OSD OK button once.
The current display mode is shown in the product information in the OSD main controls.
2. To install the Flat Panel Adjust (FPadjust) program located on the monitor setup CD-ROM, open the CD-ROM and double click the FP_setup03.exe icon. This will install FP Adjust automatically and

place a shortcut on your desktop.

3. Run FPadjust by double clicking the shortcut. Follow the instructions step by step to optimise image performance with your system's video controller.
-

Q: How do LCDs compare with CRTs in terms of radiation?

A: Because LCDs do not use an electron gun they do not generate the same amount of radiation at the screen surface.

[RETURN TO TOP OF THE PAGE](#)

Compatibility with other Peripherals

Q: Can I connect my LCD monitor to any PC, workstation or Mac?

A: Yes, all Philips LCD monitors are fully compatible with standard PCs, Macs and workstations. You may need a cable adapter to connect the monitor to your Mac system. Please contact your dealer/retailer for more information.

Q: Are Philips LCD monitors Plug-and-Play?

A: Yes, the monitors are Plug-and-Play compatible with Windows® 95, 98, 2000,XP and the PC98/99 platforms.

Q: What is a TV System?

A: Television pictures are not broadcast in the same way in all countries. There are different standards: BG, DK, I and L L'. The SYSTEM setting is used to select these different standards. This is not to be confused with PAL or SECAM colour coding. Pal is used in the majority of European countries, Secam in France, the CIS and the majority of African countries The United States and Japan use a different system called NTSC.

Q: What is SCART?

A: The SCART is a 20-pin rectangular connector fitted to the vast majority of PAL market TV receivers. It provides composite video inputs and outputs, stereo audio in and out, and RGB input. It is also known as Euro connector and PERI-tel.

Q: What are S-VIDEO Signals?

A: These are 2 separate Y/C video signals from the S-VIDEO and Hi-8 recording standards. The luminance signals Y (black and white) and chrominance signals C (colour) are recorded separately on the tape. This provides a better picture quality than is achieved with standard video (VHS and 8 mm) where the Y/C signals are combined to provide only one video signal.

[RETURN TO TOP OF THE PAGE](#)

LCD Panel Technology

Q: What is a Liquid Crystal Display?

A: A Liquid Crystal Display (LCD) is an optical device that is commonly used to display ASCII characters and images on digital items such as watches, calculators, portable game consoles, etc. LCD is the technology used for displays in notebooks and other small computers. Like light-emitting diode and gas-plasma technologies, LCD allows displays to be much thinner than cathode ray tube (CRT) technology. LCD consumes much less power than LED and gas-display displays because it works on the principle of blocking light rather than emitting it.

Q: How are LCDs made?

A: LCDs are created from two glass plates separated from each other at a distance of a few microns. The plates are filled with liquid crystal and then sealed together. The top plate is coloured with an RGB pattern to make the colour filter. Polarizers are then glued to both plates. This combination is sometimes called 'glass' or 'cell.' The LCD cell is assembled into a 'module' by adding the backlight, driver electronics and frame.

Q: What is polarization ?

A: Polarization is basically directing light to shine in one direction. Light is electromagnetic waves. Electric and magnetic fields oscillate in a direction perpendicular to the propagation of the light beam. The direction of these fields is called the 'polarization direction'. Normal or non-polarized light has fields in several directions; polarized light has a field in only one direction.

Q: What differentiates passive matrix LCDs from active matrix LCDs?

A: An LCD is made with either a passive matrix or an active matrix display grid. An active matrix has a transistor located at each pixel intersection, requiring less current to control the luminance of a pixel. For this reason, the current in an active matrix display can be switched on and off more

frequently, improving the screen refresh time (your mouse pointer will appear to move more smoothly across the screen, for example). The passive matrix LCD has a grid of conductors with pixels located at each intersection in the grid.

Q: How does a TFT LCD Panel work?

A: On each column and row of the TFT LCD panel a data source drive and a gate drive are attached, respectively. The TFT drain of each cell is connected to the electrode. The molecular arrangement of liquid crystal elements differs according to whether it is impressed with voltage or not. It varies the direction of polarized light and the amount of light by letting it through different arrays of liquid crystal elements. When two polarized filters are arranged vertically on a polarized light pole, the light that passes through the upper polarized panel is turned 90 degrees along with the spiral structure of the liquid crystal molecules and goes through the polarized filter at the bottom. When impressed with voltage, liquid crystal molecules are arranged vertically from the original spiral structure and the direction of the light is not turned through 90 degrees. In this case, light that comes through the top polarized panel may not go through the polarized panel at the bottom.

Q: What are the advantages of TFT LCD compared with CRT?

A: In a CRT monitor, a gun shoots electrons and general light by colliding polarized electrons on fluorescent glass. Therefore, CRT monitors basically operate with an analog RGB signal. A TFT LCD monitor is a device that displays an input image by operating a liquid crystal panel. The TFT has a fundamentally different structure than a CRT: Each cell has an active matrix structure and independent active elements. A TFT LCD has two glass panels and the space between them is filled in with liquid crystal. When each cell is connected with electrodes and impressed with voltage, the molecular structure of the liquid crystal is altered and controls the amount of inlet lighting to display images. A TFT LCD has several advantages over a CRT, since it can be very thin and no flickering occurs because it does not use the scanning method.

Q: Why is a vertical frequency of 60Hz optimal for an LCD monitor?

A: Unlike a CRT monitor, the TFT LCD panel has a fixed resolution. For example, an XGA monitor has 1024x3 (R, G, B) x 768 pixels and a higher resolution may not be available without additional software processing. The panel is designed to optimise the display for a 65MHz dot clock, one of the standards for XGA displays. Since the vertical/horizontal frequency for this dot clock is 60Hz/48kHz, the optimum frequency for this monitor is 60Hz.

Q: What kind of wide-angle technology is available? How does it work?

A: The TFT LCD panel is an element that controls/displays the inlet of a backlight using the dual-refraction of a liquid crystal. Using the property that the projection of inlet light refracts toward the major axis of the liquid element, it controls the direction of inlet light and displays it. Since the refraction ratio of inlet light on liquid crystal varies with the inlet angle of the light, the viewing angle of a TFT is much narrower than that of a CRT. Usually, the viewing angle refers to the point where the contrast ratio is 10. Many ways to widen the viewing angle are currently being developed and the most common approach is to use a wide viewing angle film, which widens the viewing angle by

varying the refraction ratio. IPS (In Plane Switching) or MVA (Multi Vertical Aligned) is also used to give a wider viewing angle.

Q: Why is there no flicker on an LCD Monitor?

A: Technically speaking, LCDs do flicker, but the cause of the phenomenon is different from that of CRT monitor -- and it has no impact of the ease of viewing. Flickering in an LCD monitor relates to usually undetectable luminance caused by the difference between positive and negative voltage. On the other hand, CRT flickering that can irritate the human eye occurs when the on/off action of the fluorescent object becomes visible. Since the reaction speed of liquid crystal in an LCD panel is much slower, this troublesome form of flickering is not present in an LCD display.

Q: Why is an LCD monitor virtually free of Electro Magnetic Interference?

A: Unlike a CRT, an LCD monitor does not have key parts that generate Electro Magnetic Interference, especially magnetic fields. Also, since an LCD display utilizes relatively low power, its power supply is extremely quiet.

[RETURN TO TOP OF THE PAGE](#)

Ergonomics, Ecology and Safety Standards

Q: What is the CE mark?

A: The CE (Conformité Européenne) mark is required to be displayed on all regulated products offered for sale on the European market. This 'CE' mark means that a product complies with the relevant European Directive. A European Directive is a European 'Law' that relates to health, safety, environment and consumer protection, much the same as the U.S. National Electrical Code and UL Standards.

Q: Does the product conform to general safety standards?

A: Yes. Philips LCD monitors conform to the guidelines of MPR-II and TCO 95 standards for the control of radiation, electromagnetic waves, energy reduction, electrical safety in the work environment and recyclability. The specification page provides detailed data on safety standards.

More information is provided in the [Regulatory Information](#) section.

[RETURN TO TOP OF THE PAGE](#)

Troubleshooting

[Safety and Troubleshooting](#) • [FAQs](#) • [Common Problems](#) • [Imaging Problems](#) • [TV and Audio Problems](#) • [Regulatory Information](#) • [Other Related Information](#)

This page deals with problems that can be corrected by the user. If the problem still persists after you have tried these solutions, contact your nearest Philips dealer.

Common Problems

Having this problem?	Check these items
<p>No Picture (Power LED not lit)</p>	<ul style="list-style-type: none"> ● Make sure the Power cable is plugged to the wall and the back of the monitor. ● Firstly, ensure that the power button in front of the monitor is in the OFF position, then press it to the ON position again.
<p>No Picture (Power LED is flashing)</p>	<ul style="list-style-type: none"> ● Make sure the computer is turned on. ● Make sure the signal cable is properly connected to your computer. ● Check to see if the monitor cable has bent pins. ● The Energy Saving feature may be activated
<p>Screen says</p> 	<ul style="list-style-type: none"> ● Make sure the monitor cable is properly connected to your computer. (Also refer to the Quick Set-Up Guide). ● Check to see if the monitor cable has bent pins. ● Make sure the computer is turned on.
<p>AUTO button not working properly</p>	<ul style="list-style-type: none"> ● The Auto Function is designed for use on standard Macintosh or IBM-compatible PCs running Microsoft Windows. ● It may not work properly if you are using a non-standard PC or video card.

Imaging Problems

<p>Display position is incorrect</p>	<ul style="list-style-type: none"> ● Press the Auto button. ● Adjust the image position using the Horizontal Position &/or Vertical Position in OSD Main Controls.
<p>Image vibrates on the screen</p>	<ul style="list-style-type: none"> ● Check that the signal cable is properly connected to the graphics board or PC.

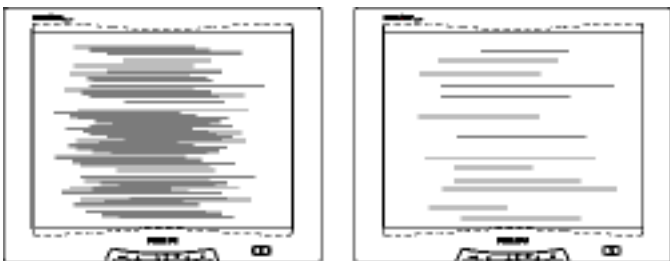
<p>Vertical flicker appears</p> 	<ul style="list-style-type: none"> ● Press the Auto button. ● Eliminate the vertical bars using the Clock Adjustment of VIDEO NOISE in OSD Main Controls.
<p>Horizontal flicker appears</p> 	<ul style="list-style-type: none"> ● Press the Auto button. ● Eliminate the horizontal bars using the Phase Adjustment of VIDEO NOISE in OSD Main Controls.
<p>The screen is too bright or too dark</p>	<ul style="list-style-type: none"> ● Adjust the contrast and brightness in OSD Main Controls. (The backlight of the product has a fixed life span. When the screen becomes dark or begins to flicker, please contact your dealer.
<p>An after-image appears</p>	<ul style="list-style-type: none"> ● If an image remains on the screen for an extended period of time, it may be imprinted in the screen and leave an afterimage This usually disappears after a few hours
<p>An afterimage remains after the power has been turned off.</p>	<ul style="list-style-type: none"> ● This is characteristic of liquid crystal and is not caused by a malfunction or deterioration of the liquid crystal. The afterimage will disappear after a given amount of time
<p>Green, red, blue, dark and white dots remain.</p>	<ul style="list-style-type: none"> ● The remaining dots are normal characteristic of the liquid crystal used in today's technology.
<p>Visible brighter spots in dark scenes</p>	<ul style="list-style-type: none"> ● The brighter spots are normal when the ambient light is very low. ● Increase the ambient light to make the spots invisible

TV and Audio Problems

Poor TV signal reception

- The proximity of mountains or high buildings may be responsible for ghost pictures, echoing or shadows. In this case, try manually adjusting your pictures: see 'fine tuning' or adjust the direction of the outside aerial. For Asia users in non-NTSC area: Does your antenna enable you to receive broadcasts in this frequency range (UHF or VHF band)? In the event of difficult reception (snowy pictures) switch the NR on the PICTURE menu to ON.

No TV picture

- Have you connected the aerial socket properly? Have you chosen the right system? Poorly connected SCART cables or aerial sockets are often the cause of picture or sound problems (sometimes the connectors can become half disconnected if the Monitor set is moved or turned). Check all connections.

No sound

- Ensure that the audio cables are firmly connected to both the audio input connectors on your Monitor and audio output connectors on your PC or Video player.
- If on certain TV channels you receive a picture but no sound, this means that you do not have the correct TV system. Modify the SYSTEM setting.

For further assistance, refer to the [Consumer Information Centres](#) list and contact your local Philips distributor.

[RETURN TO TOP OF THE PAGE](#)

Regulatory Information

[TCO '95 Information](#) • [TCO Environmental Requirements](#) • [CE Declaration of Conformity](#) • [Energy Star Declaration](#) • [Federal Communications Commission \(FCC\) Notice \(U.S. Only\)](#) • [Commission Federale de la Communication \(FCC Declaration\)](#) • [EN 55022 Compliance \(Czech Republic Only\)](#) • [VCCI Class 2 Notice \(Japan Only\)](#) • [MIC Notice \(South Korea Only\)](#) • [Polish Center for Testing and Certification Notice](#) • [North Europe \(Nordic Countries\) Information](#) • [BSMI Notice \(Taiwan Only\)](#) • [Ergonomie Hinweis \(nur Deutschland\)](#) • [Philips End-of-Life Disposal](#) • [Information for UK only](#)

[Safety and Troubleshooting](#) • [Troubleshooting](#) • [Other Related Information](#) • [Frequently Asked Questions \(FAQs\)](#)

TCO '95 Information



Congratulations!

You have just purchased a TCO'95 approved and labelled product! Your choice has provided you with a product developed for professional use. Your purchase has also contributed to reducing the burden on the environment and also, to the further development of environmentally adapted electronics products.

Why do we have environmentally labelled computers?

In many countries, environmental labelling has become an established method for encouraging the adaptation of goods and services to the environment. The main problem, as far as computers and other electronics equipment are concerned, is that environmentally harmful substances are used both in the products and during the manufacturing. Since it has not been possible for the majority of electronics equipment to be recycled in a satisfactory way, most of these potentially damaging substances sooner or later enter Nature. There are also other characteristics of a computer, such as energy consumption levels, that are important from the viewpoints of both the work (internal) and natural (external) environments. Since all methods of conventional electricity generation have a negative effect on the environment (acidic and climate-influencing emissions, radioactive waste, etc.), it is vital to conserve energy. Electronics equipment in offices

consume an enormous amount of energy since they are often left running continuously.

What does labelling involve?

This product meets the requirements for the TCO'95 scheme which provides for international and environmental labelling of personal computers. The labelling scheme was developed as a joint effort by the TCO (The Swedish Confederation of Professional Employees), Naturskyddsforeningen (The Swedish Society for Nature Conservation) and NUTEK (The National Board for Industrial and Technical Development in Sweden). The requirements cover a wide range of issues: environment, ergonomics, usability, emission of electrical and magnetic fields, energy consumption and electrical and fire safety. The environmental demands concern restrictions on the presence and use of heavy metals, brominated and chlorinated flame retardants, CFCs (freons) and chlorinated solvents, among other things. The product must be prepared for recycling and the manufacturer is obliged to have an environmental plan which must be adhered to in each country where the company implements its operational policy. The energy requirements include a demand that the computer and/or display, after a certain period of inactivity, shall reduce its power consumption to a lower level in one or more stages. The length of time to reactivate the computer shall be reasonable for the user.

Labelled products must meet strict environmental demands, for example, in respect of the reduction of electric and magnetic fields, physical and visual ergonomics and good usability. On the back page of this folder, you will find a brief summary of the environmental requirements met by this product. The complete environmental criteria document may be ordered from:

TCO Development Unit

SE-114 94 Stockholm, Sweden

Fax: +46 8 782 92 07

Email (Internet): development@tco.se

Current information regarding TCO'95 approved and labelled products may also be obtained via the Internet, using the address: <http://www.tco-info.com/>

TCO'95 is a co-operative project between TCO (The Swedish Confederation of Professional Employees), Naturskyddsforeningen (The Swedish Society for Nature Conservation) and NUTEK (The National Board for Industrial and Technical Development in Sweden).

Environmental Requirements

Brominated flame retardants

Brominated flame retardants are present in printed circuit boards, cables, wires, casings and housings. In turn, they delay the spread of fire. Up to thirty percent of the plastic in a computer casing can consist of flame retardant substances. These are related to another group of environmental toxins, PCBs, which are suspected to give rise to similar harm, including reproductive damage in fish-eating birds and mammals, due to the bio-accumulative * processes. Flame retardants have been found in human blood and researchers fear that disturbances in foetus development may occur.

TCO'95 demand requires that plastic components weighing more than 25 grams must not contain organically bound chlorine and bromine.

Lead **

Lead can be found in picture tubes, display screens, solders and capacitors. Lead damages the nervous system and in higher doses, causes lead poisoning. TCO'95 requirement permits the inclusion of lead since no replacement has yet been developed.

Cadmium**

Cadmium is present in rechargeable batteries and in the colour-generating layers of certain computer displays. Cadmium damages the nervous system and is toxic in high doses. The relevant TCO'99 requirement states that batteries, the colour-generating layers of display screens and the electrical or electronics components must not contain any cadmium.

Mercury**

Mercury is sometimes found in batteries, relays and switches. Mercury damages the nervous system and is toxic in high doses. TCO'95 requirement states that batteries may not contain more than 25 ppm (parts per million) of mercury. It also demands that no mercury is present in any of the electrical or electronics components concerned with the display unit. Mercury is, for the time being, permitted in the back light system of flat panel monitors as there today is no commercially available alternative. TCO aims on removing this exception when a mercury free alternative is available.

CFCs (freons)

CFCs (freons) are sometimes used for washing printed circuit boards and in the manufacturing of expanded foam for packaging. CFCs break down ozone and thereby damage the ozone layer in the stratosphere, causing increased reception on Earth of ultraviolet light with consequent increased risks of skin cancer (malignant melanoma). The relevant TCO'95 requirement: Neither CFCs nor HCFCs may be used during the manufacturing of the product or its packaging.

The TCO'95 requirement: neither CFCs nor HCFCs may be used during the manufacturing of the product or its packaging.

* *Bio-accumulative is defined as substances which accumulate within living organisms*

** *Lead, Cadmium and Mercury are heavy metals which are Bio-accumulative.*

[RETURN TO TOP OF THE PAGE](#)

CE Declaration of Conformity

Philips Consumer Electronics declare under our responsibility that the product is in conformity with the following standards

- EN60950:1992+A1+A2+A3+A4+A11 (Safety requirement of Information Technology Equipment)
 - EN55022:1998 (Radio Disturbance requirement of Information Technology Equipment)
 - EN55024:1998 (Immunity requirement of Information Technology Equipment)
 - EN61000-3-2:1995 (Limits for Harmonic Current Emission)
 - EN61000-3-3:1995 (Limitation of Voltage Fluctuation and Flicker)
 - EN55013:1990+A12+A13+A14 (Radio Disturbance requirement of Sound and Television Receivers and associated)
 - EN55020:1994+A12 (Immunity requirement of Sound and Television Receivers and associated)
 - IEC Guide 112:2000 (Guide on the Safety of Multimedia Equipment) following provisions of directives applicable
 - 73/23/EEC (Low Voltage Directive)
 - 89/336/EEC (EMC Directive)
 - 93/68/EEC (Amendment of EMC and Low Voltage Directive)
- and is produced by a manufacturing organization on ISO9000 level.

The product also comply with the following standards

- ISO9241-3, ISO9241-7, ISO9241-8 (Ergonomic requirement for Visual Display)
- ISO13406-2 (Ergonomic requirement for Flat panels)
- GS EK1-2000 (GS specification)
- prEN50279:1998 (Low Frequency Electric and Magnetic fields for Visual Display)
- MPR-II (MPR:1990:8/1990:10 Low Frequency Electric and Magnetic fields)
- TCO95, TCO99 (Requirement for Environment Labelling of Ergonomics, Energy, Ecology and Emission, TCO: Swedish Confederation of Professional Employees) for TCO versions

[RETURN TO TOP OF THE PAGE](#)

Energy Star Declaration

PHILIPS 150MT

This monitor is equipped with a function for saving energy which supports the VESA Display Power Management Signaling (DPMS) standard. This means that the monitor must be connected to a computer which supports VESA DPMS to fulfill the requirements in the NUTEK specification 803299/94. Time settings are adjusted from the system unit by software.

NUTEK	VESA State	LED Indicator	Power Consumption
Normal operation	ON	Green	48 W (typical)
Power Saving Alternative 2 One step	OFF	Flashing Green	< 2 W



As an ENERGY STAR® Partner, PHILIPS has determined that this product meets the ENERGY STAR® guidelines for energy efficiency.



We recommend you switch off the monitor when it is not in use for quite a long time.

[RETURN TO TOP OF THE PAGE](#)

Federal Communications Commission (FCC) Notice (U.S. Only)



This equipment has been tested and found to comply with the limits for a Class B digital device, pursuant to Part 15 of the FCC Rules. These limits are designed to provide reasonable protection against harmful interference in a residential installation. This equipment generates, uses and can radiate radio frequency energy and, if not installed and used in accordance with the instructions, may cause harmful interference to radio communications. However, there is no guarantee that interference will not occur in a particular installation. If this equipment does cause harmful interference to radio or television reception, which can be determined by turning the equipment off and on, the user is encouraged to try to correct the interference by one or more of the following measures:

- Reorient or relocate the receiving antenna.
- Increase the separation between the equipment and receiver.
- Connect the equipment into an outlet on a circuit different from that to which the receiver is connected.
- Consult the dealer or an experienced radio/TV technician for help.



Changes or modifications not expressly approved by the party responsible for compliance could void the user's authority to operate the equipment.

Use only RF shielded cable that was supplied with the monitor when connecting this monitor to a computer device.

To prevent damage which may result in fire or shock hazard, do not expose this appliance to rain or excessive moisture.

THIS CLASS B DIGITAL APPARATUS MEETS ALL REQUIREMENTS OF THE CANADIAN INTERFERENCE-CAUSING EQUIPMENT REGULATIONS.

[RETURN TO TOP OF THE PAGE](#)

Commission Federale de la Communication (FCC Declaration)



Cet équipement a été testé et déclaré conforme aux limites des appareils numériques de class B, aux termes de l'article 15 Des règles de la FCC. Ces limites sont conçues de façon à fournir une protection raisonnable contre les interférences nuisibles dans le cadre d'une installation résidentielle. CET appareil produit, utilise et peut émettre des hyperfréquences qui, si l'appareil n'est pas installé et utilisé selon les consignes données, peuvent causer des interférences nuisibles aux communications radio. Cependant, rien ne peut garantir l'absence d'interférences dans le cadre d'une installation particulière. Si cet appareil est la cause d'interférences nuisibles pour la réception des signaux de radio ou de télévision, ce qui peut être décelé en fermant l'équipement, puis en le remettant en fonction, l'utilisateur pourrait essayer de corriger la situation en prenant les mesures suivantes:

- Réorienter ou déplacer l'antenne de réception.
- Augmenter la distance entre l'équipement et le récepteur.
- Brancher l'équipement sur un autre circuit que celui utilisé par le récepteur.
- Demander l'aide du marchand ou d'un technicien chevronné en radio/télévision.



Toutes modifications n'ayant pas reçu l'approbation des services compétents en matière de conformité est susceptible d'interdire à l'utilisateur l'usage du présent équipement.

N'utiliser que des câbles RF armés pour les connections avec des ordinateurs ou périphériques.

CET APPAREIL NUMERIQUE DE LA CLASSE B RESPECTE TOUTES LES EXIGENCES DU REGLEMENT SUR LE MATERIEL BROUILLEUR DU CANADA.

[RETURN TO TOP OF THE PAGE](#)

EN 55022 Compliance (Czech Republic Only)

This device belongs to category B devices as described in EN 55022, unless it is specifically stated that it is a Class A device on the specification label. The following applies to devices in Class A of EN 55022 (radius of protection up to 30 meters). The user of the device is obliged to take all steps necessary to remove sources of interference to telecommunication or other devices.

Pokud není na typovém štítku počítače uvedeno, že spadá do třídy A podle EN 55022, spadá automaticky do třídy B podle EN 55022. Pro zařízení zařazená do třídy A (chranné pásmo 30m) podle EN 55022 platí následující. Dojde-li k rušení telekomunikačních nebo jiných zařízení je uživatel povinen provést taková opatření, aby rušení odstranil.

[RETURN TO TOP OF THE PAGE](#)

VCCI Notice (Japan Only)

This is a Class B product based on the standard of the Voluntary Control Council for Interference (VCCI) for Information technology equipment. If this equipment is used near a radio or television receiver in a domestic environment, it may cause radio Interference. Install and use the equipment according to the instruction manual.



Class B ITE

この装置は、情報処理装置等電波障害自主規制協議会 (VCCI) の基準に基づくクラス B 情報技術装置です。この装置は家庭環境で使用することを目的としていますが、この装置がラジオやテレビジョン受信機に近接して使用されると、受信障害を引き起こすことがあります。
取扱説明書に従って正しい取り扱いをして下さい。

[RETURN TO TOP OF THE PAGE](#)

MIC Notice (South Korea Only)

Class B Device

장치 종류	사용자 안내문
B급 기기	이 장치는 가정용으로 전자파 적합등록을 한 장치로서 주거지역에서는 물론 모든 지역에서 사용할 수 있습니다.



Please note that this device has been approved for non-business purposes and may be used in any environment, including residential areas.

[RETURN TO TOP OF THE PAGE](#)

Polish Center for Testing and Certification Notice

The equipment should draw power from a socket with an attached protection circuit (a three-prong socket). All equipment that works together (computer, monitor, printer, and so on) should have the same power supply source.

The phasing conductor of the room's electrical installation should have a reserve short-circuit protection device in the form of a fuse with a nominal value no larger than 16 amperes (A).

To completely switch off the equipment, the power supply cable must be removed from the power supply socket, which should be located near the equipment and easily accessible.

A protection mark "B" confirms that the equipment is in compliance with the protection usage requirements of standards PN-93/T-42107 and PN-89/E-06251.

Wymagania Polskiego Centrum Badań i Certyfikacji

Urządzenie powinno być zasilane z gniazda z przyłączonym obwodem ochronnym (gniazdo z kolkiem). Współpracujące ze sobą urządzenia (komputer, monitor, drukarka) powinny być zasilane z tego samego źródła.

Instalacja elektryczna pomieszczenia powinna zawierać w przewodzie fazowym rezerwową ochronę przed zwarciami, w postaci bezpiecznika o wartości znamionowej nie większej niż 16A (amperów).

W celu całkowitego wyłączenia urządzenia z sieci zasilania, należy wyjąć wtyczkę kabla zasilającego z gniazdka, które powinno znajdować się w pobliżu urządzenia i być łatwo dostępne.

Znak bezpieczeństwa "B" potwierdza zgodność urządzenia z wymaganiami bezpieczeństwa użytkowania zawartymi w PN-93/T-42107 i PN-89/E-06251.

Pozostałe instrukcje bezpieczeństwa

- Nie należy używać wtyczek adapterowych lub usuwać kolka obwodu ochronnego z wtyczki. Jeżeli konieczne jest użycie przedłużacza to należy użyć przedłużacza 3-żyłowego z prawidłowo połączonym przewodem ochronnym.
- System komputerowy należy zabezpieczyć przed nagłymi, chwilowymi wzrostami lub spadkami napięcia, używając eliminatora przepięć, urządzenia dopasowującego lub bezzakłócenieniowego źródła zasilania.
- Należy upewnić się, aby nic nie leżało na kablach systemu komputerowego, oraz aby kable nie były umieszczone w miejscu, gdzie można byłoby na nie nadeptywać lub potykać się o nie.
- Nie należy rozlewać napojów ani innych płynów na system komputerowy.
- Nie należy wpychać żadnych przedmiotów do otworów systemu komputerowego, gdyż może to spowodować pożar lub porażenie prądem, poprzez zwarcie elementów wewnętrznych.
- System komputerowy powinien znajdować się z dala od grzejników i źródeł ciepła. Ponadto, nie należy blokować otworów wentylacyjnych. Należy unikać kładzenia luźnych papierów pod komputer oraz umieszczania komputera w ciasnym miejscu bez możliwości cyrkulacji powietrza wokół niego.

[RETURN TO TOP OF THE PAGE](#)

North Europe (Nordic Countries) Information

Placering/Ventilation

VARNING:

FÖRSÄKRA DIG OM ATT HUVUDBRYTARE OCH UTTAG ÄR LÄTÅTKOMLIGA, NÄR DU STÄLLER DIN UTRUSTNING PÅPLATS.

Placering/Ventilation

ADVARSEL:

SØRG VED PLACERINGEN FOR, AT NETLEDNINGENS STIK OG STIKKONTAKT ER NEMT TILGÆNGELIGE.

Paikka/Ilmankierto

VAROITUS:

SIJOITA LAITE SITEN, ETTÄ VERKKOJOHTO VOIDAAN TARVITTAESSA HELPOSTI IRROTTAA PISTORASIASTA.

Plassering/Ventilasjon

ADVARSEL:

NÅR DETTE UTSTYRET PlassERES, MÅ DU PASSE PÅ AT KONTAKTENE FOR STØMTILFØRSEL ER LETTE Å NÅ.

[RETURN TO TOP OF THE PAGE](#)

BSMI Notice (Taiwan Only)

符合乙類資訊產品之標準

[RETURN TO TOP OF THE PAGE](#)

Ergonomie Hinweis (nur Deutschland)

Der von uns gelieferte Farbmonitor entspricht den in der "Verordnung über den Schutz vor Schäden durch Röntgenstrahlen" festgelegten Vorschriften.

Auf der Rückwand des Gerätes befindet sich ein Aufkleber, der auf die Unbedenklichkeit der Inbetriebnahme hinweist, da die Vorschriften über die Bauart von Störstrahlern nach Anlage III α 5 Abs. 4 der Röntgenverordnung erfüllt sind.

Damit Ihr Monitor immer den in der Zulassung geforderten Werten entspricht, ist darauf zu achten, daß

1. Reparaturen nur durch Fachpersonal durchgeführt werden.
2. nur original-Ersatzteile verwendet werden.
3. bei Ersatz der Bildröhre nur eine bauartgleiche eingebaut wird.

Aus ergonomischen Gründen wird empfohlen, die Grundfarben Blau und Rot nicht auf dunklem Untergrund zu verwenden (schlechte Lesbarkeit und erhöhte Augenbelastung bei zu geringem Zeichenkontrast wären die Folge).

Der arbeitsplatzbezogene Schalldruckpegel nach DIN 45 635 beträgt 70dB (A) oder weniger.



ACHTUNG: BEIM AUFSTELLEN DIESES GERÄTES DARAUFG ACHTEN, DAß NETZSTECKER UND NETZKABELANSCHLUß LEICHT ZUGÄNGLICH SIND.

[RETURN TO TOP OF THE PAGE](#)

End-of-Life Disposal

Your new monitor contains materials that can be recycled and reused. Specialized companies can recycle your product to increase the amount of reusable materials and to minimize the amount to be disposed of.

Please find out about the local regulations on how to dispose of your old monitor from your local Philips dealer.

[RETURN TO TOP OF THE PAGE](#)

Information for UK only

WARNING - THIS APPLIANCE MUST BE EARTHED.

Important:

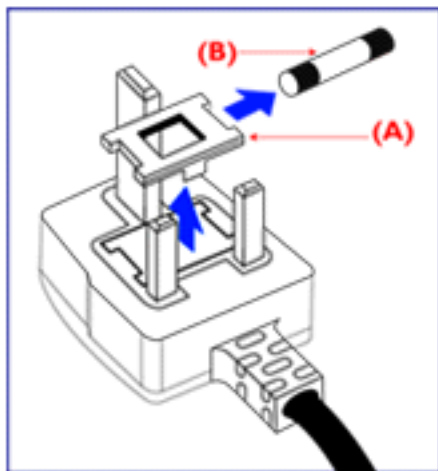

This apparatus is supplied with an approved moulded 13A plug. To change a fuse in this type of plug proceed as follows:

1. Remove fuse cover and fuse.
2. Fit new fuse which should be a BS 1362 5A,A.S.T.A. or BSI approved type.
3. Refit the fuse cover.

If the fitted plug is not suitable for your socket outlets, it should be cut off and an appropriate 3-pin plug fitted in its place.

If the mains plug contains a fuse, this should

have a value of 5A. If a plug without a fuse is used, the fuse at the distribution board should not be greater than 5A.

Note: The severed plug must be destroyed to avoid a possible shock hazard should it be inserted into a 13A socket elsewhere.

How to connect a plug

The wires in the mains lead are coloured in accordance with the following code:

BLUE - "NEUTRAL" ("N")

BROWN - "LIVE" ("L")

GREEN & YELLOW - "EARTH" ("E")

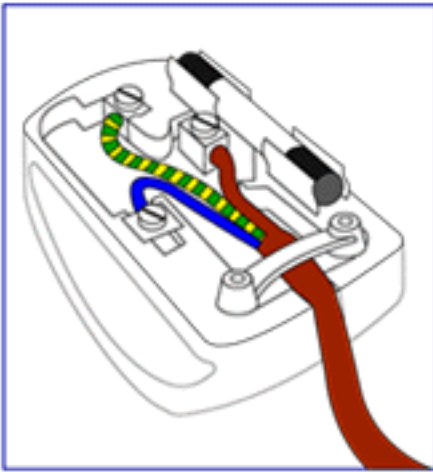

1. The GREEN AND YELLOW wire must be connected to the terminal in the plug which is marked with the letter "E" or by the Earth symbol  or coloured GREEN or GREEN AND YELLOW.

2. The BLUE wire must be connected to the terminal which is marked with the letter "N" or coloured BLACK.

3. The BROWN wire must be connected to the terminal which marked with the letter "L" or coloured RED.

Before replacing the plug cover, make certain that the cord grip is clamped over the sheath of the lead - not simply over the three wires.

[RETURN TO TOP OF THE PAGE](#)

Other Related Information

[Safety and Troubleshooting](#) • [FAQs](#) • [Troubleshooting](#) • [Regulatory Information](#) • [Information for Users in the U. S.](#) • [Information for Users Outside the U.S](#)

Information for Users in the U. S.

For units set at 115 V :

Use a UL Listed Cord Set consisting of a minimum 18 AWG, Type SVT or SJT three conductor cord a maximum of 15-feet long and a parallel blade, grounding type attachment plug rated 15 A, 125 V.

For units set at 230 V:

Use a UL Listed Cord Set consisting of a minimum 18 AWG, Type SVT or SJT three conductor cord a maximum of 15-feet long and a tandem blade, grounding type attachment plug rated 15 A, 250 V.

Information for Users outside the U.S.

For units set at 230 V:

Use a Cord Set consisting of a minimum 18 AWG cord and grounding type attachment plug rated 15 A, 250 V. The Cord Set should have the appropriate safety approvals for the country in which the equipment will be installed and / or be marked HAR.

[RETURN TO TOP OF THE PAGE](#)

Philips Pixel Defect Policy

[Product Features](#) • [Technical Specifications](#) • [Resolution & Preset Modes](#) • [Automatic Power Saving](#) • [Physical Specification](#) • [Pin Assignment](#) • [Product Views](#)

Philips' LCD Panel Pixel Defect Policy

Philips strives to deliver the highest quality products. We use some of the industry's most advanced manufacturing processes and practise stringent quality control. However, pixel or sub pixel defects on the TFT LCD panels used in flat panel monitors are sometimes unavoidable. No manufacturer can guarantee that all panels will be free from pixel defects, but Philips guarantees that any monitor with an unacceptable number of defects will be repaired or replaced under warranty. This notice explains the different types of pixel defects and defines acceptable defect levels for each type. In order to qualify for repair or replacement under warranty, the number of pixel defects on a TFT LCD panel must exceed these acceptable levels. For example, no more than 0.0004% of the sub pixels on a 15" XGA monitor may be defective. Furthermore, Philips sets even higher quality standards for certain types or combinations of pixel defects that are more noticeable than others.

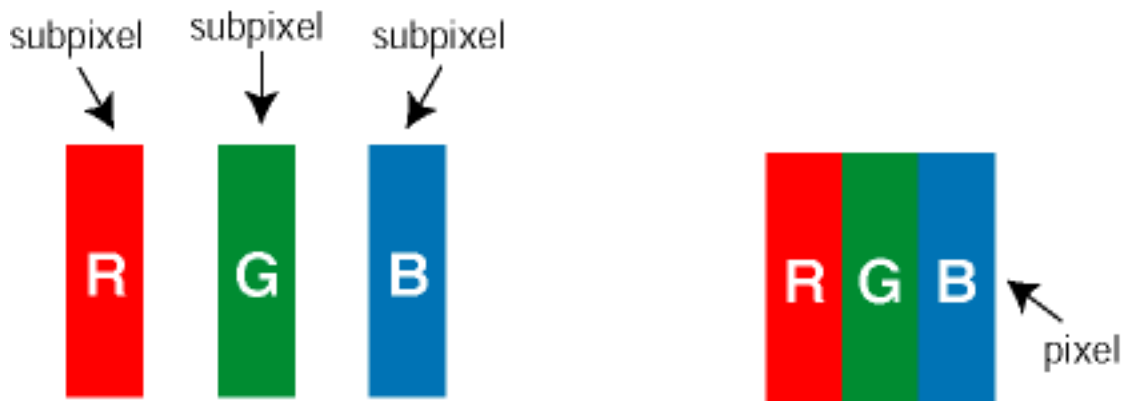

Pixels and Sub pixels

A pixel, or picture element, is composed of three sub pixels in the primary colors of red, green and blue. Many pixels together form an image. When all sub pixels of a pixel are lit, the three colored subpixels together appear as a single white pixel. When all are dark, the three colored sub pixels together appear as a single black pixel. Other combinations of lit and dark sub pixels appear as single pixels of other colors.

Types of Pixel Defects

Pixel and sub pixel defects appear on the screen in different ways. There are two categories of pixel defects and several types of sub pixel defects within each category.

Bright Dot Defects appear as pixels or sub pixels that are always lit or 'on'. These are the types of bright dot defects:

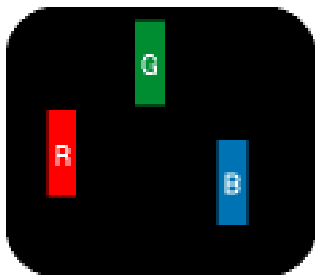

One lit red, green or blue sub pixel

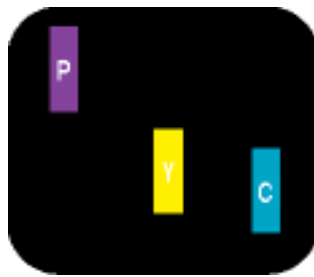

Two adjacent lit sub pixels:
 - Red + Blue = Purple
 - Red + Green = Yellow
 - Green + Blue = Cyan (Light Blue)



Three adjacent lit sub pixels (one white pixel)

Black Dot Defects appear as pixels or sub pixels that are always dark or 'off'. These are the types of black dot defects:

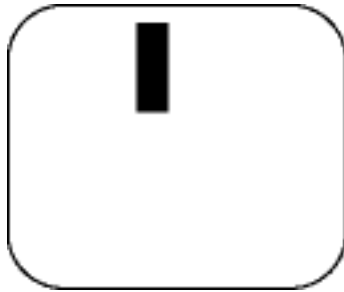

One dark sub pixel

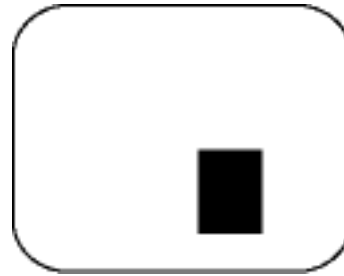

Two or three adjacent dark sub pixels

Proximity of Pixel Defects

Because pixel and sub pixels defects of the same type that are near to one another may be more noticeable, Philips also specifies tolerances for the proximity of pixel defects.

Pixel Defect Tolerances

In order to qualify for repair or replacement due to pixel defects during the warranty period, a TFT LCD panel in a Philips flat panel monitor must have pixel or sub pixel defects exceeding the tolerances listed in the following tables.

BRIGHT DOT DEFECTS	ACCEPTABLE LEVEL	
	150MT	180MT
MODEL		
1 lit sub pixel	4 or fewer	3 or fewer
2 adjacent lit sub pixels	2 or fewer	2 or fewer
3 adjacent lit sub pixels (one white pixel)	0	0
Distance between two bright dot defects*	15 mm or more	15mm or more
Bright dot defects within 20 mm circle	3 or fewer	-

Total bright dot defects of all types	4 or fewer	3 or fewer
---------------------------------------	------------	------------

BLACK DOT DEFECTS	ACCEPTABLE LEVEL	
	150MT	180MT
<i>MODEL</i>		
1 dark sub pixel	4 or fewer	3 or fewer
2 adjacent dark sub pixels	2 or fewer	2 or fewer
3 adjacent dark sub pixels	0	0
Distance between two black dot defects*	15 mm or more	15 mm or more
Black dot defects within 20 mm circle*	3 or fewer	-
Total black dot defects of all types	4 or fewer	3 or fewer

TOTAL DOT DEFECTS	ACCEPTABLE LEVEL	
	150MT	180MT
<i>MODEL</i>		
Total bright or black dot defects of all types	4 or fewer	6 or fewer

Note: 1 or 2 adjacent sub pixel defects = 1 dot defect

[RETURN TO TOP OF THE PAGE](#)

Connecting to Your PC, TV Antenna, DVD/VCR etc.

[Front View Product Description](#) • [Accessory Pack](#) • [Connecting to Your PC, TV Antenna, DVD/VCR etc.](#) • [Removing and Re-installing the Base](#) • [Basic Monitor TV Connections](#) • [Getting Started](#) • [Optimising Performance](#)

Accessory Pack

Unpack all the parts.

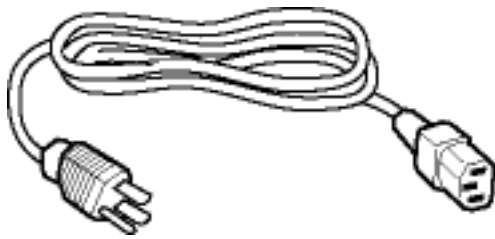

Power cable

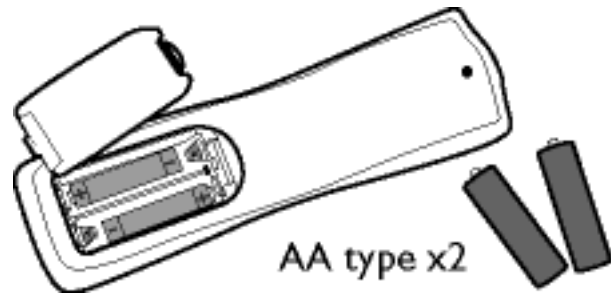

Remote control & batteries



PC audio-in cable



VGA signal cable

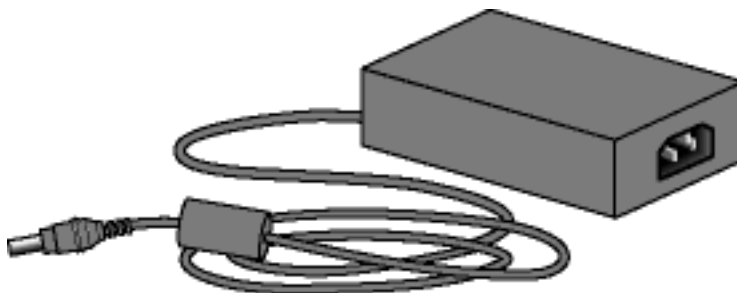

Power adapter
(Use only AC/DC adapter model
SA165A-1250V-3P)

E-DFU pack

[RETURN TO TOP OF THE PAGE](#)

Setting up and connecting your monitor/TV

Ensure that the power to the monitor/TV is switched off before the installation.

- Connecting the monitor/TV

- Connect the cables to the back of your monitor/TV by following step 1~7:

(Europe)

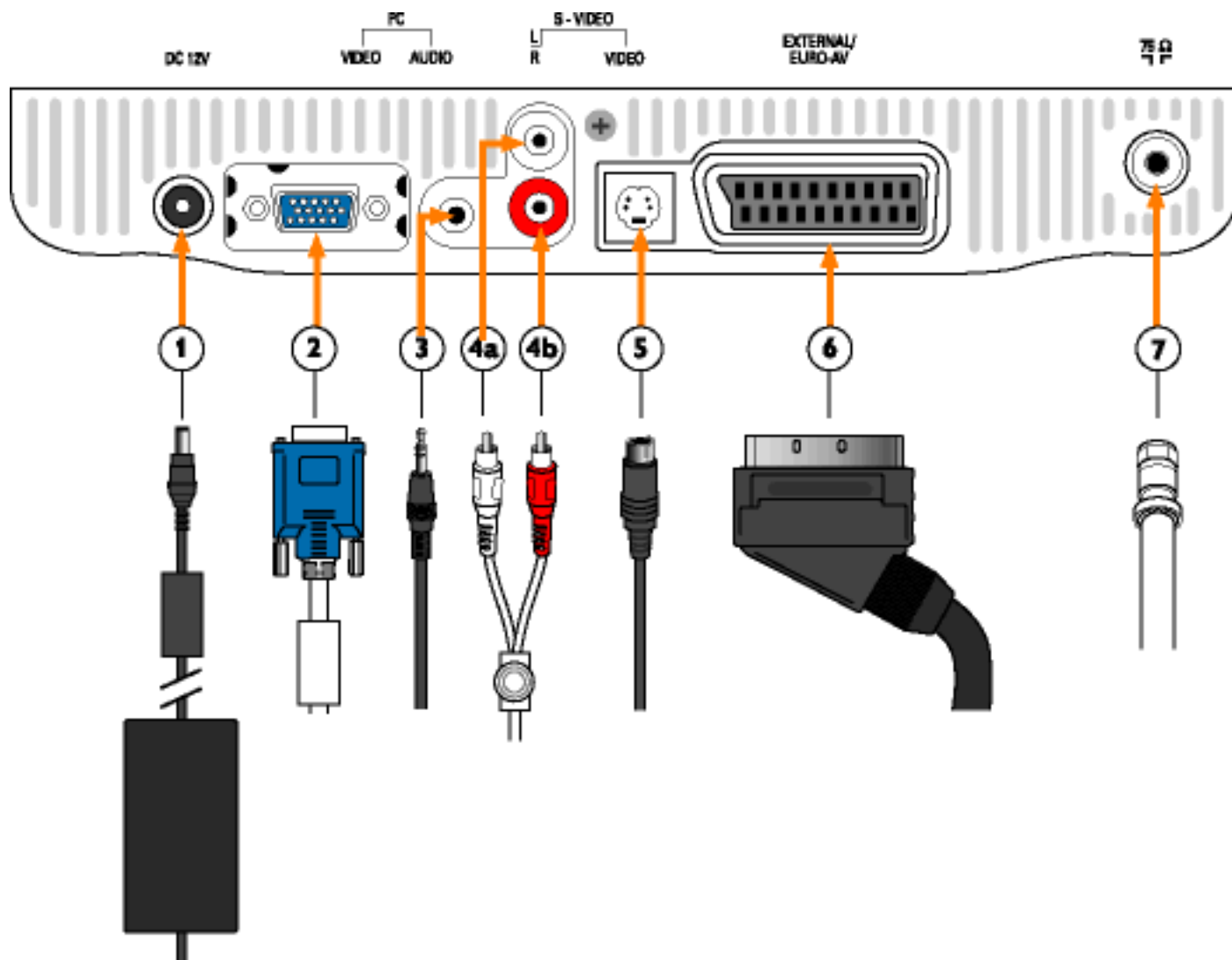

(North America and Asia Pacific)

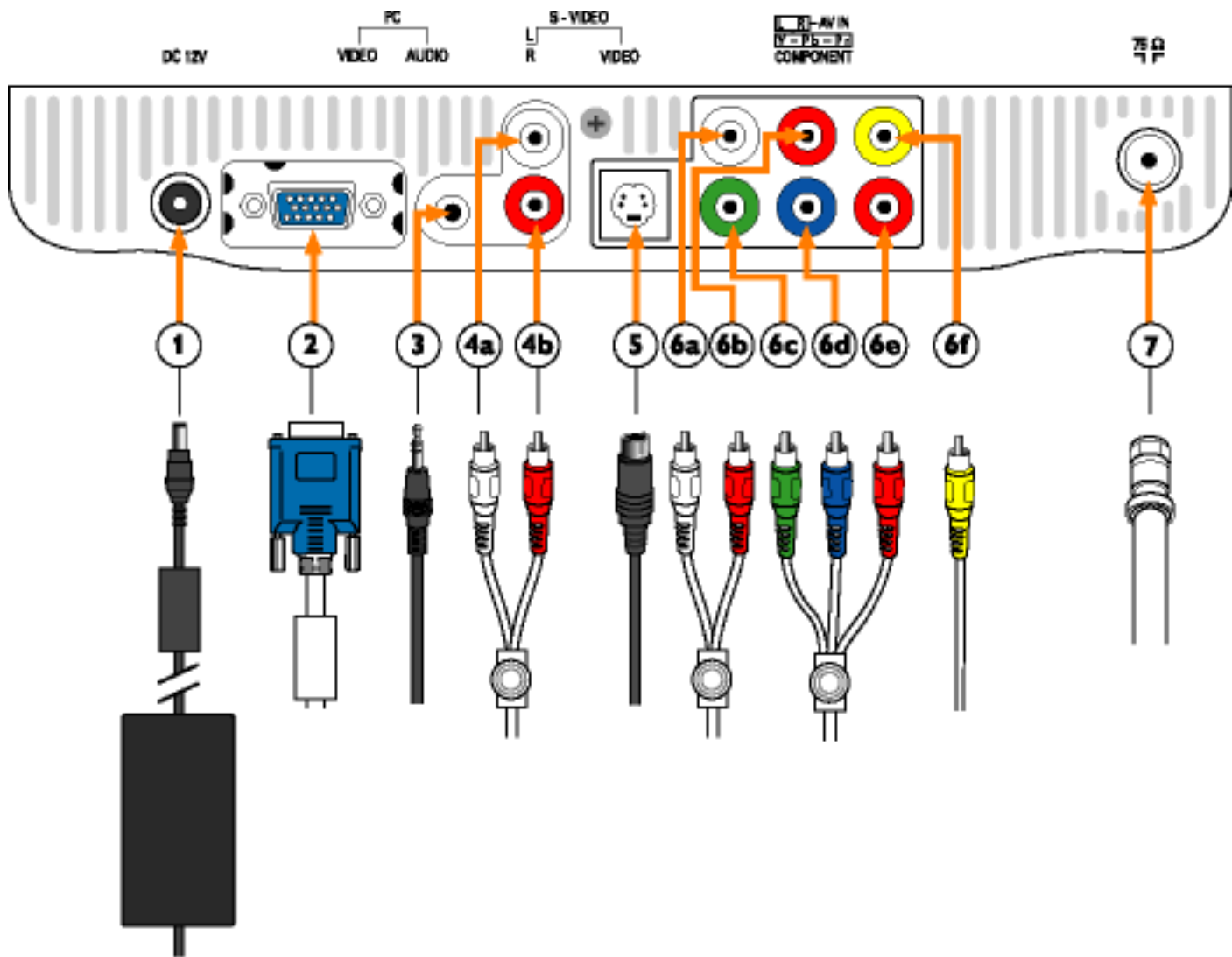

[RETURN TO TOP OF THE PAGE](#)

- Connect to PC

- Connect the cables to the back of your computer by following step 1~6
- Switch on the power to your computer and monitor/TV and make sure the PC mode is selected (). If it is not, press the PC, TV/VIDEO selection button to select the PC mode.
- If your monitor displays the computer image the installation has been completed successfully.
- If installation was not successful, see the [Troubleshooting](#) section.
- For installation of the monitor driver for Microsoft Windows, see the Monitor Driver

Installation section ([Getting Started](#)).

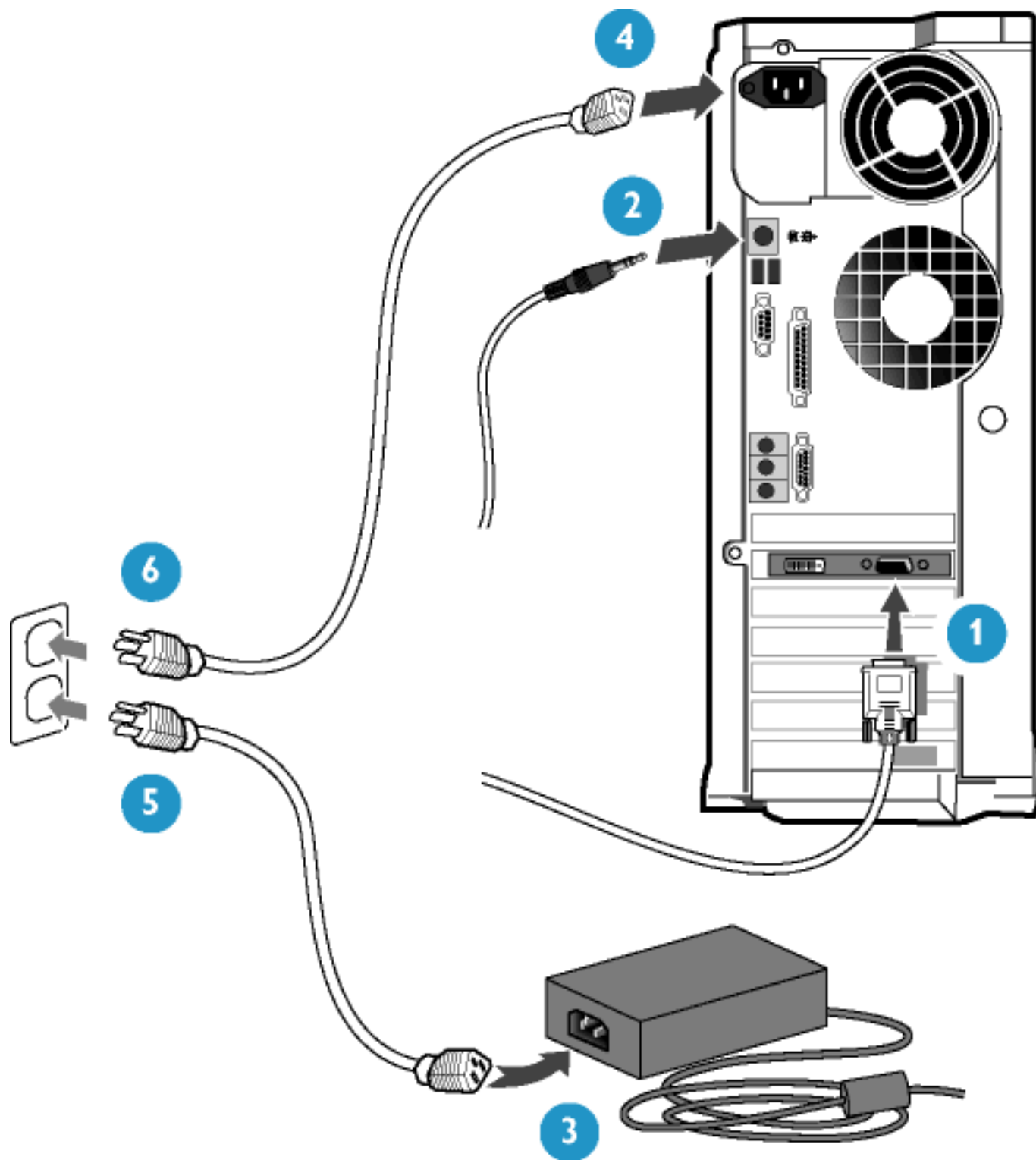

[RETURN TO TOP OF THE PAGE](#)

- Connect to DVD/VCD/VCR

Connect to DVD/VCR/VCD through S-VIDEO

- Connect to DVD/VCR/VCD through S-VIDEO

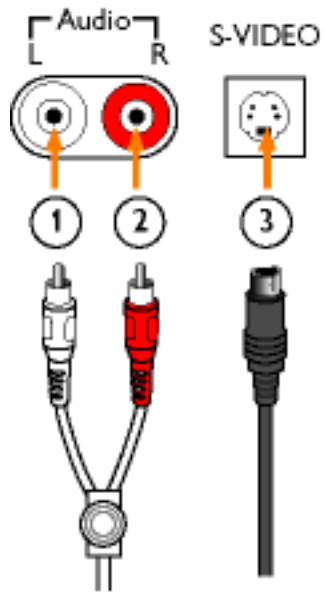

- Connect to DVD/VCR /VCD through SCART (for Europe)

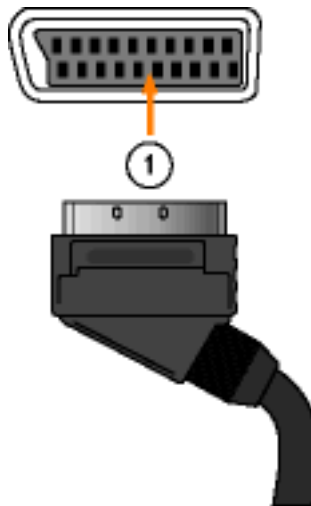

- Connect to DVD/VCR /VCD through composite video (for AP and North America)

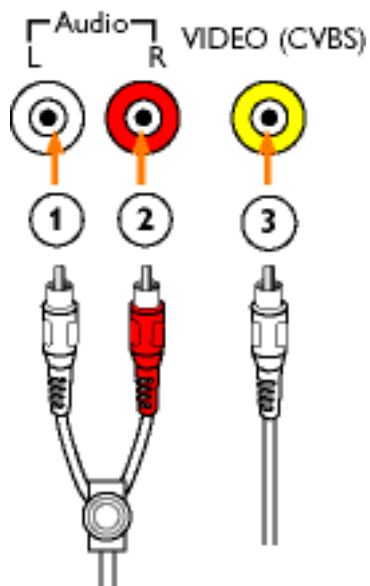

- Connect to DVD/VCR /VCD through component video (for AP and North America)

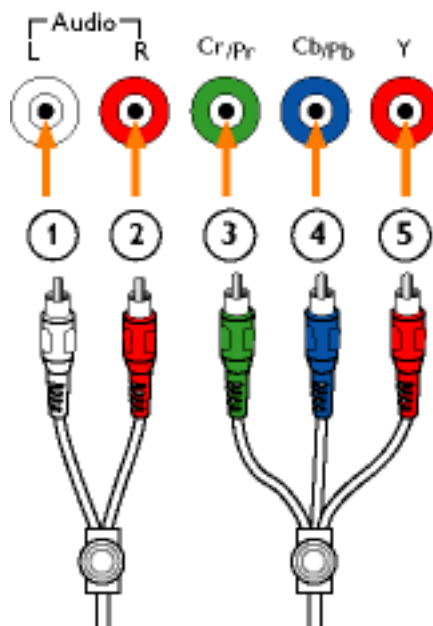

[RETURN TO TOP OF THE PAGE](#)

Removing and Re-installing the Base

[Front View Product Description](#) • [Accessory Pack](#) • [Connecting to Your PC, TV Antenna, DVD/VCR etc.](#) • [Basic Monitor TV Connections](#) • [Getting Started](#) • [Optimising Performance](#)

Removing and Re-installing the Base : [Removing the base](#) • [Re-installing the base](#)

Condition:

- for VESA standard mounting applications
- for optional base replacement

Removing the Base

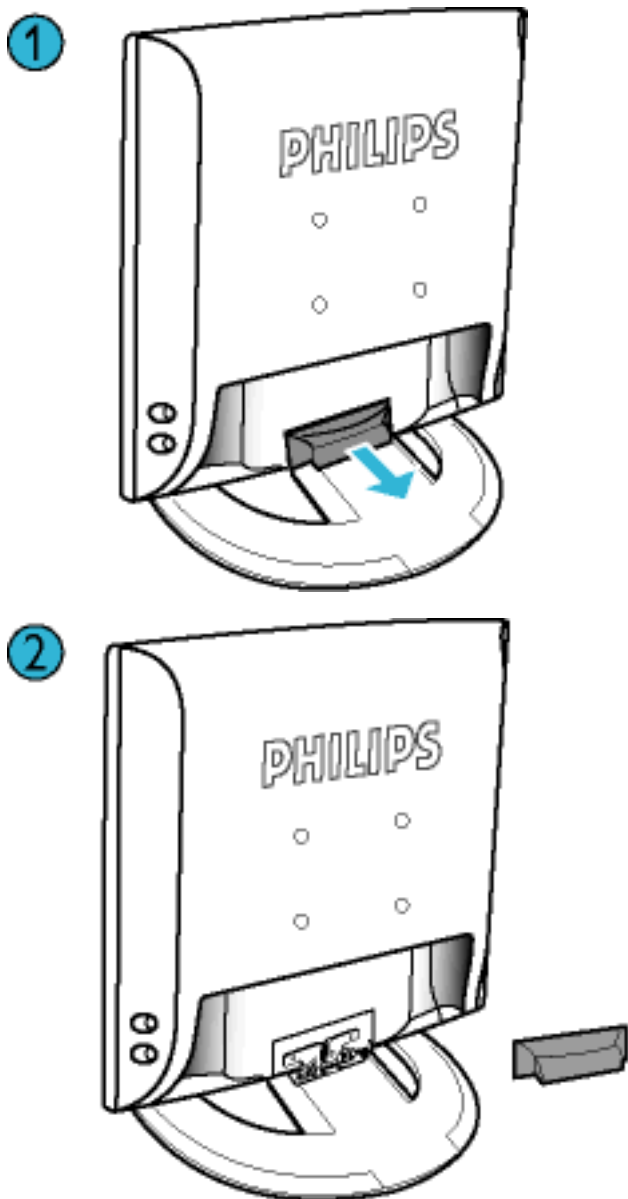

3

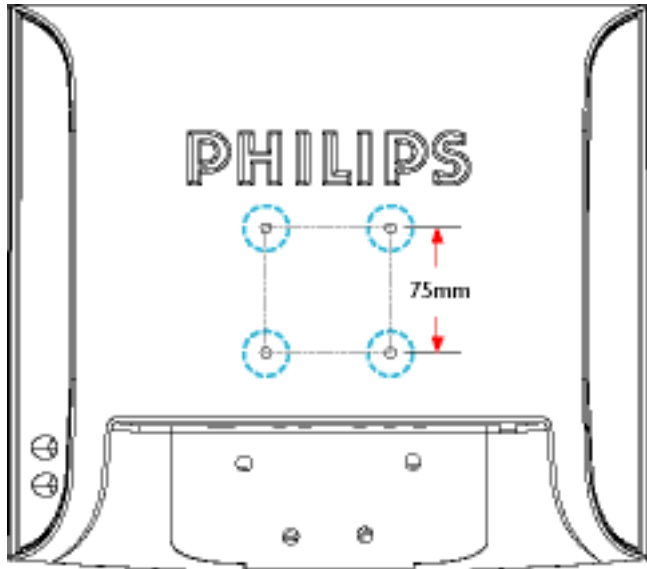
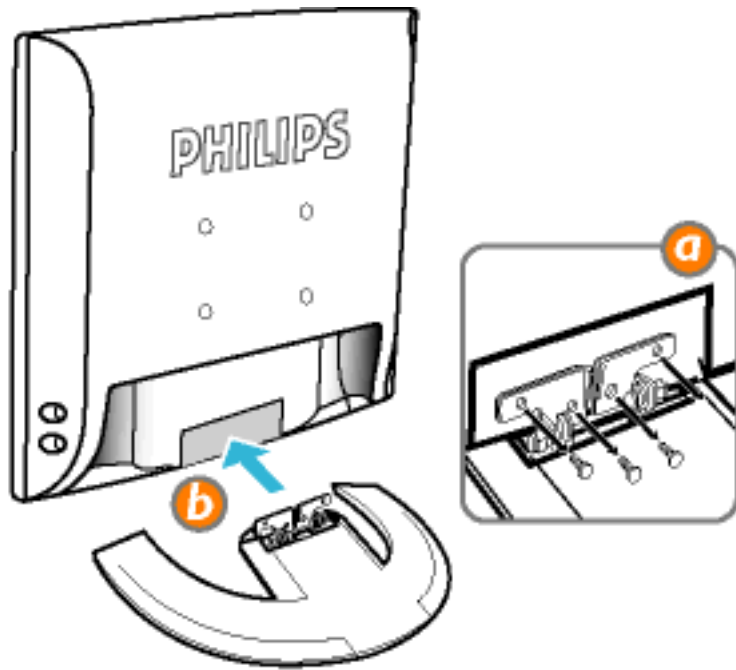

VESA Standard
Holes (75mm x
75mm)

[RETURN TO TOP OF THE PAGE](#)

Re-installing the Base

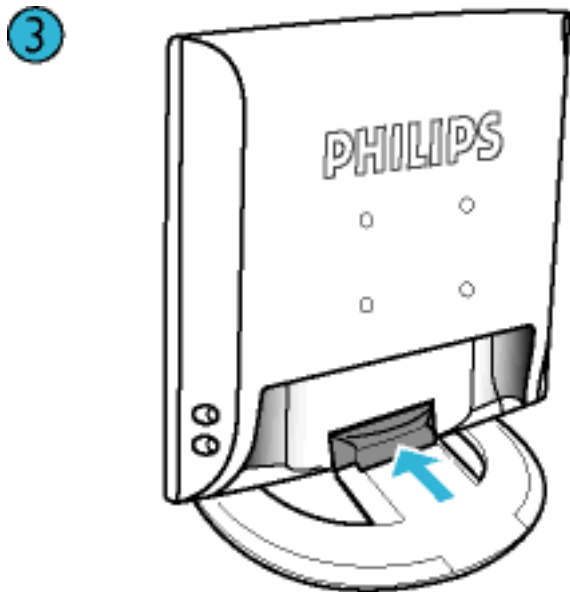
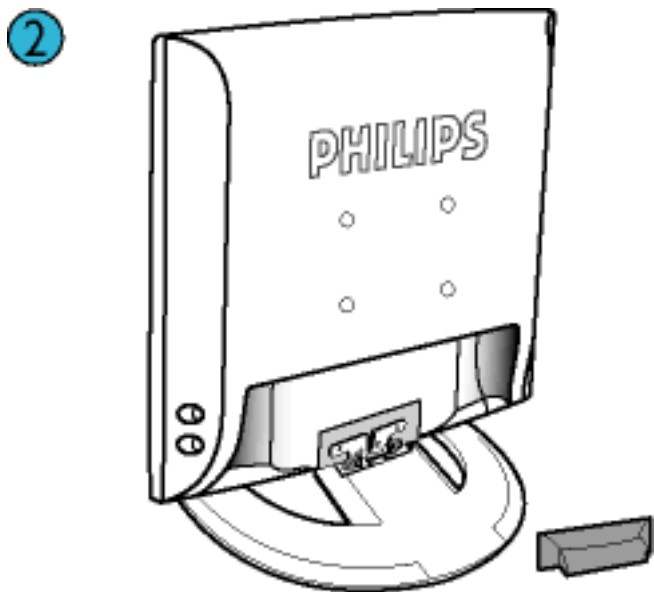
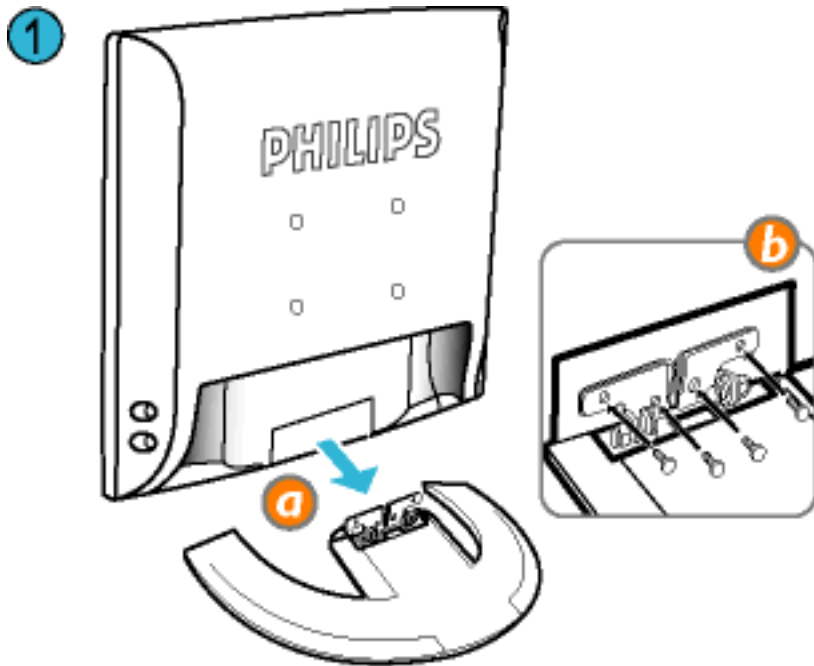

[RETURN TO TOP OF THE PAGE](#)

Basic Monitor/TV Connections

[Front View Product Description](#) • [Connecting to Your PC, TV Antenna, DVD/VCR etc.](#) • [Removing and Re-installing the Base](#) • [Getting Started](#) • [Optimising Performance](#)

Basic Monitor/TV Connections: [Cable TV](#) • [Antenna](#) • [Monitor TV to VCR](#)

Cable TV

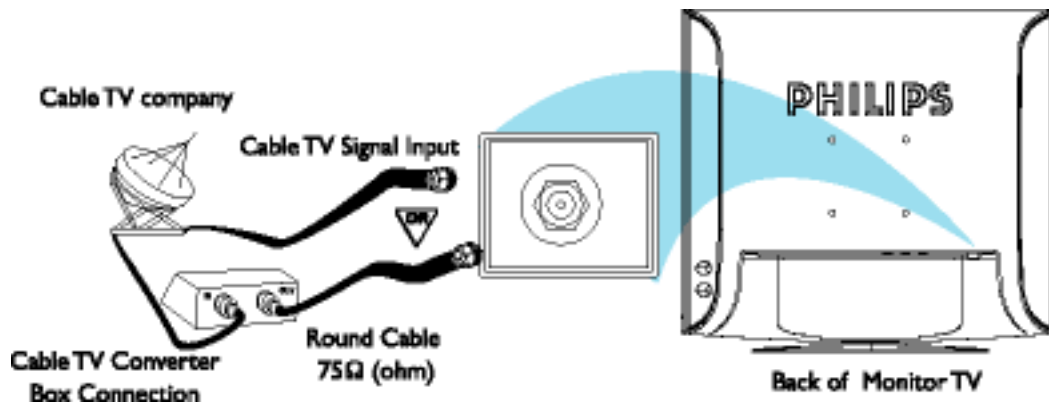

1. If your Cable TV signal is a single, round cable (75 ohm), then you're ready to connect to the TV.
If you have a cable converter box, connect the Cable TV signal to the cable signal IN (put) plug on the converter.
2. Connect the Cable TV cable to the ANTENNA/CABLE plug on the TV. If you have a cable converter box, connect the OUT (put) plug from the converter to the 75 Ω (ohm) plug on the TV.

Note: The connecting cable for the converter is supplied by the Cable TV company.

[RETURN TO TOP OF THE PAGE](#)

Antenna

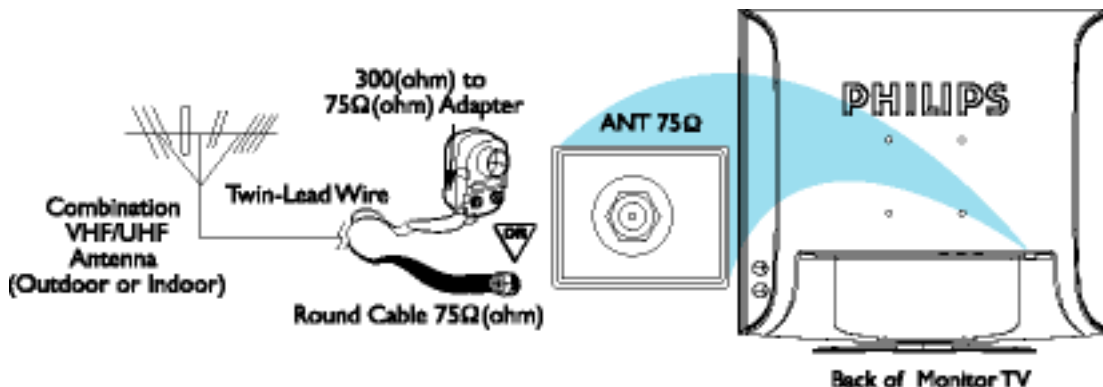

1. If your antenna has a round cable (75 ohm) on the end, then you're ready to connect it to the TV.
If your antenna has flat, twin-lead wire (300 ohm), you first need to attach the antenna wires to the screws on a 300 -to 75- ohm adapter.
2. Push the round end of the adapter (or antenna) onto the 75Ω (ohm) plug on the back of the TV.
If the round end of the antenna wire is threaded, screw it down finger tight.

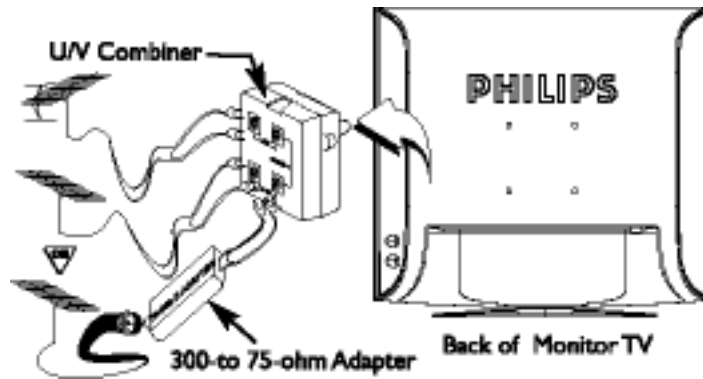

Note: If your home has separate UHF and VHF antennas, you will need an optional combiner to connect to the TV.

[RETURN TO TOP OF THE PAGE](#)

Monitor TV to VCR

BASIC CONNECTION

Follow the steps on the right to connect a basic antenna or Cable TV signal to a VCR, and then the VCR to the TV. For information on other hookups (possible when cable/descrambler boxes are included), refer to the owner's manuals for the VCR and the cable converter.

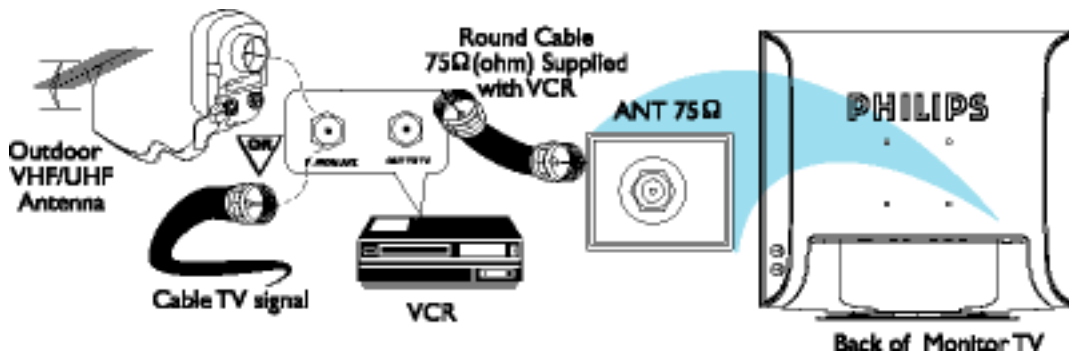

1. Connect your antenna or Cable TV signal to the IN FROM ANT(enna) plug on the VCR.
2. Connect the OUT TO TV plug on the VCR to the 75 ohm plug on the TV (connecting cable supplied with the VCR).
3. Refer to the owner's manual included with your VCR for other possible connections and TV/VCR operating details.

[RETURN TO TOP OF THE PAGE](#)

Getting Started

[Front View Product Description](#) • [Connecting to Your PC, TV Antenna, DVD/VCR etc.](#) • [Removing and Re-installing the Base](#) • [Basic Monitor TV Connections](#) • [Getting Started](#) • [Optimizing Performance](#)

Getting Started

Use the information file (.inf) for Windows 95/98/2000/Me/XP or later

The built-in VESA DDC2B feature in Philips Monitors supports Plug & Play requirements for Windows 95/98/2000/Me/XP. This information file (.inf) should be installed in order that your Philips monitor can be enabled from the 'Monitor' dialog box in Windows 95/98/2000/Me/XP and the Plug & Play application can be activated. The installation procedure based on Windows '95 OEM Release 2 , 98 , Me, XP and 2000 is specified as follows.

For Windows 95

1. Start Windows '95
2. Click on the 'Start' button, point to 'Settings', and then click on 'Control Panel'.
3. Double click on the 'Display' Icon.
4. Select the 'Settings' tab then click on 'Advanced...'
5. Select the 'Monitor' button, point to 'Change...' then click on 'Have Disk...'
6. Click on the 'Browse...' button, select the appropriate drive F: (CD-ROM Drive) then click on the 'OK' button.
7. Click on the 'OK' button then select your monitor model and click on the 'OK'.
8. Click on the 'Close' button.

For Windows 98

1. Start Windows 98
2. Click on the 'Start' button, point to 'Settings', and then click on 'Control Panel'.
3. Double click on the 'Display' Icon.
4. Select the 'Settings' tab then click on 'Advanced...'
5. Select the 'Monitor' button, point to 'Change...' then click on 'Next'
6. Select 'Display a list of all the drivers in a specific location, so you can choose the driver you want.' then click on 'Next' and then click on 'Have Disk...'
7. Click on the 'Browse...' button, select the appropriate drive F: (CD-ROM Drive) then click on the 'OK' button.
8. Click on the 'OK' button then select your monitor model and click on the 'Next' button.
9. Click on the 'Finish' button then the 'Close' button.

For Windows Me

1. Start Windows Me
2. Click on the 'Start' button, point to 'Settings', and then click on 'Control Panel'.
3. Double click on the 'Display' Icon.
4. Select the 'Settings' tab then click on 'Advanced...'
5. Select 'Monitor' button, then click on 'Change...' button.
6. Select 'Specify the location of the driver(Advanced)' and click on the 'Next' button.
7. Select 'Display a list of all the drivers in a specific location, so you can choose the driver you want', then click on 'Next' and then click on 'Have Disk...'
8. Click on 'Browse...' button, select the appropriate drive F: (CD-ROM Drive) then click on the 'OK' button.
9. Click on the 'OK' button, select your monitor model and click on the 'Next' button.
10. Click on 'Finish' button then the 'Close' button.

For Windows 2000

1. Start Windows 2000
2. Click on the 'Start' button, point to 'Settings', and then click on 'Control Panel'.
3. Double click on the 'Display' Icon.
4. Select the 'Settings' tab then click on 'Advanced...'
5. Select 'Monitor'
 - If the 'Properties' button is inactive, it means your monitor is properly configured. Please stop installation.
 - If the 'Properties' button is active. Click on 'Properties' button. Please follow the steps given below.
6. Click on 'Driver' and then click on 'Update Driver...' then click on the 'Next' button.
7. Select 'Display a list of the known drivers for this device so that I can choose a specific driver', then click on 'Next' and then click on 'Have disk...'
8. Click on 'Browse...' button then select the appropriate drive F: (CD-ROM Drive).
9. Click on the 'Open' button, then click on the 'OK' button.
10. Select your monitor model and click on the 'Next' button.
11. Click on the 'Finish' button then the 'Close' button.
If you can see the 'Digital Signature Not Found' window, click on the 'Yes' button.

For Windows XP

1. Start Windows XP
2. Click on the 'Start' button and then click on 'Control Panel'.
3. Select and click on the category 'Printers and Other Hardware'
4. Click on the 'Display' Item.
5. Select the 'Settings' tab then click on the 'Advanced' button.
6. Select 'Monitor' tab
 - If the 'Properties' button is inactive, it means your monitor is properly configured. Please stop installation.
 - If the 'Properties' button is active, click on 'Properties' button.
Please follow the steps below.
7. Click on the 'Driver' tab and then click on 'Update Driver...' button.

8. Select the 'Install from a list or specific location [advanced]' radio button and then click on the 'Next' button.
9. Select the 'Don't Search. I will choose the driver to install' radio button. Then click on the 'Next' button.
10. Click on the 'Have disk...' button, then click on the 'Browse...' button and then select the appropriate drive F: (CD-ROM Drive).
11. Click on the 'Open' button, then click the 'OK' button.
12. Select your monitor model and click on the 'Next' button.
- If you can see the 'has not passed Windows Logo testing to verify its compatibility with Windows XP' message please click on the 'Continue Anyway' button.
13. Click on the 'Finish' button then the 'Close' button.
14. Click on the 'OK' button and then the 'OK' button again to close the Display_Properties dialog box.

If your Windows 95/98/2000/Me/XP version is different or you need more detailed installation information, please refer to Windows 95/98/2000/Me/XP user's manual.

[RETURN TO TOP OF THE PAGE](#)

Using Other Menus (PAL System - Europe)

[Using Your Remote Control](#) • **Using Other Menu:** [PAL System - Asia](#) • [NTSC System](#)

Install: [Choosing a language and country](#) • [Automatic tuning](#) • [Manual tuning](#) • [Programme name](#)

Picture: [Adjusting the picture](#)

Sound: [Adjusting the sound](#)





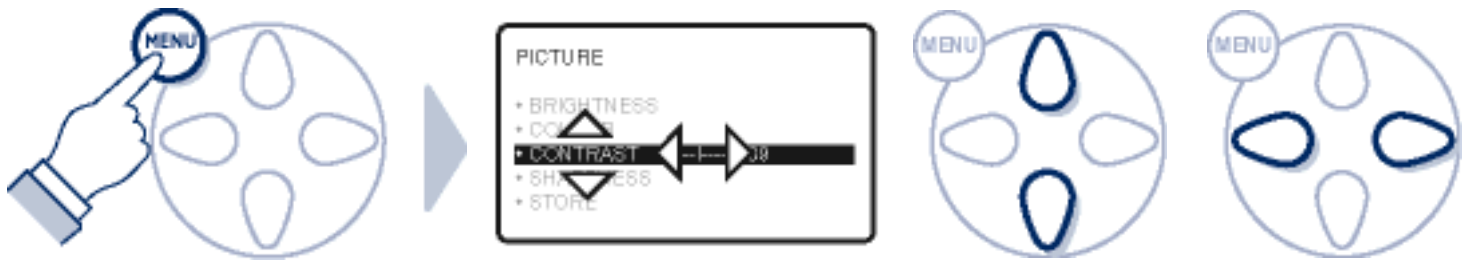





Features: [Timer function](#) • [Locking the set](#)

Using Other Menus (with remote control)



Choosing a language and country



1. Press the MENU key to display the main menu.
2. Select INSTALL , then press . The INSTALL menu appears. The LANGUAGE option is activated.
3. Press  to go into the LANGUAGE menu.
4. Select your language using the  or  key.
The menu will appear in the chosen language.
5. Press  to exit the LANGUAGE menu.
6. Select the option COUNTRY and press .
7. Select your country using the  or  keys.
If your country does not appear in the list, select OTHER.
8. Press  to exit the COUNTRY menu.





9. To exit from the menus, press .

[RETURN TO TOP OF THE PAGE](#)

Automatic tuning

This menu allows you to automatically search for all the programmes available in your region (or on your cable network).



1. First carry out operations 1 to 8 above, then:
2. Press  once to select AUTO STORE then press . The search begins. After several minutes, the INSTALL menu reappears automatically.
3. If the transmitter or the cable network broadcasts the automatic sort signal, the programmes will be correctly numbered.
4. If not, the programmes found will be numbered in descending order starting at 99, 98, 97, etc. Use the SORT menu to renumber them. Some transmitters or cable networks broadcast their own sort parameters (region, languages, etc.). Where this is the case, make your choice using the   keys and confirm with . To exit or interrupt the search, press the MENU key.

5. To exit from the menus, press .

[RETURN TO TOP OF THE PAGE](#)

Manual tuning

This menu allows you to store the programmes one by one.

1. Press MENU.
2. Select INSTALL (0), then press 0. The INSTALL menu appears.
3. Select MANUAL STORE (0) then press 0. The menu appears:



4. Press 0 to go to the SYSTEM menu. Use 00 to choose EUROPE (automatic detection*) or manual detection with WEST EUR (standard BG reception), EAST EUR (standard DK reception), UK (standard I reception) or France (standards LL'). Then press 0 to exit from the menu.
* Except for France (standard LL'): select the option FRANCE.
5. Select SEARCH and press 0. The search begins. As soon as a programme is found, the search will stop. If you know the frequency of the programme required, enter its number directly using the 0, 9 keys and go to step 7.
6. If reception is un-satisfactory, select FINE TUNE and hold down 0 or 0 key.
7. Select PROG. NO (programme number) and use the 00 or 0 to 9 keys to enter the desired number.
8. Select STORE and press 0. The message STORED appears. The programme is stored.
9. Repeat steps 5 to 8 for each programme to be stored.

To exit: press the  key.

[RETURN TO TOP OF THE PAGE](#)

Sorting programmes

1. Press MENU key. The main menu is displayed.
2. Select INSTALL (0), then press 0. The INSTALL menu appears.



3. Using the 0 key, select SORT then press 0. The SORT menu appears. The FROM option is activated.
Note: this menu works as follows: Change 'FROM' (enter the current programme number), 'TO' (enter the new number), 'EXCHANGE numbers' (the operation is carried out).
4. Select the programme you wish to renumber using 0 0 keys or 0 to 9. Example: to renumber programme 78 as 2 press 7, 8.
5. Select TO (using 0 key) and enter the new number using the 0 0 keys or 0 to 9 (for the example given, enter 2).
6. Select EXCHANGE (0 key) and press 0. The message EXCHANGED appears, the exchange takes place. In our example, programme 78 is renumbered as 2 (and programme 2 as 78).
7. Select the option FROM (0 key) and repeat stages 4 to 6 as many times as there are programmes to renumber.
8. To exit from the menus, press .

[RETURN TO TOP OF THE PAGE](#)

Programme name

You may, if you wish, give a name to the first 40 programmes (from 1 to 40).

1. Press MENU.
2. Select INSTALL (0), then press 0. The INSTALL menu appears.
3. Press 5 items to select NAME (concealed at the bottom of the screen,) then press 0. The menu appears:

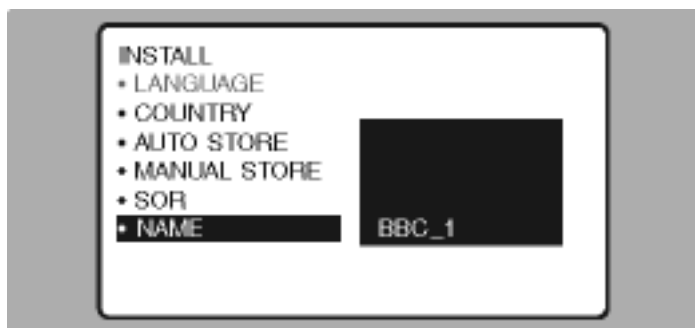

4. Select the programme you wish to name using the keys 0, 9 or - P +.
Note: at the time of installation, the programmes are automatically named when the identification signal is transmitted.
5. Use the 0 0 keys to move within the name display area (5 characters).
6. Use the 0 0 keys to choose the characters.
7. Press MENU when the name has been entered. The programme name is stored.
8. Repeat steps 4 to 7 for each programme to be named.
9. To exit from the menus, press 0.

[RETURN TO TOP OF THE PAGE](#)

Adjusting the picture

1. Press MENU then 0. The PICTURE menu appears:



- Use **0** **0** keys to select a setting and **0** **0** keys to adjust.
Note: the menu is a scroll-down menu.
Keep the **0** key held down to access the settings hidden at the bottom of the screen.
- Once the necessary adjustments have been made, select the STORE option and press **0** to store them.
- To exit from the menus, press **ED**.

Description of the settings:

- **BRIGHTNESS**: alters the brightness of the image.
- **COLOUR**: alters the colour intensity.
- **CONTRAST**: alters the variation between light and dark tones.
- **SHARPNESS**: alters the crispness of the image.
- **STORE**: stores the picture settings.
- **COLOUR TEMP** (colour temperature): adjusts the colour temperature of the picture. Three options are available here: COOL (blue white), NORMAL (balanced) or WARM (red white).
- **INCR.PICTURE** (Incredible Picture): selects the 'ON' option to enhance details in the picture. The result is a more dynamic and vivid picture.

[RETURN TO TOP OF THE PAGE](#)

Adjusting the sound

- Press MENU, select the SOUND option (**0**) and press **0**. The SOUND menu appears:

Description of the settings:

- **TREBLE**: alters the level of the high frequency sound.
- **BASS**: alters the level of the low frequency sound.
- **BALANCE**: to balance the sound between the left and right speakers.
- **DELTA VOLUME** (volume difference) : allows you to compensate for the volume differences between the different programmes or the EXT sockets. This setting is available for

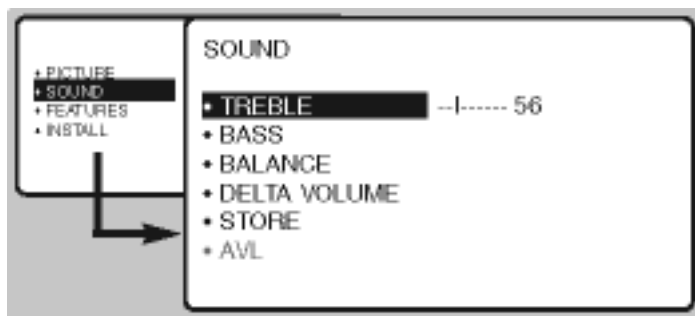

2. Use keys to select a setting and keys to adjust.
Note: to access the AVL setting (hidden at the bottom of the screen) hold down key.
3. Once the necessary adjustments have been made, select the STORE option and press to store them.
4. To exit from the menus, press .

programmes 1- 40 and the EXT sockets.

- STORE: stores the sound settings.
- AVL (Automatic Volume Leveller): automatic volume control used to avoid sudden increases in volume, particularly when changing programmes or during advertisements.
- INCR. SURROUND: The Incredible Surround feature adds greater depth and dimension to both monaural (MONO) and stereo TV sound. When the TV signal is being received in Stereo, press this button for the following options: STEREO, or INCR. SURROUND. When the TV signal is in MONO, the choices displayed will read SPATIAL or MONO.





[RETURN TO TOP OF THE PAGE](#)

Timer function

This menu allows you to use your TV as an alarm clock.

1. Press MENU.
2. Select FEATURES (F), and press  twice. The TIMER menu appears:



3. Press  to enter and exit the sub-menus and use the   keys to adjust:
4. TIME: enter current time.
Note: the time is updated automatically each time the set is switched on using Teletext information taken from programme 1. If programme 1 does not have Teletext, the update will not take place.
5. START TIME: enter the start time.
6. STOP TIME: enter the stop time.
7. PROG; NO;: enter the number of the programme required.
8. ACTIVATE: you can set the alarm to be activated:
ONCE for a one-off alarm,
DAILY for a daily alarm or
OFF to cancel.
9. Press  to set the timer function to standby. It will automatically switch on at the time programmed. If you leave the TV switched on, it will only change programme at the time indicated. The combination of the CHILD LOCK and TIMER functions may be used to limit the length of time your television is in use, for example, by your children.

[RETURN TO TOP OF THE PAGE](#)

Locking the set

You can bar access to certain programmes or completely lock the set by locking the keys.

Locking programmes

1. Press MENU.
2. Select FEATURES (0) and press 0.
3. Select PARENTAL CONT. (0) and press 0.

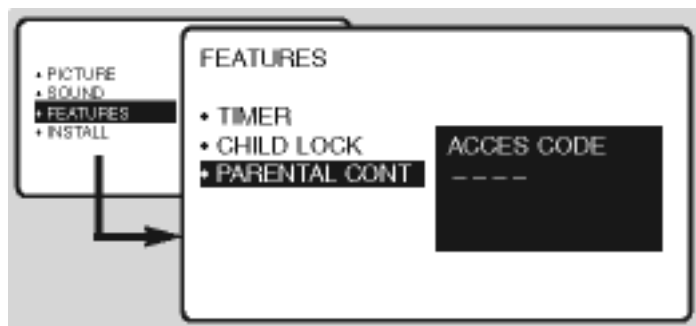

4. Enter your confidential access code. The first time, enter the code 0711 then confirm by re-entering 0711. The menu appears.
5. Press 0 to go into the menu.
6. Use the 00 keys to select the required programme and confirm with 0. The  symbol is displayed alongside the programmes or sockets that have been locked.

7. Press  to exit. To watch a programme which has been locked you will now need to enter the confidential code; otherwise the screen will remain blank. Access to the INSTALL menu is also locked. *Caution: in the case of encrypted programmes which use an external decoder, it is necessary to lock the corresponding EXT socket.*

To unlock all programmes

Repeat stages 1 to 4 above, then select CLEAR ALL and press 0.

To change the confidential code

Repeat stages 1 to 4 above, then:

5. Select CHANGE CODE and enter your own 4-digit number.
6. Confirm by entering it again. Your new code will be stored.
7. Press  to exit from the menus. *If you have forgotten your confidential code, enter the universal code 0711 twice.*

[RETURN TO TOP OF THE PAGE](#)

Using Other Menus (PAL System - Asia)

[Using your Remote Control](#) • **Using Other Menu:** [PAL System - Europe](#) • [NTSC System](#)

Install: [Selecting the Menu Language and Automatic Tuning of Channels](#) • [Manual Tuning of Channels](#)
• [Selecting the Colour/Sound System](#) • [Fine Tuning of Channels](#) • [Sorting of Channels](#) • [Editing of Channels](#)
• [Naming of Channels](#)

Picture/Sound: [Using the Picture/Sound Menu](#)





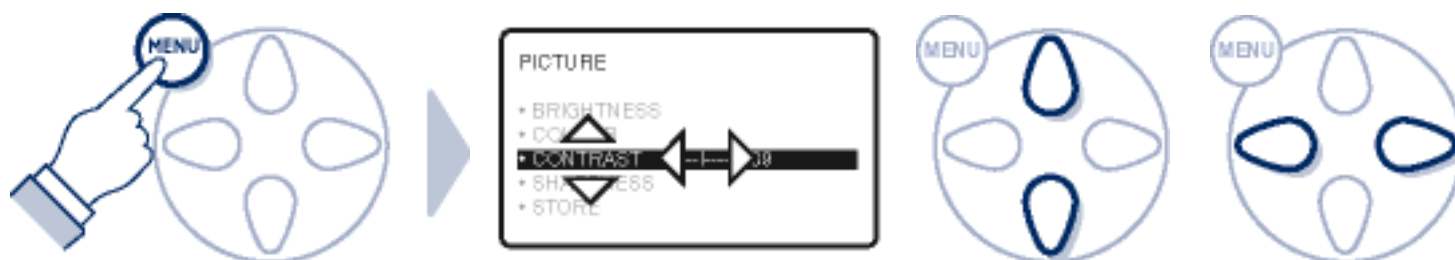



Features: [Timer](#) • [Child Lock \(Access/Change Code\)](#) • [Activating the Child Lock \(Lock Channel\)](#) • [Activating the Child Lock \(Clear All\)](#) • [Using the Programme List Feature](#) • [Smart Picture and Smart Sound Control](#)

Using Other Menus (with remote control)



Selecting the Menu Language and Automatic Tuning of Channels

Before you tune in the channels using the Auto Store method, select the menu language of your choice.

1. Press the MENU key to display the main menu.
2. Press the  button repeatedly until INSTALL is selected.
3. Press the  button to enter INSTALL menu.
4. Press the  button to enter LANGUAGE mode.
5. Select your language with the  or  button.
6. Press the  button to exit the LANGUAGE menu.
7. Press the  button to select AUTO STORE.
8. Press the  button to start automatic tuning.
9. When tuning is completed, press the  button to clear menu from

screen.













[RETURN TO TOP OF THE PAGE](#)

Manual Tuning of Channels

Manual tuning allows you to store each programme manually.



1. Press the MENU key to display the main menu.
2. Press the  button repeatedly until INSTALL is selected.
3. Press the  button to enter INSTALL menu.
4. Press the  button repeatedly until MANUAL STORE is selected.
5. Press the  button to enter MANUAL STORE menu.
6. Press the  button to select SEARCH.
7. Press the  button to start manual tuning of channel. Searching stops once a transmitting channel has been found.
8. Press the  button to select CHANNEL.
9. Key in the desired channel number.
10. Select STORE using the  button.
11. Press the  button to store tuned channel.
Note: If you want to continue searching for another transmitting channel, repeat steps 7 to 11.
12. To exit from the menus, press the  button.







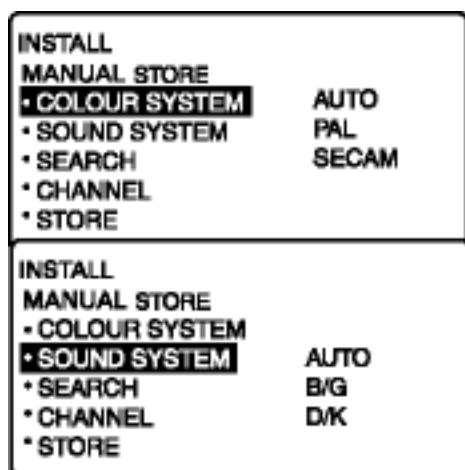





Selecting the Colour/Sound System

This feature allows you to select your desired COLOUR and SOUND system. If AUTO is selected, the respective colour and sound system will be automatically selected in accordance with the transmission system.

Note: Select your desired colour and sound system manually if reception is poor in AUTO mode.













Repeat steps 1 to 5 as in '[Manual Tuning of Channels](#)'.

6. Press the  button. COLOUR SYSTEM is selected. Enter COLOUR SYSTEM mode.
7. Select the desired colour system with the  or  button.
8. Press the  button to exit from colour system mode.
9. Press the  button to select SOUND SYSTEM.
10. Press the  button to enter SOUND SYSTEM mode.
11. Select the desired sound system with the  or  button.
12. Press the  button to exit from sound system mode.
13. Press the  button repeatedly until STORE is selected.
14. Press the  button to store selected system.
15. To exit from the menus, press the  button.

Fine Tuning of Channels

This feature allows you to adjust picture reception in areas of weak reception.



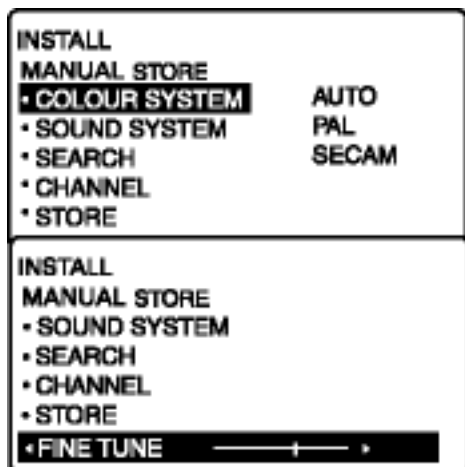



1. Press the MENU key to display the main menu.
2. Press the  button repeatedly until INSTALL is selected.
3. Press the  button to enter INSTALL menu.
4. Press the  button repeatedly until MANUAL STORE is selected.
5. Press the  button to enter MANUAL STORE menu.
6. Press the  button repeatedly until FINE TUNE is selected.
7. Use the  or  button to start fine-tuning until desired picture and sound is obtained.
8. Press the  button to select STORE.
9. Press the  button to store last fine-tuned status.
10. To exit from the menus, press the  button.



[RETURN TO TOP OF THE PAGE](#)

Sorting of Channels

This feature allows you to change the channel number to your choice for a particular TV.

1. Press the MENU key to display the main menu.
2. Press the  button repeatedly until INSTALL is selected.
3. Press the  button to enter INSTALL menu.
4. Press the  button repeatedly until SORT is selected.
5. Press the  button to enter SORT menu.
6. Key in the channel number in the FROM column, i.e. the channel you want to swap from.
7. Press the  button to select TO.
8. Key in the channel number in the TO column, i.e. the channel you want to swap to.
9. Press the  button to select EXCHANGE.
10. Press the  button to activate exchange of channels.





11. To exit from the menus, press the  button.







[RETURN TO TOP OF THE PAGE](#)

Editing of Channels





This feature allows you to edit or skip channels which have a poor or weak TV signal or channels that you do not watch often.

Note: Once a channel has been skipped, you cannot access it via the CHANNEL + or - button. You can only access the channel using the DIGIT (0-9) button.

1. Press the MENU key to display the main menu.
2. Press the  button repeatedly until INSTALL is selected.
3. Press the  button to enter INSTALL menu.

4. Press the  button repeatedly until CHANNEL EDIT is selected.
5. Press the  button to enter channel edit mode.
6. Press the  or  button to select the channel you want to skip.
7. Press the  button to activate skipped mode.
8. To exit from the menus, press the  button.

How to add channels again:











- Repeat steps 1 to 5 as in 'Editing of Channels'.
- Select the channel you want to add using the  or  button.
- Press the  button to activate the inclusion of channel.
- Clear the menu from the screen using the  button.



[RETURN TO TOP OF THE PAGE](#)

Naming of Channels

This feature allows you to select 10 predefined channels. It also allows you to enter a new name or modify the existing name of a channel for 40 channels, including external channels.

1. Press the MENU key to display the main menu.
2. Press the  button repeatedly until INSTALL is selected.
3. Press the  button to enter INSTALL menu.
4. Press the  button repeatedly until NAME is selected.
5. Press the  button to enter NAME mode.
6. Press the  or  button to select the desired preset name and press the  button to store selected preset name.
7. If you select PERSONAL, move to first character slot using the  button.
8. Press the  or  button repeatedly to run through the characters and select desired character. Move to the next character slot using the  button and select the next character.

(You can enter up to a maximum of 5 characters)



9. Press the MENU button to store named channel.
10. To exit from the menus, press the  button.



[RETURN TO TOP OF THE PAGE](#)

Using the Picture/Sound Menu

The picture and sound menu allows you to make adjustments to the picture and sound. It also allow you to select and activate other features in the menu.

1. Press the MENU key to display the main menu.
2. Press the  button repeatedly until INSTALL is selected.
3. Press the  button to enter INSTALL menu.

Description of the picture settings:

- **BRIGHTNESS:** Increase or decrease brightness level.
- **COLOUR:** Increase or decrease colour level.
- **CONTRAST:** Increase or decrease contrast level until lightest parts of the picture show detail effectively.
- **SHARPNESS:** Increase or decrease sharpness level to improve detail in the picture.
- **COLOUR TEMP:** Allows you a choice of 3 picture settings (NORMAL, WARM and COOL).
- **NR (Noise Reduction):** Allows you to reduce the 'noise' (little dots on the picture) from weak signal broadcast. Selecting the 'ON' option will make the picture clearer.

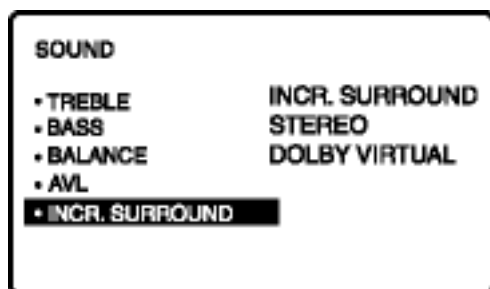
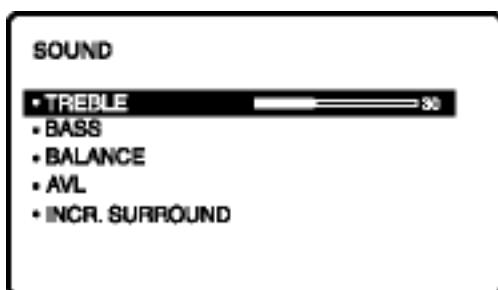
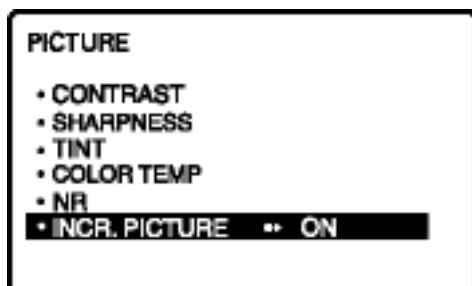
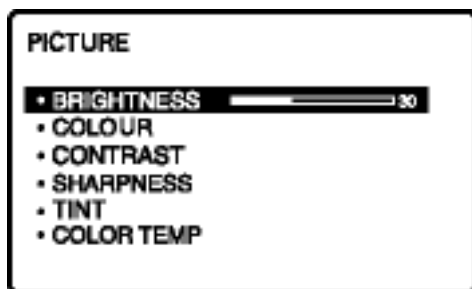

- **INCREDIBLE PICTURE:** Selecting the 'ON' option enhances the detail in the picture. The result is a more dynamic and vivid picture.

Note: HUE feature is only applicable to NTSC programmes. The HUE item will not appear on the menu if the programme is in PAL mode.

Description of the sound settings:

- **TREBLE:** Increase or decrease the high frequency level.
- **BASS:** Increase or decrease the low frequency level.
- **BALANCE:** Adjusts the balance of the right and left speakers.
- **AVL (Auto Volume Leveller):** As variation in signal conditions can result in a sudden change in volume during commercial breaks or when the channel is changed, select the 'ON' function to maintain a standard volume level.
- **INCREDIBLE SURROUND:** When there is Stereo transmission, this button can be pressed to select Incredible Surround, Stereo or Dolby Virtual. When transmission is in Mono, it will display Mono or Spatial.

[RETURN TO TOP OF THE PAGE](#)

Using Other Menus (NTSC System)

[Using Your Remote Control](#) • **Using Other Menu:** [PAL System - Europe](#) • [PAL System - Asia](#)

Install: [Language](#) • [Tuner](#) • [Auto Programme](#) • [Manual](#) • [Channel Edit](#) • [Name](#)

Picture: [Adjusting the Picture](#)

Sound: [Adjusting the Sound](#)

Features: [The Timer](#) • [The AutoLock™](#) • [The Closed Captioning Control](#)

Using Other Menus (with remote control)

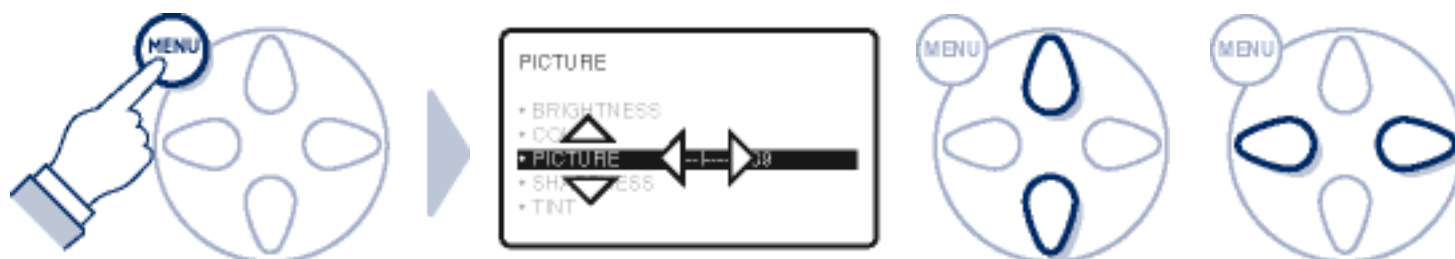

Language

1. Press the PC/TV button on the remote control to 'TV' mode.
2. Press the MENU button on the remote control to show the on-screen menu.
3. Press repeatedly until INSTALL is highlighted.
4. Press to shift the menu to the left and highlight LANGUAGE.
5. Press to highlight the LANGUAGE control option.
6. Press or to select ENGLISH, ESPANOL (Spanish), or FRANCAIS (French).
7. Press the MENU button repeatedly to clear the menu from the screen.

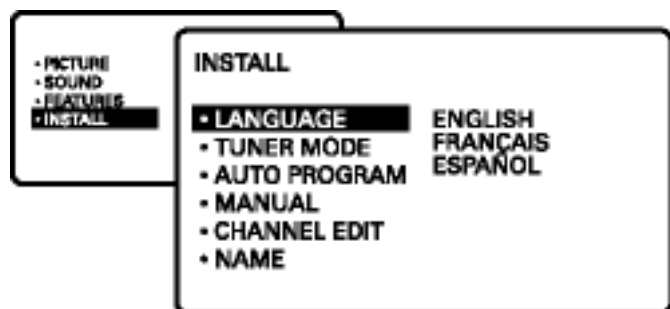



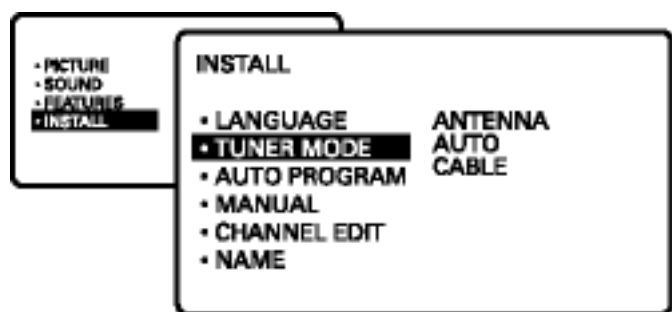

[RETURN TO TOP OF THE PAGE](#)

Tuner

1. Press the MENU button on the remote control to show the on-screen menu.
2. Press  repeatedly until INSTALL is highlighted.







3. Press  to shift the menu to the left.
4. Press  once to highlight the TUNER MODE.
5. Press  to highlight the tuner option.
6. With the TUNER MODE set to AUTO, Auto Program (see left) will detect whether or not cable input is present. If, however, you want to set the TUNER MODE to CABLE or ANTENNA, press  or  until either CABLE or ANTENNA is highlighted.
7. Press the MENU button repeatedly to clear the menu from the screen.

Smart Help

When CABLE is selected, channels 1-125 are available. When ANTENNA is selected, channels 2-69 are available.

[RETURN TO TOP OF THE PAGE](#)

Auto Program

1. Press the MENU button on the remote control to show the on-screen menu.
2. Press  repeatedly until INSTALL is highlighted.
3. Press  to shift the menu to the left. LANGUAGE will be highlighted.
4. Press  repeatedly until the AUTO PROGRAM control is highlighted.
5. Press  to start the Auto Program scanning of channels.
6. Press the MENU button repeatedly to

clear the menu from the screen.

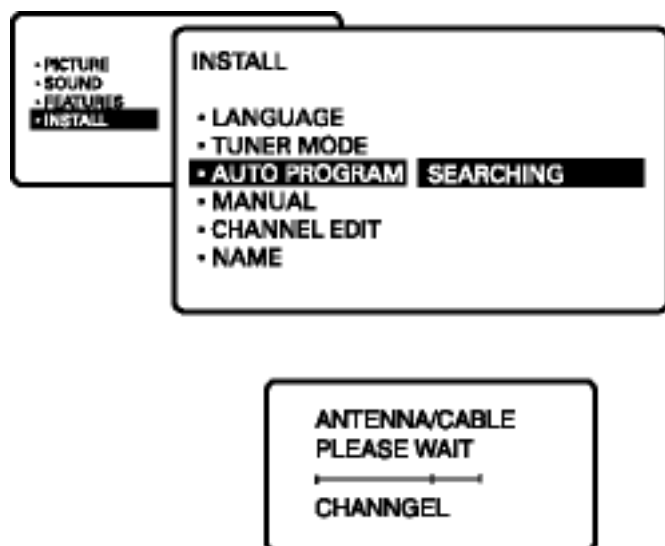

Smart Help

After you've run Auto Program, check the results. Press the CHANNEL (+) or (-) button and see which channels you can select.

Remember an antenna or Cable TV signal must be connected to your Monitor TV first (see the ['Basic Monitor TV connection'](#) section)

If you want to delete any unwanted channels from the memory of the Monitor TV, see the ['Channel Edit'](#) section.

[RETURN TO TOP OF THE PAGE](#)

Manual

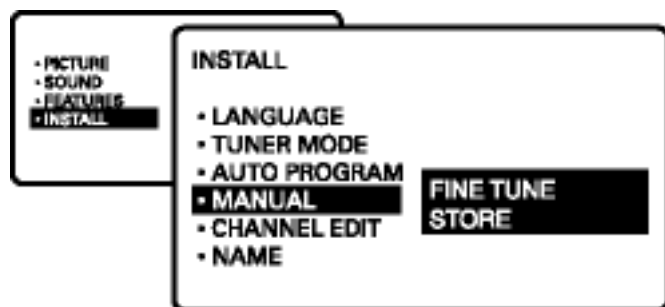

The Fine Tuning feature allows you to adjust picture reception in an area of poor reception.







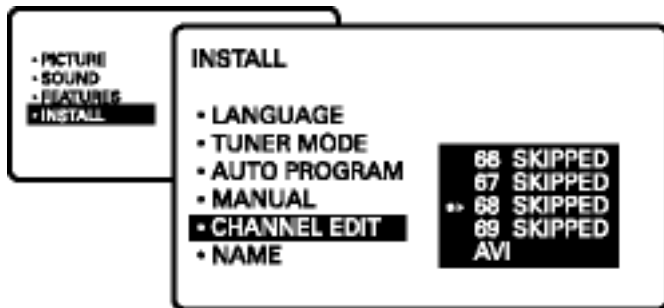

1. Press the MENU button on the remote control to show the on-screen menu.
2. Press repeatedly until INSTALL is highlighted.
3. Press to shift the menu to the left.
4. Press repeatedly until MANUAL is highlighted.
5. Press to shift the menu to the left. FINE TUNE is highlighted.
6. Press to start fine-tuning. Fine-tune the channel until the desired picture and sound is obtained.
7. Press to highlight STORE.
8. Press to store the last fine-tuned status.
9. Press the MENU button to clear the menu from the screen or wait for the on-screen menu to time out and disappear from screen.

[RETURN TO TOP OF THE PAGE](#)



Channel Edit

1. Press the MENU button on the remote control to show the on-screen menu.
2. Press  repeatedly until INSTALL is highlighted.
3. Press  to shift the menu to the left. LANGUAGE will be highlighted.











4. Press  repeatedly until CHANNEL EDIT control is highlighted.
5. Press  to access the CHANNEL EDIT menu.
6. Press  or  to scroll through the list of available channel or press number buttons on your remote control to select a specific channel (for example, press 0 and then 2 to select channel 2).
7. With the channel you want to edit selected, press  to mark the channel as SKIPPED.

The channel you've marked SKIPPED will not appear when you are changing from channel to channel while watching TV.

NOTE: When you want to add a channel that has been market SKIPPED, press  or  to highlight the channel: then press  to remove the word SKIPPED.

[RETURN TO TOP OF THE PAGE](#)

Name

1. Press the MENU button on the remote control to show the on-screen menu.
2. Press  repeatedly until INSTALL is highlighted.
3. Press  to shift the menu to the left. LANGUAGE will be highlighted.
4. Press  repeatedly until NAME control is highlighted.
5. Press  to highlight the NAME option area.
6. Press  or  repeatedly to run through the list of preset names and select desired preset name.
7. If you select PERSONAL, press  then press  to scroll through a list of options for the first character (A to Z, 0 to 9).

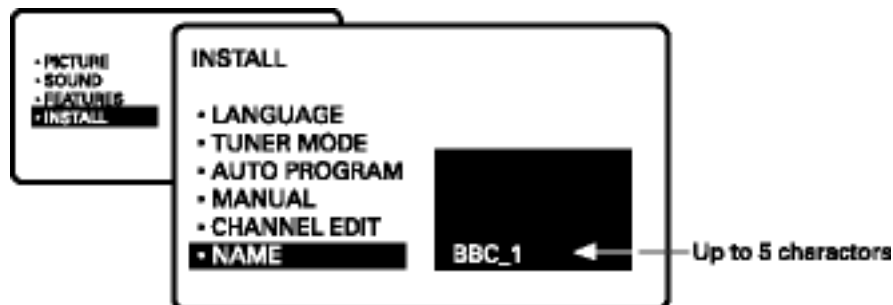

Press  and repeat for the second, third, fourth and fifth characters.

8. After you have selected a name for the channel, press the MENU button to save the name in the TV's memory.
9. Press MENU button repeatedly to clear the menu from the screen.

Smart Help

The five characters that you can enter for the channel NAME features can be letters, a dash character, a space or any number from 0 to 9.

[RETURN TO TOP OF THE PAGE](#)





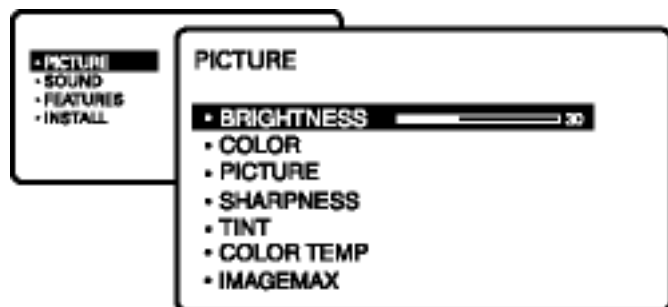

Adjusting the Picture

1. Press the MENU button on the remote control to show the on-screen menu. PICTURE will be highlighted.
2. Press  and the menu will shift to the left. BRIGHTNESS will be highlighted and an adjustment bar will be shown to the right.



Remember, when the bar scale is centred , the control settings are at normal, mid-range levels. Picture adjustments are described here.

- **BRIGHTNESS:** adds or subtracts light from the darkest part of the picture.
- **COLOR:** adds or eliminates colour.
- **PICTURE:** improves the detail of the lightest parts of the picture.
- **SHARPNESS:** improves the detail in the picture.
- **TINT:** adjusts the picture to obtain natural skin tones.
- **COLOR TEMP:** offers NORMAL, COOL or WARM picture preferences.
NORMAL: keeps whites, white.

3. Use  or  keys to adjust the BRIGHTNESS level of the picture.
4. After adjusting the BRIGHTNESS control, press  to select another picture adjustment: COLOR, PICTURE, SHARPNESS, TINT, COLOR TEMP or IMAGEMAX. Press  or  to adjust the selected control.
Note: The menu will show only five items at a time, so you will need to continue scrolling with  to adjust the COLOR TEMP and IMAGEMAX.
5. Press the MENU button repeatedly to clear the menu from the screen.

COOL: makes whites, bluish.
WARM: makes whites, reddish.

- IMAGEMAX™: helps you sharpen the picture quality by making dark areas of the picture darker and light areas of the picture brighter.

[RETURN TO TOP OF THE PAGE](#)

Adjusting the Sound

Besides the normal volume level control, your TV also has individual sound-adjustment controls.

1. Press the MENU button on the remote control to show the on-screen menu.
2. Press  once to highlight SOUND.

- TREBLE, BASS and BALANCE: The TREBLE (high frequency), BASS (low frequency), and Speaker BALANCE may all be used to adjust the sound playback of TV programmes.
- AVL (Audio Volume Leveler): When the AVL control turned ON, the TV is able to level out the sound that is being heard. This makes for a more consistent sound by reducing the peaks and valleys that occur during program changes or commercial breaks.
- INCR. SURROUND: The Incredible Surround feature adds greater depth and dimension to both monaural (MONO) and stereo TV sound. When the TV signal is being received in Stereo, press this button for the following options: STEREO, or INCR. SURROUND. When the TV signal is in MONO, the choices displayed will

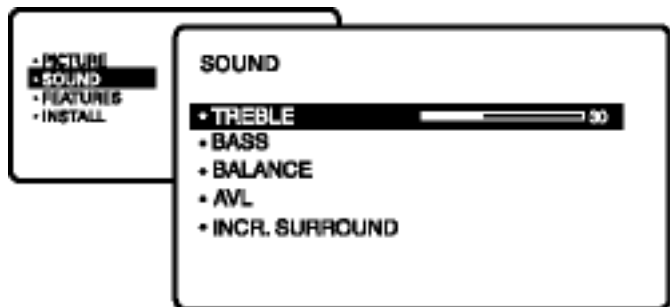

3. Press and the menu will shift to the left. TREBLE will be highlighted and an adjustment bar will be shown to the right.
4. Use or to adjust the TREBLE (high frequency) level of the television sound.
5. After adjusting the TREBLE control, press to select another sound adjustment: BASS, BALANCE AVL, INCR. SURROUND, STEREO, SAP or SPEAKERS. Press or to adjust the selected control.
6. Press the MENU button repeatedly to clear the menu from the screen.

Smart Help

Remember, when the bar scale is centred, speaker BALANCE is centred between left and right side speakers.

read SPATIAL or MONO.

- STEREO: When STEREO has been selected, the television will reproduce any stereo broadcast signal it receives.
- SAP: An SAP is an additional part of the stereo broadcast system. Sent as a third audio channel, an SAP can be heard apart from the current TV programme sound. If an SAP signal is not present with a selected programme, the SAP option cannot be selected. If SAP is selected on a channel (with SAP) and you select another channel, when you return to the original channel, SAP will be OFF. You will have to reselect the SAP feature.
- SPEAKERS: Would you like to hear TV programmes through your audio hi-fi system? The TV's Audio Output jacks and TV Speaker ON/OFF control work together to offer you this TV sound option.

[RETURN TO TOP OF THE PAGE](#)

Using Other Menus (PAL System - Asia)

[Using Your Remote Control](#) • **Using Other Menu:** [PAL System - Europe](#) • [NTSC System](#)

Install: [Selecting the Menu Language and Automatic Tuning of Channels](#) • [Manual Tuning of Channels](#)
• [Selecting the Colour/Sound System](#) • [Fine Tuning of Channels](#) • [Sorting of Channels](#) • [Editing of Channels](#)
• [Naming of Channels](#)

Picture/Sound: [Using the Picture/Sound Menu](#)

Features: [Activating the Timer](#) • [Activating the Child Lock \(Access/Change Code\)](#) • [Activating the Child Lock \(Lock Channel\)](#) • [Activating the Child Lock \(Clear All\)](#) • [Using the Programme List Feature](#) • [Smart Picture and Smart Sound Control](#)

Using Other Menus (with remote control)

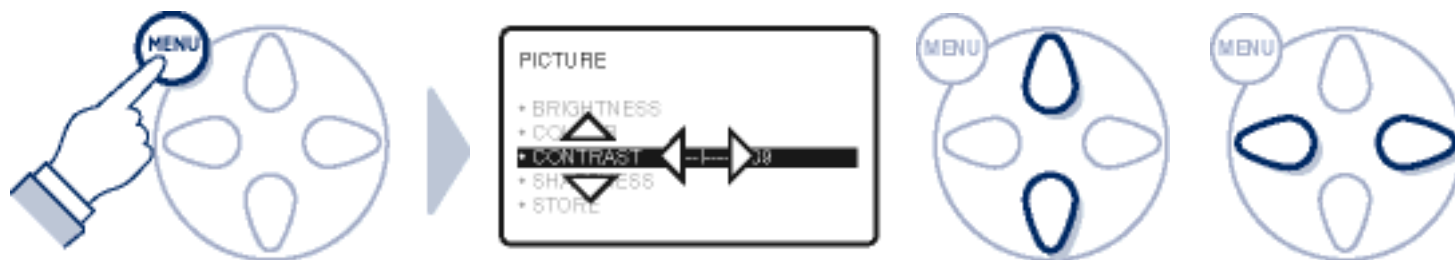







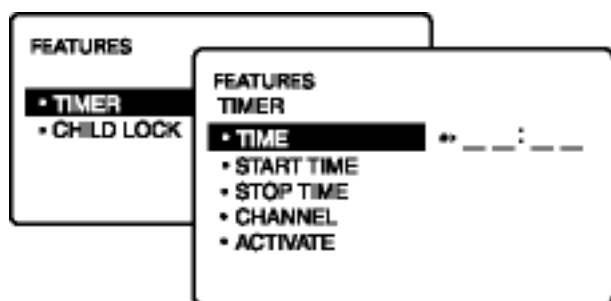





Activating the Timer

The Timer feature allows you to set the timer to switch to another channel at a specified time while you are watching another channel or when the TV is in standby mode.

Note: For the timer to function, the set must not be switched off. If the set is switched off, the timer will be disabled.



7. Key in the time you want the programme to be switched on.
8. Press MENU to exit from START TIME mode.
9. Press the  button to select STOP TIME.
10. Press the  button to enter STOP TIME mode.
11. Key in the time you want the programme to be switched off.
12. Press MENU to exit from STOP TIME mode.
13. Press the  button to select CHANNEL.
14. Key in the channel you want to switch to.
15. Press the  button to select ACTIVATE.

1. Press the  button to enter TIMER menu.
2. Press the  button to enter TIME mode.
3. Key in the current time. For example, if the current time is 12:30, key digit 1 and 2 in the hour column, followed by digit 3 and 0 in the minute column.
4. Press MENU to exit from TIME mode.
5. Press the  button to select START TIME.
6. Press the  button to enter the START TIME mode.
16. Press the  button to activate timer. You can select to activate timer by DAILY or ONCE mode.
17. Press the  button to select DISPLAY.
18. Press the  button to select ON mode if you want to display the current time on the TV screen.
19. To exit from the menus, press the  button.







Note: 30 seconds before the timer is activated, a message indicating the time left for the channel switch will appear on the screen. To disable the channel switch, press any button on the remote control.

[RETURN TO TOP OF THE PAGE](#)

Activating the Child Lock (Access Code/Change Code)

The Child Lock feature allows you to lock channels to prevent your children from watching programmes you consider undesirable.

Note: You cannot access the locked channels via the front controls of the TV set. You can only access to the locked channels via the remote control. Keep the remote control out of reach so as to prevent your children from having access to it.

1. Press the MENU key to display the main menu.
2. Press the  button repeatedly until FEATURES is selected.
3. Press the  button to enter FEATURES menu.
4. Press the  button to select CHILD LOCK.
5. Press the  button to enter ACCESS CODE mode.
6. Key in access code 0711 (0711 is the default access code). The message INCORRECT will appear.
7. Key in 0711 a second time. When the message CORRECT appears, the CHILD LOCK menu will be accessible. You can now proceed to change the access code of your choice.
8. Press the  button to select CHANGE CODE.
9. Press the  button to enter CHANGE CODE mode.
10. Key in the access code of your choice.
11. Confirm access code.

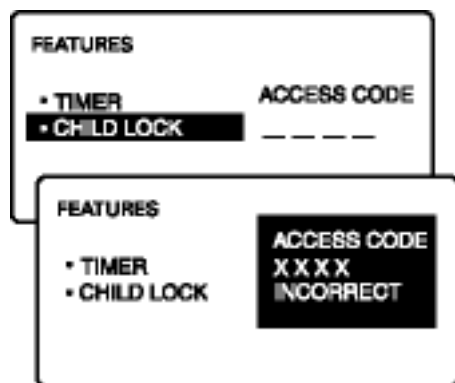

When the new code is confirmed, the message CORRECT will appear.

- To exit from the menus, press the









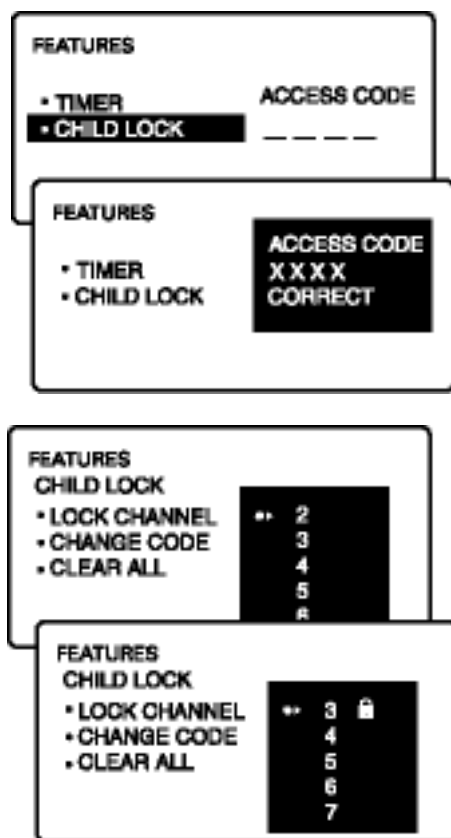

Note: After you have cleared the menu from screen and you want to enter child lock menu again, you only need to key in the new access code once. If you have forgotten the new access code, key in 0711 twice to enter the child lock menu. Upon entering the child lock menu, you can proceed to change code again.

[RETURN TO TOP OF THE PAGE](#)

Activating the Child Lock (Lock Channel)









- Press the MENU key to display the main menu.
- Press the  button repeatedly until FEATURES is selected.
- Press the  button to enter FEATURES menu.
- Press the  button to select CHILD LOCK.
- Press the  button to enter ACCESS CODE mode.
- Key in access code.
- Press the  button to enter LOCK CHANNEL mode.
- Select the channel you want to block using the  or  button.
- Activate blocking of channel. A key lock symbol will appear beside the channel number to indicate that it is locked.
- To exit from the menus, press the  button.

Note: You cannot access the locked channels via the front controls of the TV set. You can only access the locked channels via the remote control. When AVI source is locked, the CVI source is automatically locked. Similarly, if the CVI source is locked, the AVI source is also automatically locked because they share the same audio input.

If you attempt to enter the INSTALL menu after locking a channel, a message 'Enter ACCESS CODE' will appear on the screen. You must enter the ACCESS CODE to enable you to enter the INSTALL menu.



[RETURN TO TOP OF THE PAGE](#)

Activating the Child Lock (Clear All)

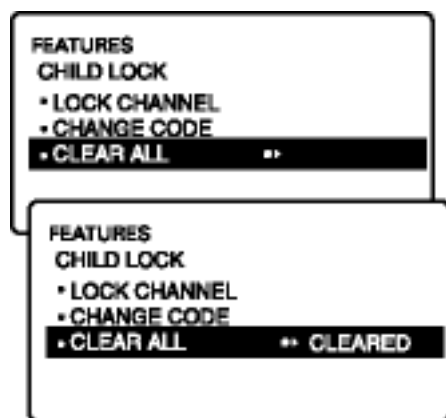
1. Press the MENU key to display the main menu.
2. Press the  button repeatedly until FEATURES is selected.
3. Press the  button to enter FEATURES menu.
4. Press the  button to select CHILD LOCK.
5. Press the  button to enter ACCESS CODE mode.
6. Key in access code.
7. Press the  button repeatedly until CLEAR ALL is selected.
8. Press the  button to activate clearing of all locked channels.
9. To exit from the menus, press the  button.



Note: You can also unlock individual channel via the LOCK CHANNEL menu.





- Repeat step 1 to 7 in 'ACTIVATING THE CHILD LOCK (LOCK CHANNEL)'.
● Select the channel you want to unlock using the  or  button.
- Press the  button to unlock channel (the key lock symbol will disappear).

[RETURN TO TOP OF THE PAGE](#)

Using the Programme List Feature

The programme listing feature allows you to navigate through a list of installed programmes to gain a quick overview of the channels and activate the channel you have selected.





1. Press the  (PROGRAM LIST) button to display the list of installed programmes. The current channel is highlighted.
2. Press the  or  button to run through the programme list and highlight the channel number you want to activate.
3. Press the  button to activate the channel you have selected.
4. Press the  button to clear the menu from screen.

[RETURN TO TOP OF THE PAGE](#)

Smart Picture and Smart Sound Control

SMART PICTURE feature offers you a choice of 5 picture settings: RICH, NATURAL, SOFT, PERSONAL and MULTIMEDIA.

SMART SOUND feature offers you a choice of 4 sound settings: THEATRE, MUSIC, VOICE and PERSONAL.

Press  or  button (see [Using Your Remote Control](#)) repeatedly to run through the settings to select your desired mode.

Definition of Picture Settings

PERSONAL	Picture settings are set to your preference.
RICH	Emphasizes very vibrant colours. (Suitable for AV mode in brightly-lit room)
NATURAL	Emphasizes original colours.
SOFT	Emphasizes 'warm' colours. (Suitable for dimly-lit room and gives cinema-like effect when light is switched off).
MULTIMEDIA	Emphasizes 'soft' colours. (Suitable for playing computer games, surfing, etc.)
<p><i>Note: The PERSONAL setting is the setting that you set up using the Picture menu in the main menu. This is the only setting in the Smart Picture settings that can be changed. All the other settings are preset at the factory.</i></p>	

Definition of Sound Settings

PERSONAL	Sound settings are set to your preference.
VOICE	Emphasizes high tone. (Treble boosted)
MUSIC	Emphasizes low tone. (Bass boosted)
THEATRE	Emphasizes sensation of action. (Bass and Treble boosted)

[RETURN TO TOP OF THE PAGE](#)

Using Other Menus (NTSC System)

[Using your Remote Control](#) • **Using Other Menu:** [PAL System - Europe](#) • [PAL System - Asia](#)

Install: [Language](#) • [Tuner](#) • [Auto Program](#) • [Manual](#) • [Channel Edit](#) • [Name](#)

Picture: [Adjusting the Picture](#)

Sound: [Adjusting the Sound](#)

Features: [The Timer](#) • [The AutoLock™](#) • [The Closed Captioning Control](#)

Setting the Clock

Your television comes with an on-screen clock. During normal operation, the clock appears on the screen when the TIMER DISPLAY control is turned ON.

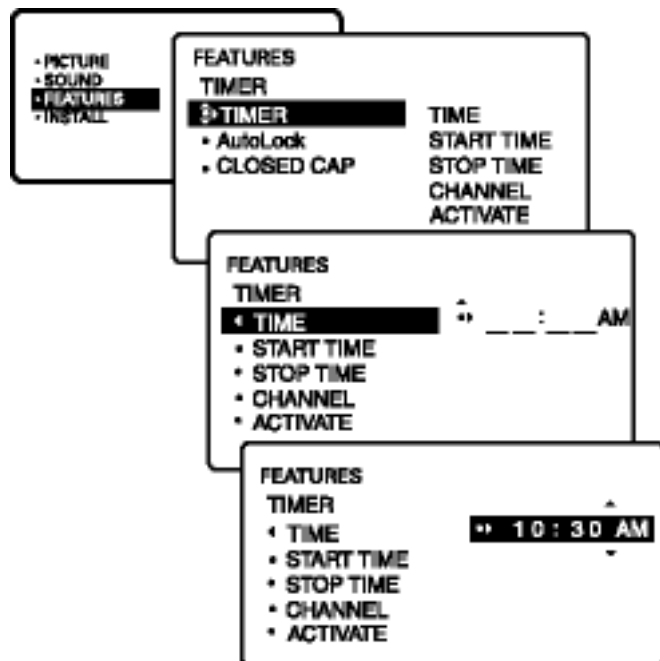

1. Press the MENU button on the remote control to show the on-screen menu.
2. Press twice to highlight FEATURES.
3. Press and the menu will shift to the left. TIMER will be highlighted.
4. With TIMER selected, press again to shift the display left and highlight the TIME control.
5. Press again to highlight the time indicator area.
6. Press or to select the position or digit you wish to enter.
7. Press or to select the digits for the time or press the NUMBERED buttons to enter the correct time.
8. Press to move to the AM or PM position.
9. Press or to set AM or PM.
10. Press the MENU button repeatedly to clear the menu from the screen.

[RETURN TO TOP OF THE PAGE](#)

Setting the Start Time

Just as you would an alarm clock, you can set the TV to turn itself ON once or at the same time every day.

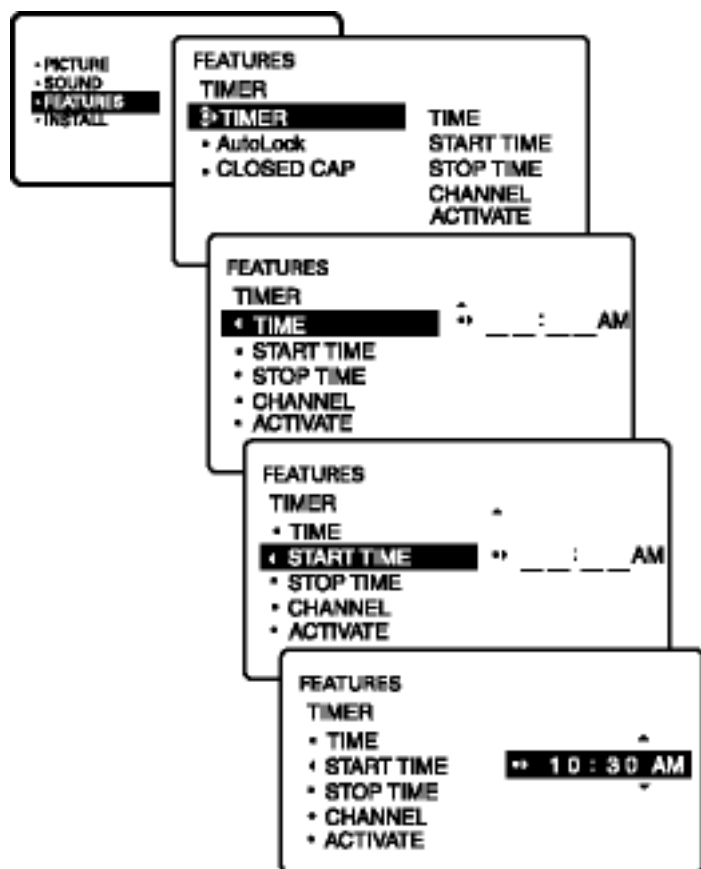

1. Press the MENU button on the remote control to show the on-screen menu.
2. Press twice to highlight FEATURES.
3. Press and the menu will shift to the left. TIMER will be highlighted.
4. Press again to shift the display left. Then press once to highlight the START TIME control.
5. Press again to highlight the time indicator area.
6. Press or to move among the positions where the time is entered.
7. Press or to select the digits for the time or press the NUMBERED buttons to enter the correct time.
8. Press to move to the AM or PM position.
9. Press or to set AM or PM.
10. Press the MENU button repeatedly to clear the menu from the screen.

[RETURN TO TOP OF THE PAGE](#)

Setting the Stop Time

Use the START TIME control to set the TV to turn itself ON once or at the same time every day. The following steps will guide you in setting the TV to turn itself OFF once or at the same time every day.

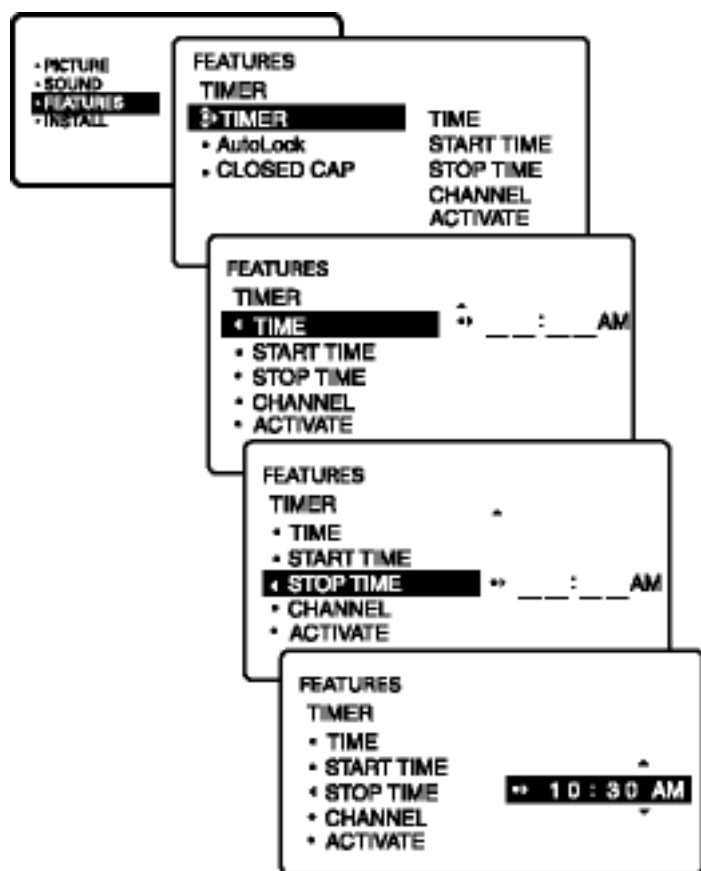

1. Press the MENU button on the remote control to show the on-screen menu.
2. Press twice to highlight FEATURES.
3. Press and the menu will shift to the left. TIMER will be highlighted.
4. Press again to shift the display left. Then press twice to highlight the STOP TIME control.
5. Press again to highlight the time indicator area.
6. Press or to move among the positions where the time is entered.
7. Press or to select the digits for the time or press the NUMBERED buttons to enter the correct time.
8. Press to move to the AM or PM position.
9. Press or to set AM or PM.
10. Press the MENU button repeatedly to clear the menu from the screen.

[RETURN TO TOP OF THE PAGE](#)

Selecting the Channel

You can select a specific channel to appear on the television when the timer turns the set ON. Follow these steps to select the channel.

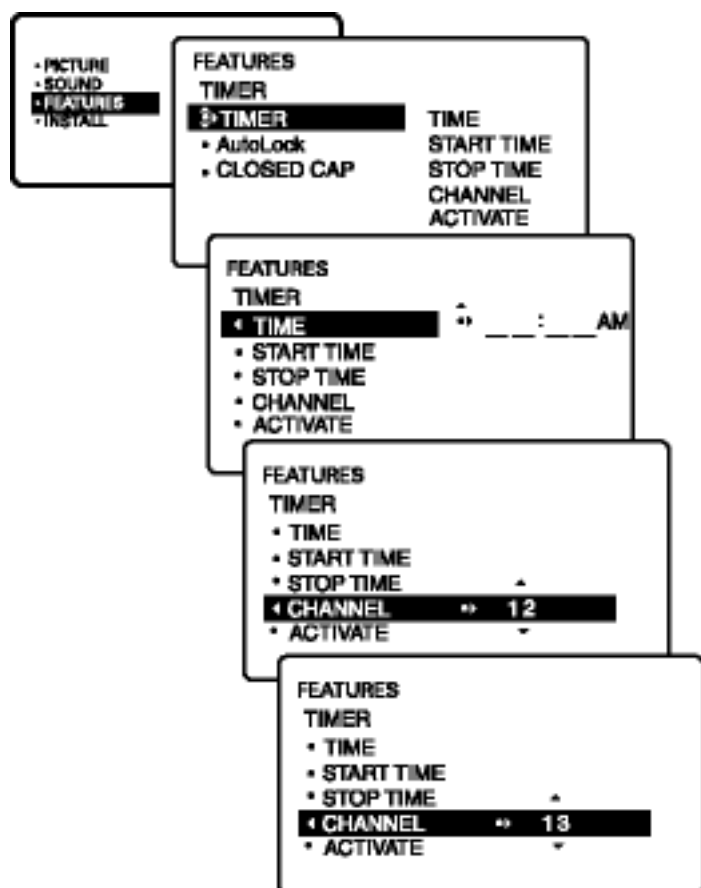

1. Press the MENU button on the remote control to show the on-screen menu.
2. Press twice to highlight FEATURES.
3. Press and the menu will shift to the left. TIMER will be highlighted.
4. Press again to shift the menu to the left. Then press repeatedly until the CHANNEL control is highlighted.
5. Press the NUMBERED buttons to enter the desired start-up channel or press repeatedly to enter the startup channel you want.
6. Press the MENU button repeatedly to clear the menu from the screen.

[RETURN TO TOP OF THE PAGE](#)

Setting Activate to ON or OFF

After you have set the Time, Start Time, Stop Time, and Start Channel, the timer must be set to come on ONCE or DAILY, or turned OFF using the ACTIVATE control.

1. Press the MENU button on the remote control to show the on-screen menu.
2. Press twice to highlight FEATURES.
3. Press and the menu will shift to the left. TIMER will be highlighted.
4. Press again to shift the menu to the

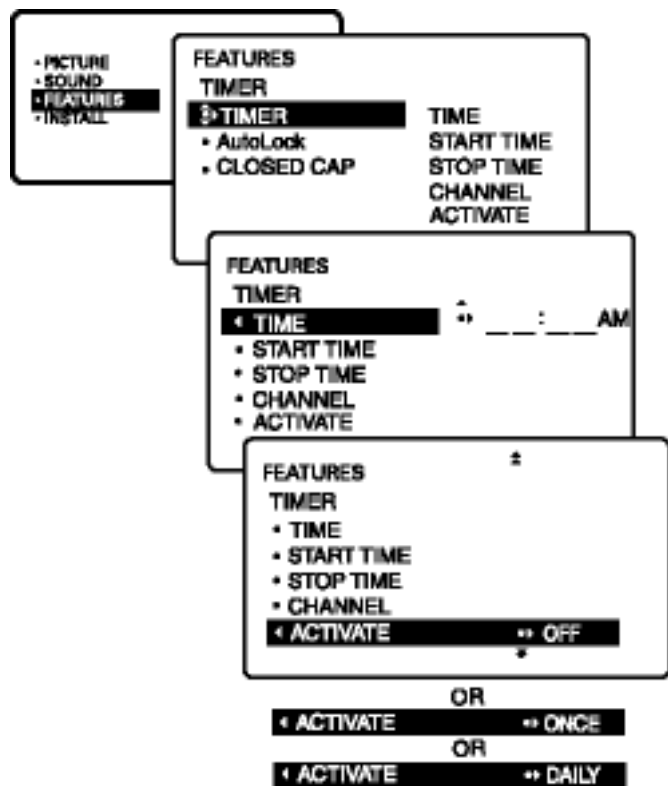

left. Then press repeatedly until the ACTIVATE control is highlighted.

5. Press again to set ACTIVATE to ONCE; press again for DAILY; and press again to toggle ACTIVATE to OFF.
6. Press the MENU button repeatedly to clear the menu from the screen.

[RETURN TO TOP OF THE PAGE](#)

Turning ON the Timer Display

After the TV's clock has been set, you can use your TV as a clock. The TIMER DISPLAY control allows you to permanently display the time in the upper right corner of the screen.

1. Press the MENU button on the remote control to show the on-screen menu.
2. Press twice to highlight FEATURES.
3. Press and the menu will shift to the left. TIMER will be highlighted.
4. Press again to shift the menu to the left. Then press repeatedly until the DISPLAY control is highlighted.
5. Press or to turn the TIMER DISPLAY ON or OFF.
6. Press the MENU button repeatedly to clear the menu from the screen.

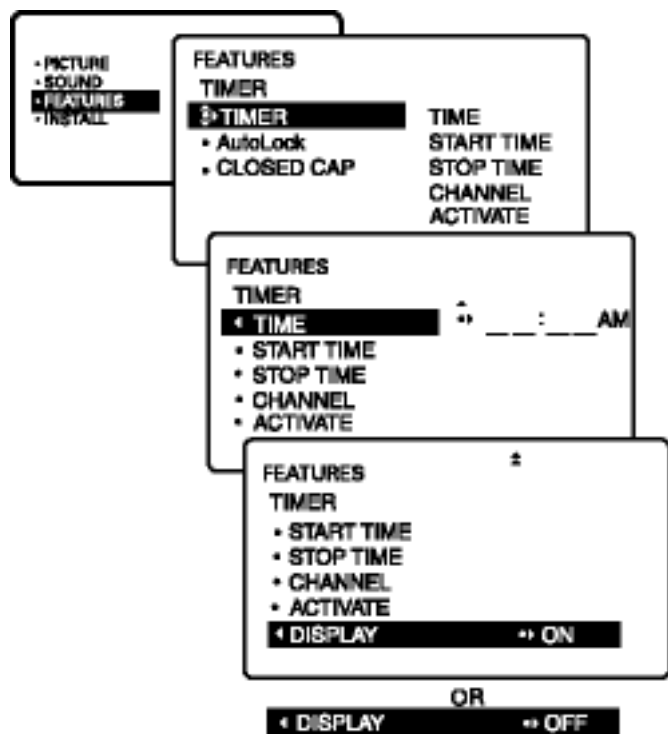

[RETURN TO TOP OF THE PAGE](#)

Understanding AutoLock™

The AutoLock™ feature receives and processes the data that contains programme content advice sent by the broadcasters or other programme providers. When programmed by the viewer, a TV with AutoLock™ can respond to the content advice and block any programme content that may be considered unsuitable (such as offensive language, violence, sexual situations, etc.). This is a great feature for censoring the type of programmes children watch.

In the AutoLock™ section you'll learn how to block channels and programmes that are not rated, are unrated, or have no rating. You will also find out how to turn these blocking features ON or OFF. Below brief explanations are given of some terms and ratings relate to the AutoLock™ feature.

AutoLock™ offers a variety of Blocking Options:

BLOCKING: The BLOCKING control can be thought of as the 'master switch' for AutoLock™. This control implements the settings you have selected in order to block programmes in accordance with movie ratings or TV ratings, or to block programmes

that have no rating or are unrated. When the BLOCKING control is OFF, the blocking or censoring of programmes is disabled. When the BLOCKING control is ON, programmes will be blocked in accordance with the settings you have chosen.

BLOCK UNRATED: All unrated programmes will be blocked if this feature is set to ON.

UNRATED programmes are encoded with information from the MPAA (Motion Picture Association of America) or TV broadcasters, but do not have a specific rating. In other words, the MPAA or the TV broadcasters have chosen not to assign a rating to the programmes.

NO RATING: All programmes with no content advisory data can be blocked if NO RATING is set to ON.

Programmes that have No Rating are not encoded with any rating information from the MPAA or the Parental Guidelines. Any programme could fall into this category.

You can also block individual channels or block programmes on the basis of the ratings of the MPAA and TV broadcasters.

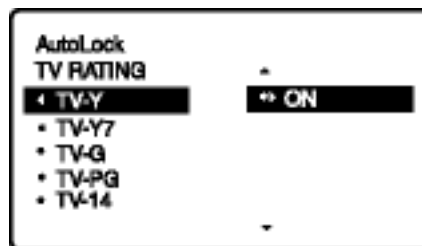
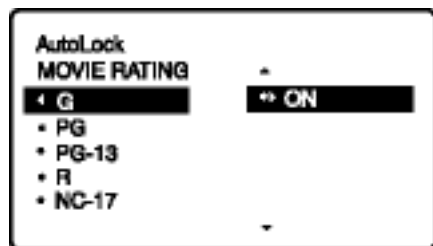

Movie Ratings
(Motion Picture Association of America)

TV Parental Guidelines
(TV Broadcasters)

G: General Audience - All ages admitted. Most parents would find these programmes suitable for all ages. This type of programme contains little or no violence, no strong language and little or no sexual dialogue or sexual situations.

PG: Parental Guidance Suggested - These types of programmes contain material that parents may find unsuitable for children under the age of 13. They will contain one or more of the following violence, sexual situations, coarse language, suggestive dialogue.

R: Restricted - This type of programme has been designed specifically for adults. Anyone under the age of consent should view these programmes only with an accompanying parent or adult guardian. They will contain one or more of the following: intense violence, explicit sexual situations, strong or coarse language, or intensely suggestive dialogue.

NC-17: No one under the age 17 will be admitted. These types of programmes should be viewed by adults only. They will contain graphic violence, explicit sex, or crude, indecent language.

X: Adults Only - These types of programmes contain one or more of the following: very graphic violence, very graphic and explicit or indecent sexual activity, very coarse and intensely suggestive language.

TV-Y: (All children -- These programmes have been designed to be appropriate for all children.) They are intended for a very young audience, including children aged 2-6. This type of programme is not expected to frighten younger children.

TV-Y7: (Directed at Older Children -- These types of programmes are designed for children aged 7 and above.) They may be more appropriate for children who have acquired the development skills needed to distinguish between make-believe and reality. These programmes may include mild fantasy and comic violence (FV).

TV-G: (General Audience -- Most parents would find these programmes suitable for all ages.) These types of programmes contain little or no violence, no strong language, and little or no sexual dialogue or sexual situations.

TV-PG: (Parental Guidance Suggested -- These types of programmes contain material that parents may find unsuitable for younger children.) They will contain one or more of the following: moderate violence (V), some sexual situations (S), infrequent coarse language (L), or some suggestive dialogue (D).

TV-14: (Parents Strongly Cautioned -- These programmes contain some material that many parents would find unsuitable for children under 14 years of age.) These types of programmes contain one or more of the following: intense violence (V), intense sexual situations (S), strong, coarse language (L), or intensely suggestive dialogue (D).





TV-MA: (Mature Audience Only -- These programmes are intended specifically to be viewed by adults and therefore may be unsuitable for children under 17.) They contain one or more of the following:

graphic violence (V), explicit sexual situations (S), or crude, indecent language (L).

[RETURN TO TOP OF THE PAGE](#)

Setting up the Access Code

AutoLock™ allows parents to block out or 'censor' any channels they think children should not watch. A channel blocked by the AutoLock™ control cannot be viewed until a correct access code is used to unlock the channel for viewing. First, let's set your AutoLock access code.

1. Press the MENU button on the remote control to show the on-screen menu.
2. Press  twice to highlight FEATURES.
3. Press  and the menu will shift to the left. Then press  once to highlight the AutoLock control.
4. Use  to highlight ACCESS CODE.
5. Press 0, 7, 1, 1 on the remote control. INCORRECT will appear on the screen.
6. Press 0, 7, 1, 1 on the remote control again. ENTER NEW CODE will appear on the screen.
7. Enter a new four-digit code using the number buttons. CONFIRM CODE will appear on the screen.
8. Enter your new four-digit code again. CORRECT will flash on the screen briefly and the highlight bar goes back to AutoLock.
9. Press the MENU button repeatedly to clear the menu from the screen.

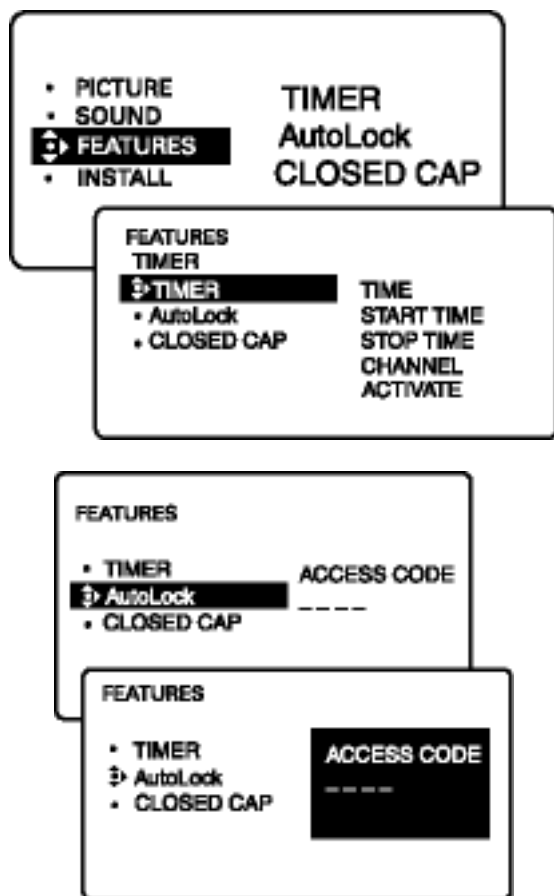







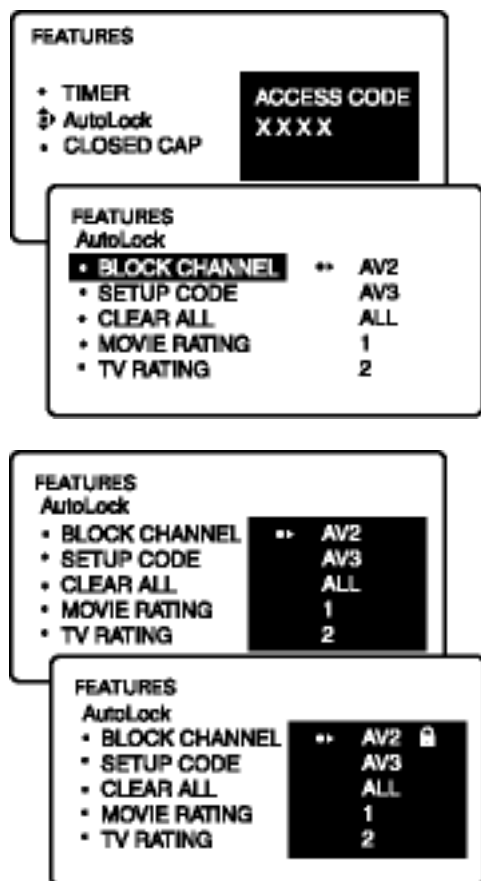

[RETURN TO TOP OF THE PAGE](#)

Blocking Channels

After your personal access code has been set you are ready to select the channels or inputs you want to block out or censor.



1. Press the MENU button on the remote control to show the on-screen menu.
2. Press  twice to highlight FEATURES.
3. Press  and the menu will shift to the left. Then press  once to highlight the AutoLock control.
4. Use  again to highlight ACCESS CODE.
5. Enter your four-digit ACCESS CODE. CORRECT will flash very briefly and the menu will move to the left with BLOCK CHANNEL highlighted.
6. Press  to highlight the TV's available channels.
7. Press  or  to highlight the channel you want to block.
8. Press  to block the channel. A padlock image appears to the right of the channel number. Repeat steps 7 and 8 for any channels you want to block so they cannot be viewed.
9. Press the MENU button repeatedly to clear the menu from the screen.

[RETURN TO TOP OF THE PAGE](#)

Blocking by Movie Rating

After your personal access code has been set you can select specific movie ratings that you want to censor.

1. Press the MENU button on the remote control to show the on-screen menu.
2. Press  twice to highlight FEATURES.

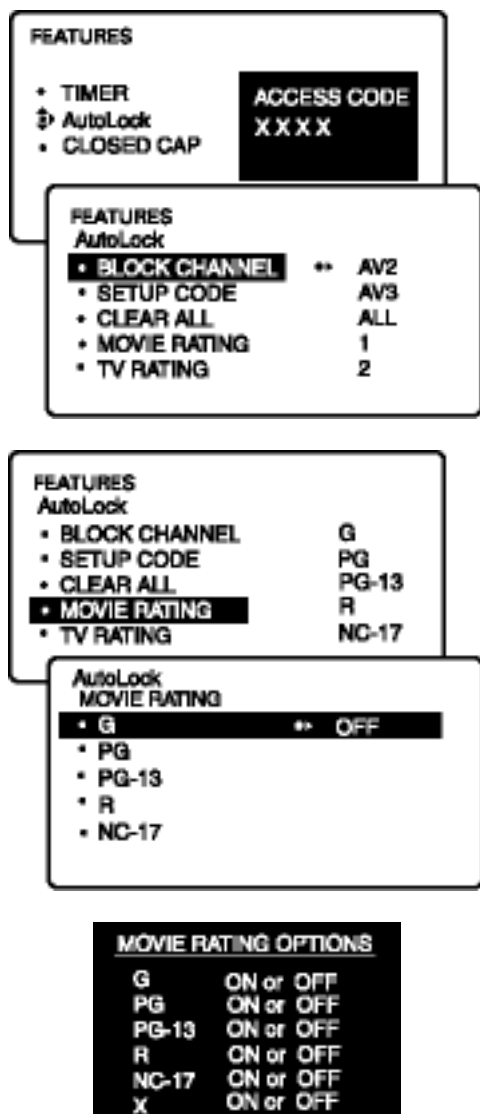

3. Press and the menu will shift to the left. Then press once to highlight the AutoLock control.
4. Use again to highlight ACCESS CODE.
5. Enter your four-digit ACCESS CODE. CORRECT will flash very briefly in red and the menu will move to the left with BLOCK CHANNEL highlighted.
6. Press repeatedly until MOVIE RATING is highlighted.
7. Press and the Rating menu shifts to the left with G highlighted.
8. Press or to highlight each rating you want. (See [Movie Ratings](#)) Then press to turn the rating ON or OFF. Turning the rating ON will block programmes with that rating so they cannot be viewed.
9. Press the MENU button repeatedly to clear the menu from the screen.

[RETURN TO TOP OF THE PAGE](#)

Blocking by TV Rating

You can also select specific TV ratings that you want to censor as follows:

1. Press the MENU button on the remote control to show the on-screen menu.
2. Press twice to highlight FEATURES.

3. Press and the menu will shift to the left. Then press once to highlight the AutoLock control.
4. Use again to highlight ACCESS CODE.
5. Enter your four-digit ACCESS CODE and the menu will move to the left with BLOCK CHANNEL highlighted.
6. Press repeatedly until TV RATING is highlighted.
7. Press and the menu will shift to highlight the TV RATING options.

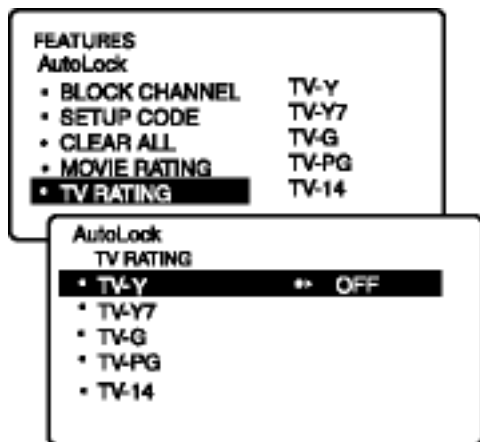

8. Press or to select a rating.
9. Press or to turn the block on the rating ON or OFF.
NOTE: More specific sub ratings (for violence, sexual content, dialogue, or fantasy violence) are available for TV-Y7, TV-PC, TV-14 and TV-MA.
10. To access these sub ratings, press . Press or to select the sub rating that you want to block or unblock. Then press or to turn the block on the sub rating ON or OFF.
11. Press the MENU button repeatedly to clear the menu from the screen.

[RETURN TO TOP OF THE PAGE](#)

Turning Block ON or OFF

The BLOCKING control can be thought of as the 'master switch' for AutoLock™. This control affects the settings you have chosen to block programmes in accordance with movie ratings or TV ratings, or to block programmes that have no rating or are unrated. When the BLOCKING control is OFF, the blocking or censoring of programmes is disabled. When the BLOCKING control is ON, programmes will be blocked in accordance with the settings you have chosen. Follow these steps to toggle BLOCKING OFF or ON.

1. Press the MENU button on the remote control to show the on-screen menu.
2. Press twice to highlight FEATURES.
3. Press and the menu will shift to the left. Then press once to highlight the AutoLock control.
4. Use again to highlight ACCESS CODE.
5. Enter your four-digit ACCESS CODE and the menu will move to the left with BLOCK CHANNEL highlighted.
6. Press repeatedly until BLOCK

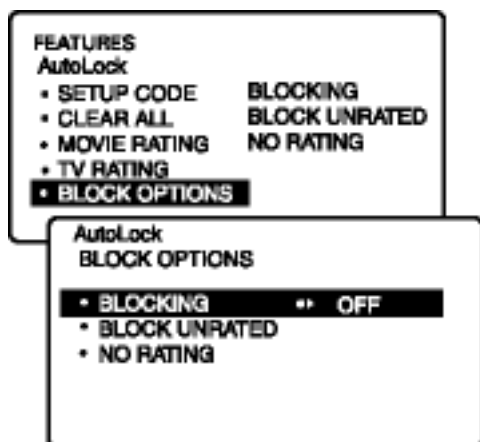

7. Press to enter the BLOCK OPTIONS menu. BLOCKING will be highlighted.
8. Press or to toggle BLOCKING ON or OFF.
9. Press the MENU button repeatedly to clear the menu from the screen.

[RETURN TO TOP OF THE PAGE](#)

Blocking Unrated Broadcasts

In addition to blocking specific ratings or channels, you may choose to block all programmes that are unrated.

1. Press the MENU button on the remote control to show the on-screen menu.
2. Press twice to highlight FEATURES.

3. Press and the menu will shift to the left. Then press once to highlight the AutoLock control.
4. Use again to highlight ACCESS CODE.
5. Enter your four-digit ACCESS CODE and the menu will move to the left with BLOCK CHANNEL highlighted.
6. Press repeatedly until BLOCK OPTIONS is highlighted.
7. Press to enter the BLOCK OPTIONS menu. BLOCKING will be highlighted.
8. Press once to select BLOCK UNRATED.
9. Press or to toggle BLOCK UNRATED ON or OFF.

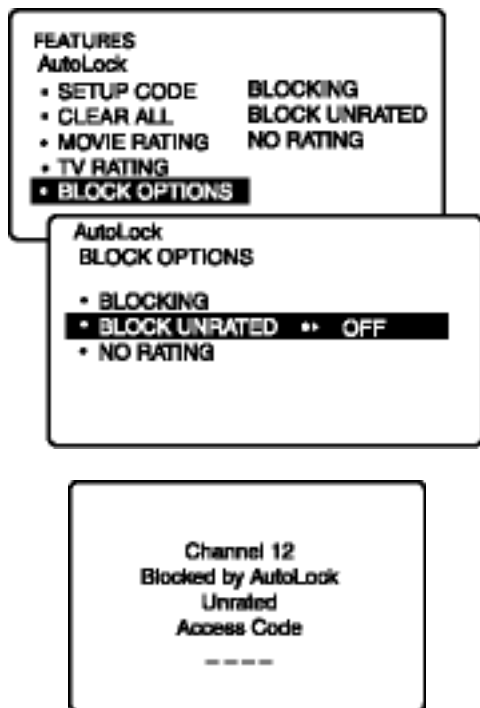

10. Press the MENU button repeatedly to clear the menu from the screen.









NOTE: If the BLOCK OPTIONS, BLOCK UNRATED control is turned ON, all unrated programmes will display the screen shown to the left. To watch the channel, enter your access code or change the BLOCK UNRATED option back to OFF.

[RETURN TO TOP OF THE PAGE](#)

Blocking Broadcasts That Have No Rating

Some programmes are not encoded with content advisory data by the MPAA (Motion Picture Association of America) or the television broadcasters. To block such programmes, follow these steps:

1. Press the MENU button on the remote control to show the on-screen menu.
2. Press  twice to highlight FEATURES.

3. Press  and the menu will shift to the left. Then press  once to highlight the AutoLock control.
4. Use  again to highlight ACCESS CODE.
5. Enter your four-digit ACCESS CODE and the menu will move to the left with BLOCK CHANNEL highlighted.
6. Press  repeatedly until BLOCK OPTIONS is highlighted.
7. Press  to enter the BLOCK OPTIONS menu. BLOCKING will be highlighted.
8. Press  twice to highlight NO RATING.
9. Press  or  to toggle NO RATING ON or OFF.

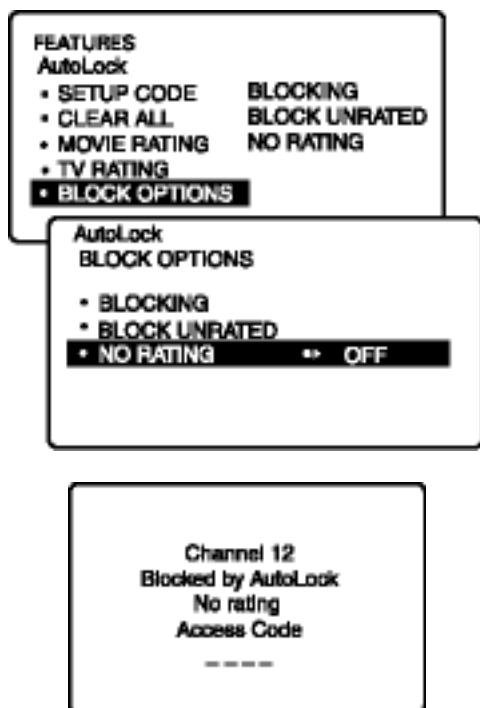

10. Press the MENU button repeatedly to clear the menu from the screen.

NOTE: If the BLOCK OPTIONS, BLOCK UNRATED control is turned ON, all programmes containing NO content advisory data will display the screen shown to the left. To watch the channel, enter your access code or change the NO RATING option back to OFF.

[RETURN TO TOP OF THE PAGE](#)

Viewing Blocked Programming

Various on-screen messages will appear when someone tries to programmes that have been blocked. The message depends on how the current programme has been blocked. You may view the blocked programme and turn OFF the AutoLock™ feature by clearing all blocking options or by entering your access code.

1. Press the MENU button on the remote control to show the on-screen menu.
2. Press twice to highlight FEATURES.
3. Press and the menu will shift to the left. Then press once to highlight the AutoLock control.
4. Use again to highlight ACCESS CODE.
5. Enter your four-digit ACCESS CODE and the menu will move to the left with BLOCK CHANNEL highlighted.
6. Press twice to highlight CLEAR ALL.
7. Press twice. The CLEAR ALL option will display the word CLEARED. All blocked channels and programmes can now be viewed.
8. Press the MENU button repeatedly to clear the menu from the screen.

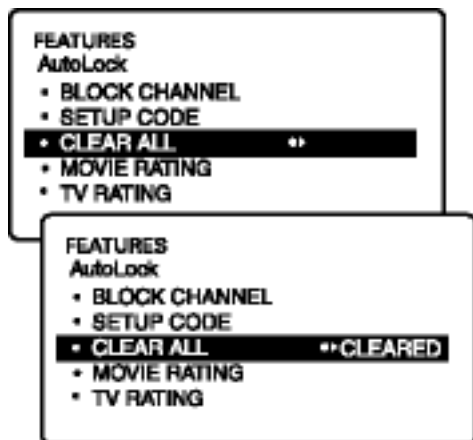







If you tune to a specific channel that has been blocked by BLOCK CHANNEL or any of the AutoLock™ RATING options, simply enter your four-digit access code to view the channel. NOTE: this will unblock ALL channels until the TV is switched OFF. When the power to the TV is switched back ON, all previously blocked channels will be blocked again.

[RETURN TO TOP OF THE PAGE](#)



Using the Closed Captioning Control

Closed Captioning (CD) allows you to read the voice content of television programmes on the TV screen.

Designed to help the hearing impaired, this feature uses on-screen 'text boxes' to show dialogue and conversations while the TV programme is in progress.

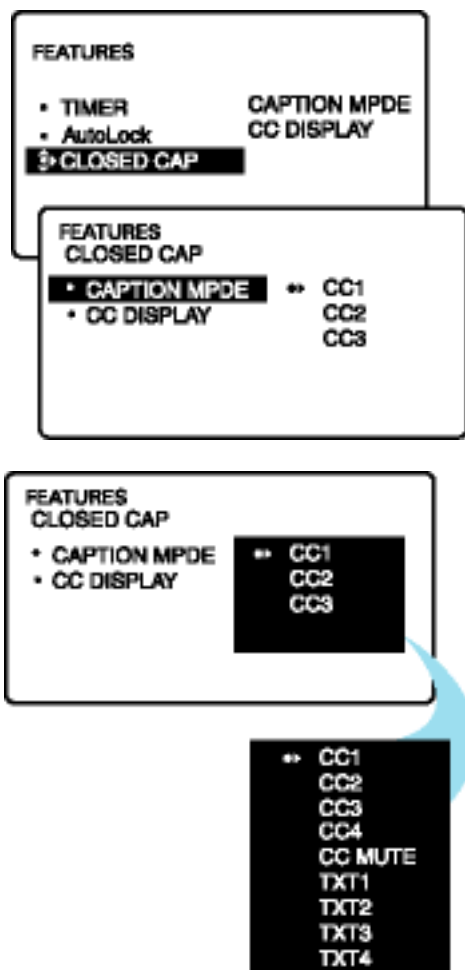
1. Press the MENU button on the remote control to show the on-screen menu.
2. Press  twice to highlight FEATURES.
3. Press  and the menu will shift to the left.
4. Press  repeatedly until the CLOSED CAP control is highlighted.
5. Press  again. The menu will shift to the left and CAPTION MODE will be highlighted. Then press  to highlight CAPTION Modes
6. Press  or  to select a CAPTION MODE: CC1, CC2, CC3, CC4, CC



MUTE, TXT1, TXT2, TXT3 or TXT4. CC DISPLAY turns text OFF or ON if the TV station broadcasting on the channel is making CLOSED CAPTIONING available. With CC DISPLAY highlighted, press  or  to toggle Closed Captioning ON or OFF.

NOTE: You also can press the CC button on the remote control to turn the CC TEXT option ON or OFF.

7. Press the MENU button repeatedly to clear the menu from the screen.

NOTE: Not all TV programmes and product commercials are broadcast with Closed Captioning (CC), nor are all Closed Captioning MODES (CAPTION 1-4 or TEXT 1-4) necessarily used by broadcast stations during the transmission of a programme offering Closed Captioning. Refer to your area's TV programme listings for the stations and times of programmes to be broadcast with Closed Captioning.

NOTE: The CC MUTE option can be used to set the TV to turn the CLOSED CAPTIONING mode ON whenever the MUTE button is pressed.

[RETURN TO TOP OF THE PAGE](#)

Your International Philips F1rst Choice Warranty

Thank you for purchasing this Philips monitor.



All Philips monitors are designed and manufactured to high standards and deliver high-quality performance, ease of use and ease of installation. Should you encounter any difficulties while installing or using this product, please contact Philips directly to benefit from your Philips F1rst Choice Warranty. This three-year service warranty entitles you to a swap model on-site within 48 hours of your call being received.

An extended warranty called Philips F1rst Choice Premium is available in addition to your Philips F1rst Choice warranty. For more details contact your Philips dealer.

Before contacting Philips, please prepare the following details so we can solve your problem quickly.

- Philips type number
- Philips serial number
- Purchase date (copy of purchase may be required)
- PC environment Processor:
 - 286/386/486/Pentium Pro/Internal memory
 - Operating system (Windows, DOS, OS/2, MAC)
 - Fax/Modem/Internet program?
- Other cards installed

Having the following information available will also help speed up the process:

- Your proof of purchase indicating: date of purchase, dealer name, model and product serial number.
- The full address to which the swap model should be delivered.

Just a phone call away

Philips' customer help desks are located worldwide. You can contact Philips Monday - Friday from 08.00 - 20.00 hrs Central European Time (CET) and on Saturdays and Sundays from 10.00 to 18.00 hrs CET by using one of the toll-free numbers. Click here to access the [F1rst Choice Contact Information](#). Or you can reach us via:

Website: <http://www.philips.com>

Your International Guarantee

Dear Customer,

Thank you for purchasing this Philips product which has been designed and manufactured to the highest quality standards.

If, unfortunately, something should go wrong with this product Philips guarantees free of charge labor and replacement parts irrespective of the country where it is repaired during a period of 12 months from date of purchase. This international Philips guarantee complements the existing national guarantee obligations to you of dealers and Philips in the country of purchase and does not affect your statutory rights as a customer.

The Philips guarantee applies provided the product is handled properly for its intended use, in accordance with its operating instructions and upon presentation of the original invoice or cash receipt, indicating the date of purchase, dealer's name and model and production number of the product.

The Philips guarantee may not apply if:

- the documents have been altered in any way or made illegible;
- the model or production number on the product has been altered, deleted, removed or made illegible;
- repairs or product modifications and alterations have been executed by unauthorized service organizations or persons;
- damage is caused by accidents including but not limited to lightning, water or fire, misuse or neglect.

Please note that the product is not defective under this guarantee in the case where modifications become necessary in order for the product to comply with local or national technical standards which apply in countries for which the product was not originally designed and/or manufactured. Therefore always check whether a product can be used in a specific country.

In case your Philips product is not working correctly or is defective, please contact your Philips dealer. In the event you require service whilst in another country a dealer address can be given to you by the Philips Consumer Help Desk in that country, the telephone and fax number of which can be found in the relevant part of this booklet.

In order to avoid unnecessary inconvenience, we advise you to read the operating instructions carefully before contacting your dealer. If you have questions which your dealer cannot answer or any related question please contact the [Philips Consumer Information Centers](#) or via:

Website: <http://www.philips.com>

LIMITED WARRANTY (Computer Monitor)

Click here to access the [Warranty Registration Card](#).

Three Years Free Labor / Three Years Free Service on Parts / One Year Exchange*

**Product will be exchanged with a new or renewed to original specifications unit within two business days for the first year. This product must be shipped in at your expense for service during years two and three.*

WHO IS COVERED?

You must have proof of purchase to receive warranty service. A sales receipt or other document showing that you purchased the product is considered proof of purchase. Attach it to this owner's manual and keep both nearby.

WHAT IS COVERED?

Warranty coverage begins the day you buy your product. *For three years thereafter*, all parts will be repaired or replaced, and labor is free. *After three years from the day of purchase*, you pay for the replacement or repair of all parts, and for all labor charges.

All parts, including repaired and replaced parts, are covered only for the original warranty period. When the warranty on the original product expires, the warranty on all replaced and repaired products and parts also expires.

WHAT IS EXCLUDED?

Your warranty does not cover:

- labor charges for installation or setup of the product, adjustment of customer controls on the product, and installation or repair of antenna systems outside of the product.
- product repair and/or part replacement because of misuse, accident, unauthorized repair or other cause not within the control of Philips Consumer Electronics.
- reception problems caused by signal conditions or cable or antenna systems outside the unit.
- a product that requires modification or adaptation to enable it to operate in any country other than the country for which it was designed, manufactured, approved and/or authorized, or repair of products damaged by these modifications.
- incidental or consequential damages resulting from the product. (Some states do not allow the exclusion of incidental or consequential damages, so the above exclusion may not apply to you. This includes, but is not limited to, prerecorded material, whether copyrighted or not copyrighted.)
- a product used for commercial or institutional purposes.

Where IS SERVICE AVAILABLE?

Warranty service is available in all countries where the product is officially distributed by Philips Consumer Electronics. In countries where Philips Consumer Electronics does not distribute the product, the local

Philips service organization will attempt to provide service (although there may be a delay if the appropriate spare parts and technical manual(s) are not readily available).

Where CAN I GET MORE INFORMATION?

For more information, contact the Philips Customer Care Center by calling [\(877\) 835-1838 \(U.S.A. customers only\)](tel:877-835-1838) or [\(423\) 475-0280](tel:423-475-0280).

Before Requesting Service...

Please check your owner's manual before requesting service. Adjustments of the controls discussed there may save you a service call.

TO GET WARRANTY SERVICE IN U.S.A., PUERTO RICO OR U.S. VIRGIN ISLANDS...

Contact the Philips Customer Care Center phone number listed below for product assistance and procedures for servicing:

Philips Customer Care Center

(877) 835-1838 or (423) 475-0280

(In U.S.A., Puerto Rico and U.S. Virgin Islands, all implied warranties, including implied warranties of merchantability and fitness for a particular purpose, are limited in duration to the duration of this express warranty. But, because some states do not allow limitations on how long an implied warranty may last, this limitation may not apply to you.)

TO GET WARRANTY SERVICE IN CANADA...

Please contact Philips at:

(800) 479-6696

Three years free parts and three years free labor will be provided at Philips Canada depot or any one of its authorized service centers.

(In Canada, this warranty is given in lieu of all other warranties. No other warranties are expressed or implied, including any implied warranties of merchantability or fitness for a particular purpose. Philips is not liable under any circumstances for any direct, indirect, special, incidental or consequential damages, howsoever incurred, even if notified of the possibility of such damages.)

REMEMBER... Please record the model and serial numbers found on the product below.

MODEL # _____

SERIAL # _____

This warranty gives you specific legal rights. You may have other rights which vary from state/province to state/province.

Philips Customer Care Center, P. O. Box 2976, Longview, TX 75601

Your International Philips F1rst Choice Warranty

Thank you for purchasing this Philips monitor.



All Philips monitors are designed and manufactured to high standards and deliver high-quality performance, ease of use and ease of installation. Should you encounter any difficulties while installing or using this product, please contact Philips directly to benefit from your Philips F1rst Choice Warranty. This three-year service warranty entitles you to a swap model on-site within 48 hours of your call being received within the first year of purchase. If you have any problems with your monitor within the second or third year of purchase, we will repair it after it has been sent to the service provider at your expense and returned to you within five working days, free of charge.

An extended warranty called Philips F1rst Choice Premium is available in addition to your Philips F1rst Choice warranty. For more details contact your Philips dealer.

Before contacting Philips, please prepare the following details so we can solve your problem quickly.

- Philips type number
- Philips serial number
- Purchase date (copy of purchase may be required)
- PC environment Processor:
 - 286/386/486/Pentium Pro/Internal memory
 - Operating system (Windows, DOS, OS/2, MAC)
 - Fax/Modem/Internet program?
- Other cards installed

Having the following information available will also help speed up the process:

- Your proof of purchase indicating: date of purchase, dealer name, model and product serial number.
- The full address to which the swap model should be delivered.

Just a phone call away

Philips' customer help desks are located worldwide. You can contact Philips Monday - Friday from 08.00 - 20.00 hrs Central European Time (CET) and on Saturdays and Sundays from 10.00 to 18.00 hrs CET by using one of the toll-free numbers. Click here to access the [F1rst Choice Contact Information](#). Or you can reach us via:

Website: <http://www.philips.com>

F1rst Choice Contact Information

Telephone numbers:

Austria	01 546 575 603	Luxembourg	408 443 5501
Belgium	02 275 0701	Netherlands	053 482 9800
Cyprus (Greek)	800 92256	Norway	22 70 82 50
Denmark	35 25 87 61	Portugal	0800 831 363
France	03 8717 0033	Sweden	08 632 0016
Germany	0696 698 4712	Switzerland	02 23 10 21 16
Greece	00800 3122 1223	Spain	09 17 45 62 46
Finland	09 2290 1908	United Kingdom	0207 949 0069
Ireland	01 601 1161	U.S.A.	877 835 1838
Italy	02 48 27 11 53		

Consumer Information Centers

[Antilles](#) • [Argentina](#) • [Australia](#) • [Bangladesh](#) • [Brasil](#) • [Canada](#) • [Chile](#) • [China](#) • [Colombia](#) • [Czech Republic](#) • [Dubai](#) • [Egypt](#) • [Hong Kong](#) • [Hungary](#) • [India](#) • [Indonesia](#) • [Korea](#) • [Malaysia](#) • [Mexico](#) • [Morocco](#) • [New Zealand](#) • [Pakistan](#) • [Paraguay](#) • [Peru](#) • [Philippines](#) • [Poland](#) • [Russia](#) • [Singapore](#) • [South Africa](#) • [Taiwan](#) • [Thailand](#) • [Turkey](#) • [Uruguay](#) • [Venezuela](#)

Eastern Europe

CZECH REPUBLIC

Philips Service
V Mezihorí 2180 00 Prague
Phone: (02)-6831581
Fax : (02)-66310852

HUNGARY

Philips Markaszerviz.
Kinizsi U 30-36Budapest 1092
Phone: (01)-2164428
Fax : (01)-2187885

POLAND

Philips Polska CE
UL.Marszalkowska 45/49
00-648 Warszawa
Phone: (02)-6286070
Fax : (02)-6288228

RUSSIA

Philips Representation Office
Ul. Usacheva 35a
119048 Moscow
Phone: 095-937 9300
Fax : 095-755 6923

TURKEY

Türk Philips Ticaret A.S.
Talatpasa Caddesi No 5.
80640-Gültepe/Istanbul
Phone: (0800)-211 40 36
Fax : (0212)-281 1809

Latin America

ANTILLES

Philips Antillana N.V.
Kaminda A.J.E. Kusters 4
Zeelandia, P.O. box 3523-3051
Willemstad, Curacao
Phone: (09)-4612799
Fax : (09)-4612772

ARGENTINA

Philips Antillana N.V.
Vedia 3892 Capital Federal
CP: 1430 Buenos Aires
Phone: (011)-4544 2047

BRASIL

Philips da Amazônia Ind. Elet. Ltda.
Av. Luis Carlos Berrini,
1400 - Sao Paulo -SP
Phone: 0800-701-0203

CHILE

Philips Chilena S.A.
Avenida Santa Maria 0760
P.O. box 2687 Santiago de Chile
Phone: (02)-730 2000
Fax : (02)-777 6730

COLOMBIA

Industrias Philips de Colombia
S.A.-Division de Servicio
CARRERA 15 Nr. 104-33
Bogota, Colombia
Phone:(01)-8000 111001 (toll free)
Fax : (01)-619-4300/619-4104

MEXICO

Consumer Information Centre
Norte 45 No.669
Col. Industrial Vallejo
C.P.02300, -Mexico, D.F.
Phone: (05)-3687788 / 9180050462
Fax : (05)-7284272

PARAGUAY

Philips del Paraguay S.A.
Avenida Artigas 1513
Casilla de Correos 605
Asuncion
Phone: (021)-211666
Fax : (021)-213007

PERU

Philips Peruana S.A.
Customer Desk
Comandante Espinar 719
Casilla 1841
Limab18
Phone: (01)-2136200
Fax : (01)-2136276

URUGUAY

Ind.Philips del Uruguay S.A.
Luis Alberto de Herrera 1248
Customer Help Desk
11300 Montevideo
Phone: (02)-6281111
Fax : (02)-6287777

VENEZUELA

Industrias Venezolanas Philips S.A.
Apartado Postal 1167
Caracas 1010-A
Phone: (02) 2377575
Fax : (02) 2376420

Canada

CANADA

Philips Electronics Ltd.
281 Hillmount Road
Markham, Ontario L6C 2S3
Phone: (800) 479-6696

Pacific

AUSTRALIA

Philips Consumer Service.
Customer Information Centre.
3 Figtree Drive
Homebush Bay NSW 2140
Phone: CIC: 1300-363 391 PCE Service: 1300-361 392 (toll free)
Fax : +61 2 9947 0063

NEW ZEALAND

Philips New Zealand Ltd.
Consumer Help Desk
2 Wagener Place, Mt. Albert
P.O. box 1041
Auckland
Phone: 0800 477 999 (toll free)
Fax : 0800 288 588 (toll free)

Asia

BANGLADESH

Philips Service Centre
100 Kazi Nazrul Islam
Avenue Kawran Bazar C/A
Dhaka-1215
Phone: (02)-812909
Fax : (02)-813062

CHINA

BEIJING
Beijing Authorized Service Centre.
Consumer Information Centre
Building 6, West Street
Chong Wen Men, Beijing, Jin Bang Co. Led.
100051 BEIJING

GUANGZHOU
Philips Authorized Service Centre
801 Dong Feng Road East
Guangzhou 510080

SHANGHAI
Philips Service Logistic Centre
Consumer Information Centre
P.O.Box 002-027, Nextage Department Store
Puding New District
200002 SHANGHAI

Philips Authorized Service Centre
Consumer Information Centre
148 Fu Jian Road M
200001 Shanghai

Phone: 800 820 5128 (toll free)
Fax: 21-656 10647

HONG KONG

Philips Hong Kong Limited
Consumer Information Centre
16/F Hopewell Centre
17 Kennedy Road, WANCHAI
Phone: 2619 9663
Fax : 2481 5847

INDIA

Phone: 91-20-712 2048 ext: 2765
Fax: 91-20-712 1558

BOMBAY
Philips India
Customer Relation Centre
Bandbox House
254-D Dr. A Besant Road, Worli
Bombay 400 025

CALCUTTA
Customer Relation Centre
7 justice Chandra Madhab Road
Calcutta 700 020

MADRAS
Customer Relation Centre
3, Haddows Road
Madras 600 006

NEW DELHI
Customer Relation Centre
68, Shivaji Marg
New Dehli 110 015

INDONESIA

Philips Group of Companies in Indonesia
Consumer Information Centre
Jl.Buncit Raya Kav. 99-100
12510 Jakarta
Phone: (021)-794 0040 / 798 4255 ext: 1612
Fax : (021)-794 7511 / 794 7539

KOREA

Philips Korea Ltd.
Philips House
C.P.O. box 3680
260-199, Itaewon-Dong.
Yongsan-Ku, Seoul 140-202
Phone:080-600-6600 (Local toll free)
Fax : (02)-709-1245

MALAYSIA

Philips Malaysia Sdn. Berhad
Service Dept.
No.51,sect.13 Jalan University.
46200 Petaling Jaya, Selagor.
P.O.box 12163
50768 Kuala Lumpur.
Phone: (03)-7950 5501/02
Fax : (03)-7954 8504

PAKISTAN

KARACHI
Philips Electrical Ind. of Pakistan
Consumer Information Centre
F-54, S.I.T.E, P.O.Box 7101
75730 KARACHI

Philips Consumer Service Centre
168-F, Adamjee Road
Rawalpindi Cantt

Phone: (021)-7731927
Fax : (021)-7721167

PHILIPPINES

Philips Electronics and Lighting Inc.
106 Valero St., Salcedo Village
Makati, Metro Manilla.
Phone: (02)-888 05 72
Domestic toll free: 1-800-10-PHILIPS or 1-800-10-744 5477
Fax : (02)-888 05 71

SINGAPORE

Philips Singapore Private Ltd.
Consumer Service Dept.
Lorong 1, Toa Payoh., P.O. box 340
Singapore 1231
Phone: 6882 3999
Fax : 6250 8037

TAIWAN

Philips Taiwan Ltd.
Consumer Information Centre
26F, 66, Chung-Hsiao W. Road Sec. 1
TAIPEI
Phone: 0800-231-099 or (02)-2382-4567
Fax : (02)-2382-3027

THAILAND

Philips Electronics (Thailand) Ltd.
Philips Service Centre
209/2 Sanpavut Road,
Bangna, Bangkok 10260
Phone : (02)-652 8652
Fax : (02)-614 3531

Africa

MOROCCO

Philips Electronique Maroc
304, BD Mohamed V
Casablanca
Phone: (02)-302992
Fax : (02)-303446

SOUTH AFRICA

South African Philips.
S.V. Div. 195 Main R.D.
Martindale., Johannesburg
P.O.box 58088
Newville 2114
Phone: +27 11 471 5000
Fax : +27 11 471 5020

Middle East

DUBAI

Philips Middle East B.V.
Consumer Information Centre
P.O.Box 7785
DUBAI
Phone: (04)-335 3666
Fax : (04)-335 3999

EGYPT

Philips Egypt
Consumer Information Centre
10, Abdel Rahman El Rafei
Mohandessin - Cairo, P.O.Box 242
DOKKI
Phone: (02)-3313993
Fax : (02)-3492142

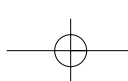

It Takes Only A Moment To PROTECT YOUR INVESTMENT.

Congratulations on investing in a Philips product. It's an important and intelligent decision that's sure to reward you for many years to come. To ensure you'll get all of the privileges and protection that come with your purchase, please complete your Warranty Registration Card within the next ten days.

SIMPLY MAIL THE CARD BELOW TO RECEIVE ALL OF THESE BENEFITS TO WHICH YOU'RE ENTITLED.

WARRANTY VERIFICATION

Your prompt registration verifies your right to protection under the terms and conditions of your warranty.

OWNER CONFIRMATION

Your completed Warranty Registration Card serves as confirmation of ownership in the event of product loss or theft.

MODEL REGISTRATION

Returning the attached card right away guarantees you'll receive all information and special offers for which your purchase makes you eligible. So please act today!

www.philipsusa.com

DETACH AND MAIL PORTION BELOW.

WARRANTY REGISTRATION CARD

MODEL NUMBER	SERIAL NUMBER
--------------	---------------

Registering your product is an essential step to ensure that you receive all of the benefits you are entitled to as a Philips customer. So complete the information below in ink, and drop this card in the nearest mailbox.

IMPORTANT - RETURN WITHIN TEN DAYS

Date of Purchase: / /
Month Day Year

Your Name:
First Initial Last

Address:
Street

City State ZIP Code Apt. #

Retail Price Paid \$.00
(Excluding sales tax, maintenance agreement, delivery, installation, and trade-in allowance.)

Your Phone Number (optional):
Area Code Phone Number

E-mail Address (optional):



Mail This Card Today To Get The Most From Your Purchase!

No, I do not want to receive personalized offers about Philips products or other information from Philips in the future.

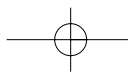

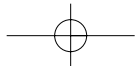

PO BOX 1533
DEPOSIT NY 13754-1533

PHILIPS

**TIME-DATED
MATERIAL
Please Open
Promptly!**

PLEASE
APPLY FIRST
CLASS
STAMP



IMPORTANT

PHILIPS
Warranty
Registration Card

**RETURN THE ATTACHED CARD WITHIN
TEN DAYS TO ENSURE YOUR:**

- ✓ Warranty Verification
- ✓ Owner Confirmation
- ✓ Model Registration

*See Inside For
Valuable
Benefits!*

