



INSTRUCTION MANUAL

COOL/DRY Model

Split System Air Conditioner

KS0951
KS1251
KS1852



Save These Instructions!

VERIFIED



Energy
Performance
Rendement
Énergétique

VÉRIFIÉ

Features

This air conditioner is equipped with cooling and drying functions. Details on these functions are provided below; refer to these descriptions when using the air conditioner.

- **Microprocessor Controlled Operation**
The interior compartment of the remote control unit contains several features to facilitate automatic operation, each logically displayed for easy use.
- **Air Sweep Control**
This function moves a flap up and down in the air outlet, directing air in a sweeping motion around the room and providing comfort in every corner.
- **Simple One-touch Wireless Remote Control**
The remote control unit has several features to facilitate automatic operation.
- **Automatic Restart Function for Power Failure**
Even when power failure occurs, preset programmed operation can be reactivated once power resumes.
- **24-Hour ON or OFF Timer**
This timer can be set to automatically turn the unit on or off at any time within a 24 hour period.
- **Anti-Mold Filter**
This unit is equipped with an anti-mold filter that inhibits the growth of mold and bacteria.
- **1-Hour OFF Timer**
This timer can be set to automatically turn off the unit at any time after one hour.
- **Optional Air Clean Filter**
An air filter that uses activated charcoal to eliminate unpleasant odors and clean the air is available (sold separately).
- **Night Setback**
Pressing this button changes the setting of the room temperature thermostat, allowing you to set the temperature at whatever level that you find comfortable.
- **Automatic and 3-step Fan Speed**
Auto/High/Medium/Low

Contents

	Page
Features.....	2
Product Information.....	3
Alert Symbols.....	3
Installation Location.....	4
Electrical Requirements.....	4
Safety Instructions.....	4
Names of Parts.....	5
Using the Remote Control Unit.....	10
Operation with the Remote Control Unit.....	12
1. Manual Operation.....	12
2. Adjusting the Fan Speed.....	13
3. Night Setback Mode.....	14
Special Remarks.....	15
Setting the Timer.....	16
Setting the 1-Hour OFF Timer.....	18
Adjusting the Airflow Direction.....	19
Operation without the Remote Control Unit.....	20
Care and Cleaning.....	20
Tips for Energy Saving.....	23
Troubleshooting.....	24
Operating Range.....	24

Product Information

If you have problems or questions concerning your Air Conditioner, you will need the following information. Model and serial numbers are on the nameplate on the bottom of the cabinet.

Model No. _____ Serial No. _____

Date of purchase _____

Dealer's address _____

Phone number _____

Alert Symbols

The following symbols used in this manual, alert you to potentially dangerous conditions to users, service personnel or the appliance:



WARNING

This symbol refers to a hazard or unsafe practice which can result in severe personal injury or death.



CAUTION

This symbol refers to a hazard or unsafe practice which can result in personal injury or product or property damage.

Installation Location

- **We recommend that this air conditioner be installed properly by qualified installation technicians in accordance with the Installation Instructions provided with the unit.**
- Before installation, check that the voltage of the electric supply in your home or office is the same as the voltage shown on the nameplate.



WARNING

- **Do not install this air conditioner where there are fumes or flammable gases, or in an extremely humid space such as a greenhouse.**
- **Do not install the air conditioner where excessively high heat-generating objects are placed.**

Avoid: To protect the air conditioner from heavy corrosion, avoid installing the outdoor unit where salty sea water can splash directly onto it or in sulphurous air near a spa.

Electrical Requirements

1. All wiring must conform to the local electrical codes. Consult your dealer or a qualified electrician for details.
2. Each unit must be properly grounded with a ground (or earth) wire or through the supply wiring.
3. Wiring must be done by a qualified electrician.

Safety Instructions

- **Read this Instruction Manual carefully before using this air conditioner. If you still have any difficulties or problems, consult your dealer for help.**
- **This air conditioner is designed to give you comfortable room conditions. Use this only for its intended purpose as described in this Instruction Manual.**



WARNING

- **Never use or store gasoline or other flammable vapor or liquid near the air conditioner — it is very dangerous.**
- **This air conditioner has no ventilator for intaking fresh air from outdoors. You must open doors or windows frequently when you use gas or oil heating appliances in the same room, which consume a lot of oxygen from the air. Otherwise there is a risk of suffocation in an extreme case.**



CAUTION

- **Do not turn the air conditioner on and off from the power mains switch. Use the ON/OFF operation button.**
- **Do not stick anything into the air outlet of the outdoor unit. This is dangerous because the fan is rotating at high speed.**
- **Do not let children play with the air conditioner.**
- **Do not cool the room too much if babies or invalids are present.**

Names of Parts

INDOOR UNIT

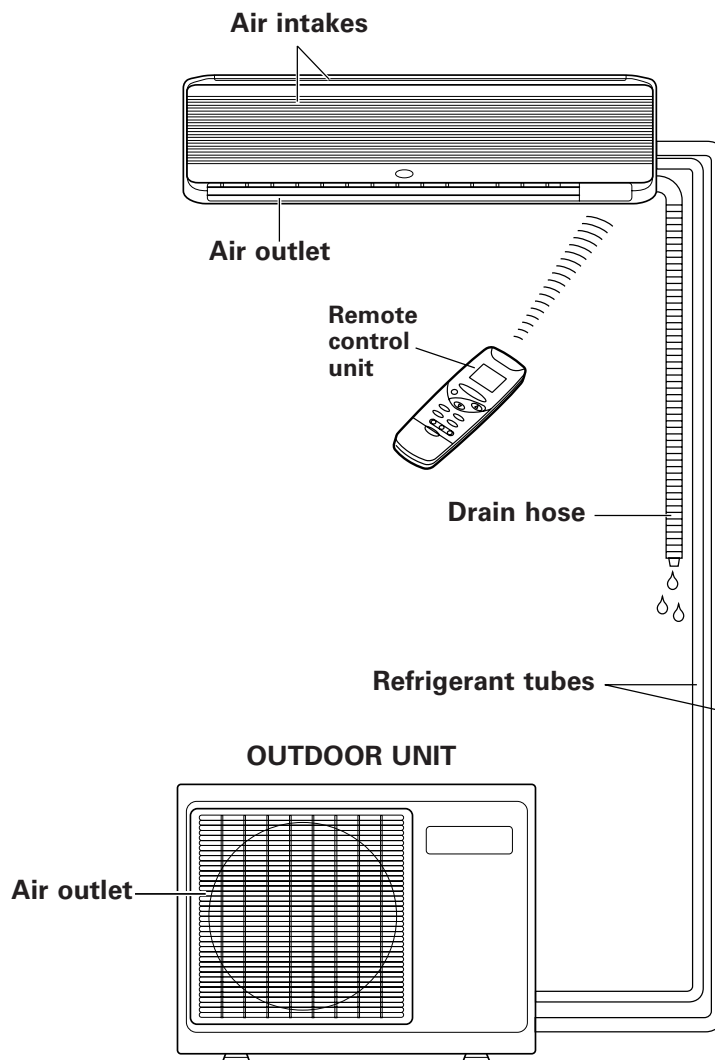

NOTE

This illustration is based on the external appearance of a standard model. Consequently, the shape may differ from that of the air conditioner which you have selected.

This air conditioner consists of an indoor unit and an outdoor unit. You can control the air conditioner with the remote control unit.

Air Intakes	Air from the room is drawn into these sections and passes through air filters which remove dust.
Air Outlet	Air is blown out of the air conditioner through the air outlet.
Remote Control Unit	The wireless remote control unit controls power on/off, operation mode selection, temperature, fan speed, timer setting, night setback and air sweeping.
Refrigerant Tubes	The indoor and outdoor units are connected by copper tubes through which refrigerant gas flows.
Drain Hose	Moisture in the room condenses and drains off through this hose.
Outdoor (Condensing) Unit	The outdoor unit contains the compressor, fan motor, heat exchanger coil, and other electrical components.

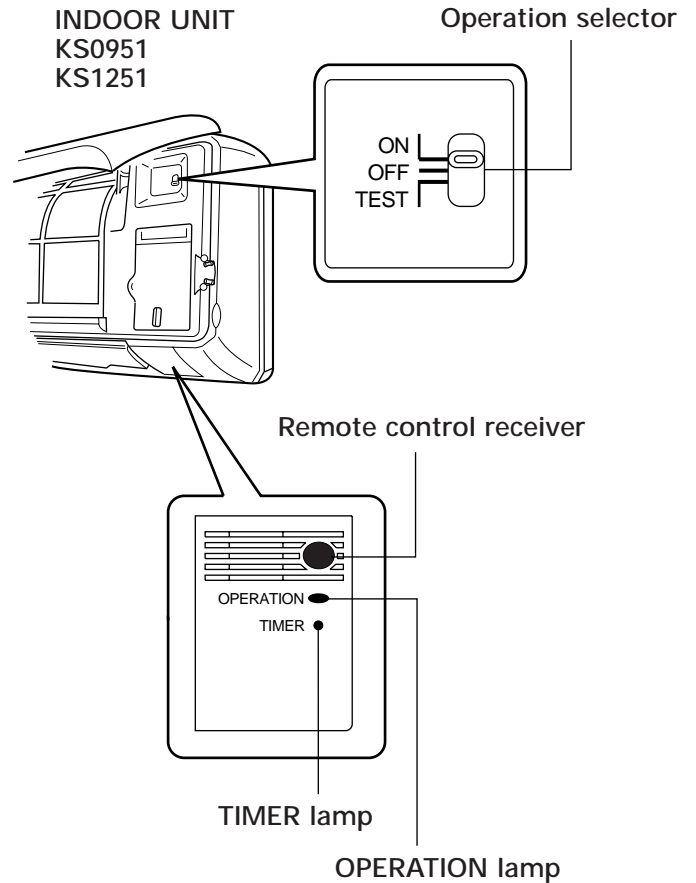
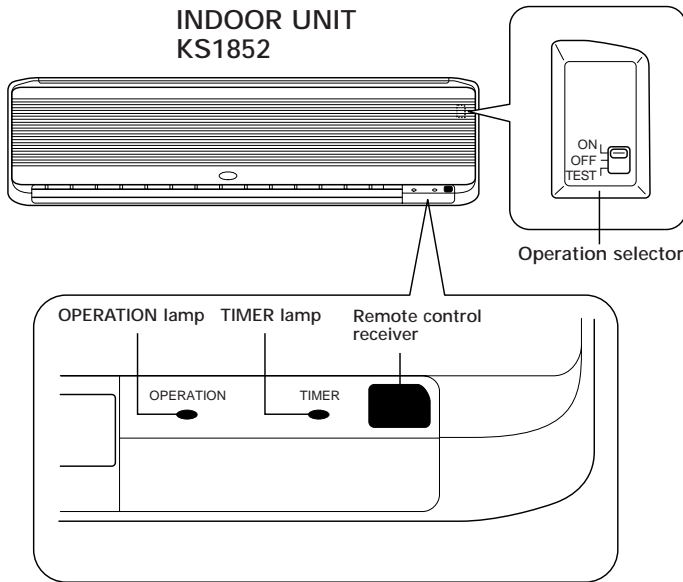

Unit Display and Operation Selector



IMPORTANT

Avoid using radio equipment such as mobile phones near (within 4 ft. of) the indoor unit. Some radio equipment may cause the unit to malfunction.

If the trouble occurs, disconnect power and restart the air conditioner after a few minutes.

Remote control receiver	This section picks up infrared signals from the remote control unit (transmitter).
Operation selector ON position	This position is for operating the air conditioner with the wireless remote control unit. Set the selector normally in this position.
OFF position	Switch the selector to the OFF position if you are not going to use the air conditioner for a few days or longer.
 WARNING	The OFF position does not disconnect the power. Use the main power switch to turn off power completely.
TEST position	This position is used only when servicing the air conditioner.
 CAUTION	Do not set the operation selector at the TEST position for normal operation.
OPERATION lamp	This lamp lights when the system is in the continuous DRY and COOL mode.
TIMER lamp	This lamp lights when the system is being controlled by the timer.

Remote Control Unit (Display)

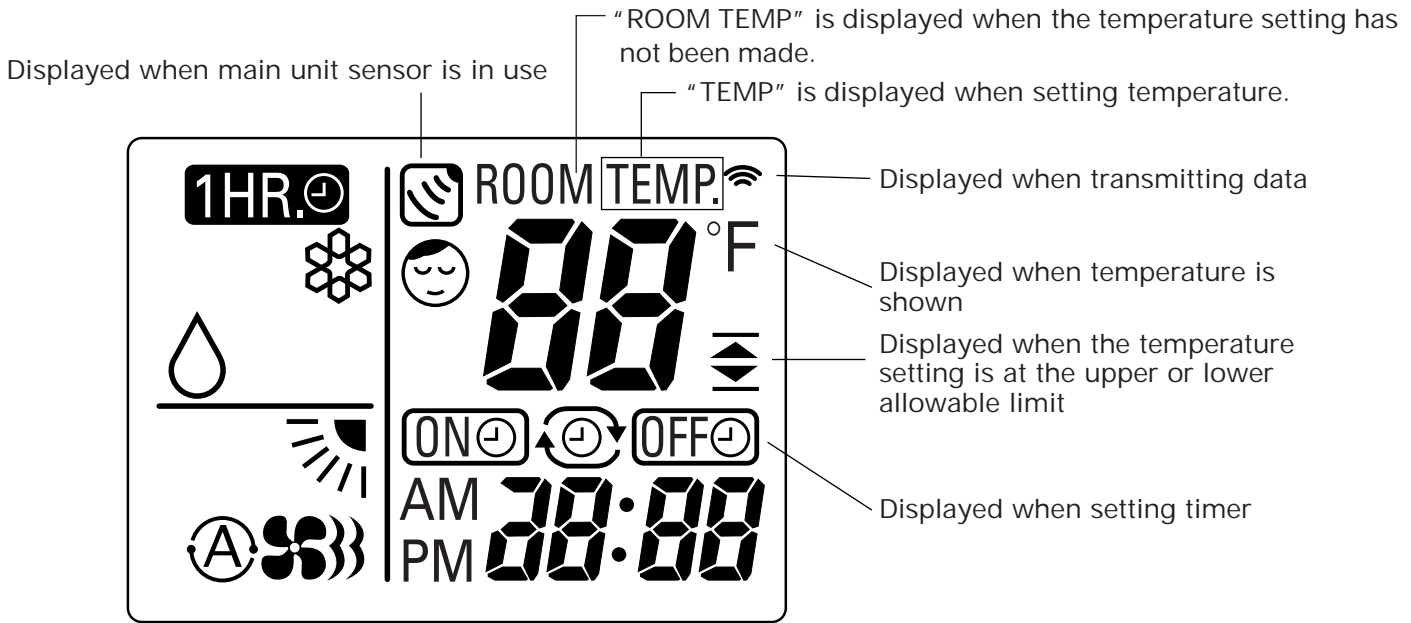

Symbols

(1) Operation mode

MILD DRY..... 

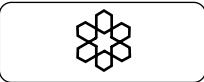
COOL..... 

(2) Fan speed

AUTO..... 

HIGH..... 

MEDIUM..... 

LOW..... 

(3) Temperature setting

60 — 86 °F
When set to 82 °F
temperature indication..... 

(4) Timer

24-hour clock with ON/OFF
program Timer 

24-hour ON Timer..... 

24-hour OFF Timer..... 

1-hour OFF Timer..... 

(5) NIGHT SETBACK..... 

(6) Confirmation of
transmission..... 

(7) Flap



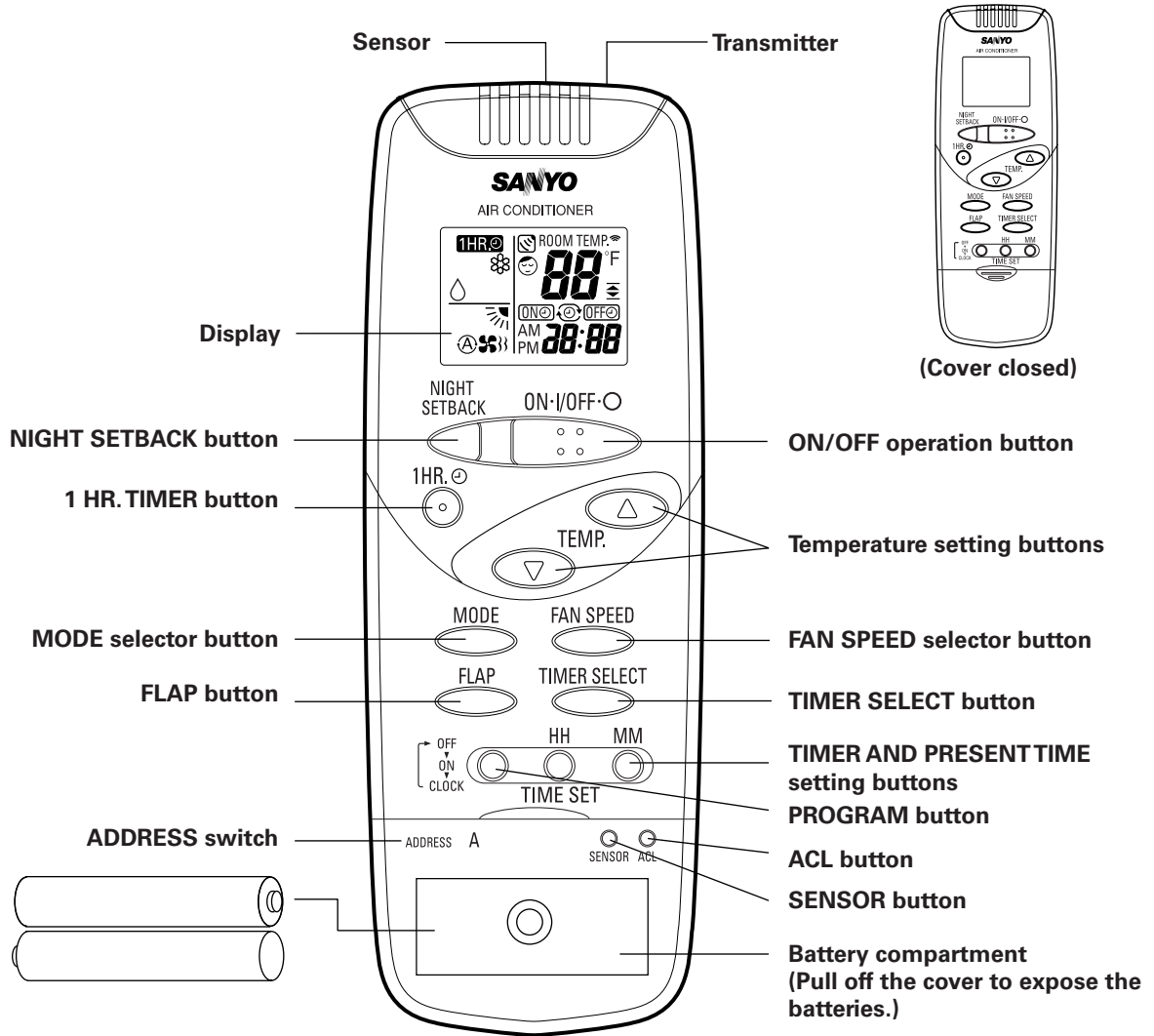

Angle indication..... 

Sweep indication..... 













Remote Control Unit

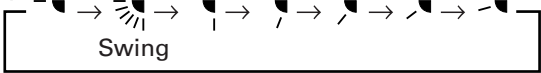

NOTE The illustration above pictures the remote control unit after the cover has been lowered and removed.

Transmitter	When you press the buttons on the remote control unit, the  mark appears in the display to transmit the setting changes to the receiver in the air conditioner.
Sensor	A temperature sensor inside the remote control unit senses the room temperature.
Display	Information on the operating conditions is displayed while the remote control unit is switched on. If the unit is turned off, only the mode that was set previously is still displayed.
NIGHT SETBACK button	For details, see "Night Setback Mode". When you press this button in the DRY or COOL mode, the  mark appears in the display, and the remote control unit automatically adjusts the set temperature to save energy.
Temperature setting buttons (TEMP.)	Press the  button to increase the set temperature. Press the  button to reduce the set temperature.
ON/OFF operation button	This button is for turning the air conditioner on and off.
Timer and Present Time setting buttons	First, press the program button to select the mode you want. Each time you press the "HH" button, the hours advance by one. Each time you press the "MM" button, the minutes advance by one.

Remote Control Unit (continued)

Program button	For details, see "Setting the Timer". Press this button to select the mode you want to program.
TIMER SELECT button	No display : The timer does not operate.  : The air conditioner stops at the set time.  : The air conditioner starts at the set time.  : The air conditioner stops and starts, or starts and stops, at the set times every day.
MODE selector button (DRY) (COOL)	Use this button to select the DRY or COOL mode.  : The air conditioner reduces the humidity in the room.  : The air conditioner makes the room cooler.
FLAP button	Press this button either to select to set the airflow direction to one of the six possible positions manually, or to select the sweep function, which moves the flap up and down automatically.  : The airflow direction can be set manually. (six positions)  : The flap moves up and down automatically. <div style="border: 1px solid black; padding: 5px; width: fit-content;"> <p>NOTE When you press the FLAP button, the air flow direction will be changed one by one as follows.</p>  <p style="text-align: center;">Swing</p> </div>
FAN SPEED selector button	 : The air conditioner automatically decides the fan speeds.  : High fan speed  : Medium fan speed  : Low fan speed
1 HR. TIMER button (1-HOUR OFF TIMER)	 : When you press this button, regardless of whether the unit is operating or stopping, the unit operates for one hour and then shuts down.
ACL button (ALL CLEAR)	Puts the remote control unit into pre-operation status. Always press this button after replacing the batteries.
ADDRESS switch	<ul style="list-style-type: none"> • Change the address switch to prevent mixing of signals from remote control units when two Sanyo air conditioners are installed next to each other. Normally, the address switch is set to A. When switching the address, the remote control must be changed, and the jumper cables on the indoor unit board must be cut. For more information, please contact the dealer where you made the purchase. • Normally, the tabs on the remote control unit should not be bent.
SENSOR button	When you press this button (use a small-tipped object such as a ballpoint pen), the  mark will appear at the display. And the room temperature is detected by the sensor which is built into the indoor unit and the air conditioner is controlled accordingly. <div style="border: 1px solid black; padding: 5px; width: fit-content;"> <p>NOTE If the remote control is located near a heat source, such as a space heater or in direct sunlight, press the SENSOR button to switch to the sensor on the indoor unit.</p> </div>

NOTE The remote control unit sends the temperature signal to the air conditioner regularly at five minute intervals. If the signal from the remote control unit stops for more than ten minutes due to the loss of the remote control unit or other trouble, the air conditioner will switch to the temperature sensor which is built into the indoor unit and control the room temperature. In these cases, the temperature around the remote control unit may differ from the temperature detected at the air conditioner's position.

Using the Remote Control Unit

How to Install Batteries

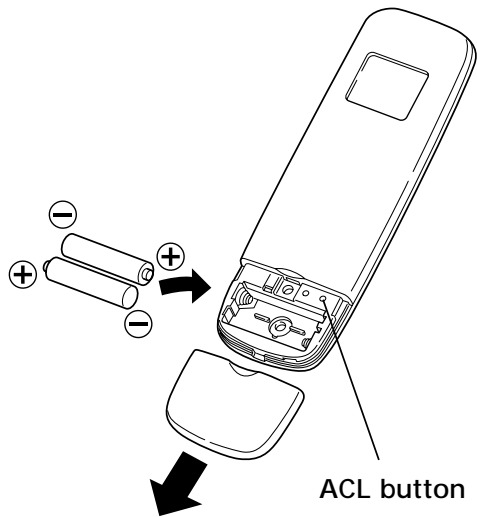

1. Slide the cover in the direction indicated by the arrow and remove it.
2. Install two AAA alkaline batteries. Make sure the batteries point in the direction marked in the battery compartment.
3. Use a thin object such as the tip of a pen to press the ACL button.

NOTE

- The batteries last about six months, depending on how much you use the remote control unit. Replace the batteries when the remote control unit's display fails to indicate, or when the remote control cannot be used to change the air conditioner's settings.
- Use two fresh leak-proof type-AAA alkaline batteries.
- In replacing batteries, follow the instructions as mentioned in the sub-section "How to Install Batteries".
- If you do not use the remote control unit more than 1 month, take out the batteries.

How to Use the Remote Control Unit

When using the remote control unit, always point the unit's transmitter head directly at the air conditioner's receiver.

Air conditioner
(Indoor unit)



Receiver

Remote control
unit

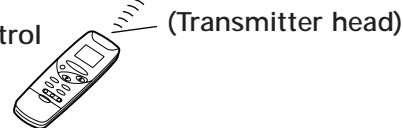

(Transmitter head)

Remote Control Unit Installation Position

The remote control unit may be operated either from a non-fixed position or from a wall-mounted position. To ensure that the air conditioner operates correctly, DO NOT install the remote control unit in the following places:

DO NOT

- In direct sunlight
- Behind a curtain or other places where it is covered
- More than 26 feet (8 m) away from the air conditioner
- In the path of the air conditioner's airstream
- Where it may become extremely hot or cold
- Where it may be subject to electrical or magnetic noise
- Where there is an obstacle between the remote control unit and air conditioner (since a check signal is sent from the remote control unit every 5 minutes)

Using the Remote Control Unit (continued)

Mounting the Remote Control Unit

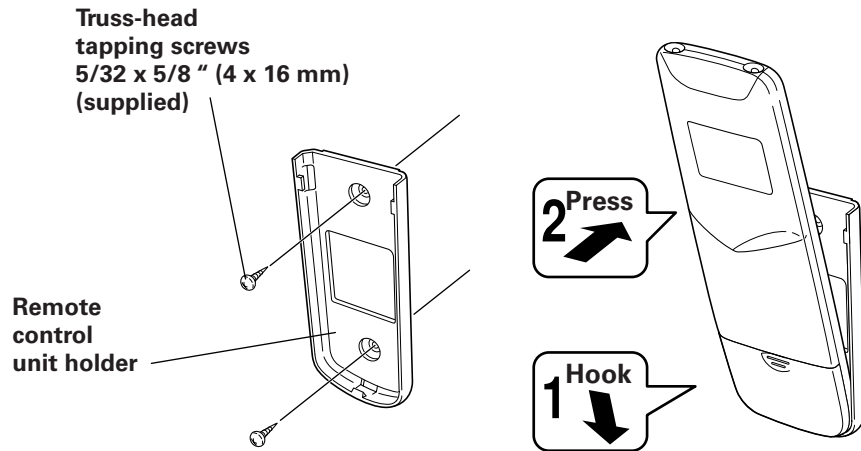

When attaching to wall

- 1) Confirm the indoor unit beeps when the ON/OFF button is pressed at the wall location where the remote control unit is to be attached, then attach the holder to the wall.
- 2) When taking out the remote control unit, pull it from the holder.

When using the remote control unit

- Point the transmitter on the remote control unit at the sensor on the indoor unit when operating the remote control unit and the air conditioner.
- Do not place objects which may block the transmitted signals between the receiver and the remote control unit.

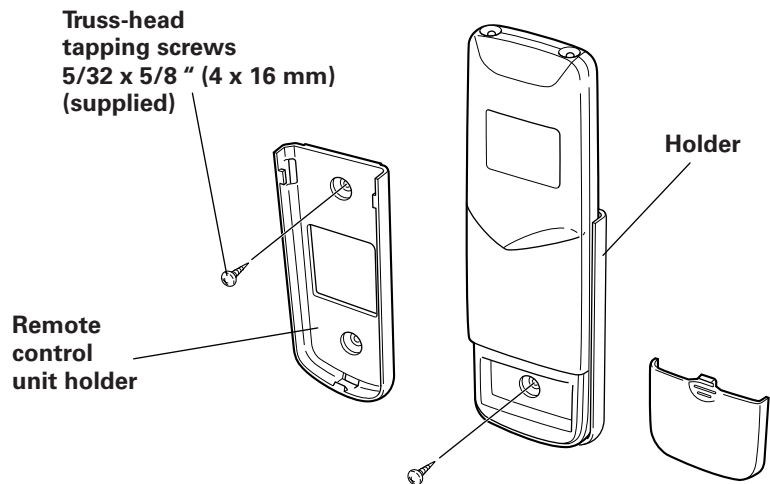

Securing the remote control unit to prevent theft

- 1) Attach the holder to the wall with one screw in the upper hole only.
- 2) Remove the cover from the remote control unit, and then remove the batteries. Next, place the remote control unit in the holder.
- 3) Secure both the remote control unit and the holder to the wall with another screw through the lower hole.
- 4) Put the batteries back in the remote control unit, and then replace the cover.

Operation with the Remote Control Unit

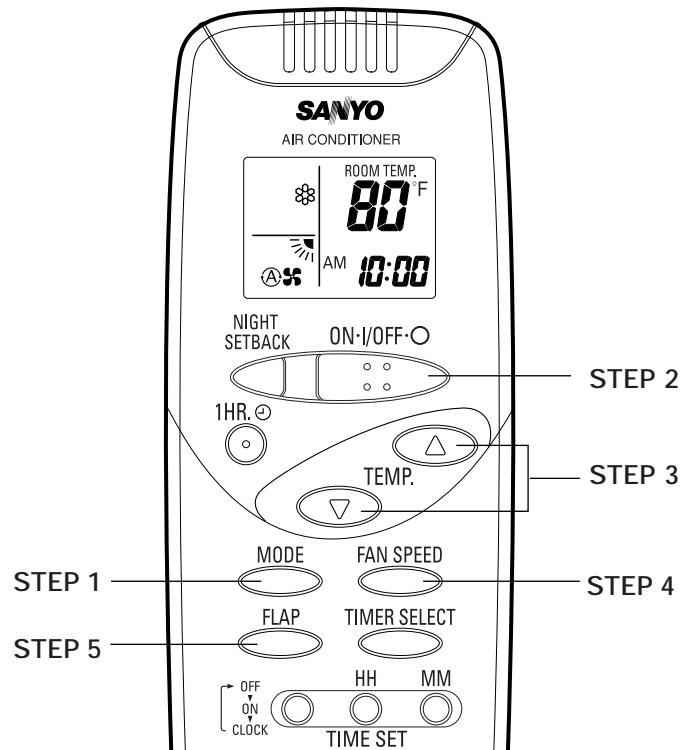

1. Manual Operation



NOTE

Check that the circuit breaker on the power panel is turned on and that the operation selector of the indoor unit is in the ON position.

Press the setting buttons as described below and change the settings as desired.

STEP 1	Press the MODE selector button and select the desired mode. For drying operation →  For cooling operation → 
STEP 2	To start the air conditioner, press the ON/OFF operation button.
STEP 3	Press the temperature setting buttons to change the temperature setting to the desired temperature. Adjustable temperature range: 86 °F max. 60 °F min.
NOTE	The temperature setting changes by two degrees each time the button is pressed. (The air conditioner remembers the new temperature setting even when it is turned off.)
STEP 4	Set the FAN SPEED selector button to the setting you want.
NOTE	If the fan speed is set to  (Automatic), the fan speed switches automatically, according to the difference between the actual room temperature and the temperature setting.
STEP 5	Press the FLAP button and set the airflow direction as desired. (Refer to "Adjusting the Airflow Direction" on page 19.)

To stop the air conditioner, press the ON/OFF operation button again.

Operation with the Remote Control Unit (continued)

NOTE

- This appliance has a built-in three minutes time delay circuit to ensure reliable operation. When the operation button is pressed, the compressor will start running within three minutes. In the event of power failure, the unit will stop. When the power is restored, the unit will restart automatically after five minutes.

2. Adjusting the Fan Speed

A. Automatic

Simply set the FAN SPEED selector button to the  position.

A microcomputer in the air conditioner automatically controls the fan speed when the  mode is selected. When the air conditioner starts operating, the difference between the room temperature and the set temperature is detected by the microcomputer which then automatically switches the fan speed to the most suitable level.



Cooling and DRY mode:

When difference between room temperature and set temperature is	FAN SPEED
4 °F and over	High
Between 4 °F and 2 °F	Medium
Below 2 °F	Low

NOTE

The above mentioned data make reference to the conditioner operating when the sensor on the remote control unit is ON. (Refer to temperature sensor selector). If the sensor on the indoor unit is being used then actual operation will slightly differ from that described in the above tables. ( Sign shown on the remote control unit display.)

B. Manual

If you want to adjust fan speed manually during operation, just set the FAN SPEED selector button as desired. [ ,  , or ]

Operation with the Remote Control Unit (continued)

3. Night Setback Mode

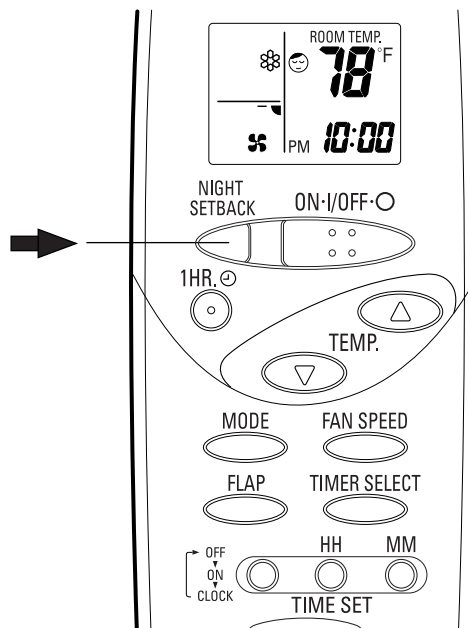

The Night Setback Mode is used for saving energy.

Press the NIGHT SETBACK button while the air conditioner is operating. The ☺ mark appears in the display.

To cancel the night setback function, press the NIGHT SETBACK button again.

In Cooling and DRY
Mode:
(☼ and ☺)

When the night setback mode is selected, the air conditioner automatically raises the temperature setting 2 °F when 30 minutes have passed after the selection was made, and then another 2 °F after another 30 minutes have passed, regardless of the indoor temperature when night setback was selected. This enables you to save energy without sacrificing comfort. This function is convenient when gentle cooling is needed.

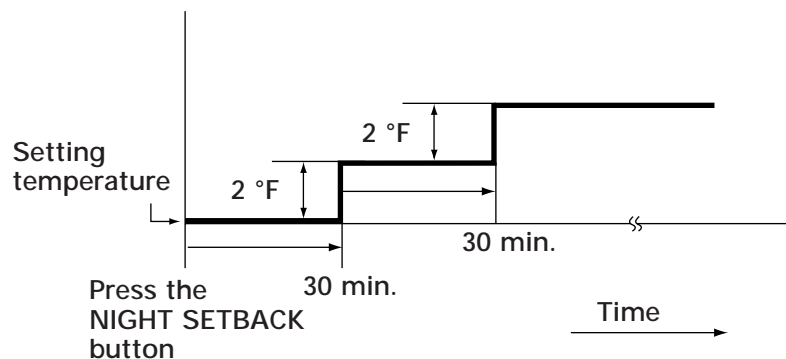

Special Remarks

“DRY” (△) Operation

How it works?

- Once the room temperature reaches the level that was set, the unit repeats the cycle of turning on and off automatically.
- During DRY operation, the fan speed is automatically set to LOW or VERY LOW; the fan speed then switches back and forth between LOW (for 20 seconds) and VERY LOW (for 10 seconds).
- “DRY” operation is not possible if the indoor temperature is 59 °F or less.

Power failure during operation

- In the event of power failure, the unit will stop. When the power is turned on again, the unit restarts within five minutes.

Clicking Sound

Clicking sound is heard from the air conditioner

- In cooling and drying operation, any plastic parts may expand or shrink due to a sudden temperature change. In this event, a clicking sound may occur. This is normal, and the sound will soon disappear.

Remote Control Unit

- The remote control unit sends the setting condition to the air conditioner regularly at five minute intervals.



IMPORTANT

KS1852 and CL1852 Combination

- When this unit is combined with the CL1852 outdoor unit, set the indoor airflow to medium or high when the outdoor temperature drops below 32 °F to prevent condensation from forming at the indoor unit.

Setting the Timer

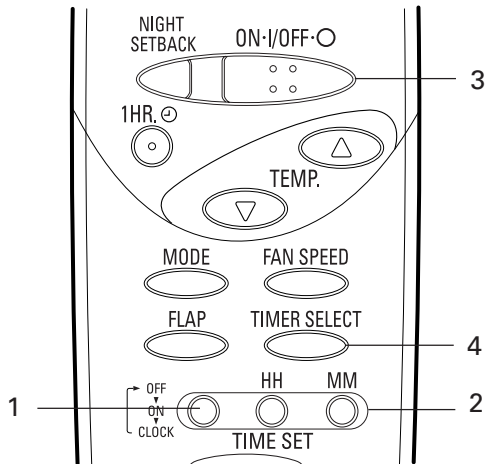

1. How to set the present time

(Example) To set to 9:10 pm.

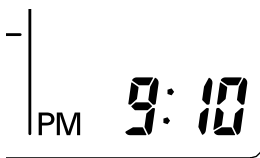



Operation	Indication
1. Press the Program button () three times.	The time indication alone blinks.
2. • Press the HH button until PM 9 is displayed. • Press the MM button until 10 is displayed.	The display will automatically stop blinking except for the ":" symbol after 10 sec.

2. How to set the OFF time

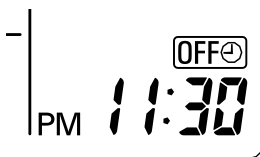
(Example) To stop the air conditioner at 11:30 pm.



1. Press the Program button () once.	The timer  indication blinks and present OFF time is shown.
2. • Press the HH button until PM 11 is displayed. • Press the MM button until 30 is displayed.	The display will change automatically back to show the present time after 10 sec.
3. Press the ON/OFF button to start the air conditioner.	The present time is displayed.
4. Press the TIMER SELECT button to set OFF time.	The present time and  are displayed.

Setting the Timer (continued)

3. How to set the ON time (Example) To start operation at 7:10 am.

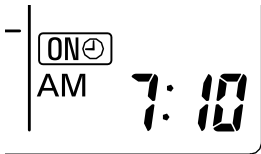

Operation	Indication
1. Press the Program button (OFF, ON, CLOCK) twice.	The timer ON indication blinks and present ON time is shown.
2. • Press the HH button until AM 7 is displayed. • Press the MM button until 10 is displayed.	The display will change automatically back to show the present time after 10 sec.
3. Press the ON/OFF button to start the air conditioner.	The present time is displayed.
4. Press the TIMER SELECT button to set ON time.	The present time and ON are displayed.

4. How to set a program for daily ON/OFF operation

(Example) To start operation at 7:10 am. and stop the air conditioner at 11:30 pm.

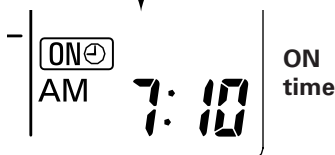
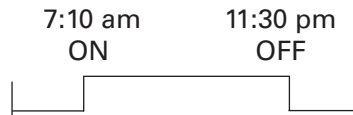

1. Set the timer ON/OFF times as shown in 2-1, 2 and 3-1, 2.	
2. Press the ON/OFF button to start the air conditioner.	
3. Press the TIMER SELECT button to set the ON/OFF combination timer.	The present time PM 9:10 and ON OFF are displayed.

NOTE When the Daily ON/OFF program is set to start the air conditioner before the ON time setting, the ON OFF indications appear on the display.

On the other hand, when the Daily ON/OFF program is set to start the air conditioner after the ON time setting, the ON OFF indications appear on the display. Thus, these indications show the timer program which will operate next.

NOTE You can check the timer ON/OFF times after you have set them by pressing the PROGRAM button.

Setting the 1-Hour OFFTimer

1. 1-Hour OFFTimer

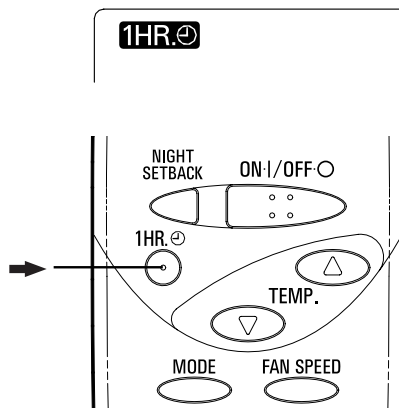

This function causes the unit to operate for one hour and then stop, regardless of whether the unit is on or off when this button is pressed.

The **1HR.** indicator in the display indicates that this function is operating.

Setting procedure:

Regardless of whether the unit is operating or stopped, press the 1 HR. TIMER button.

1HR. appears in the display.

Cancellation procedure:

Press the ON/OFF operation button to turn the unit off, wait for the unit to stop operating, and then press the ON/OFF operation button again. The 1-Hour Timer function is now cancelled and the unit operates normally.

NOTE

- If, while the 1-Hour Timer function is operating, the 1 HR. TIMER button is pressed once to cancel the function and then again, the unit continues to operate for one hour from that point in time and then stops.

2. Operation Together with the Program Timer

- The 1-Hour OFFTimer setting is given priority over the daily program setting.
- It is not possible to use the OFFTimer and 1-Hour OFFTimer together. Whichever function is set last takes precedence. If the 1 HR. TIMER button is pressed while the TIMER OFF function operates, OFFTimer is cancelled and the unit will stop operating one hour later.

Adjusting the Airflow Direction

1. Horizontal

The horizontal airflow can be adjusted by moving the vertical vanes with your hands to the left or right.

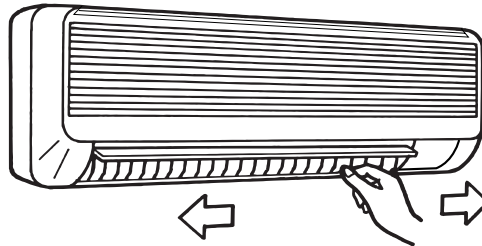

CAUTION

When the humidity is high, the vertical vanes should be in the front position during the cooling or drying operation. If the vertical vanes are positioned all the way to the right or left, condensation may begin to form around the air vent and drip down.

2. Vertical

The vertical airflow can be adjusted by moving the flap with the remote control unit. Do not move the flap with your hands. Confirm that the remote control unit has been turned on. Use the FLAP button to set either the sweep function or one of the six airflow direction settings. (The maximum capacity is obtained at the position at ④.)

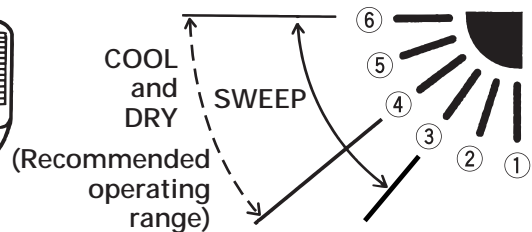
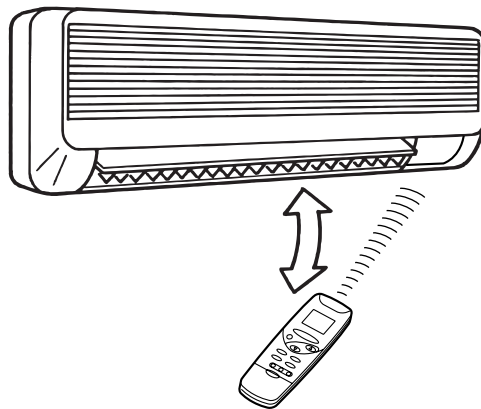
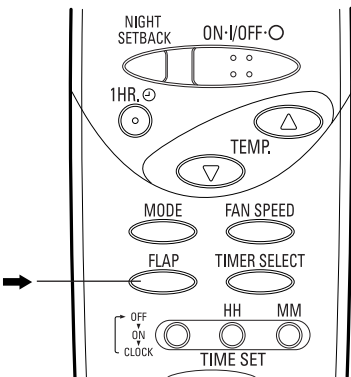

A. Sweep function



The flap starts moving up and down to deliver air over the sweep range.

B. Setting the airflow manually



Referring to the above illustration, use the FLAP button to set the airflow direction within the range used during the cooling, or drying operation.

NOTE

- The flap automatically closes when the unit is off.



CAUTION

- Use the FLAP button on the remote control to adjust the position of the flap. If you move the flap by hand, the flap position according to the remote control and the actual flap position may no longer match. If this should happen, shut off the unit, wait for the flap to close, and then turn on the unit again; the flap position will now be normal again.
- Do not have the flap pointed down during cooling operation. Condensation may begin to form around the air vent and drip down.

Operation without the Remote Control Unit

INDOOR UNIT
KS0951
KS1251

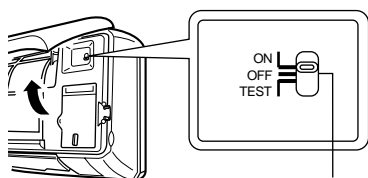

Operation selector

KS1852

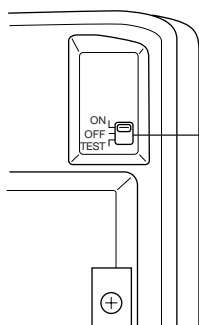

Operation selector

If you have lost the remote control unit or it has trouble, follow the steps below.

1. When the air conditioner is not running
If you want to turn on the air conditioner, switch the operation selector to the OFF position, and then to the ON position.

NOTE

The set temperature and fan speed are automatically set at the last selection before stopping.

2. When the air conditioner is running
If you want to turn off the air conditioner, switch the operation selector to the OFF position.

Care and Cleaning



WARNING

1. For safety, be sure to turn the air conditioner off and also to disconnect the power before cleaning.
2. Do not pour water on the indoor unit to clean it. This will damage the internal components and cause an electric shock hazard.

Casing and Grille
(Indoor Unit)

Clean the casing and grille of the indoor unit with a vacuum cleaner brush, or wipe them with a clean, soft cloth.

If these parts are stained, use a clean cloth moistened with a mild liquid detergent. When cleaning the grille, be careful not to force the vanes out of place.



CAUTION

1. Never use solvents, or harsh chemicals when cleaning the indoor unit. Do not wipe the plastic casing using very hot water.
2. Some metal edges and the fins are sharp and may cause injury if handled improperly; be especially careful when you clean these parts.
3. The internal coil and other components of the outdoor unit must be cleaned every year. Consult your dealer or service center.

Care and Cleaning (continued)

Anti-mold filter

The anti-mold filter behind the air intake grille should be checked and cleaned at least once every two weeks.

How to remove the anti-mold filter

1. Grasp both ends of the air intake grille and pull it out and up.
2. Push the anti-mold filter up slightly, and then pull it down.

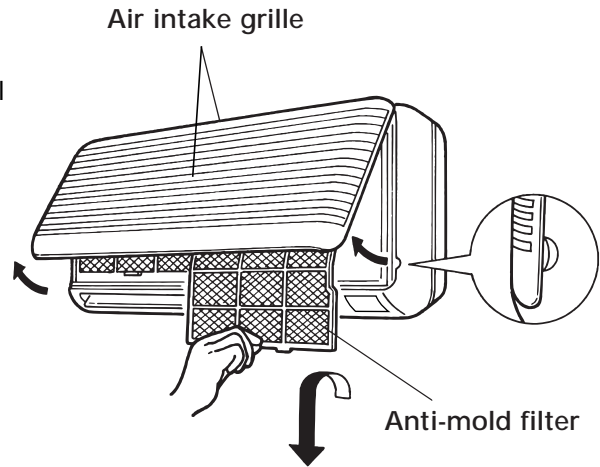

Cleaning

Use a vacuum cleaner to remove light dust. If there is sticky dust on the filter, wash the filter in lukewarm, soapy water, rinse it in clean water and dry it.

How to replace the anti-mold filter

1. With the "FRONT" mark facing you, slide the anti-mold filter up into the unit and then lower the handle into the groove on the unit.
2. After installing the anti-mold filter, press the locations marked by the arrows (↓) and close the air intake grille.

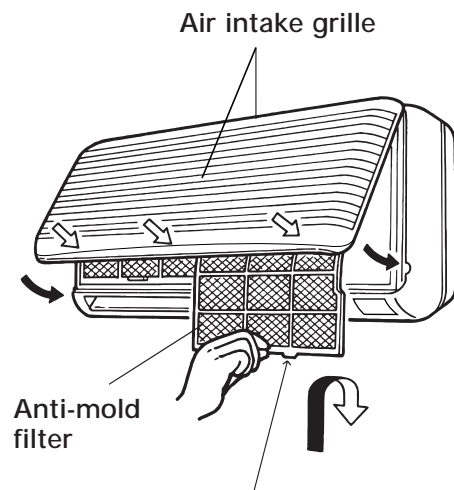

Insert into the groove on the unit.

Care and Cleaning (continued)

Air cleaning filter (not provided)

The air cleaning filter removes dust and dirt from the air, and reduces odors and smoke from tobacco.

NOTE

KS0951/KS1251

The air cleaning filter is not provided with the air conditioner and must be purchased separately. The first time that you buy the air clean filter, it is necessary to get the **STK-ARF4B** model with frame. When changing the filter subsequently, it is only necessary to replace the filter itself (model **STK-F4B**). Do not throw away the filter frame.

KS1852

The air clean filter is not provided with the air conditioner and must be purchased separately.
Ask for the **STK-F4B** model when purchasing.



WARNING

The air cleaning filter cannot remove harmful gases or vapors nor ventilate air in the room. You must open doors or windows frequently when you use gas or oil heating appliances. Otherwise there is a risk of suffocation in extreme cases.

How to install the air cleaning filter

The air cleaning filter needs to be installed behind the anti-mold filter.

1. Remove the anti-mold filter.
2. To mount the **STK-F4B**, set the air clean filter(sold separately) at the mounting position with the black side facing the rear.
To mount the **STK-ARF4B**, mount the air clean filter in the position shown in the diagram with the **(STK-F4B) FRONT** marking facing the front.
3. Reinstall the anti-mold filter, and close the suction grill.

Air clean filter (STK-F4B)

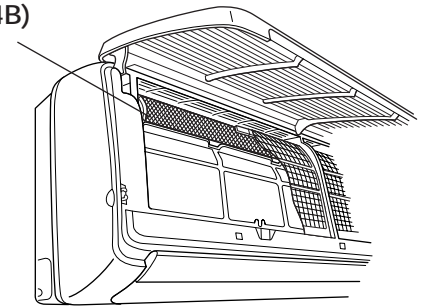

KS1852

NOTE

- In general, the filter should be replaced once every three months.
- Dirty air clean filters cannot be washed and reused. Purchase a replacement filter at your local dealer.

Air clean filter (STK-ARF4B)

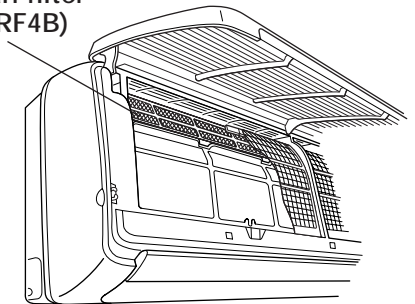

KS0951/KS1251

Cleaning the main unit and remote control unit

- Wipe clean using a soft, dry cloth.
- To remove stubborn dirt, moisten a cloth in warm water no hotter than 104 °F, wring thoroughly, and then wipe.
- The air intake grille can be removed in order to wash it with water.

Care and Cleaning (continued)

Removing and remounting the air intake grille

- With the air intake grille open all the way, grip both arms with your hands and pull toward you to remove. To remount, hold the air intake grille roughly horizontal and push it in until the arm shafts fit into the indentations in the main unit, then fit the grille into place.

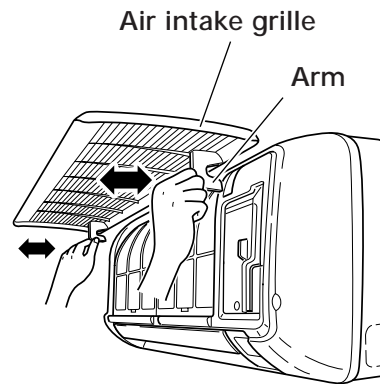

CAUTION

When using a footstool or the like, be careful not to let it tip over.

Washing the grille with water

- Clean the grille gently using a soft sponge, or the like. Then wipe away any remaining moisture.
- Neutral detergent may be used to remove stubborn dirt. Then rinse thoroughly with water and wipe away any remaining moisture.

Tips for Energy Saving

Do not

- **Block the air intake and outlet of the unit. If they are obstructed, the unit will not work well, and may be damaged.**
- Let direct sunlight into the room. Use sunshades, blinds or curtains. If the walls and ceiling of the room are warmed by the sun, it will take longer to cool the room.

Do

- Always try to keep the air filter clean. (Refer to "Care and Cleaning".) A clogged filter will impair the performance of the unit.
- To prevent conditioned air from escaping, keep windows, doors and any other openings closed.

Troubleshooting

If your air conditioner does not work properly, first check the following points before requesting service. If it still does not work properly, contact your dealer or service center.

Trouble	Possible Cause	Remedy
Air conditioner does not run at all.	<ol style="list-style-type: none"> 1. Power failure. 2. Leakage circuit breaker tripped. 3. Line voltage is too low. 4. Operation button is OFF. 5. Batteries in remote control unit have run down. 	<ol style="list-style-type: none"> 1. Restore power. 2. Contact service center. 3. Consult your electrician or dealer. 4. Press the button again. 5. Replace batteries.
OPERATION lamp flashes and air conditioner does not operate.	Trouble in wiring system.	Contact service center.
Compressor runs but soon stops.	Obstruction in front of condenser coil.	Remove obstruction.
Poor cooling performance.	<ol style="list-style-type: none"> 1. Dirty or clogged air filter. 2. Heat source or many people in room. 3. Doors and/or windows are open. 4. Obstacle near air intake or air discharge port. 5. Thermostat is set too high for cooling. 	<ol style="list-style-type: none"> 1. Clean air filter to improve airflow. 2. Eliminate heat source if possible. 3. Shut them to keep the heat out. 4. Remove it to ensure good airflow. 5. Set the temperature lower.
Clicking sound is heard from the air conditioner.	In cooling and drying operation, any plastic parts may expand or shrink due to a sudden temperature change. In this event, a clicking sound may occur.	This is normal, and the sound will soon disappear.
OPERATION lamp lights but outdoor unit will not run.	1. The use of portable telephones near the air conditioner may cause disturbance to its normal operation.	<ol style="list-style-type: none"> 1. Turn off the power then restart the air conditioner after 1 minute. 2. Consult your dealer.

Operating Range

The air conditioner is operable within the temperature ranges as listed below:

	Temperature	Indoor Air Intake Temperature	Outdoor Air Intake Temperature
Cooling Model	Maximum	95 °F DB/71 °F WB	115 °F DB
	Minimum	67 °F DB/57 °F WB	67 °F DB
Low Ambient Temperature Model	Maximum	95 °F DB/71 °F WB	115 °F DB
	Minimum	67 °F DB/57 °F WB	0 °F DB

SANYO FISHER COMPANY
A DIVISION OF SANYO NORTH AMERICA CORPORATION
21605 Plummer Street
Chatsworth, CA 91311 U.S.A.

In Canada
SANYO Canada Inc.
300 Applewood Crescent,
Concord, Ontario,
L4K 5C7, Canada