

# RCA

## USER'S GUIDE

HDreceiverHDreceiverHDrecei  
verHDreceiverHDreceiverHDR  
eceiverHDreceiverHDreceiver  
HDreceiverHDreceiverHDrecei  
verHDreceiverHDreceiverHDR  
eceiverHDreceiverHDreceiver  
HDreceiverHDreceiverHDrecei  
verHDreceiverHDreceiverHDR  
eceiverHDreceiverHDreceiver  
HDreceiverHDreceiverHDrecei  
verHDreceiverHDreceiverHDR  
eceiverHDreceiverHDreceiver  
HDreceiverHDreceiverHDrecei  
verHDreceiverHDreceiverHDR  
eceiverHDreceiverHDreceiver  
HDreceiverHDreceiverHDrecei  
verHDrecei verH  
DreceiverH D  
receiverHD re  
ceiver H  
Drec ei  
verH D  
receiv er  
HDrec ei  
verHD r  
eceiver



# IMPORTANT INFORMATION

## WARNING

To reduce the risk of fire or shock hazard, do not expose this HD receiver to rain or moisture.

## WARNING

RISK OF ELECTRIC SHOCK  
DO NOT OPEN

To reduce the risk of electric shock, do not remove cover (or back). No user serviceable parts inside. Refer servicing to qualified service personnel.



This symbol indicates "dangerous voltage" inside the product that presents a risk of electric shock or personal injury.



This symbol indicates important instructions accompanying the product.

## Cautions

**Do not stack electronic components or other objects on top of the HD receiver.** The slots on top of the receiver must be left uncovered to allow proper airflow to the unit. Blocking the airflow to the unit could impair performance or damage your receiver and other components.

Do not stack the HD receiver on top of a "hot component" such as an audio power amplifier.

FCC Regulations state that unauthorized changes or modifications to this equipment may void the user's authority to operate it. This device complies with part 15 of the FCC rules. Operation is subject to the condition that this device does not cause harmful interference.

### Note to Cable TV Installer:

This reminder is provided to call your attention to Article 820-40 of the National Electrical Code (Section 54 of the Canadian Electrical Code, Part 1) which provides guidelines for proper grounding and, in particular, specifies that the cable ground shall be connected to the grounding system of the building as close to the point of cable entry as practical.

### Note to Satellite Dish Antenna Installer:

This reminder is provided to call your attention to Article 810, and in particular Article 810-15, of the National Electrical Code (which covers proper installation and grounding of television receiving equipment) as well as to Article 820-40, which specifies that the satellite dish antenna cable ground shall be connected to the grounding system of the building as close to the point of cable entry as practical.

## IMPORTANT NOTICE:

This device incorporates an anticopy process technology that is protected by U.S. patents and other intellectual property rights measures. The anticopy process is licensed for non-commercial, home use only. Reverse engineering or disassembly is prohibited.

Due to copyright restrictions, you may not be able to view some high definition programs in high definition format using this product.

### Care and Cleaning:

Use a soft cloth or the dusting attachment of your vacuum cleaner to dust your HD receiver. Remove dust from both top and bottom ventilation holes.

Plastic surfaces are easily scratched and can be marred by alcohol and various solvents. Avoid excessive use of oil-based furniture polishes since the materials used in the cabinet will accumulate more dust. A non-abrasive, anti-static cleaner/polisher is recommended.

### Product Registration:

Please fill out the product registration card and return it immediately. Returning the card allows us to contact you if needed.

Keep your sales receipt to obtain warranty parts and service and for proof of purchase. Attach it here and record the serial and model numbers in case you need them. The numbers are located on the back of the product.

Model No. \_\_\_\_\_

Serial No. \_\_\_\_\_

Purchase Date: \_\_\_\_\_

Dealer/Address/Phone: \_\_\_\_\_

# TABLE OF CONTENTS

<b>WELCOME TO HIGH DEFINITION .....</b>	<b>4</b>
Getting Started .....	4
<b>SETUP AND CONNECTIONS .....</b>	<b>5</b>
Step 1: Unpack the System .....	6
Step 2: Connect Your HD Receiver to Other Components .....	6
Things to Know Before Connecting Components .....	6
Jacks and Cables .....	7
Front of the HD Receiver .....	8
Back of the HD Receiver .....	9
Basic Connection Using a Regular TV or Monitor .....	10
Basic Connection Using a Multimedia or HD Monitor .....	11
Advanced Connection Using a Regular TV or Monitor .....	12
Advanced Connection Using a Multimedia or HD Monitor ..	14
Step 3: Place Batteries in the Remote Control .....	17
Step 4: Plug in and Turn on the System .....	17
Step 5: Run Interactive Setup .....	17
Step 6: Select a Screen Format .....	17
Step 7: Connect the VCR Controller .....	18
How to Locate the VCR's Remote Control Sensor .....	18
How to Select a VCR Type .....	19
Step 8: Order Programming .....	20
<b>USING THE REMOTE .....</b>	<b>21</b>
Remote Control Buttons .....	22
Programming the Remote Control .....	24
Remote Control Codes .....	25
Using the Remote to Control a Component .....	25
<b>BASIC OPERATION .....</b>	<b>27</b>
About The Channel Banner .....	28
Changing Between DIRECTV and TV Viewing .....	29
Changing Channels .....	30
<b>USING THE PROGRAM GUIDES .....</b>	<b>31</b>
Bringing Up the Program Guides .....	32
Anatomy of the TV Program Guide .....	33
Anatomy of the DIRECTV Program Guide .....	34

# TABLE OF CONTENTS

Tuning to a Program .....	35
Getting Around in the Guides .....	35
Using the GUIDE Button .....	36
The Other Guides Icon .....	37
Exiting A Program Guide .....	38
Sorting the DIRECTV® Programming Guide .....	38
The Other Icons .....	42
<b>AUDIO CONTROLS AND TIMERS .....</b>	<b>43</b>
Audio Controls .....	44
Optical Output .....	44
SAP (Second Audio Program) .....	46
Audio Language .....	46
Timers Feature .....	47
Setting Up Timer Recordings .....	47
Recording with Timer .....	47
Schedule a Timer with the RECORD Button .....	48
<b>USING PROFILES .....</b>	<b>49</b>
About Profiles .....	50
The DIRECTV Setup .....	50
Editing Channels in a DIRECTV List .....	50
Selecting or Deleting All DIRECTV Channels .....	51
Setting the DIRECTV Spending Limit .....	51
Setting the DIRECTV Rating Limit .....	52
The TV Setup .....	53
Editing Channels in a TV List .....	53
Selecting or Deleting All TV Channels .....	53
Setting the TV Rating .....	54
The Rating Limit Screen .....	55
Blocking Age-Based Ratings .....	56
Setting the Movie Rating .....	58
Blocking Unrated TV Shows .....	59
Viewing Hours .....	60
Choosing Your Profile .....	60
Locking and Unlocking a User Profile .....	61
Locking the System .....	62
Unlocking the System .....	62

# TABLE OF CONTENTS

<b>SYSTEM OPTIONS AND PREFERENCES</b> .....	<b>63</b>
Changing the Signal Source .....	64
Changing the Signal Type .....	64
Channel Search .....	65
Set VCR Type .....	65
Mailbox .....	66
Purchases: Pay Per View Programs .....	67
Setting the Time and Date .....	69
Choosing an Output Channel .....	70
Using the Preferences Menu .....	70
Color Scheme .....	70
Translucency .....	70
Default Guide.....	70
Screen Format .....	71
Caption Display .....	71
Caption Mode .....	72
Using Fetch .....	72
<b>GETTING ASSISTANCE</b> .....	<b>73</b>
Running the Interactive Setup .....	74
Getting Antenna Information .....	75
Selecting Dish Type.....	75
Find Your Dish Pointing Coordinates .....	76
Using the On-Screen Signal Meter .....	77
Your New Access Card .....	78
Running the System Test.....	78
<b>REFERENCE</b> .....	<b>79</b>
Troubleshooting .....	80
RCA High Definition (HD) Digital Receiver Limited Warranty .....	82
FCC Registration Information .....	84
Accessory Information .....	86
Index .....	90

# WELCOME TO HIGH DEFINITION

High Definition refers to a new way of sending programming information over the airwaves and into your TV. There are two types of display formats available: one is ATSC format (originating from the Advanced Television Systems Committee). The other is NTSC format (named for the National Television Systems Committee). What makes your High Definition receiver special is that it has tuners capable of receiving three types of signals: analog (in NTSC format) and digital (in ATSC format), cable (in NTSC and ATSC formats), and digital satellite (coming from DIRECTV if you subscribe to DIRECTV® programming†). With the advent of digital terrestrial broadcast, your HD receiver makes receiving all types of signals seamless. Below is an example of how you can receive the different types of signals.

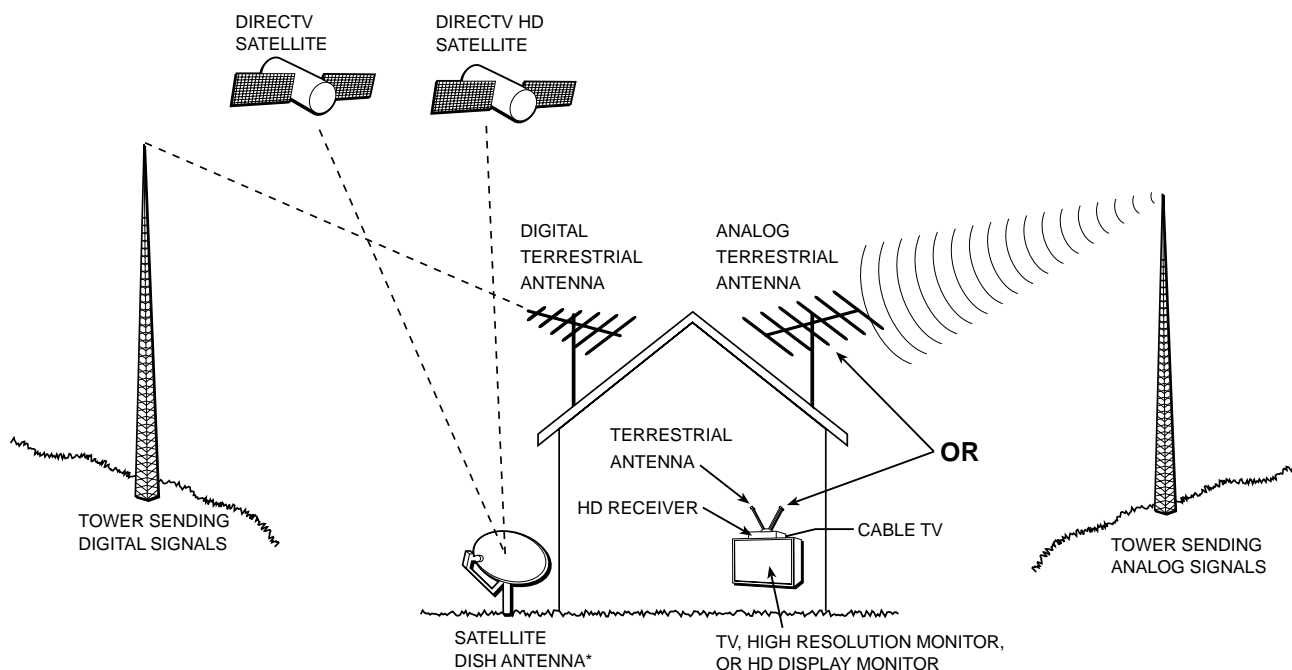

## GETTING STARTED

Now that you have an understanding of what your HD receiver can do, read on to find necessary information about how to use it. The first section of this manual shows you how to connect components and speakers. The "Basic Operation" section describes how you receive the three signals and your viewing options: TV and DIRECTV. The rest of this manual describes how to use your HD receiver's many features, such as program guides, profiles, and system options.

† DIRECTV® programming is provided in accordance with the terms and conditions of the DIRECTV Customer Agreement, a copy of which is provided with your first DIRECTV billing statement. DIRECTV is a trademark of DIRECTV, Inc., a unit of Hughes Electronics Corp., and is used with permission.

\* The appearance of your satellite dish antenna may differ from that shown here. If your satellite dish antenna is round instead of oval, you can receive programming from only the DIRECTV satellite.

# SETUP AND CONNECTIONS

## GETTING STARTED

This section tells you how to get your HD receiver setup and connected. It describes the cables you will need, explains the front and back panels, and walks you through the steps needed to start using your HD receiver.

**1** SETUP AND CONNECTIONS



**2** USING THE REMOTE



**3** BASIC OPERATION



**4** USING THE PROGRAM GUIDES



**5** AUDIO CONTROLS AND TIMERS



**6** USING THE PROFILES



**7** SYSTEM OPTIONS AND PREFERENCES



**8** GETTING ASSISTANCE



**9** REFERENCE

# SETUP AND CONNECTIONS

## STEP 1: UNPACK THE SYSTEM

Make sure to locate the remote control and the other cables that are included with your HD receiver.

## STEP 2: CONNECT YOUR HD RECEIVER TO OTHER COMPONENTS

During the satellite dish antenna installation, your HD receiver may have been connected with just a coaxial cable for the system test. Depending on the components you have, another connection may provide better picture and audio quality. The following sections provide cable and connection information to help you decide what connection is best for you.

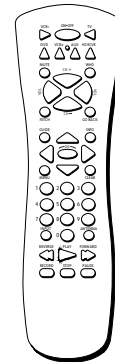

*Remote Control*

## THINGS TO KNOW BEFORE CONNECTING COMPONENTS

### Protect Your Components from Power Surges

- Connect all components before plugging any power cords into the wall outlet.
- Always turn off the TV and other components before you connect or disconnect any cables.

### Position Cables Correctly to Avoid Audio Hum or Interference

- Insert all cable plugs firmly into their jacks.
- Place the Audio/Video cables to the sides of the TV's back panel instead of straight down the middle after you connect your components.
- Try not to coil any twin-lead cables; keep them away from the Audio/Video cables as much as possible.
- Make sure all antennas and cables are properly grounded. Refer to the safety sheet packed with your unit.

### Protect Your Components from Overheating

- Do not block ventilation holes in any of the components. Arrange the components so that air can circulate freely.
- Do not stack components.
- Allow adequate ventilation when placing your components in a stand.
- Place an amplifier on the top shelf of the stand so that heated air rising from it will not flow around other components.



# SETUP AND CONNECTIONS

## JACKS AND CABLES

Below is a description of the jacks and cables you can use to make connections. Note that not all cables come with your HD receiver.

### S-Video Jack and Cable

The S-Video jack is available on this HD receiver and is used in conjunction with audio cables. Remember also to connect the left and right audio cables because the S-Video jack carries only the picture signal, not the sound.

### Audio/Video Jacks and Cables (RCA-type)

The Audio/Video jacks provide very good picture and stereo sound quality. They are used for most Audio/Video connections between components. The Audio/Video jacks are often color coded (yellow for video, red for right audio, and white for left audio). If your component has only one input for audio (mono), connect it to the left (white L/MONO) audio jack on the HD receiver.

### RF Jacks and Coaxial Cables (F-type)

The RF jacks are necessary for reception of off-air broadcasts, cable, and DIRECTV signals. These jacks are also required for antenna or cable connections. The RF and coaxial jacks on the HD receiver are labeled SATELLITE IN, ANTENNA A IN, ANTENNA B IN, and OUT TO TV. An RG-6 coaxial cable is required for all satellite signal distribution.

### Optical Jack and Cables

The optical cable and DIGITAL AUDIO OUT jack are used for connecting a Dolby Digital receiver. If you own a Dolby Digital receiver that uses an optical cable-type input, use an optical cable to connect the HD receiver to that receiver.

### Telephone Jack and Cord

The telephone line cord is required to connect your HD receiver to a phone line. If you choose to subscribe to DIRECTV® programming, some services require this phone line connection. The phone line connection is used to periodically call out to DIRECTV. You will need an RJ11 type modular jack, which is the most common type of phone jack and might look like the one pictured here. If you don't have a modular jack, call your local telephone company to find out how to get one installed.

### VCR Controller Jack and Cable

The VCR controller cable plugs into a jack on the HD receiver's back panel. The other end of the cable affixes to your VCR's remote sensor.

### HD Monitor Out Jack and VGA Cable

A VGA cable connects the HD receiver to an industry-standard RGB-compatible monitor via the HD MONITOR OUT jack.

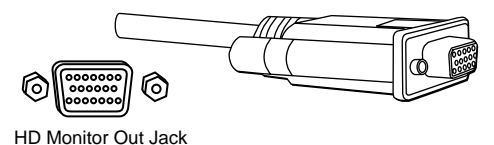
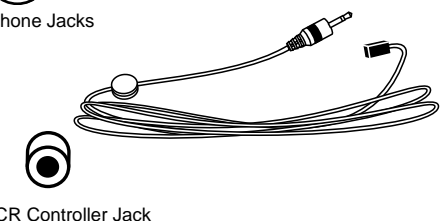
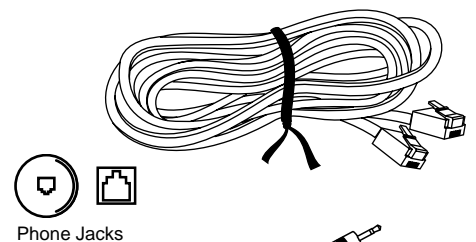
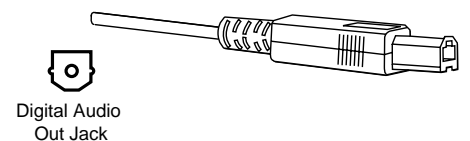
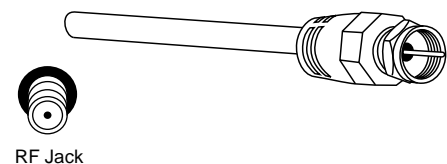
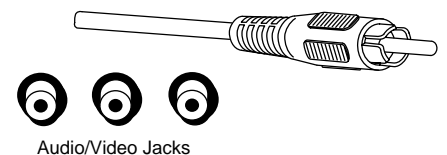
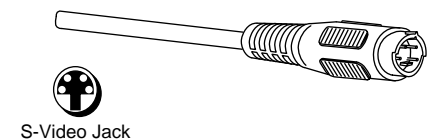

# SETUP AND CONNECTIONS

## FRONT OF THE HD RECEIVER

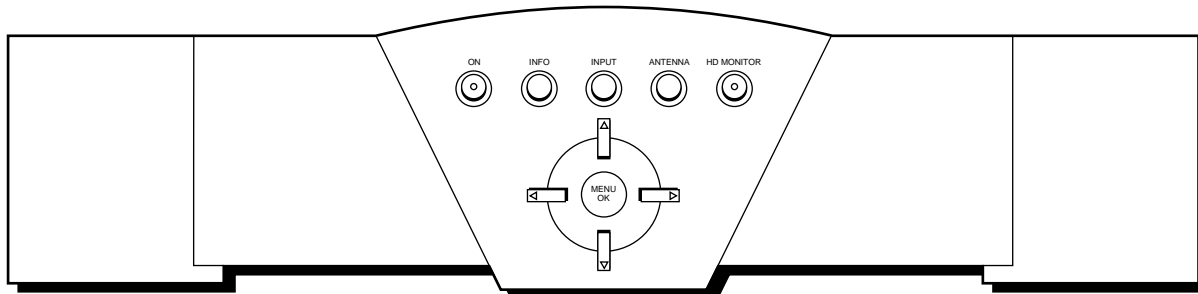

**ON** Turns the HD receiver on and off.

**INFO** Brings up the on-screen channel banner. Press when in the program guide to get more information on the highlighted program or channel.

**INPUT** Toggles between TV and DIRECTV viewing.

**ANTENNA** Switches the source of the off-air signal between ANTENNA A and B.

**HD MONITOR** If you have connected the HD MONITOR OUT jack to your TV or monitor as well as Audio/Video jacks, this button allows you to toggle between viewing signals via the HD MONITOR OUT jack and signals via the Audio/Video jacks.

**MENU/OK** Brings up the main menu. When in the menu system, it selects highlighted items.

> When in the menu system, > moves the highlight right.

< When in the menu system, < moves the highlight left.

v Scrolls down through the current channel list. If you are viewing TV programming and press CHv, you scroll down through TV channels. If you subscribe to and are viewing DIRECTV® programming, you scroll down through DIRECTV channels. In the menu system, v moves the highlight down.

^ Scrolls up through the channel list. If you are viewing TV programming and press ^, you scroll up through TV channels. If you subscribe to and are viewing DIRECTV® programming, you scroll up through DIRECTV channels. In the menu system, ^ moves the highlight up.

If you cannot find your remote control, you can use the front panel of the HD receiver to operate many of the receiver's features.

# SETUP AND CONNECTIONS

## BACK OF THE HD RECEIVER

The diagram below describes each of the back panel jacks found on the HD receiver. When connecting A/V cables, be sure to connect corresponding outputs and inputs (video to video, right audio to right audio, etc.).

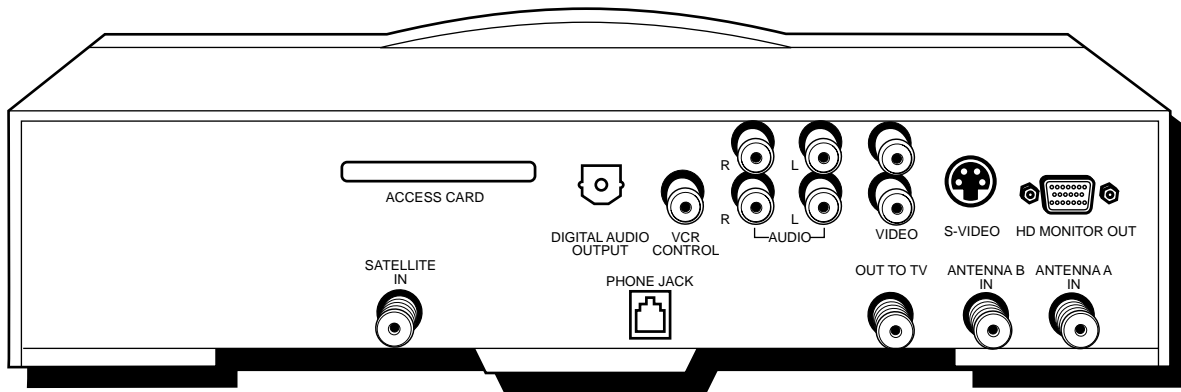

**ACCESS CARD** Insert the access card into the slot so your program provider can identify you. Open the door by pressing the two top tabs and pulling down on the silver cover. Make sure the contacts on the access card are on the bottom of the card while inserting. (Refer to “New Access Card” in this manual’s “Assistance” section for details.) The DIRECTV System requires a valid card.

**DIGITAL AUDIO OUTPUT** Use a digital optical cable (or SPDIF cable) to connect your HD receiver to a compatible Dolby Digital receiver or decoder. Dolby Digital offers theatre-quality sound (six audio channels).

**VCR CONTROL** Allows the HD receiver to control your VCR for one-button recording.

**AUDIO (R and L)** Provide better sound quality than the OUT TO TV jack. If your monitor has Audio/Video capability, use these jacks to connect the HD receiver to your TV or monitor. You must also connect either the VIDEO or S-VIDEO jack.

**VIDEO** Provides better picture quality than the OUT TO TV jack. If your TV or monitor has Audio/Video capability, use this jack to connect the HD receiver. You must also connect the AUDIO jacks.

**S-VIDEO** Provides good picture quality. If your TV or monitor has S-Video capability, use this jack along with the Audio/Video jacks to connect the HD receiver to your monitor.

**HD MONITOR OUT** Use to connect an RGB-compatible high definition monitor. This provides high definition picture quality when high definition broadcasts are viewed. Due to copyright restrictions, you may not be available to view some high definition programs in high definition format using this product.

**SATELLITE IN** Use to connect the satellite dish antenna to the HD receiver.

**PHONE JACK** Use to connect a phone line to the HD receiver to enable some DIRECTV services.

**OUT TO TV** Use to connect the HD receiver to your TV, monitor, or antenna connection.

**ANTENNA B IN** Use to connect an off-air/ terrestrial antenna or cable TV signal to the HD receiver.

**ANTENNA A IN** Use to connect a second off-air/ terrestrial antenna or cable TV signal to the HD receiver.

The VIDEO and S-VIDEO outputs are disabled when you press and illuminate the front panel HD MONITOR output button.

# SETUP AND CONNECTIONS

## BASIC CONNECTION USING A REGULAR TV OR MONITOR

### HD Receiver and Regular TV or Monitor

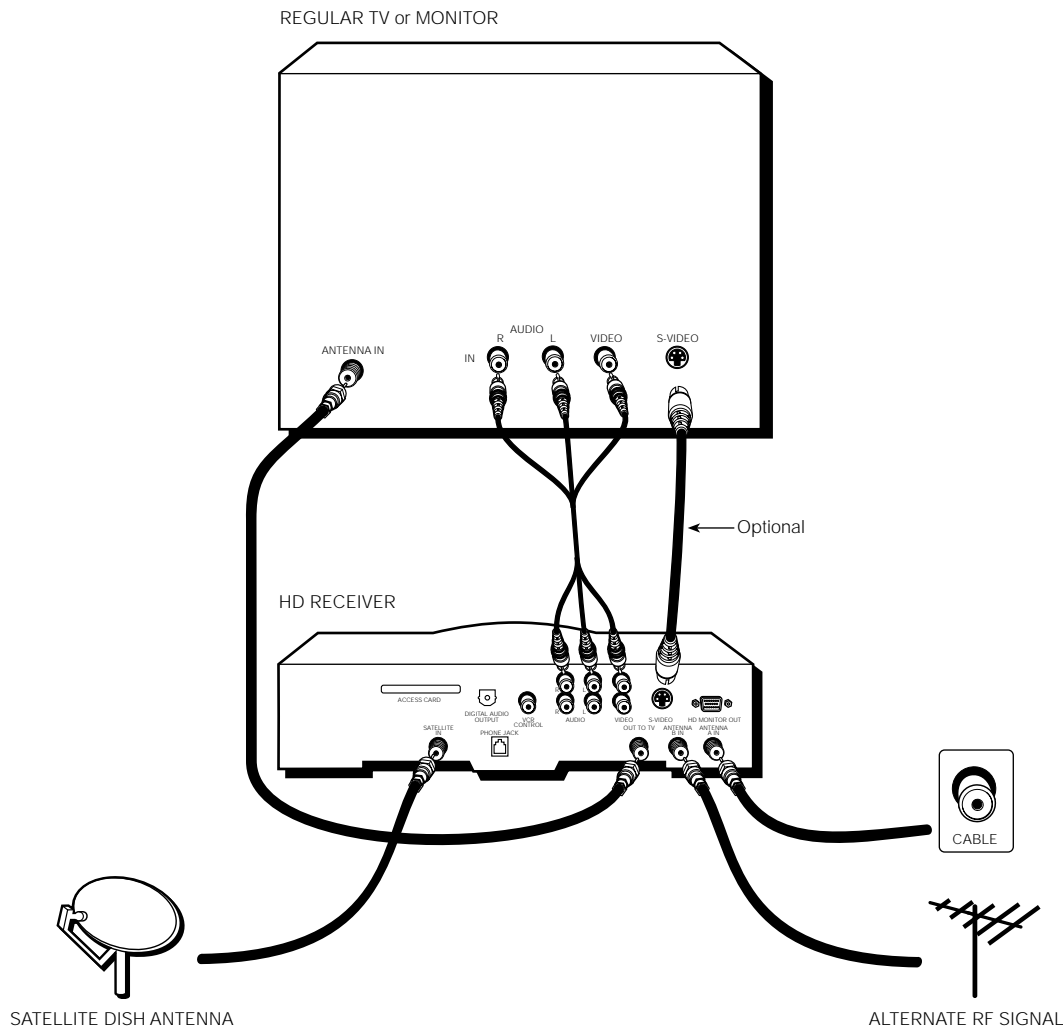

#### CAUTION

Do not stack electronic components or other objects on top of the HD receiver. See Safety Information on the inside cover for details.

The ANT B and ANT A jacks can receive both digital and analog RF signals.

#### To make the connection:

1. Connect Audio/Video and S-Video cables (optional).
  - Connect an Audio/Video cable from the HD receiver's AUDIO Right, Left, and VIDEO jacks to the AUDIO IN Right, Left, and VIDEO jacks on the back of the TV or monitor.
  - Connect the S-Video cable from the HD receiver's S-VIDEO jack to the TV's S-VIDEO jack.
2. Connect coaxial cables.
  - Connect a coaxial cable from the ANTENNA A (or B) jack on your HD receiver to your cable outlet, cable box, or antenna. If desired, connect another coaxial cable from the vacant ANTENNA jack on the HD receiver to another RF signal.
  - Connect a coaxial cable from your HD receiver's SATELLITE IN jack to the satellite dish antenna.
  - Connect a coaxial cable from your HD receiver's OUT TO TV jack to the TV's input jack, usually labeled ANTENNA IN.

# SETUP AND CONNECTIONS

## BASIC CONNECTION USING A MULTIMEDIA OR HD MONITOR

### HD Receiver and Multimedia or HD Monitor

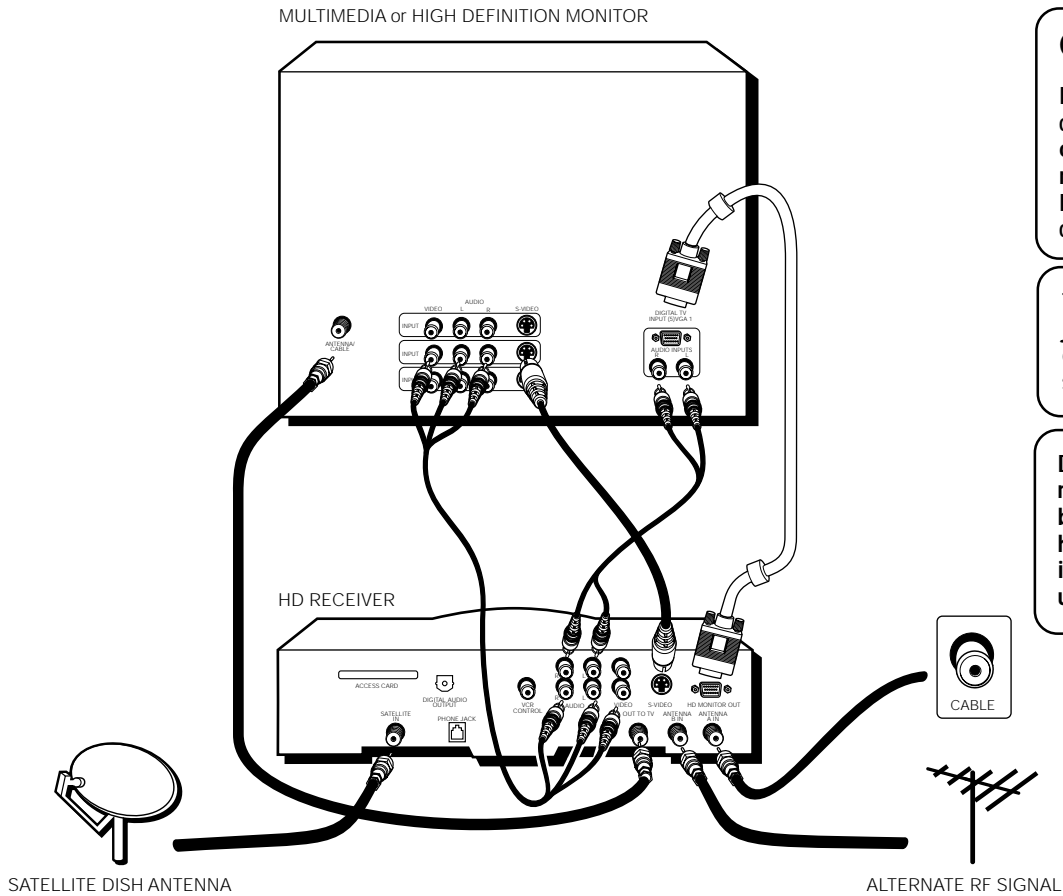

**CAUTION**

Do not stack electronic components or other objects on top of the HD receiver. See Safety Information on the inside cover for details.

The ANT B and ANT A jacks can receive both digital and analog RF signals.

Due to copyright restrictions, you may not be able to view some high definition programs in high definition format using this product.

### To make the connection:

1. Connect Audio/Video and S-Video cables.
  - Connect an Audio/Video cable from the HD receiver's AUDIO Right, and Left, and VIDEO jacks to the AUDIO IN Right, Left, and VIDEO jacks on the Multimedia or HD monitor.
  - Connect an Audio cable from the HD receiver's AUDIO Right and Left jacks to the Multimedia VGA Left and Right Audio inputs.
  - Connect an S-Video cable from the HD receiver's S-VIDEO jack to the Multimedia or HD monitor's S-VIDEO jack.
2. Connect the VGA cable.
  - Connect a VGA cable from the HD receiver's HD MONITOR OUT jack to the Multimedia or HD monitor's VGA input jack, usually labeled DIGITAL TV INPUT (S)VGA.
3. Connect coaxial cables.
  - Connect a coaxial cable from the ANTENNA A (or B) jack on the HD receiver to your cable outlet, box, or antenna. If desired, connect another coaxial cable from the vacant ANTENNA jack on the HD receiver to another RF signal.
  - Connect a coaxial cable from your HD receiver's SATELLITE IN jack to the satellite dish antenna.
  - Connect a coaxial cable from the HD receiver's OUT TO TV jack to the TV's input jack, often labeled ANTENNA/CABLE.

# SETUP AND CONNECTIONS

## ADVANCED CONNECTION USING A REGULAR TV OR MONITOR

### HD Receiver, Regular TV or Monitor, and VCR

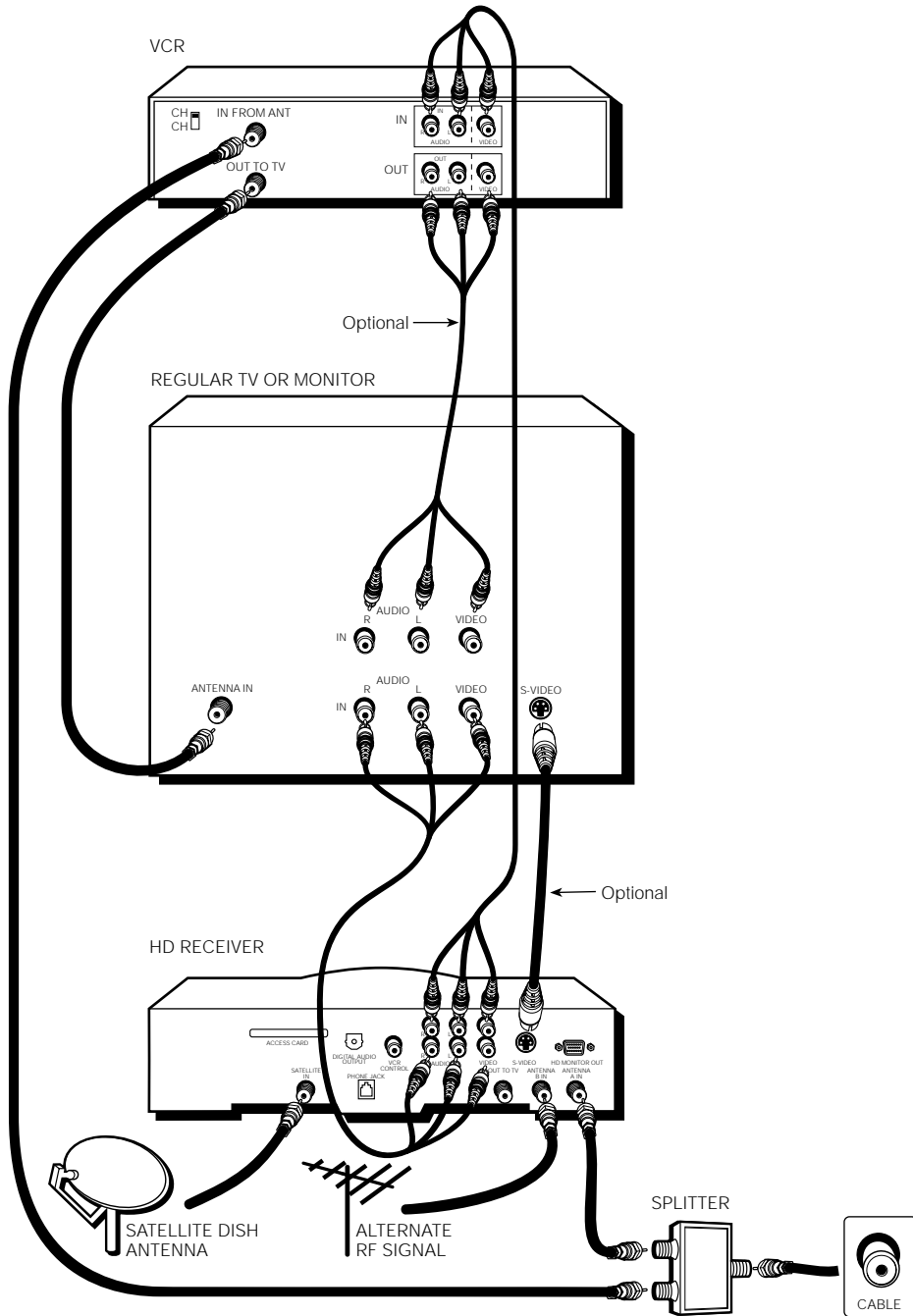

### CAUTION

Do not stack electronic components or other objects on top of the HD receiver. See Safety Information on the inside cover for details.

The ANT B and ANT A jacks can receive both digital and analog RF signals.

# SETUP AND CONNECTIONS

## To make the connection:

1. Connect Audio/Video and S-Video cables (optional).
  - Connect an Audio/Video cable from the HD receiver's AUDIO Right, Left, and VIDEO jacks to the AUDIO IN Right, Left, and VIDEO jacks on the back of the TV or monitor.
  - Connect an S-Video cable from the HD receiver's S-VIDEO jack to the TV's S-VIDEO jack.
  - Connect an Audio/Video cable from the HD receiver's second set of AUDIO Right, and Left, and VIDEO jacks to the second set of AUDIO IN Right, Left, and VIDEO jacks on the VCR.
2. Connect coaxial cables.
  - Connect a coaxial cable from the ANTENNA A (or B) jack on your HD receiver to one output of a splitter. Then use another coaxial cable to connect the input jack on the VCR, usually labeled IN FROM ANTENNA, to the other output of the splitter. Connect the input of the splitter to your cable outlet, cable box, or antenna using a third coaxial cable. If desired, connect another coaxial cable from the vacant ANTENNA jack on the HD receiver to another RF signal.
  - Connect a coaxial cable from your HD receiver's SATELLITE IN jack to the satellite dish antenna.
  - Connect a coaxial cable from your TV's antenna input jack, usually labeled ANTENNA IN, to the VCR's output jack, usually labeled OUT TO TV.

# SETUP AND CONNECTIONS

## ADVANCED CONNECTION USING A MULTIMEDIA OR HD MONITOR

### HD Receiver, Multimedia or HD Monitor, and VCR

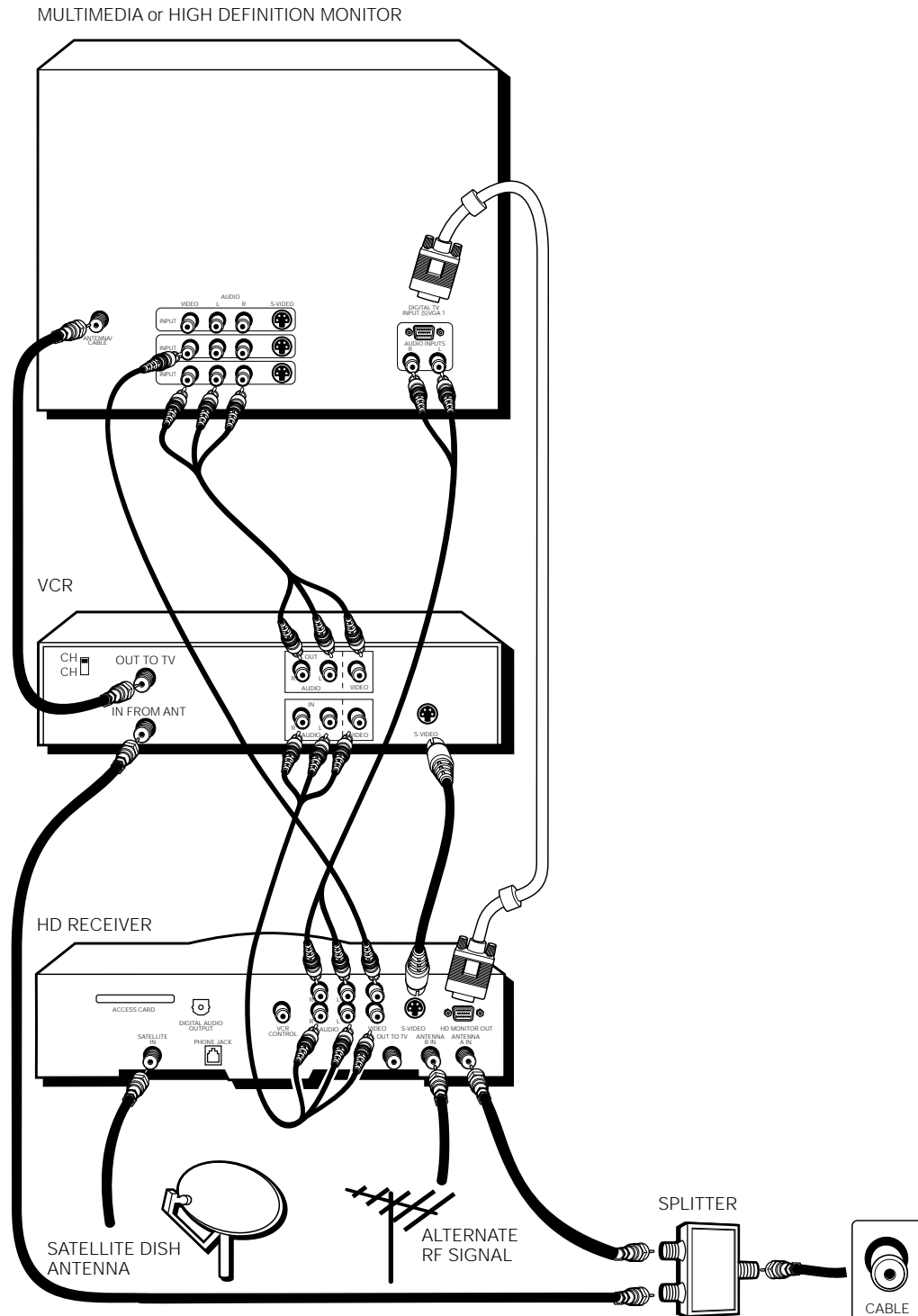

#### CAUTION

Do not stack electronic components or other objects on top of the HD receiver. See Safety Information on the inside cover for details.

The ANT B and ANT A jacks can receive both digital and analog RF signals.

Due to copyright restrictions, you may not be able to view some high definition programs in high definition format using this product.



# SETUP AND CONNECTIONS

## To make the connection:

1. Connect Audio/Video and S-video cables.
  - Connect an Audio/Video cable from the HD receiver's AUDIO Right, and Left, and VIDEO jacks to the VCR's AUDIO IN Right, Left, and VIDEO jacks.
  - Connect an Audio cable from the HD receiver's AUDIO Right and Left jacks to the Multimedia VGA Left and Right Audio inputs. Connect a Video cable from the HD receiver's VIDEO jack to the Multimedia or HD monitor's VIDEO input jack.
  - (Optional) Connect an Audio/Video cable from the VCR's second AUDIO Right, and Left, and VIDEO jacks to the Multimedia or HD monitor's AUDIO IN Right, Left, and VIDEO jacks.
  - (Optional) Connect an S-video cable from the HD receiver's S-VIDEO jack to the VCR's S-VIDEO jack.
2. Connect the VGA cable.
  - Connect a VGA cable from the HD receiver's HD MONITOR OUT jack to the Multimedia or HD monitor's VGA input jack, usually labeled DIGITAL TV INPUT (S)VGA.
3. Connect coaxial cables.
  - Connect a coaxial cable from the ANTENNA A (or B) jack on your HD receiver to a splitter. Then use another coaxial cable to connect the input jack on the VCR, usually labeled IN FROM ANTENNA, to the other jack on the splitter. Connect the splitter to your cable outlet, cable box, or antenna using a third coaxial cable. If desired, connect another coaxial cable from the vacant ANTENNA jack on the HD receiver to another RF signal.
  - Connect a coaxial cable from your HD receiver's SATELLITE IN jack to the satellite dish antenna.
  - Connect a coaxial cable from your VCR's OUT TO TV jack to the Multimedia or HD monitor's ANTENNA/CABLE jack.

### Please Read Before Using the Digital Audio Out Jack

This HD receiver's optical digital output jack fully complies with the international standard governing this type of jack (IEC958), and is designed for connection to a Dolby Digital decoder. Older equipment, some of which is not fully compliant with IEC958, may not be compatible with the Dolby Digital bitstream. Such a connection using anything other than a PCM, Dolby Digital, or Dolby Pro Logic receiver or decoder could create a high noise level, causing damage to headphones or speakers. For more information about Dolby Digital, see the section "Audio Controls and Timers."

# SETUP AND CONNECTIONS

## TO WATCH TELEVISION OR DIRECTV® PROGRAMMING:

1. Tune your TV or monitor to the appropriate input channel.

If you have used Audio/Video cables to connect the HD receiver to the TV, choose an input channel such as INPUT or VIDEO. If you have used a coaxial cable to connect the OUT TO TV jack on the HD receiver to the TV or monitor and did not use Audio/Video cables, tune your TV or monitor to the appropriate output channel—usually Channel 3. (You may change the output channel from 3 to 4 by choosing *System Options* from the HD receiver's main menu, then choosing *Output Channel*. If you do so, tune the TV or monitor to channel 4.)

2. Press the HD RCVR button on the remote control to turn on your HD receiver.

3. **If you are using a regular TV or monitor:**

Make sure the HD receiver is not in HD monitor mode. To make sure you are not in HD monitor mode, check to see that the light on the front panel button labeled HD MONITOR is **not** illuminated. If it is illuminated, press the button to turn off the light.

### **If you are using a Multimedia or HD monitor:**

Make sure the HD receiver is in HD monitor mode. To make sure you are in HD monitor mode, check to see that the light on the front panel button labeled HD MONITOR is illuminated. If it is not illuminated, press the button to turn on the light.

4. To view DIRECTV® programming (if you subscribe):

Press INPUT on the remote control until the DIRECTV icon is highlighted in the channel banner.

5. To view television programming:

Press INPUT on the remote control until the TV icon is highlighted in the channel banner. Note that some cable systems may require a "conversion box." If so, consult your cable company's box tuning instructions for details.

- To watch the signal being received via the ANTENNA A jack on the HD receiver, press the ANTENNA button on the remote until ANTENNA A appears in the banner.
- To watch the signal being received via the ANTENNA B jack on the HD receiver, press the ANTENNA button on the remote until ANTENNA B appears in the banner.



*DIRECTV highlighted in the channel banner indicates you are viewing DIRECTV channels.*



*TV highlighted in the channel banner indicates you are viewing TV channels.*

## TO WATCH YOUR VCR:

- Tune the TV or monitor to the VCR output channel (usually channel 3, 4, VID, VIDEO, or INPUT).
- Turn on your VCR.
- Use the appropriate buttons on your remote to control the VCR. For more information about programming your HD receiver's remote control to operate your VCR, see the section "Using the Remote."

# SETUP AND CONNECTIONS

## STEP 3: PLACE BATTERIES IN THE REMOTE CONTROL

Follow these steps whenever you need to install or change the batteries in your remote control.

1. Remove the cover from the battery compartment.
2. Insert batteries into the battery compartment, matching the + and – end of each battery.
3. Replace the cover.

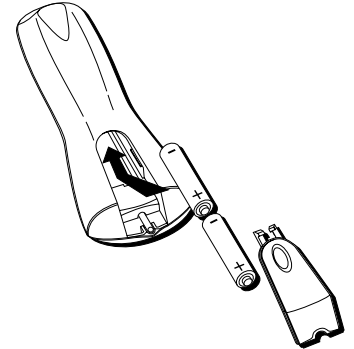

## STEP 4: PLUG IN AND TURN ON THE SYSTEM

1. Plug the power cord into a wall outlet. Be sure to insert the plugs completely.
2. To turn on the HD receiver, press the HD RCVR button on the remote control or the ON button on the front panel. When on, the button is illuminated.
3. If you are using a MultiMedia or HD monitor and have connected a VGA cable to the HD RECEIVER OUT jack, make sure the front panel button labeled HD MONITOR is illuminated.

## STEP 5: RUN INTERACTIVE SETUP

If you self-installed your satellite dish antenna, you may have already used the interactive setup to find the dish pointing coordinates, acquire and fine-tune the signal, and run a system test.

If you need to run the interactive setup again, press MENU on the remote control, select *Assistance* from the main menu, then select *Interactive Setup*. For more details, see the section "Getting Assistance" in this book.

If you just want to check your dish pointing coordinates or run the signal strength meter, select *Assistance* from the main menu, then select *Dish Pointing*.

During the interactive setup, be sure to specify the correct type of satellite dish antenna from which you are receiving DIRECTV® programming.

## STEP 6: SELECT A SCREEN FORMAT

To select a screen format:

1. Press MENU on the remote control.
2. Select *Preferences* from the main menu.
3. Then select *Screen Format*.
4. Use the arrows and OK buttons on the remote control to specify the aspect ratio of the TV or monitor you are using with your HD receiver.

If you have a 4:3 ratio monitor, you need to specify how an image with a 16:9 ratio is displayed: Letterbox or Cropped.

If you have a 16:9 ratio monitor, you need to specify how an image with a 4:3 ratio is displayed: Normal, Full, or Fill.

For more details on how the images are displayed, see the section in this book called "System Options and Preferences."

If you are using a monitor connected to the HD receiver's HD MONITOR OUT jack, there are cases where the signal cannot be received from the HD MONITOR OUT jack. You will then be given the opportunity to switch to the standard definition Audio/Video output.

# SETUP AND CONNECTIONS

## STEP 7: CONNECT THE VCR CONTROLLER

For the HD receiver to control your VCR, you need to attach the VCR Controller to the back of the HD receiver and the front of the VCR.

1. Plug the VCR Controller into the VCR CONTROL jack on the back of the HD receiver.
2. Affix the other end to the remote sensor on your VCR. (See "How to Locate the VCR's Remote Control Sensor" for details.)

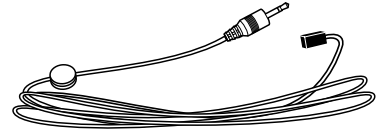

VCR Controller

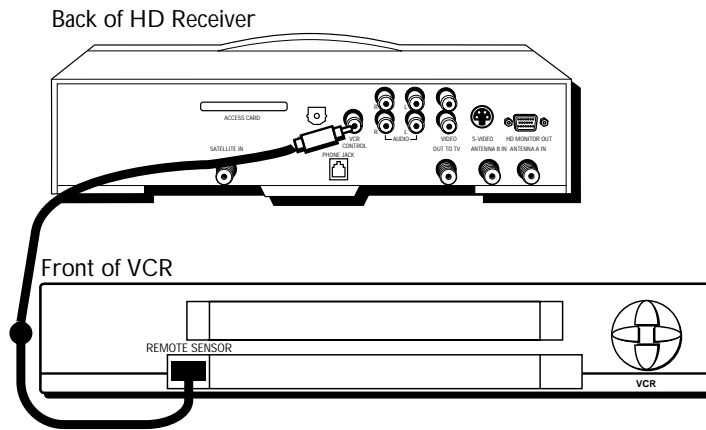

## HOW TO LOCATE THE VCR'S REMOTE CONTROL SENSOR

The VCR Controller must be affixed directly over the infrared remote sensor on your VCR.

Some VCRs have a label that identifies the infrared remote sensor, and others do not. If the IR sensor is labeled on your VCR, affix the VCR Controller directly over the sensor.

For VCRs that do not have a label for the remote sensor, you need to use the VCR's remote to locate the sensor before affixing the VCR Controller.

1. Hold the VCR's remote control so that it is touching the front of the VCR.
2. Slowly move the remote over the front of the VCR while pressing the remote power button on and off.

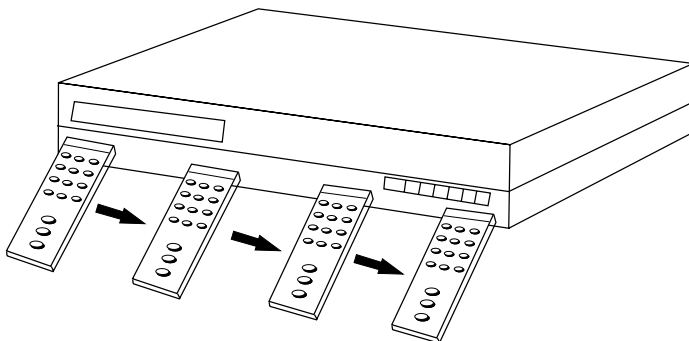

# SETUP AND CONNECTIONS

3. When your VCR turns off or on, you have located the sensor.
4. Use a piece of clear tape to temporarily attach the VCR Controller to the spot where you think the sensor is located. That way you can easily move it if you have not placed it exactly over the sensor.
5. Select a VCR type by following the steps described under "How to Select a VCR Type."

## HOW TO SELECT A VCR TYPE

After you affix the VCR Controller, you need to tell the HD receiver which VCR brand you are using.

1. Press MENU on the remote control to bring up the main menu.
2. Highlight *System Options* and press OK.
3. Highlight *Set VCR Type* and press OK.

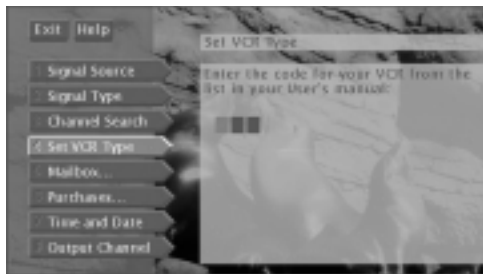

5. Use the arrows or digit buttons to input the correct three-digit code for your VCR brand. The VCR codes to use for this screen are listed on the following page.
6. Follow the on-screen instructions to ensure that you are using the correct code. If the VCR automatically stops, then you know that the HD receiver and the VCR are communicating.

Note: Some VCR brands may not be capable of being controlled by the HD receiver.

Write the three-digit code you use below in case you should need it again.

\_\_\_\_\_

# SETUP AND CONNECTIONS

## Set VCR Type Codes

Admiral .....	006, 079	JVC .....	002, 014, 016, 030, 046, 074	Samsung .....	007, 013, 022, 032, 042
Aiwa .....	015	Kenwood .....	002, 014, 016,	Sansui .....	016, 071
Akai .....	003, 017, 022, 023, 063, 066	.....	030, 044, 046	Sanyo .....	002, 012
Audio Dynamics .....	014, 016	KLH .....	073	Scott .....	004, 013, 041, 049, 068
Bell & Howell .....	002	Lloyd .....	015	Sears .....	002, 005, 009, 012,
Broksonic .....	010	Logik .....	031	.....	018, 019, 035, 043, 048
Candle .....	007, 009, 013, 044,	Magnavox .....	008, 029, 053, 056	Sharp .....	006, 024, 027, 039, 045
.....	045, 046, 052	Marantz .....	002, 008, 014, 016, 029,	Shintom .....	017, 026, 031, 055
Canon .....	008, 053	.....	030, 044, 046, 061	Signature .....	015
Capehart .....	001	Marta .....	009	Sony .....	017, 026, 038
Citizen .....	007, 009, 013, 044,	MEI .....	008	Sylvania .....	008, 015, 029, 053, 056
.....	045, 046, 052	Memorex .....	008, 009, 012, 015	Symphonic .....	015
Colortyme .....	014	MGA .....	004, 027	Tandy .....	002, 015
Craig .....	007, 012	Midland .....	032	Tashiko .....	009
Curtis Mathes .....	000, 007, 008, 014,	Minolta .....	005, 035	Tatung .....	030
.....	015, 044, 046, 053, 064, 067	Mitsubishi .....	004, 005, 027, 035, 040	Teac .....	015, 030, 069
Daewoo .....	013, 045, 052, 076	Montgomery Ward .....	006	Technics .....	008
dbx .....	014, 016	MTC .....	007, 015	Teknika .....	008, 009, 015, 021
Dimensia .....	000	Multitech .....	007, 015, 031, 032	Toshiba .....	005, 013, 019, 048, 049
Dynatech .....	015	NEC .....	002, 014, 016, 030, 044,	Totevision .....	007, 009
Electrohome .....	027	.....	046, 059, 061, 064	TMK .....	067
Emerson .....	008, 009, 010, 013, 015,	Panasonic .....	008, 053, 075, 077	Unitech .....	007
020, 023, 027, 034, 041, 042, 047, 049,	.....	Pentax .....	005, 035, 044	Vector Research .....	014, 016, 044
.....	057, 062, 065, 067, 068, 070	Pentex Research + .....	46	Victor .....	016
Fisher .....	002, 012, 018, 019,	Philco .....	008, 029, 053, 056	Video Concepts .....	014, 016, 044
.....	043, 048, 058	Philips .....	008, 029	Videosonic .....	007
Funai .....	015	Pioneer .....	005, 016, 050	Wards ....	005, 006, 007, 008, 009, 012,
GE .....	000, 007, 008, 032, 037, 053	Portland .....	044, 045, 052	.....	013, 015, 025, 027, 031, 035
Goldstar .....	009, 014, 046, 060	PROSCAN .....	000	Yamaha .....	002, 014, 016, 030, 046
Harman Kardon .....	014	Quartz .....	002	Zenith .....	011, 017, 026, 072, 079
Hitachi .....	005, 015, 035, 036	Quasar .....	008, 053		
Instant Replay .....	008	Radio Shack/Realistic ....	002, 006, 008,		
JCL .....	008	.....	009, 012, 015, 019, 027, 043, 053		
JC Penney .....	002, 005, 007, 008, 014,	RCA .....	000, 005, 007, 008, 028, 035,		
.....	016, 030, 035, 051, 053	.....	037, 054, 069		

## STEP 8: ORDER PROGRAMMING

You should decide if you would like to receive DIRECTV® programming\*. To receive DIRECTV programming, your satellite dish antenna must be installed and pointed correctly. You must also contact DIRECTV.

Programming with DIRECTV: Call 1-800-347-3288

\* DIRECTV® programming is provided in accordance with the terms and conditions of the DIRECTV Customer Agreement, a copy of which is provided with your first DIRECTV billing statement. DIRECTV is a trademark of DIRECTV, Inc., a unit of Hughes Electronics Corp., and is used with permission.

When you order programming, you need to know your access card number. To get the number, press MENU on the remote control, then select *Assistance* from the main menu and then select *System Test*.

Wait for the system to run all of its tests. The access card number is displayed at the end of the system test.

Write the access card number in the space below for easy reference:

\_\_\_\_\_

# USING THE REMOTE

## HOW TO USE YOUR UNIVERSAL REMOTE

In this section, you will find out how to use your universal remote control. This section:

- defines the buttons on the remote control
- describes how you toggle between TV viewing and DIRECTV viewing using the HD receiver
- shows you how to change between analog, digital, and DIRECTV channels
- describes how to program the remote to control other devices, such as a VCR

Because this universal remote can control several different components (HD receiver, VCR, etc.), it uses operational modes triggered by the component buttons. For example, if you want the remote to control the VCR, you would press the VCR button to put the remote into VCR mode so you could control the VCR.

### 1 SETUP AND CONNECTIONS



### 2 USING THE REMOTE



### 3 BASIC OPERATION



### 4 USING THE PROGRAM GUIDES



### 5 AUDIO CONTROLS AND TIMERS



### 6 USING THE PROFILES



### 7 SYSTEM OPTIONS AND PREFERENCES



### 8 GETTING ASSISTANCE



### 9 REFERENCE

# USING THE REMOTE

## REMOTE CONTROL BUTTONS

**ON•OFF** Turns the HD receiver on or off. If the remote is in another component mode, (VCR, DVD, etc.) and programmed, ON•OFF will turn the component on and off. When pressed twice within two seconds, all components that are on will be turned off (this feature only works with most RCA, PROSCAN, and GE products).

**VCR1** When programmed, tells the remote to control VCR1.

**TV** When programmed, tells the remote to control the TV monitor.

**DVD** Tells the remote to control an RCA, GE, or PROSCAN DVD player.

**VCR2** When programmed, tells the remote to control VCR2.

**LED** Light that indicates you're in programming mode when programming the remote control. Also displays when a valid remote control button is pressed.

**AUX** When programmed, tells the remote to control the component (such as a laserdisc player) that you have specified. Acts as a "wildcard" device button; it can be programmed to control another VCR, TV, or cable box. Or, it can be programmed to control an RCA, GE, or PROSCAN audio component.

**HD RCVR** Turns on the HD receiver and tells the remote to control the HD receiver.

**MUTE** When programmed, reduces the TV's volume to its minimum level. Press again to restore volume.

**WHO** Toggles through the HD receiver's user profiles. Press again to see the next available profile.

**CHAN + / -** Scroll up or down through the current channel list. Press once to change the channel up or down; press and hold to continue changing channels. If you are viewing TV programs and press CH +/-, you scroll through TV channels. If you subscribe to DIRECTV® programming and are viewing DIRECTV programs, you scroll through DIRECTV channels.

**VOL < / >** When programmed, adjusts the TV's audio volume.

**FETCH** Brings up the Fetch menu, which is a list of commonly accessed menu items.

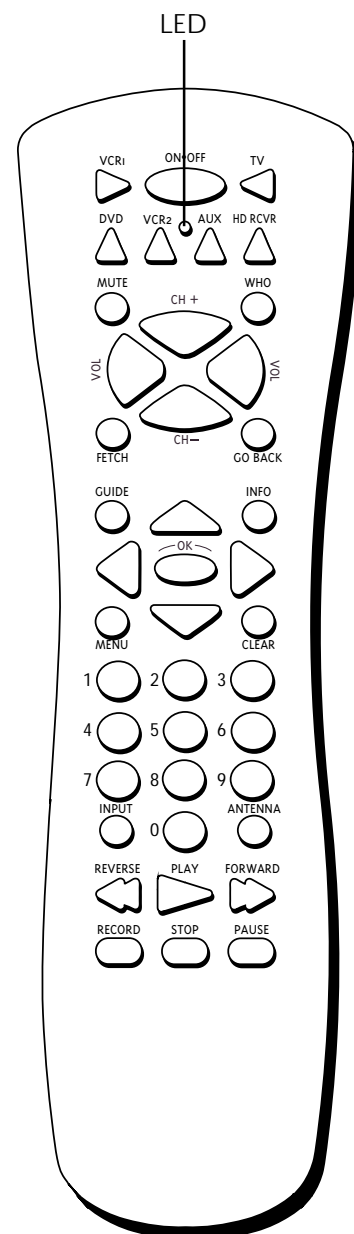



# USING THE REMOTE

**GO BACK** Moves you back and forth between the last two channels selected during either DIRECTV or TV viewing. For example, if you have been viewing both DIRECTV and TV channels, pressing GO BACK while watching a DIRECTV channel moves you back to the last DIRECTV channel you viewed. Pressing it while watching a TV channel moves you to the last TV channel you viewed. In the menu system, pressing GO BACK returns you to the previous menu screen.

**GUIDE** While viewing TV broadcasts, brings up the TV program guide. While viewing DIRECTV broadcasts, brings up the DIRECTV® programming guide. Subsequent presses of the GUIDE button toggle through the different types of guides.

**INFO** Brings up channel and viewing information via the channel banner. Quickly press again to bring up an extended channel banner and a third time to remove the banner. Press when in the program guides to get more information on the highlighted program or channel.

**ARROWS** Use to highlight different items in the menu system and adjust the menu controls.

**OK** When in the menu system and other on-screen displays, selects highlighted items.

**MENU** Brings up the main menu and selects highlighted items. When using an RCA, GE or PROSCAN VCR and in VCR mode, it functions as a PROGRAM button.

**CLEAR** Removes on screen displays and returns to normal viewing.

**DIGIT BUTTONS (0 - 9)** Enter channel numbers directly through the remote control. For more information on entering digits to change channels, see the section "Basic Operation." When in the menus, the digit buttons can be used to directly select items without using the arrows. 0 can be used to return to the previous menu screen.

**INPUT** Toggles between the HD receiver's TV and DIRECTV program viewing.

**ANTENNA** Switches the source of the TV input signal between the HD receiver's ANTENNA A and B. When programmed and in VCR mode, the ANTENNA button functions as a TV/VCR button.

**REVERSE, PLAY, FORWARD, RECORD, STOP, PAUSE** If programmed, provides transport control for some remote-controllable VCRs, DVD players, laserdisc players, tape decks, and CD players.

Don't worry about getting stuck inside a menu. Pressing the CLEAR button on the remote control takes you out of the menu system and back to the program you were watching.

# USING THE REMOTE

## PROGRAMMING THE REMOTE CONTROL

The universal remote can be programmed to control most brands of remote controllable components, such as VCRs. The remote is already programmed to control most RCA, GE and PROSCAN TVs, VCRs, DVD players, and laserdisc players.

## TESTING THE REMOTE CONTROL

To determine whether the universal remote control requires programming, turn on a component, such as a VCR, point the remote control at the VCR, and press the VCR1 button. Then press ON•OFF or CH ^ (channel up) or CH v (channel down) to see if the VCR responds to the remote control commands. If not, it requires programming.

## PROGRAMMING THE REMOTE CONTROL

### Using Automatic Code Search

The following instructions can be used to program the remote control. If you want to exit the automatic code search without programming any of your components, press and hold CLEAR until the LED light on the remote control turns off.

1. Turn on the component you want to control (VCR, etc.).
2. Press and hold the button you want to program (VCR1, VCR2, TV, etc.). Note that the AUX button can only be programmed using direct entry (see the next section for details on direct entry). While holding the component button, press and hold ON•OFF until the LED light on the remote control turns on, then release both buttons.
3. Point the remote at the component and press and release PLAY. Then wait five seconds or until the LED light stops flashing.

At this point the remote control is searching for the correct code to program. If, after five seconds, the component you want to control does not turn off, press PLAY again to tell the remote control to search the next set of codes.

Continue pressing PLAY until the component turns off or you have searched through all of the codes. There are 20 total sets of codes. If the component does not turn off after pressing PLAY 20 times, then the remote cannot control that particular component.

If the component you want to control *does* turn off:

1. Press and release REVERSE, then wait two seconds. Repeat this step until the component turns back on.
2. To finish, press and hold STOP until the LED light on the remote control turns off.

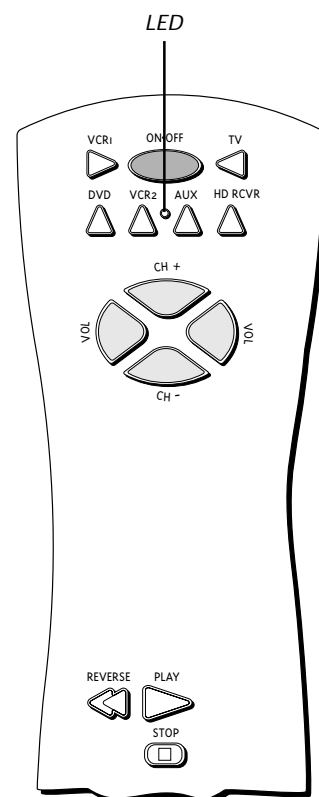

*You'll use these buttons when you program the remote to control any component.*

*The remote may not operate all models of all brands.*

# USING THE REMOTE

## Using Direct Entry

1. Turn on the component to be programmed.
2. Look up the brand and code number(s) for the component on the code list in this section "Remote Control Codes."
3. Press and hold the remote control button you want to program.
4. Enter the code from the code list.
5. Release the button, and then press ON•OFF to see if the component responds to the remote control commands. If it doesn't, try pressing the component button and then ON•OFF again.
6. If you get no response, repeat these steps using the next code listed for your brand until the component responds to the remote control commands.

This remote control may not operate all models of the brands that are shown. Use the codes shown on this page and the next, or on the sheet packed with your remote control.

## USING THE REMOTE TO CONTROL A COMPONENT

Once the remote has been programmed successfully, you are ready to use it to control your components, such as a VCR, TV, or laserdisc player.

To operate the component:

1. Press the component button (VCR1, VCR2, TV, or AUX) to set the remote to control the component.
2. Press ON•OFF to turn the component on or off.
3. Use the remote control buttons that apply to that component.

## REMOTE CONTROL CODES

Cable Boxes	
ABC	5002, 5003, 5004, 5005, 5006, 5007, 5053
Antronix	5008, 5009
Archer	5008, 5009, 5010, 5011
Cabletenna	5008
Cableview	5008
Century	5011
Citizen	5011
Colour Voice	5012, 5013
Comtronics	5014, 5015
Contec	5016
Jasco	5011
Jerrold	5003, 5005, 5007, 5018, 5023, 5024, 5046, 5053
Magnavox	5025
Memorex	5026
Movie Time	5002, 5027, 5028
NSC	5002, 5027, 5028
Oak	5002, 5016, 5029
Panasonic	5048, 5052
Paragon	5026
Philips	5011, 5012, 5013, 5019, 5025, 5030, 5031, 5032
Pioneer	5033, 5034
Pulsar	5026
RCA	5047, 5049, 5052
Realistic	5009, 5049
Regal	5022, 5035
Regency	5017
Rembrandt	5003
Runco	5026
Samsung	5014, 5034
Scientific Atlanta	5006, 5036, 5037, 5038
Signal	5014, 5018
Signature	5003
SL Marx	5014
Sprucer	5052
Starcom	5007, 5018, 5053
Stargate	5014, 5018
Starquest	5018
Tandy	5040

Television	5014
Tocom	5004, 5023, 5041
Toshiba	5026
Tusa	5018
TV86	5027
Unika	5008, 5009, 5011
United Artists	5002
United Cable	5053
Universal	5008, 5009, 5010, 5011
Viewaway	5044
Viewstar	5015, 5025, 5027, 5040
Zenith	5026, 5050, 5051

Satellite Receivers	
Chapparral	5056, 5057
Drake	5058, 5059
GE	5000, 5001
General Instruments	5060, 5061, 5062
Panasonic	5075
Primostar	5076
PROSCAN	5000, 5001
RCA	5000, 5001
Realistic	5063
Sony	5072
STS1	5064
STS2	5065
STS3	5066
STS4	5067
Toshiba	5068
Toshiba	5073

Audio	
(For RCA and Dimensia brands only)	
AM/FM	4003
Aux	4004
Phono	4005
CD	4007
Tape	4006

VCR	
Admiral	2131
Adventura	2026
Aiko	2027
Aiwa	2002, 2026
Akai	2003, 2004, 2005, 2007, 2008, 2111, 2112, 2113
American High	2021
Asha	2013
Audio Dynamics	2009, 2010
Audiovox	2014
Bell & Howell	2011
Beaumarck	2013
Broksonic	2012, 2025
Calix	2014
Candle	2013, 2014, 2015, 2016, 2017, 2018, 2019
Canon	2021, 2022, 2114
Capehart	2020, 2110
Carver	2062
CCE	2027, 2061
Citizen	2013, 2014, 2015, 2016, 2017, 2018, 2019, 2027
Colortyme	2009
Colt	2061
Craig	2013, 2014, 2023, 2061
Curtis-Mathes	2000, 2002, 2009, 2013, 2016, 2018, 2021, 2022, 2024, 2115
Cybernex	2013
Daewoo	2015, 2017, 2019, 2025, 2026, 2027, 2028, 2110
Daytron	2110
Dbx	2009, 2010
Dimensia	2000
Dynatech	2002, 2026
Electrohome	2014, 2029
Electrohome	2014
Emerson	2002, 2012, 2014, 2015, 2021, 2024, 2025, 2026, 2029, 2030, 2032, 2033, 2034, 2035, 2036, 2037, 2038, 2039, 2040, 2041, 2042, 2044, 2045, 2047, 2065, 2105, 2113, 2116, 2117, 2130
Fisher	2011, 2023, 2048, 2049, 2050, 2051, 2052, 2118
Fuji	2021, 2119
Funai	2002, 2026

# USING THE REMOTE

Garrard ..... 2026  
 GE ..... 2000, 2001, 2013, 2021, 2022, 2053, 2115, 2120  
 Goldstar ..... 2009, 2014, 2018, 2054, 2121  
 Gradiente ..... 2026  
 Harley Davidson ..... 2026  
 Harman Kardon ..... 2009  
 Harwood ..... 2061  
 Headquarter ..... 2011  
 Hitachi ..... 2002, 2055, 2056, 2057, 2107, 2111, 2120, 2122  
 HI-Q ..... 2023  
 Instant Replay ..... 2021  
 JCL ..... 2021  
 JC Penney ..... 2009, 2010, 2011, 2013, 2014, 2021, 2022, 2055, 2056, 2058, 2059, 2060, 2107, 2118  
 Jensen ..... 2055, 2056, 2111  
 JVC ..... 2009, 2010, 2011, 2018, 2058, 2111, 2123  
 Kenwood ..... 2009, 2010, 2011, 2016, 2018, 2058, 2111, 2123  
 KLH ..... 2061  
 Kodak ..... 2014, 2021  
 Lloyd ..... 2002, 2026  
 Logik ..... 2061  
 LXI ..... 2014  
 Magnavox ..... 2021, 2022, 2062, 2063, 2104, 2108, 2124  
 Magnin ..... 2013  
 Marantz ..... 2009, 2010, 2011, 2016, 2018, 2021, 2058, 2062, 2064  
 Marta ..... 2014  
 Masushita ..... 2021  
 MEI ..... 2021  
 Memorex ..... 2002, 2011, 2013, 2014, 2021, 2023, 2026, 2104, 2131  
 MGA ..... 2029, 2065, 2113  
 MGN Technology ..... 2013  
 Midland ..... 2053  
 Minolta ..... 2055, 2056, 2107  
 Mitsubishi ..... 2029, 2055, 2056, 2065, 2066, 2067, 2069, 2070, 2071, 2072, 2073, 2074, 2106, 2113, 2123  
 Montgomery Ward ..... 2075, 2131  
 Motorola ..... 2021, 2131  
 MTC ..... 2002, 2013, 2026  
 Multitech ..... 2002, 2013, 2016, 2026, 2053, 2061  
 NEC ..... 2009, 2010, 2011, 2016, 2018, 2058, 2064, 2076, 2078, 2079, 2111, 2123  
 Nikko ..... 2014  
 Noblex ..... 2013  
 Olympus ..... 2021  
 Optimus ..... 2014, 2131  
 Optonica ..... 2096  
 Orion ..... 2035  
 Panasonic ..... 2021, 2022, 2109, 2125, 2126, 2127  
 Pentax ..... 2016, 2055, 2056, 2107, 2120  
 Pentax Research ..... 2018  
 Philco ..... 2021, 2022, 2062, 2063  
 Philips ..... 2021, 2062, 2096, 2124  
 Pilot ..... 2014  
 Pioneer ..... 2010, 2055, 2080, 2081, 2123  
 Portland ..... 2016, 2017, 2019, 2110  
 ProSCAN ..... 2000, 2001  
 Protec ..... 2061  
 Pulsar ..... 2104  
 Quarter ..... 2011  
 Quartz ..... 2011  
 Quasar ..... 2021, 2022, 2125  
 RCA ..... 2000, 2001, 2003, 2013, 2021, 2055, 2056, 2082, 2083, 2084, 2085, 2086, 2087, 2088, 2089, 2090, 2091, 2107, 2115, 2120, 2125  
 Radioshack/Realistic ..... 2002, 2011, 2013, 2014, 2021, 2022, 2023, 2026, 2029, 2049, 2050, 2096, 2131  
 Radix ..... 2014  
 Randex ..... 2014  
 Ricoh ..... 2128  
 Runco ..... 2104  
 Samsung ..... 2005, 2013, 2015, 2033, 2053, 2112  
 Sanky ..... 2131, 2104  
 Sansui ..... 2010, 2092, 2111, 2123  
 Sanyo ..... 2011, 2013, 2023  
 Scott ..... 2012, 2015, 2025, 2032, 2035, 2038, 2065, 2093, 2116  
 Sears ..... 2011, 2014, 2021, 2023, 2048, 2049, 2050, 2051, 2055, 2056, 2107, 2118  
 Sharp ..... 2002, 2017, 2029, 2094, 2095, 2096, 2131  
 Shintom ..... 2004, 2056, 2061, 2098  
 Shogun ..... 2013  
 Signature ..... 2002, 2131  
 Singer ..... 2021, 2061, 2128  
 Sony ..... 2002, 2004, 2098, 2099, 2119, 2128  
 STS ..... 2021, 2107  
 Sylvania ..... 2002, 2021, 2022, 2026, 2062, 2063, 2065, 2124  
 Symphonic ..... 2002, 2026  
 Tandy ..... 2002, 2011  
 Tashiko ..... 2014  
 Tatung ..... 2058, 2111  
 TEAC ..... 2002, 2026, 2058, 2085, 2111  
 Technics ..... 2021, 2109  
 Teknika ..... 2002, 2014, 2021, 2026, 2100, 2129  
 TMK ..... 2013, 2024, 2047

Toshiba ..... 2015, 2049, 2051, 2055, 2065, 2093, 2116  
 ToteVision ..... 2013, 2014  
 Unitech ..... 2013  
 Vector Research ..... 2009, 2010, 2015, 2016  
 Victor ..... 2010  
 Video Concepts ..... 2009, 2010, 2015, 2016, 2113  
 Videosonic ..... 2013  
 Wards ..... 2002, 2013, 2014, 2015, 2021, 2023, 2026, 2029, 2055, 2056, 2061, 2096, 2101, 2102, 2103, 2107, 2118, 2131  
 XR-1000 ..... 2021, 2026, 2061  
 Yamaha ..... 2009, 2010, 2011, 2018, 2058, 2111  
 Zenith ..... 2004, 2098, 2104, 2119, 2128

## TV

Abex ..... 1172  
 Admiral ..... 1001, 1173  
 Adventura ..... 1174  
 Aiko ..... 1016  
 Akai ..... 1002  
 Alleron ..... 1046  
 Amtron ..... 1038  
 Anam National ..... 1003, 1038  
 AOC ..... 1004, 1005, 1006, 1007, 1175, 1176  
 Audiovox ..... 1038  
 Belcor ..... 1004  
 Bell & Howell ..... 1001, 1083, 1162  
 Bradford ..... 1038  
 Brokwood ..... 1004  
 Candle ..... 1004, 1006, 1008, 1174  
 Capehart ..... 1175  
 Celebrity ..... 1002  
 Centurion ..... 1009  
 Citizen ..... 1004, 1006, 1008, 1016, 1038, 1105, 1171, 1174, 1177  
 Clairtone ..... 1176  
 Colortyme ..... 1004, 1006  
 Concerto ..... 1004, 1006  
 Contec/Cony ..... 1012, 1013, 1014, 1038, 1176  
 Craig ..... 1038  
 Crown ..... 1038, 1171  
 Curtis Mathes .. 1000, 1004, 1006, 1015, 1105, 1162, 1171  
 CXC ..... 1038  
 Daewoo .. 1004, 1005, 1006, 1016, 1017, 1018, 1127, 1171  
 Dayton ..... 1004, 1006, 1171  
 Dimensia ..... 1000  
 Dumont ..... 1004, 1151  
 Dynatech ..... 1178  
 Electroband ..... 1002, 1176  
 Electrohome ..... 1003, 1004, 1006, 1019, 1022  
 Emerson 1004, 1006, 1012, 1014, 1023, 1024, 1025, 1026, 1027, 1028, 1029, 1030, 1031, 1032, 1033, 1034, 1035, 1036, 1037, 1038, 1039, 1041, 1042, 1043, 1044, 1046, 1047, 1123, 1124, 1162, 1171, 1176, 1177, 1179, 1191  
 Envision ..... 1004, 1006  
 Fisher ..... 1048, 1049, 1050, 1051, 1162, 1180  
 Fujitsu ..... 1046  
 Funai ..... 1038, 1046  
 Futuretec ..... 1038  
 GE ..... 1000, 1003, 1004, 1006, 1022, 1052, 1054, 1055, 1087, 1164, 1165, 1166, 1167, 1168, 1181  
 Gibraltar ..... 1004, 1151  
 Goldstar ..... 1004, 1005, 1006, 1012, 1019  
 ..... 1056, 1057, 1058, 1155, 1156, 1171, 1172  
 Grundy ..... 1038, 1046, 1171  
 Hallmark ..... 1004, 1006  
 Harvard ..... 1038  
 Hitachi ..... 1004, 1006, 1012, 1013, 1059, 1060, 1061, 1135, 1136, 1137, 1138, 1139, 1140, 1141, 1142, 1143, 1144, 1145, 1146, 1148, 1150, 1179  
 IMA ..... 1038  
 Infinity ..... 1062  
 Janeli ..... 1174  
 JBL ..... 1062  
 JCB ..... 1002  
 JC Penny 1000, 1004, 1005, 1006, 1008, 1022, 1052, 1054, 1058, 1063, 1064, 1072, 1087, 1105, 1128, 1171, 1172, 1181  
 Jensen ..... 1004, 1006  
 JVC ..... 1012, 1013, 1054, 1060, 1065, 1066, 1067, 1089, 1157, 1158, 1159, 1182  
 Kawasho ..... 1002, 1004, 1006  
 Kaypani ..... 1175  
 Kenwood ..... 1004, 1006, 1019  
 Kloss Novabeam ..... 1068, 1069, 1174, 1183  
 KTV ..... 1038, 1070, 1171, 1176, 1177  
 Loewe ..... 1062  
 Logik ..... 1083  
 Luxman ..... 1004, 1006  
 LXI 1000, 1006, 1049, 1062, 1071, 1072, 1073, 1162, 1181  
 Magnavox ..... 1004, 1006, 1008, 1019, 1062, 1068, 1069, 1074, 1075, 1076, 1077, 1088, 1089, 1131, 1130, 1132, 1133, 1134, 1183, 1184  
 Majestic ..... 1083

Marantz ..... 1062  
 Marantz ..... 1004, 1006, 1062, 1078  
 Megatron ..... 1006, 1059  
 MEI ..... 1176  
 Memorex ..... 1001, 1006, 1082, 1083, 1162  
 MGA 1004, 1005, 1006, 1019, 1022, 1051, 1079, 1080, 1082  
 Midland ..... 1054, 1151, 1171, 1172, 1181  
 Minutz ..... 1052  
 Mitsubishi ..... 1004, 1005, 1006, 1019, 1022, 1051, 1079, 1080, 1081, 1082, 1083, 1125  
 Montgomery Ward ..... 1083  
 Motorola ..... 1003, 1173  
 MTC ..... 1004, 1005, 1006, 1105, 1176, 1178  
 Multitech ..... 1038, 1178  
 Multivision ..... 1084  
 NAD ..... 1006, 1071, 1072, 1185  
 NEC ..... 1003, 1004, 1005, 1006, 1089  
 Nikko ..... 1006, 1016  
 NTC ..... 1016  
 Onwa ..... 1038  
 Optimus ..... 1185  
 Optonica ..... 1095, 1173  
 Orion ..... 1035, 1191  
 Panasonic ..... 1003, 1054, 1062, 1170  
 Philco ... 1003, 1004, 1005, 1006, 1008, 1012, 1019, 1062, 1068, 1069, 1074, 1075, 1077, 1183, 1184  
 Philips .. 1003, 1004, 1008, 1012, 1019, 1062, 1068, 1069, 1074, 1075, 1076, 1086, 1087, 1088, 1089  
 Pilot ..... 1004, 1171  
 Pioneer ..... 1004, 1006, 1090, 1091, 1092, 1179, 1185  
 Portland ..... 1004, 1005, 1006, 1016, 1171  
 Price Club ..... 1105  
 Prism ..... 1054  
 PROSCAN ..... 1000, 1181  
 Proton ..... 1004, 1006, 1012, 1093, 1175  
 Pulsar ..... 1151  
 Pulsar ..... 1004  
 Quasar ..... 1003, 1054, 1070, 1094  
 Radio Shack/Realistic ..... 1000, 1004, 1006, 1012, 1038, 1049, 1095, 1162, 1171, 1172  
 RCA ..... 1000, 1003, 1004, 1005, 1006, 1007, 1019, 1096, 1098, 1099, 1100, 1101, 1102, 1103, 1129, 1179, 1181, 1187, 1188, 1190, 1198, 1199  
 Rhapsody ..... 1176  
 Runco ..... 1151  
 Sampo ..... 1004, 1006, 1171, 1172, 1175  
 Samsung ..... 1004, 1005, 1006, 1012, 1015  
 ..... 1019, 1104, 1105, 1106, 1171, 1172  
 Samsux ..... 1171  
 Sansui ..... 1191  
 Sanyo ..... 1004, 1048, 1049, 1050, 1080, 1107, 1108, 1162, 1180, 1189  
 Scotch ..... 1006  
 Scott ..... 1004, 1006, 1012, 1024, 1035, 1038, 1046  
 Sears ... 1000, 1004, 1006, 1013, 1019, 1046, 1048, 1049, 1050, 1051, 1066, 1071, 1072, 1109, 1110, 1162, 1180, 1181, 1189  
 Sharp ..... 1004, 1006, 1012, 1029, 1095, 1111, 1112, 1113, 1122, 1171, 1173  
 Shogun ..... 1004  
 Signature ..... 1001, 1083, 1115  
 Simpson ..... 1008  
 Sonic ..... 1176  
 Sony ..... 1002  
 Soundesign ..... 1004, 1006, 1008, 1038, 1046  
 Squareview ..... 1189  
 SSS ..... 1004, 1038  
 Starlite ..... 1038  
 Supre-macy ..... 1174  
 Supreme ..... 1002  
 Sylvania ..... 1004, 1006, 1008, 1019, 1062, 1068, 1069, 1074, 1075, 1076, 1077, 1088, 1116, 1161, 1183, 1184  
 Symphonic ..... 1033, 1038, 1189  
 Tandy ..... 1173  
 Tatung ..... 1003, 1178  
 Technics ..... 1054  
 Techwood ..... 1004, 1006, 1054  
 Teknika ..... 1004, 1005, 1006, 1008, 1012, 1013, 1016, 1038, 1046, 1076, 1082, 1083, 1105, 1170, 1171  
 Telecaption ..... 1117  
 TMK ..... 1004, 1006  
 Toshiba ..... 1105, 1109, 1049, 1071, 1072, 1089, 1117, 1118, 1160, 1162  
 Totevision ..... 1171  
 Universal ..... 1052, 1087  
 Victor ..... 1066, 1182  
 Vidtech ..... 1004, 1005, 1006  
 Viking ..... 1174  
 Wards ..... 1000, 1001, 1004, 1005, 1006, 1019, 1024, 1033, 1046, 1052, 1062, 1068, 1069, 1074, 1075, 1076, 1083, 1087, 1088, 1095, 1119, 1120, 1184  
 Yamaha ..... 1004, 1005, 1006, 1019  
 Zenith ..... 1004, 1083, 1151, 1152, 1153, 1154

# BASIC OPERATION

## HOW TO USE YOUR HD RECEIVER

This section tells you about the interactive channel banner, which appears when you change channels or press INFO on the remote.

It also describes how to change channels.

This section gives you a broad, clear view of how to operate the basics of your HD receiver.

**1** SETUP AND CONNECTIONS



**2** USING THE REMOTE



**3** BASIC OPERATION



**4** USING THE PROGRAM GUIDES



**5** AUDIO CONTROLS AND TIMERS



**6** USING THE PROFILES



**7** SYSTEM OPTIONS AND PREFERENCES



**8** GETTING ASSISTANCE



**9** REFERENCE

# BASIC OPERATION

## ABOUT THE CHANNEL BANNER

The channel banner appears whenever you tune to a channel or press INFO on the remote control. When the banner is displayed, pressing INFO gives extended information. You can also use the arrow buttons and OK to choose an item in the channel banner.

Channel banner icons represent frequently-used features. Some icons change appearance to show the item's status or availability. Below is a description of the icons you'll find on the channel banner.

Press **INFO** on the remote control twice to view an expanded channel banner that shows a program description (when available).

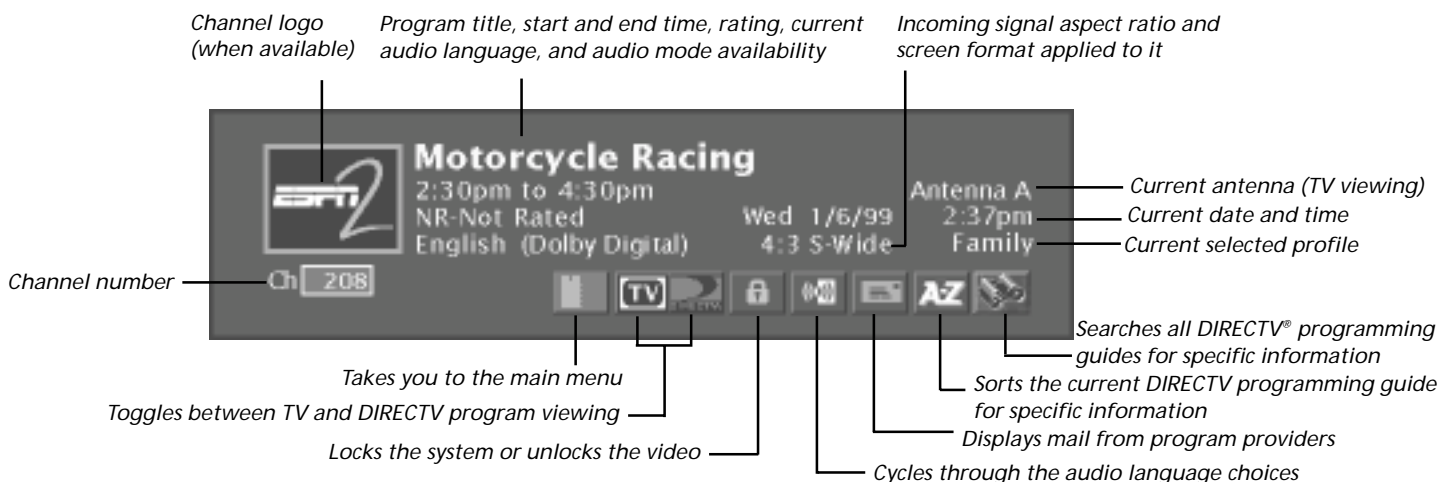

**Main menu icon** When selected, takes you to the main menu.

**TV/DIRECTV logo** When selected, toggles between TV and DIRECTV viewing. The highlighted icon indicates the current viewing state.

**Green unlock icon** Indicates that the system is unlocked. Spending, viewing and other limits can be accessed and changed. When selected, locks the system.

**Yellow unlock icon** Indicates that a password has been entered to override profile limits. No limits can be accessed or changed. When selected, locks the system.

**Red lock icon** Indicates that no limits can be accessed or changed. A password is required to override limits or access the system.

**Audio language icon** If the icon is highlighted while watching a digital (ATSC) or DIRECTV channel, two or more audio languages are available. Selecting the icon repeatedly scrolls through and plays the options.

If the icon is highlighted when watching an analog (NTSC) TV channel, a Second Audio Program (SAP) is available. Selecting the icon will play the SAP for the current channel until the channel is changed.

**Highlighted mail icon** Indicates that you have a message in your mailbox from your DIRECTV® programming provider. Select this icon to access the mailbox and read your mail.

**AlphaSort™ (A-Z) icon** When selected, allows you to sort currently-listed program titles alphabetically.

**Highlighted Scout™ (binoculars) icon** When highlighted, indicates a Scout has found a program. If selected when highlighted, you view the Scout's results. If you select the icon when it is not highlighted, you can set up a Scout to find a program for you.

Please note that when you're viewing TV broadcasts, the channel banner will not look the same as when you're viewing DIRECTV broadcasts.

# BASIC OPERATION

## CHANGING BETWEEN DIRECTV AND TV VIEWING

When you change channels, you tune to programming that can come from either TV inputs (Antenna A or B) or from the satellite input (if you subscribe to DIRECTV® programming). You can select one of these sources by pressing INPUT on the remote control to choose whether you want to view TV or DIRECTV programming. Then you can enter the channel numbers.

### When viewing DIRECTV® programming:

You tune to channels that come from DIRECTV (if you subscribe to DIRECTV® programming). Press INPUT until the DIRECTV icon is highlighted in the channel banner. Enter channel numbers that are three or four digits long. If the channel is three digits, you will need to press OK to tune.

### When viewing TV programming:

You tune to channels that carry the terrestrial off-air or cable TV signal. Press INPUT until the TV icon is highlighted in the channel banner. Then:

- To tune to an analog channel, enter channel numbers that are up to three digits long. Press OK to tune. Since analog channels don't have subchannels, you don't need to enter a subchannel number.
- To tune to a digital channel, enter channel numbers that are one, two, or three digits long. If necessary, press the right arrow and enter a subchannel number. These numbers appear in the box to the right of the primary channel number. Press OK to tune.

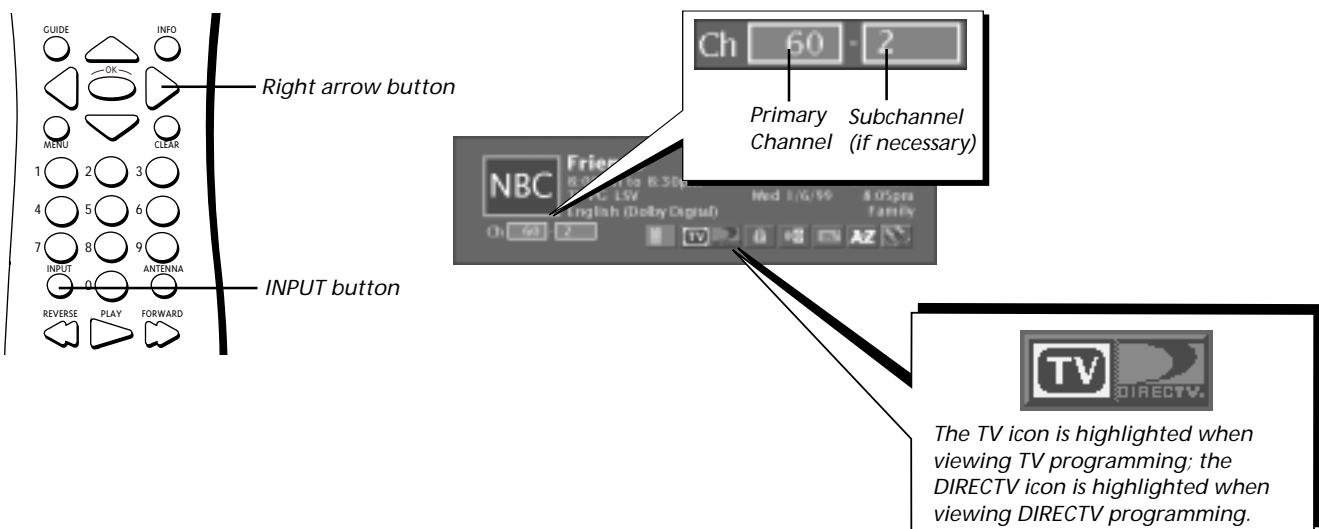

# BASIC OPERATION

## CHANGING CHANNELS

To change channels by entering numbers with the remote control, you need to tell the HD receiver what you want to view: DIRECTV® programming (if you subscribe to DIRECTV) or TV programs.

### When you want to watch a DIRECTV channel:

1. Press INPUT on the remote control until the DIRECTV icon is highlighted in the channel banner.
2. Enter the channel number and press OK. The channel numbers are three or four digits long. Note that it may not be necessary to press OK after you enter a four-digit channel number.

If you do not enter at least three digits, "???" will appear in the channel entry box, and the system will wait for a valid entry.

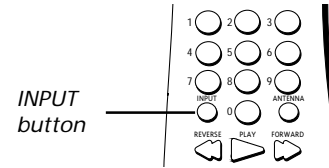

Channel entry box

Highlighted to indicate you are viewing DIRECTV® programming

### When you want to watch a digital or analog TV channel:

If you want to watch an analog channel:

1. Press INPUT on the remote control until the TV icon is highlighted in the channel banner.
2. Enter the channel number. This number will appear in the primary channel entry box. (Analog channels don't have subchannels.)
3. Press OK on the remote control to tune to the channel.

If you want to watch a digital channel:

1. Press INPUT on the remote control until the TV icon is highlighted in the channel banner.
2. Enter the primary channel number. This number will appear in the primary channel entry box. If there is no subchannel, press OK.
3. If the primary channel number has fewer than three digits and you want to enter subchannel numbers, press the right arrow to advance to the subchannel entry box.
4. Enter the number of the subchannel. This number will appear in the subchannel entry box.
5. Press OK on the remote control to tune to the programming.

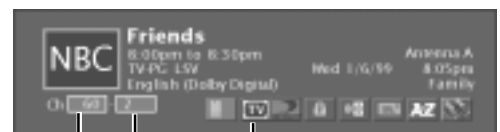
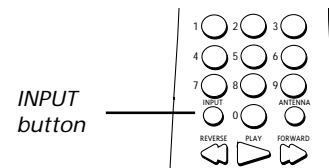

Primary channel entry box

Subchannel entry box

Highlighted to indicate you are viewing TV programming

Note that you can always use the channel up and down buttons on the remote control to change channels within DIRECTV and TV channel viewing.



# USING THE PROGRAM GUIDES

## WHAT IS A PROGRAM GUIDE?

A program guide is an on-screen programming schedule. It is a list of the current and future programs. There are separate guides for TV programs and DIRECTV programs (available if you subscribe to DIRECTV® programming).

Both of these guides can be viewed in different formats.

Using the program guides is easy as long as you remember to highlight items on the screen by pressing the arrow buttons on the remote control. Then, press OK to tune to that channel.

**1** SETUP AND CONNECTIONS



**2** USING THE REMOTE



**3** BASIC OPERATION



**4** USING THE PROGRAM GUIDES



**5** AUDIO CONTROLS AND TIMERS



**6** USING THE PROFILES



**7** SYSTEM OPTIONS AND PREFERENCES



**8** GETTING ASSISTANCE



**9** REFERENCE

# USING THE PROGRAM GUIDES

## BRINGING UP THE PROGRAM GUIDES

If you subscribe to DIRECTV® programming, you have access to two program guides: a DIRECTV guide and a TV program guide (for terrestrial programming). If you do not subscribe to DIRECTV programming, you will have one guide: the TV program guide.

You can access the program guides by:

- Pressing the GUIDE button on the remote control, or
- Pressing MENU on the remote control and selecting *Program Guide*.



Note that when you access a program guide, you view the guide corresponding to the type of programming you are watching. For example, if you are viewing DIRECTV® programming and press the GUIDE button, you will view the DIRECTV® programming guide. Similarly, if you are in TV mode and press the GUIDE button, you will view the TV program guide.

If you are viewing the TV program guide and would like to view the DIRECTV® programming guide, press INPUT on the remote control to view the DIRECTV programming guide.

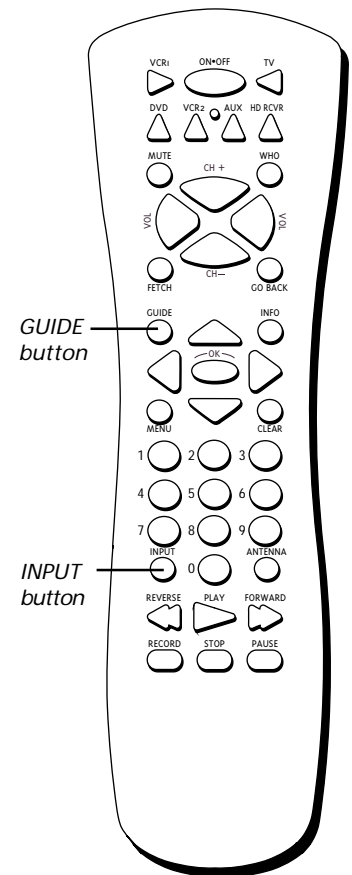

# USING THE PROGRAM GUIDES

## ANATOMY OF THE TV PROGRAM GUIDE

To access the TV program guide:

1. Press the INPUT button on the remote control until the TV icon is highlighted in the channel banner.
2. Press GUIDE on the remote control. The following diagram shows you the kind of information you will see in the TV program guide. Note that the availability of TV program titles and information is dependent upon information provided by local broadcasters.

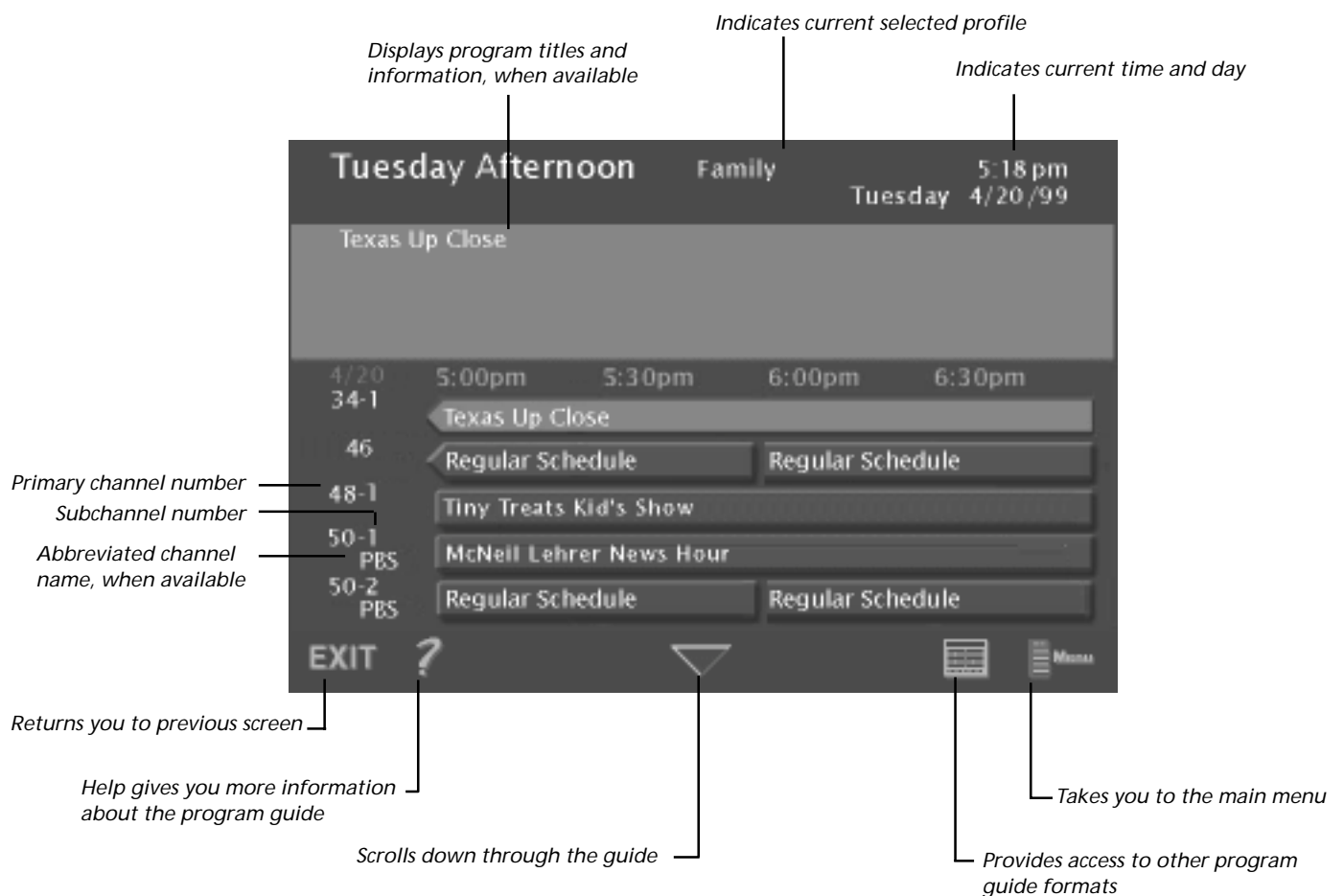

When you are viewing the TV program guide, you can press INPUT and view the DIRECTV® programming guide if you subscribe to DIRECTV programming.

# USING THE PROGRAM GUIDES

## ANATOMY OF THE DIRECTV PROGRAM GUIDE

To access the DIRECTV® programming guide, you must subscribe to DIRECTV service. Press the INPUT button until the DIRECTV icon in the channel banner is highlighted, then press GUIDE on the remote control. The following diagram shows you the kind of information you will see in the DIRECTV® programming guide.

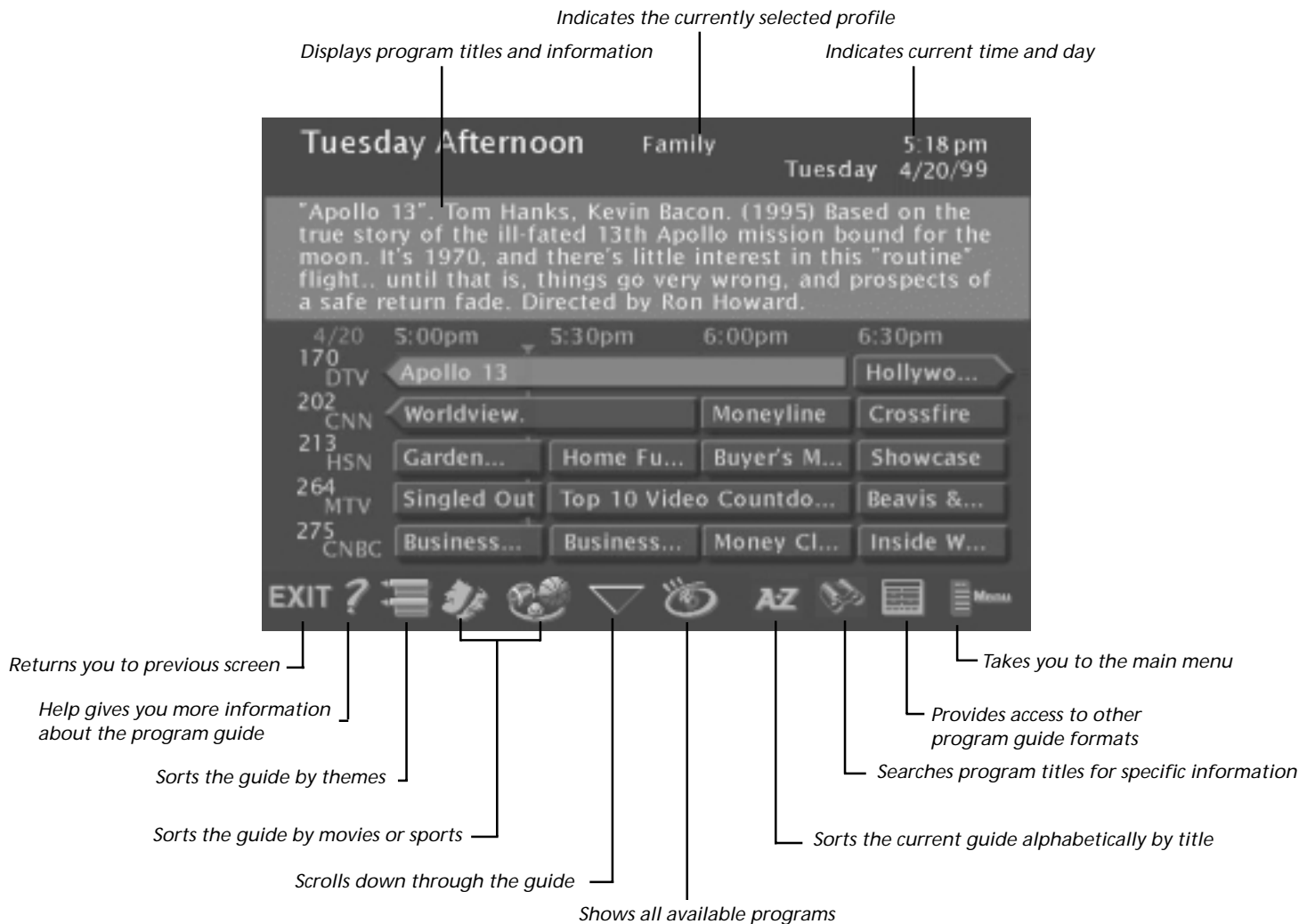

When you are viewing the DIRECTV programming guide, you can press INPUT and view the TV program guide.

# USING THE PROGRAM GUIDES

## GETTING AROUND IN THE GUIDES

There are several ways to change channels and move around the TV and DIRECTV® programming guides.

- **Point to channels with the number buttons (0-9)**  
You can quickly highlight any channel in the program guides by entering the channel number with the number buttons (0-9). For example, to highlight channel 228, press the numbers 2-2-8 and press OK on the remote control. To highlight channel 73, press 7-3 and OK.
- **Scroll channel by channel**  
The programs that you see on the TV screen make up one section—or page—of the total program guide. You can scroll to other sections using the arrows: highlight other times with the left and right arrows; highlight other channels with the up and down arrows.
- **Scroll page by page**  
If you want to scroll up or down through the program guides faster, press the channel up and down buttons on the remote control. The highlight scrolls a page at a time.

To view a listing of future programming in the guide, continuously press the right arrow button on the remote control to scroll to the right.

## TUNING TO A PROGRAM

- To tune directly to a current program listed in a guide, highlight the program name and press OK.
- To see information about a program or channel in the guide, highlight the program or channel name and press INFO.

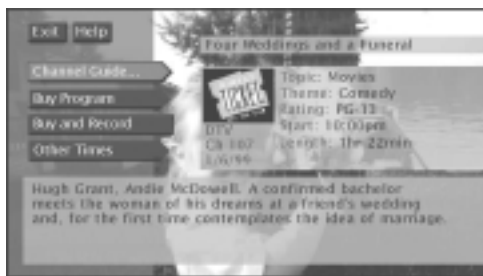

After you highlight a program name and press INFO, the Program Details screen appears and gives you several options.

Then, if the program is not a Pay Per View (PPV) program, you can select:

- *View Channel* to tune to that channel
- *Channel Guide* to see a program lineup for that channel
- *Record Program* to set up a timer to record that program
- *Other Times* to see what other times the program is available

The options available to you may vary according to the type of program you select. If the program is PPV, you will have the options to buy or buy and record the program.



# USING THE PROGRAM GUIDES

## THE OTHER GUIDES ICON

Besides the Detail Guide, Grid Guide, and SurfGuide™, there are more guide formats. The *Other Guides* icon at the bottom of the program guides lets you sort the guides by different variables, such as by channels, data, channel lists, and channel groups.



*Other Guides icon*

- **SurfGuide** (available with DIRECTV only) Displays seven DIRECTV channels in a half-hour time-and-channel format, if you subscribe to DIRECTV® programming. The full name of the program and its rating are listed at the bottom of the screen. Press the right arrow button to extend the SurfGuide to show two hours of programming.
- **Channel Guide** Displays a channel's DIRECTV® or TV programming schedule in a channel-by-channel format. You may also directly enter channel numbers and press OK to go to another channel's listing.

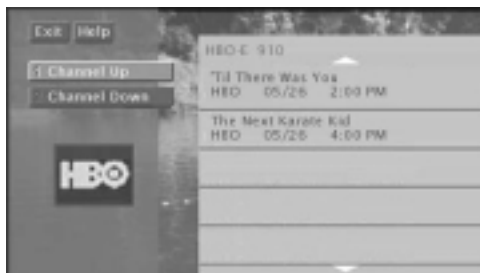

*Channel Guide lets you see what programs are on a specific channel.*

- **Guide Data** Shows you the future guides that are available and lets you select one to view in either the DIRECTV® or TV programming guide.

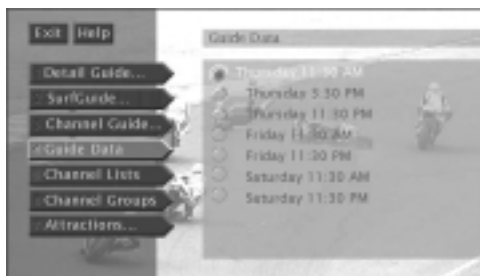

*Guide Data shows you future guides.*

- **Channel Lists** Displays a list of profiles. You can choose a profile from this list and the guide will display only the DIRECTV or TV channels which have been included in that profile's channel list. Another way of accessing a profile's channel list is by pressing WHO on the remote and scrolling through profiles. For more information about including channels in a profile list, see the section "Using Profiles" in this book.
- **Channel Groups** Lets you sort only the DIRECTV® programming guide to include only channels that fall into the selected category. For example, you could sort the DIRECTV guide by Pay Per View movies that are available at a future time.
- **Attractions...** Displays a list of DIRECTV channels that show coming attractions and special events information.

# USING THE PROGRAM GUIDES



The Attractions Guide shows coming DIRECTV events and programs.

## EXITING A PROGRAM GUIDE

There are three ways to exit a guide:

- Highlight a channel and press OK.
- Highlight *Exit* and press OK.
- Press CLEAR or GO BACK on the remote control.

## SORTING THE DIRECTV® PROGRAMMING GUIDE

Sorting the guide is a way of organizing the DIRECTV® programming guide to show only the types of programs that interest you. There are several on-screen buttons that sort the DIRECTV guide in different ways.



The Sorting icons appear at the bottom of the Grid Guide and Detail Guide.



# USING THE PROGRAM GUIDES

## SORTING THE DIRECTV® PROGRAMMING GUIDE BY TOPICS

The topics icon at the bottom of the DIRECTV® programming guide sorts the guide according to the current user's preferences. Select the topics icon to sort the guide.

After you select the topics icon, it changes to the topics themes icon. Select the topics themes icon to edit the current user's themes preferences. These preferences are saved in each user's profile.



Checkmark the themes that interest you.

Checkmark the themes you would like to appear when you select the topics icon in the guides. Programming that fits the description of checkmarked themes will appear in the DIRECTV® programming guide when you sort by the topics icon.

## SORTING THE DIRECTV® PROGRAMMING GUIDE BY MOVIES

Select the movies icon at the bottom of the DIRECTV® programming guide to tell the guide to list only DIRECTV movies. After you select the movies icon, it changes to a movies themes icon.

Select the movies themes icon to sort the guide to list movies by type, such as comedies or musicals.



Select a movie theme that interests you.



Topics icon



Topics themes icon



Movies icon



Movies themes icon

# USING THE PROGRAM GUIDES

## SORTING THE DIRECTV® PROGRAMMING GUIDE BY SPORTS

Select the sports icon to tell the DIRECTV® programming guide to list only DIRECTV sporting events. After you select the sports icon, it changes to the sports themes icon.

Select the sports themes icon to sort the guide to list sports by type, such as basketball or soccer.



*Sports icon*



*Select a sports theme that interests you.*



*Sports themes icon*

## LISTING ALL DIRECTV® PROGRAMMING

The all icon resets the DIRECTV® programming guide to show all available topics, channels and listings for the current profile.



*All icon*

## SORTING THE DIRECTV® PROGRAMMING GUIDE ALPHABETICALLY

AlphaSort™ lists all the program titles in the DIRECTV® programming guide in alphabetical order. You can also find this icon in the channel banner. Select the AlphaSort icon to search for specific program titles that are in the guide. After listing programs whose first letter or number match your entry, it lists programs in the current DIRECTV programming guide that have your entry anywhere in the title.

In the AlphaSort menu, use the arrow buttons on your remote control to highlight a character, then press OK.



*AlphaSort icon*

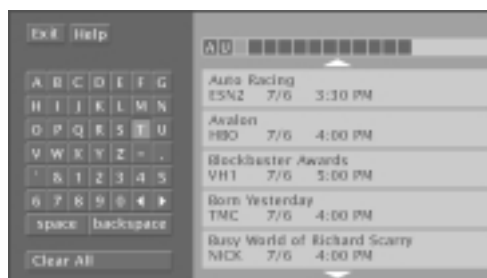

# USING THE PROGRAM GUIDES

For example, to search for the program Auto Racing, the first letter you should highlight and select is "A." (Words like "The", "A", and "An" appear at the end of a title.) All titles that begin with "A" appear in the AlphaSort list. Next, enter the letter "U". All titles beginning with "AU" appear in the list. Programs that contain "AU" anywhere in their titles will appear at the end of the list.

## FINDING DIRECTV PROGRAMS USING SCOUT™

The Scout icon at the bottom of the DIRECTV® programming guide lets you assign "Scouts" to search all DIRECTV programming guides (both current and future) for very specific program title information.

To use Scout:

1. Highlight the Scout icon in the program guide and select it.
2. Highlight Scout 1-8 from the next screen and press OK. If you're setting up a new Scout, make sure to select a Scout **without** a check beside it, since the check means you have already set up that Scout.

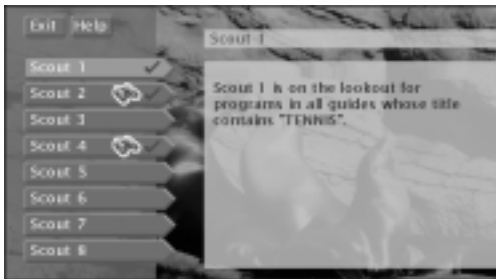

Select a Scout without a check to set up a new Scout.

3. Select *Enter Text* to set up the information the Scout will look for in all program guide titles.
4. Use the on-screen keyboard to enter the desired search parameters. For example, if you are interested in tennis events, enter a common term you might see in program titles, like "tennis."



Select *Enter Text* to set up a Scout.



Scout icon

On-screen icons represent the status of scout:



Indicates a Scout is set to find specific information.



Indicates a Scout has found the information you specified.

# USING THE PROGRAM GUIDES

5. Select *Run Scout*. Scout will search for information in all DIRECTV® programming guide titles.
6. Check the Scout's results by selecting the Scout icon from the program guide or channel banner, then selecting the Scout with binoculars icon next to it.
7. Select *Scout Results*. If the characters you entered appear anywhere within a program title, the program will be included in the Scout Results program list. If no match is found, turn off your receiver for approximately 30 minutes and then check again.



*Scouts look for specific program information.*

## THE OTHER ICONS

These icons are located on both the DIRECTV and TV program guides.

### EXIT

Exits the guide and returns you back to where you were before entering the guide.



*Exit icon*

### HELP

Brings up additional information about the guide. Press OK to continue.



*Help icon*

### DOWN ARROW

Allows you to scroll down through other channels in the guide. Highlight the down arrow, and then press either OK or the down arrow on the remote to scroll down through the program guide.



*Arrow icon*

### THE MAIN MENU

Brings up the main menu. Press OK to continue.



*Main menu icon*

# AUDIO CONTROLS AND TIMERS

## SOME ADVANCED FEATURES

The following section tells you how to adjust the audio quality of your HD receiver. It also shows you how to set timers to record or turn on your receiver at a specified time.

**1** SETUP AND CONNECTIONS



**2** USING THE REMOTE



**3** BASIC OPERATION



**4** USING THE PROGRAM GUIDES



**5** AUDIO CONTROLS AND TIMERS



**6** USING THE PROFILES



**7** SYSTEM OPTIONS AND PREFERENCES



**8** GETTING ASSISTANCE



**9** REFERENCE

# AUDIO CONTROLS AND TIMERS

## AUDIO CONTROLS

The Audio menu lets you adjust the controls that deal with the TV's audio outputs. To access the Audio menu, press MENU on the remote, then select *Audio* from the main menu.

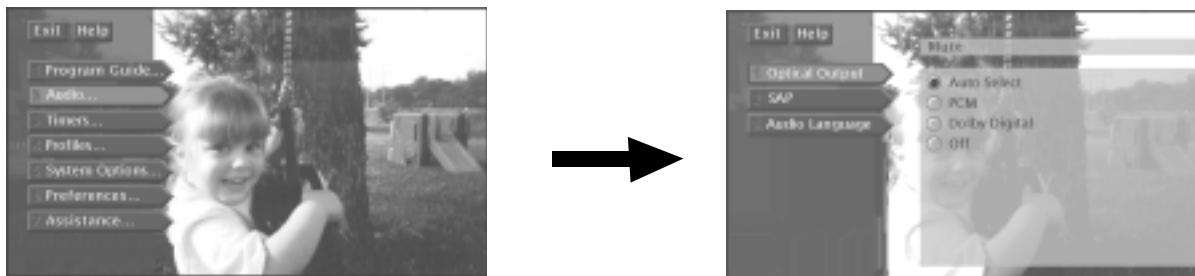

## OPTICAL OUTPUT

When the HD receiver is connected to an optional, compatible, six-channel amplifier/receiver and speakers via the DIGITAL AUDIO OUT jack on the back panel, you receive Dolby Digital Surround Sound, if transmitted. Use the Optical Output menu to specify Auto Select, PCM (Pulse Code Modulation), Dolby Digital<sup>†</sup>, or Off.

Select *Auto Select* if your HD receiver is connected to a Dolby Digital and PCM decoder. Select *Dolby Digital* if the HD receiver is connected to a Dolby Digital only decoder; when broadcast, it will provide six independent soundtrack channels through the optical output jack (labeled DIGITAL AUDIO OUT) on the back of the HD receiver to an optional, compatible 6-channel amplifier receiver. Select *PCM* if it is connected to a PCM-only decoder; it will then provide two independent soundtrack channels. Select *Off* if you want no audio provided.

### About Dolby Digital Sound

Dolby Digital (when available) provides 6 independent soundtrack channels through the optical output jack. This HD receiver has an S/PDIF [IEC-958] digital PCM or Dolby Digital encoded output (labeled DIGITAL AUDIO OUT) that can be connected to an external Digital Audio Receiver/Decoder equipped with a compatible optical input. With additional equipment you can enjoy more dynamic and realistic sound.

#### Requirements for receiving Dolby Digital sound:

- Digital Audio Receiver/Decoder with digital optical input jack
- Programming with digital soundtrack
- Optical (S/PDIF) cable
- 6 speakers (left, left surround, right, right surround, center and sub-woofer)

<sup>†</sup> Manufactured under license from Dolby Laboratories. "Dolby" and the double-D symbol are trademarks of Dolby Laboratories. Confidential Unpublished Works. ©1992-1997 Dolby Laboratories, Inc. All rights reserved.

# AUDIO CONTROLS AND TIMERS

## Connections:

The diagram below illustrates the equipment connections and home theatre speaker arrangements. Check your equipment's user manuals for more detailed connection information. (Note: older digital equipment may not be compatible with the Dolby Digital bitstream. Such a connection can create a high level of noise that may be harmful to your ears, and could damage headphones or speakers.)

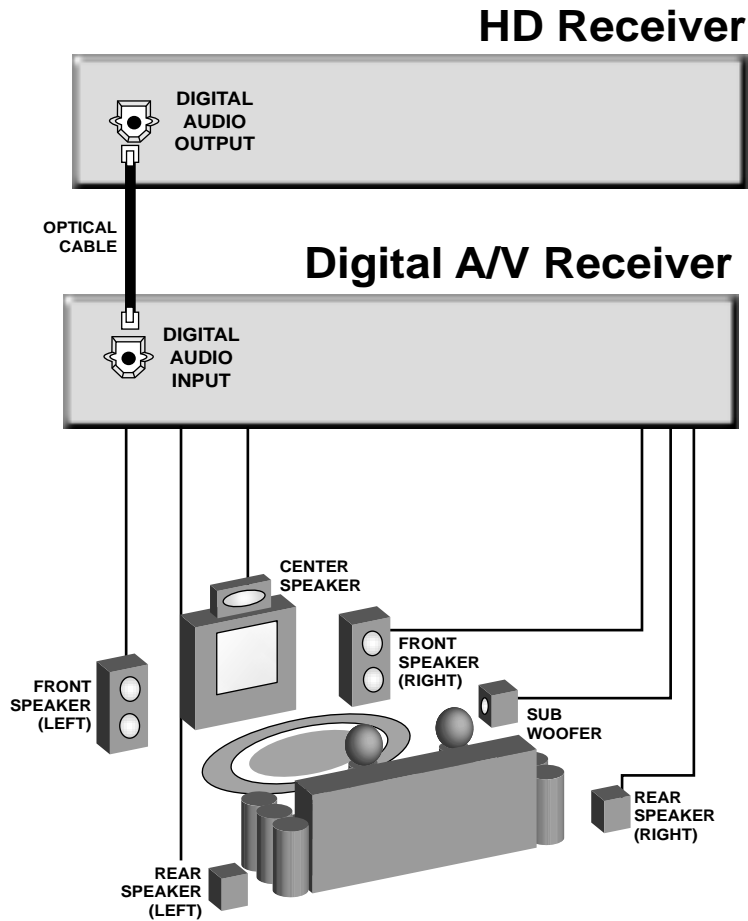

## Please Read Before Using the Digital Audio Out Jack

This HD receiver's optical digital output jack fully complies with the international standard governing this type of jack (IEC958), and is designed for connection to a Dolby Digital decoder. Older equipment, some of which is not fully compliant with IEC958, may not be compatible with the Dolby Digital bitstream. Such a connection using anything other than a PCM, Dolby Digital, or Dolby Pro Logic receiver or decoder could create a high noise level, causing damage to headphones or speakers.

# AUDIO CONTROLS AND TIMERS

## SAP (SECOND AUDIO PROGRAM)

The SAP (Second Audio Program) menu lets you choose the default setting for SAP when it is available. When set to *SAP On*, SAP plays the program's second audio program, if one is available. SAP is also used to broadcast a program's audio with descriptions of the video for the visually impaired or in a second language. SAP is broadcast in mono and is not available for digital programs.

## AUDIO LANGUAGE

The Audio Language menu lets you choose the default audio language you want to hear when it is available. The system will automatically set the audio program to the selected audio language when the channel you are viewing is either a DIRECTV or a digital channel and the specified language is available.

In the Audio Language menu, highlight the audio language you want using the up and down arrows, then press OK to select.

You will also find an audio language icon in the channel banner.



*Audio Language Icon*

If the icon is highlighted while watching a digital (ATSC) or DIRECTV channel, two or more audio languages are available. Selecting the icon repeatedly scrolls through and plays the options.

If the icon is highlighted when watching an analog (NTSC) TV channel, a Second Audio Program (SAP) is available. Selecting the icon will play the SAP for the current channel until the channel is changed.



# AUDIO CONTROLS AND TIMERS

## TIMERS FEATURE

The Timers feature allows you to preset your HD receiver to automatically tune to a particular channel at a predetermined time.

To use the Timers feature, select *Timers* from the main menu to bring up the Timers screen. Select a Timer (1-8) and then use the arrow buttons to complete the on-screen sentence. When the sentence is complete, select *Run Timer*.

## SETTING UP TIMER RECORDINGS

The Timers feature allows you to set up timer recordings if you have connected the VCR Controller to your HD receiver and told the receiver what type of VCR you are using. See the section "Setup and Connections" for details.



Complete the on-screen sentence to set up a timer. Make sure to specify which antenna you want to use.

## RECORDING WITH TIMER

If you choose *Record* instead of *Watch* when setting the Timer (and have set up your VCR as discussed in the "Setup and Connections" section), the Timer will turn on your VCR, then start and stop recording a program.

To record with timers:



- Your VCR must be preset to the DIRECTV output channel (RF, Line, or Video).
- Your VCR must be off at the time the program is to start recording.
- You must insert a recordable tape into the VCR.

### Editing or Canceling a Timer

From the Timers screen, select the Timer you want to edit or cancel, and then do the following:

- Use the arrow buttons to edit the Timer, then select *Run Timer*.
- Select *Clear Timer* to cancel the timer.
- To watch the program daily or weekly, edit that program's timer.

On-screen icons are an easy way to understand the timers:

-  indicates that the timer is set.
-  indicates that the timer is set for a PPV.
-  indicates a timer conflict.

Note that when your timed recording begins, your HD receiver will output signals via the Audio/Video jacks or RF outputs instead of the HD MONITOR jack, if connected.

# AUDIO CONTROLS AND TIMERS

## SCHEDULE A TIMER WITH THE RECORD BUTTON

You can schedule a recording directly from the guide.

1. With a program highlighted, press the RECORD button on the remote. The *Program Details* screen appears.
2. To schedule a timer to record, select:
  - *Record Program* to set a timer to record the program.
  - *Buy and Record* (available with Pay Per View programs) to purchase the program and set up a timer to record the program. Some *Buy and Record* programs may have a different purchase price.

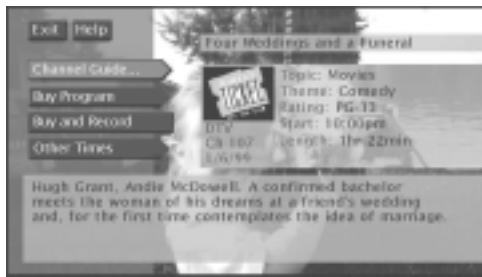

The options available to you may vary according to the type of program you select.

Also remember that:

- Your VCR must be preset to the DIRECTV output channel (RF, Line, or Video).
- Your VCR must be off at the time the program is to start recording.
- You must insert a recordable tape into the VCR.

Note that when your timed recording begins, your HD receiver will output signals via the Audio/Video jacks instead of the HD MONITOR jack, if connected.

# USING THE PROFILES

## WHAT'S A PROFILE?

This section describes the user profiles feature. It includes information about:

- creating a profile's TV and DIRECTV viewing lists.
- setting spending limits.
- setting DIRECTV, TV, and movie rating limits.
- blocking unrated TV programs.
- locking and unlocking a profile.

**1** SETUP AND CONNECTIONS



**2** USING THE REMOTE



**3** BASIC OPERATION



**4** USING THE PROGRAM GUIDES



**5** AUDIO CONTROLS AND TIMERS



**6** USING THE PROFILES



**7** SYSTEM OPTIONS AND PREFERENCES



**8** GETTING ASSISTANCE



**9** REFERENCE

# USING THE PROFILES

## ABOUT PROFILES

When you select *Profiles* from the main menu, you can create four different profiles in addition to the default "Family" profile. You can set up specific channels, rating limits, viewing hours, and spending limits for each profile. After you've set up these profiles, exit the menu system. Then press the WHO button on the remote control to scroll through your profiles and press OK to access a certain one.

But first, personalize a profile by entering a name.

1. Select *Profiles* from the main menu.
2. Select a profile to edit: *User 1*, *User 2*, *User 3*, or *User 4*.
3. Select *Edit User Name* from the next menu.
4. Use the up, down, and right arrows on the remote control to find and select a letter.



You can personalize each profile.

To continue editing the profile, select *DIRECTV Setup* (if you have ordered DIRECTV® programming) or *TV Setup*. The following sections describe how to set up these features.

## THE DIRECTV SETUP

The DIRECTV Setup menu item is only accessible if you subscribe to DIRECTV® programming. Through this menu you can establish DIRECTV channel lists, set spending limits, set viewing hours, and set rating limits for DIRECTV® programs.

## EDITING CHANNELS IN A DIRECTV LIST

You should create a DIRECTV channel list to establish which DIRECTV channels the selected profile can access. To create the DIRECTV channel list:

1. Highlight and select a user name, then select *DIRECTV Setup*.
2. Highlight *Edit Channels* and press OK.

Use the MENU button on the remote control to bring up the main menu, use the arrows to highlight an option, and press OK to select it.

You can also set up profiles as categories instead of as users. For example, name a profile "Sports" and include only sports channels in the profile. Or, name it "Movies," include only movie channels, and set a rating and spending limit for yourself or your family.

# USING THE PROFILES



Check the channels you want to include in the list (programming subject to change).

3. Use the arrow buttons to point to a DIRECTV channel, and press OK to remove (or replace) the check mark. To go directly to a certain channel, enter its number using the digits on the remote control. Or, page through the list using the channel up and down buttons.

Checkmarked items appear in the DIRECTV channel list. In other words, when you select that profile and begin surfing through DIRECTV channels with the channel up and down buttons, only the checkmarked channels will appear as you surf.

## SELECTING OR DELETING ALL DIRECTV CHANNELS

You might be able to save time when creating a DIRECTV channel list by using the *Select All Chans* option or the *Delete All Chans* option to either add or delete all channels before removing or adding individual channels.

Also, DIRECTV program providers may make additional channels available. To prevent new channels from appearing in a profile channel list, choose *Delete All Chans* and checkmark only the channels you want to appear in the list.

## SETTING THE DIRECTV SPENDING LIMIT

Use the *Spending Limit* option to indicate a profile's per-event spending limit for Pay Per View (PPV) programs. To set the spending limit, choose the user profile name, select *DIRECTV Setup*, then follow these steps:

1. Highlight *Spending Limit*, and press OK.

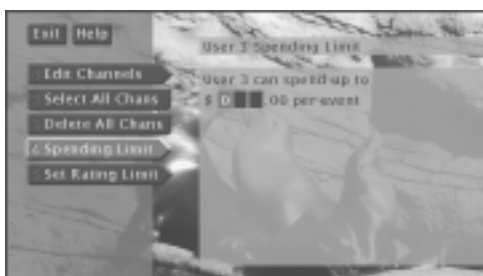

You can set a per-event spending limit for each profile.

### Tip

Another way of accessing spending limits is to select *System Options* from the main menu, and then select *Purchases*. You can then select *Spending Limit* and set limits for all users from one location instead of accessing each profile individually.

# USING THE PROFILES

2. Use the digits or the up and down arrow buttons on the remote control to enter a single-program spending limit.
3. Lock the system. See "Locking the System" near the end of this section for details.

After a spending limit is set and the system is locked, you must enter a password to purchase a Pay Per View program that costs more than your spending limit allows. The system will then temporarily unlock the limits you have set until the power is turned off. When the system is turned back on, the system will be locked again.

## SETTING THE DIRECTV RATING LIMIT

The Set Ratings Limit menu enables you to set a maximum viewing limit for rated DIRECTV® programming.

- Note that the ratings limit cannot be enforced if a DIRECTV program has not been rated, if rating information for that program is not transmitted by the program provider, or if the system has not been locked.
1. Select a user.
  2. Select *DIRECTV Setup*.
  3. Highlight *Set Rating Limit* and press OK.

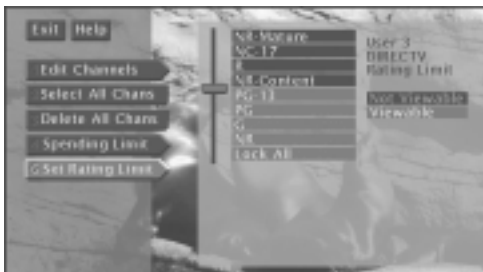

Use the arrow buttons on the remote control to move the selector up and down.

4. Use the up and down arrows to move the rating selector to the highest rating you want to be able to view. In the preceding illustration, movies that are rated up to and including a PG-13 rating can be viewed.

After the rating limit is set and the system is locked, you must enter the system password to watch programs with a rating higher than the limit. The system will then temporarily unlock the limits you have set until the power is turned off. When the system is turned back on, the system will be locked again.

### Important!

You need to lock the system in order for rating limits, channel limits, viewing hours, and spending limits to go into effect.

To edit the limits after you lock the system, you need to enter the system password. See "Locking the System" for details.

Please note that the rating limit you set while in the DIRECTV Setup menu apply only to the specified profile and to DIRECTV programs—they do not apply to TV programs.

To set limits for TV programming, select a profile, select *TV Setup* and then select *Set TV Rating* or *Set Movie Rating*.

# USING THE PROFILES

## THE TV SETUP

You can establish TV channel lists, set spending limits, and set rating limits for TV programs using the TV Setup menu.

## EDITING CHANNELS IN A TV LIST

You can create a TV channel list to establish which TV channels (including both analog and digital) the selected profile can access. To create the TV channel list:

1. Select a user.
2. Select *TV Setup*
3. Select *Edit Channels*.

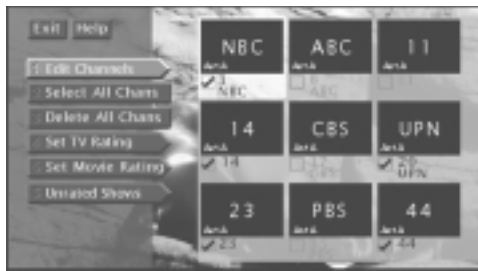

To start, you can add or delete all channels.

4. Use the arrow buttons to highlight a TV channel, and press OK to remove (or replace) the check mark. To go directly to a certain channel, enter its number using the digits on the remote control. Or, page through the list using the channel up and down buttons.

Checkmarked items appear in the channel list. In other words, when you select that profile and begin surfing through TV channels, only the checkmarked channels will appear as you surf. Note that the only channels you can add or remove from a list are ones that were found during the channel search (see the "Getting Assistance" section for details on automatically searching for channels).

## SELECTING OR DELETING ALL TV CHANNELS

You might be able to save time when creating a TV channel list by using the *Select All Chans* option or the *Delete All Chans* option to either add or delete all channels before removing or adding individual channels.

Also, terrestrial program providers may make additional channels or subchannels available. To include new channels in your TV channel list:

1. Select *System Options* from the main menu, then select *Channel Search*. The system will run a channel search, making it aware of the new channel(s).
2. Select *Profiles* from the main menu.
3. Select the user profile name, then *TV Setup*.
4. Choose *Edit Channels* and checkmark the new channel.

**Don't forget about the CLEAR button.**

Press the CLEAR button on the remote control to remove the on-screen menus.

Note that if you're using two terrestrial antennas, pressing the ANTENNA button on the remote allows you to edit the other antenna's channel list when you are in TV mode.

Another way to add a channel is to directly tune to it using the digit buttons on the remote control. If the system can obtain that channel's signal, it will be added into the channel list.

# USING THE PROFILES

## SETTING THE TV RATING

The Set TV Rating menu enables you to program your HD receiver so children cannot see certain programs or channels.

The last three choices in the TV Setup menu involve ratings software inside your HD receiver (often called V-Chip) which allows you to “block” TV programs and movies based on violence, sex, or other content you may believe children should not view. In other words, it lets you program your HD receiver so it will not display certain programs. Once you block programs, you or other adults are not limited to only parent-approved programs; you can “unblock” programs by entering the system password.

The ratings software inside your HD receiver is initially turned “off,” so if you choose not to implement it, you can just ignore it.

When turned “on,” the ratings software reads a code that most broadcasters send with programs. That code tells the software the program’s age-based rating (TV-MA, TV-14, etc.) and content themes (Violence (V), Adult Language (L), etc.). If you have blocked the rating or content themes that the program contains, you will receive the message, “Program exceeds the TV rating limit you set,” when you turn to that particular channel. Broadcasters are not required to provide ratings. However, you can block out programs that have been given a rating of “Not Rated,” and programs that are considered “unrated” because no code has been sent by the broadcaster.

The age-based ratings and content themes you can block are listed in the table below.

Age-Based Rating	Description and Content Themes for Age-Based Ratings
TV-MA	Mature Audience Only. Specifically designed to be viewed by adults and may be unsuitable for children under 17. It contains one or more of the following content themes: <b>crude indecent language (L), explicit sexual activity (S), or graphic violence (V).</b>
TV-14	Parents Strongly Cautioned. Contains some material that many parents would find unsuitable for children under 14. Parents are strongly urged to exercise greater care in monitoring this program and are cautioned against letting children under the age of 14 watch unattended. This program contains one or more of the following content themes: <b>intensely suggestive dialogue (D), strong coarse language (L), intense sexual situations (S), or intense violence (V).</b>
TV-PG	Parental Guidance Suggested. Contains material that parents may find unsuitable for younger children. Many parents may want to watch it with their younger children. The program contains one or more of the following content themes: <b>some suggestive dialogue (D), infrequent coarse language (L), some sexual situations (S), or moderate violence (V).</b>
TV-G	General Audience. Most parents would find this program suitable for all ages. It contains <b>little or no sexual dialogue (D), no strong language (L) or situations (S), and little or no violence (V).</b>
TV-Y7	Directed to Children 7 years and older. Designed for children ages 7 and above. It may be more appropriate for children who have acquired the developmental skills needed to distinguish between make-believe and reality. Themes and elements in this program may include mild <b>fantasy violence (FV)</b> or comedic violence, or may frighten children under the age of 7.
TV-Y	All Children. Themes and elements in this program are designed for a young audience, including children from ages 2-6. It is not expected to frighten younger children.



# USING THE PROFILES

To set TV programming limits:

1. From the main menu, select *Profiles*.
2. Select the user name you would like to set limits for through the *Profiles* menu.
3. Select *TV Setup* from the next menu.
4. Select *Set TV Rating*.

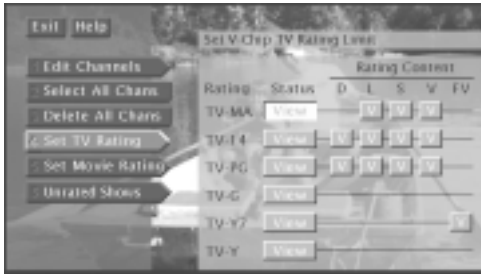

Selecting TV Rating allows you to set a limit for TV programs based on rating and content.

Remember you are only blocking TV programs and movies for the one profile you select in the Profiles menu. If you would like to block different programs for different users, be sure to complete the process for each of them.

Once you get to the Set TV Rating screen, use the arrows and OK buttons on your remote control to change the status of a TV program rating from *View* to *Block*. The following sections give you more details about how to change the status of TV program limits.

You must remember to lock the system for both TV and DIRECTV rating limits to take effect.

## THE RATING LIMIT SCREEN

Below is an example of where items are located within the Rating Limit screen.

### Age-Based Rating Limit

*Lists the available ratings you can block or view with the rating status buttons.*

### Rating Status Buttons

*Lets you know whether the status of the age-based rating limit to the left is View or Block.*

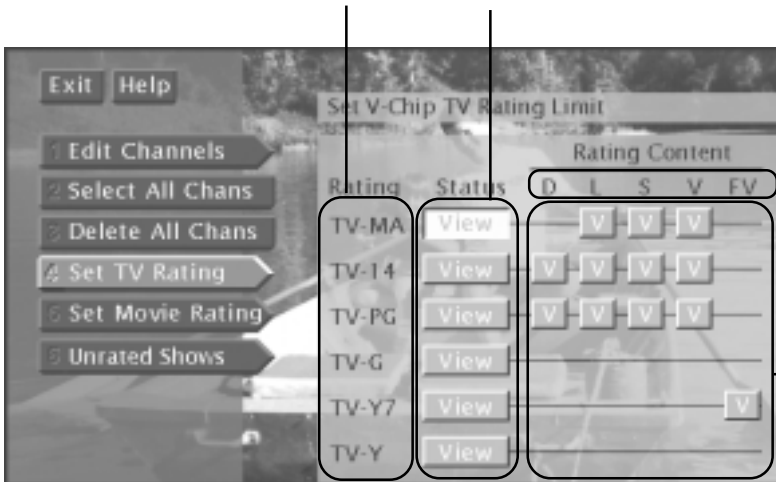

### Content Themes

*Lists the content themes you can block or view with the content status buttons.*

### Content Status Buttons

*Lets you know which content themes are available for that rating, and whether the status of the content theme is View (V) or Block (B).*

# USING THE PROFILES

## BLOCKING AGE-BASED RATINGS

You can automatically block all program ratings above a specified age-based rating level. For example, if you only want your child to watch programs that have a TV-G rating and lower (in other words, you want the child to watch only TV-G, TV-Y7, and TV-Y programs), then you need to block other programming with higher ratings.

To block programs with higher ratings:

1. First, determine the lowest level rating you do not want the child to watch.
2. Highlight the rating status button that corresponds with the lowest rating you do not want the child to watch. (In the example above, you would point to the rating status button corresponding to TV-PG, since the highest rating you want her to watch is TV-G.)
3. Press OK to change the button from *View* to *Block*. The status for this and all higher ratings automatically change to *Block* (and *B*).

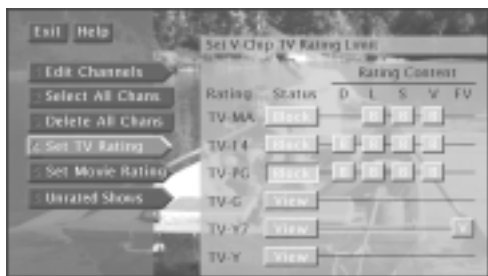

Changing the TV-PG rating status button from *View* to *Block* causes the buttons for the higher ratings and content to change to *Block* and *B*.

4. Press the left arrow button on the remote control to return to the menu.

## Viewing Age-Based Ratings

After you block age-based ratings, you have the option of going back and changing some of the ratings to *View*.

1. Determine the rating you want to view that is currently blocked.
2. Use the arrows on the remote control to highlight the rating status button, such as TV-14, whose status is *Block*.
3. Press OK to change the status to *View*. Your child would then be able to watch all programs with a TV-14, TV-G, TV-Y7, and TV-Y rating.

Note that the content theme buttons corresponding to TV-14 change to *View* as well. They and the age-based rating status buttons are the only buttons that automatically change back to *View* when you complete this process.

When you change the status of a rating to *Block*, the system will automatically block higher ratings and all corresponding content themes.

### Hierarchy of Age-Based Ratings

TV-MA	Mature Audience Only
TV-14	Parents Strongly Cautioned
TV-PG	Parental Guidance Suggested
TV-G	General Audience
TV-Y7	Directed to Children 7 Years and Older
TV-Y	All Children

# USING THE PROFILES

## Blocking Specific Content Themes

You can block programs based on their content. (Content is represented by the D, L, S, V, and FV on your screen. See "Setting the TV Rating" for details.) When you block a content theme for a particular rating, you automatically block that content theme for higher rated programs as well.

For example, if you do not want your child to watch programs that have adult language (L) rated TV-PG or higher, you need to block adult language in all programming rated TV-PG and above.

To block program content:

1. Determine the lowest level of content you do not want the child to watch.
2. Highlight the content button that corresponds with the lowest content you do not want the child to watch. (In the example above, you would highlight the *V* button located under the L and to the right of TV-PG.)
3. Press OK to change the button from *V* to *B*. All higher ratings' language content theme button will automatically change to *B*.

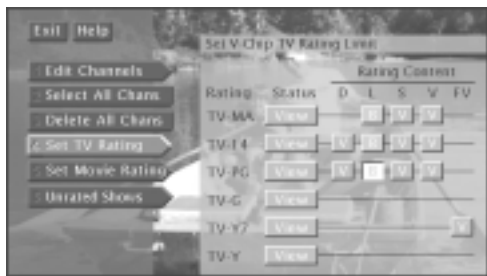

Selecting the content theme button corresponding with adult language (L) and TV-PG blocks all programs with adult language (L) rated TV-PG and higher.

4. Press the left arrow button on the remote to return to the menu or exit the screen.

## Viewing Specific Content Themes

After you block specific content themes, you have the option of going back and changing some of the content themes back to View (V):

1. Determine the content themes you want to change to View (V).
2. Use the arrows to highlight a particular content button, such as the *B* under language (L) corresponding with TV-14.
3. Press OK to change its status back to *V*. Your child would then be able to watch programs with TV-14 adult language content, but not programs with TV-PG or TV-MA language content.

Note that only the content theme status button corresponding to TV-14 language (L) changes to View (V). Higher rated content theme buttons, such as that for TV-MA language, do not change.

You must remember to lock the system for both TV and DIRECTV rating limits to take effect.

Content Themes	
D	Sexually Explicit Dialogue
L	Adult Language
S	Sexual Situations
V	Violence
FV	Fantasy Violence

You must remember to lock the system for both TV and DIRECTV rating limits to take effect.

# USING THE PROFILES

## SETTING THE MOVIE RATING

You set movie rating limits by blocking movies rated above a specified level. To access the Set Movie Rating menu:

1. From the main menu, select *Profiles*.
2. Select the user you for whom you would like to set limits.
3. Select *TV Setup* from the next menu.
4. Select *Set Movie Rating*.

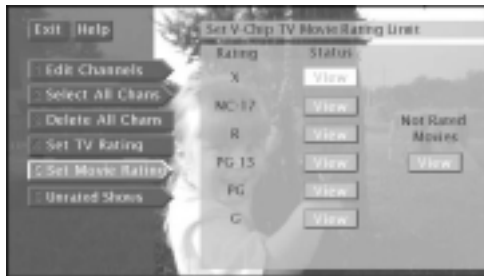

Selecting *Set Movie Rating* allows you to set a limit for movies based on rating.

## Blocking Movie Ratings

If you only want your child to watch movies that have a PG rating and lower (in other words, movies rated PG and G), then you can automatically block out all other movies with higher ratings.

To block movies:

1. Determine the lowest level rating you do not want the child to watch.
2. Highlight the rating status button corresponding to the lowest rating you do not want the child to watch. (In the example above, you would highlight the rating status button corresponding to PG-13, since the highest rating you want the child to watch is PG.)
3. Press OK to change the button from *View* to *Block*. All higher ratings' *View* buttons will automatically change to *Block*.

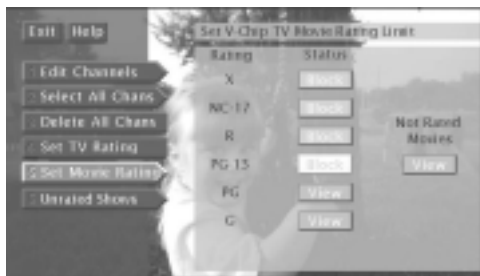

Change the button from *View* to *Block* and all higher rated movies will also be blocked.

4. Press the left arrow to return to the menu or exit the screen.

Please note that the rating limits you set while in the TV Setup menu apply only to TV programs—they do not apply to DIRECTV programs.

To set limits for DIRECTV® programming, select a profile, select *DIRECTV Setup* and then select *Set Rating Limit*.

You must remember to lock the system for both TV and DIRECTV rating limits to take effect.

# USING THE PROFILES

## Viewing Moving Ratings

After you block movie ratings, you have the option of going back and changing some of the rating status buttons back to View:

1. Determine the movie ratings you want to change to *View (V)*.
2. Use the arrows to highlight the status button you want to change.
3. Press OK to change its status back to *View*.

For example, if movies with a rating of PG-13 and higher are blocked, you can change the rating status button corresponding with NC-17. Your child would then be able to watch all movies with a G, PG, and NC-17 rating.

Some movies may be given a "Not Rated" rating. After blocking movie ratings, you must separately set "Not Rated Movies" to View to see these movies.

## BLOCKING UNRATED TV SHOWS

Some TV shows are not rated and may contain material you do not want your children to see. These shows must be blocked separately.

To block unrated shows:

1. Select the user for whom you would like to set limits.
2. Select *TV Viewing*.
3. Select *Set TV Rating*.
4. Now select *Unrated Shows*.
5. Highlight the radio button beside your choice of *View Unrated Shows* or *Block Unrated Shows* and press OK to select it.

Note that "unrated" TV shows may include news, sports, political, religious, local and weather programs, emergency bulletins, and public announcements.



Selecting *Unrated Shows* allows the user to view or block all unrated programs.

You must remember to lock the system for both TV and DIRECTV rating limits to take effect.

# USING THE PROFILES

## CHOOSING YOUR PROFILE

Each time you turn on the HD receiver, the Family profile is selected by default. To select a different profile:

1. Press the WHO button to scroll through the profiles in the channel banner.



*The WHO button toggles through the profiles.*

2. When your profile appears, enter your four-digit personal password to access your profile. If the profile is not locked, you can just press OK to activate it.

The channel, spending, ratings and viewing limits associated with the chosen profile will be active only when the system is locked.

# USING THE PROFILES

## LOCKING AND UNLOCKING A USER PROFILE

When you lock a profile, you prevent anyone who does not know the user password from accessing the locked profile. This applies only when they press WHO on the remote control. It does not prevent them from accessing and editing the profile via the main menu if they first enter the system password.

When you lock a profile (excluding "Family"), you lock its channel limits, rating limits, and spending limits. After locking the profile, you need to enter the system password to edit these settings.

1. Choose the profile you want to lock or unlock from the Profiles menu, highlight *Lock User* or *Unlock User*, and press OK.

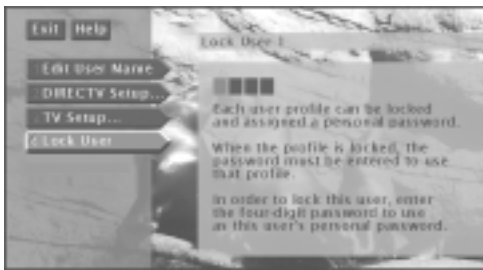

*Locking the user profile protects the limits you set up.*

2. When locking a user, use the arrows or the digits on the remote control to enter a four-digit user password.

Some other things to remember about locking and unlocking profiles are:

- For a lock to be effective, you must exit out of the menu system.
- When you attempt to access a profile's channel that is blocked by one or more limits and the system is locked, you will be asked to unlock the video by entering the SYSTEM password.
- If you enter the system password to override a limit, the lock on the channel banner will turn yellow, and all limits are temporarily unlocked until you turn off the television. When you turn on the television again, the system will be locked, and the Family profile channel list will be active. If you want to re-lock without turning off the television, you can select the lock icon in the channel banner.
- If a profile is locked and you want to access its channels, press WHO on the remote control and then enter the user password.
- If a profile is locked and you want to access its settings, you can access it through the menu system by choosing *Profiles* and then entering the system password. Next, choose the profile name.

### Don't Forget Your Password

If you forget a USER password and the system is locked, you need to unlock the system and then assign a new user password. If the system is not locked, select *Profiles* from the main menu, choose *Unlock User*, and enter a new password.

# USING THE PROFILES

## LOCKING THE SYSTEM

When you lock the system, all limits set up for all profiles are put into effect, regardless of whether the profile is locked or unlocked. Unlocked profiles require no user password to access their channel list if the system is locked.

When the system is locked, you can still access a profile and watch a channel in its channel list (if the profile is locked, however, you must have the user password). Locking the system activates all rating, spending, viewing, and channel limits for all profiles. When you lock the system, no one can modify any of these settings without first entering the four-digit system password.

1. Select *Profiles* from the main menu. Then select *Lock System* and press OK. Or, press INFO on the remote control and select the green unlock icon from the channel banner.

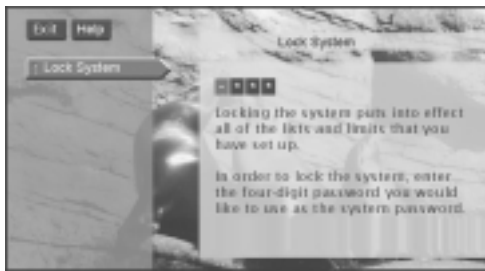

You can lock the system via the channel banner by entering a password.

2. Use the arrows or the digits to enter a four-digit system password.
3. Enter the password a second time to confirm it.

For the changes to be effective, you must exit out of the menu system.

## UNLOCKING THE SYSTEM

When the system is unlocked, the channel, spending, viewing, and ratings limits that you set are no longer in effect. To unlock:

1. Highlight *Unlock System* in the Profiles menu and press OK.
2. Highlight *Yes* and press OK to confirm that you want to unlock the system.

When you attempt to access a channel that is blocked by one or more limits and the system is locked, you will be asked to temporarily unlock the system by entering the four-digit system password.

If you enter the system password to override a limit, all limits are unlocked until you turn off the HD receiver. When you turn on the HD receiver again, the system will be locked, and the Family profile channel list will be selected. If you want to re-lock the system without turning off the HD receiver, you can select the lock icon in the channel banner.

The Lock/Unlock icons in the channel banner are an easy way to lock or unlock the system. Press INFO and select the icon to change the lock status.

- **Green Unlock icon** The system is unlocked. Spending, viewing and other limits can be accessed and changed.
- **Yellow Unlock icon** A password has been entered to override limits. No limits can be accessed or changed in the menu without a system password.
- **Red Lock icon** Limits cannot be accessed or changed without the system password and all limits are in effect.

If you subscribe to DIRECTV® programming and forget the SYSTEM password, contact your satellite program provider's authorization center. If you forget the system password and do not have DIRECTV® programming, remove the access card from the HD receiver's back panel (store it in a safe place, or reinsert it upside down to store in the receiver). Then press and hold the INFO button on the front panel; simultaneously then press and hold the WHO button on the remote control. Continue to hold for three seconds. All passwords will be cleared.



# SYSTEM OPTIONS AND PREFERENCES

## MORE ADVANCED FEATURES

This chapter describes the other options available to you such as:

- selecting a signal source and type
- searching for all available channels
- checking your mailbox
- purchasing programs
- setting up personal preferences
- establishing system settings
- using the FETCH button on the remote control

**1** SETUP AND CONNECTIONS



**2** USING THE REMOTE



**3** BASIC OPERATION



**4** USING THE PROGRAM GUIDES



**5** AUDIO CONTROLS AND TIMERS



**6** USING THE PROFILES



**7** SYSTEM OPTIONS AND PREFERENCES



**8** GETTING ASSISTANCE



**9** REFERENCE

# SYSTEM OPTIONS AND PREFERENCES

## CHANGING THE SIGNAL SOURCE

The Signal Source menu allows you to choose the source from which you would like the signal to come: Antenna A, Antenna B, or DIRECTV. The same can be accomplished using the ANTENNA and INPUT buttons on your remote control. If you misplace your remote control, use the front panel buttons to access this menu and change the signal source.

To access the Signal Source menu:

1. Press MENU on the remote control to access the main menu.
2. Select *System Options* from the main menu.
3. Select *Signal Source* from the next menu.



*Select the appropriate signal source.*

4. Use the arrows and OK to select which source you would like to receive a signal from: Antenna A, Antenna B, or DIRECTV.

## CHANGING THE SIGNAL TYPE

The Signal Type menu lets you choose whether you are receiving a signal from cable TV or an off-air antenna. When you run Channel Search (see "Channel Search" in this section for details), the HD receiver automatically detects your signal and you don't have to specify it here. However, if you decide to change the source, you will need to use the Signal Type menu. Note that when your signal source is coming from DIRECTV, this menu will not be available.



*Select whether you are receiving signals from an off-air antenna or cable.*

# SYSTEM OPTIONS AND PREFERENCES

## CHANNEL SEARCH

Engaging in a channel search tells the HD receiver to search automatically for all the terrestrial channels available through the antenna inputs. When the HD receiver finds an active channel, it places it in the channel list. Inactive channels (weak stations or channels with no signal at all) will not be placed the channel list.

The Channel Search screen lets you choose to do either a Full Search or a Quick Search. A Full Search searches both Antenna A and B, automatically detects whether you are using cable or an off-air antenna, and may take many minutes. Quick Search searches only for channels on the antenna you're currently using and is completed faster than a Full Search.

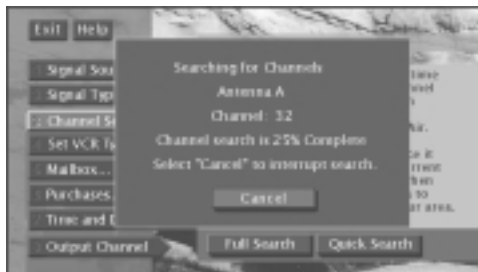

*Running channel search collects all available channels in a channel list.*

You can also edit the channel list and remove unwanted channels by using the Profiles menu.

Another way to add channels is to directly tune to them using the digit buttons on the remote control. If the system can obtain that channel's signal, it will be added into the channel list.

## SET VCR TYPE

In order to use one-touch recording, you need to tell the HD receiver which VCR brand you are using.

1. Press MENU on the remote control to bring up the main menu.
2. Highlight *System Options* and press OK.
3. Highlight *Set VCR Type* and press OK.

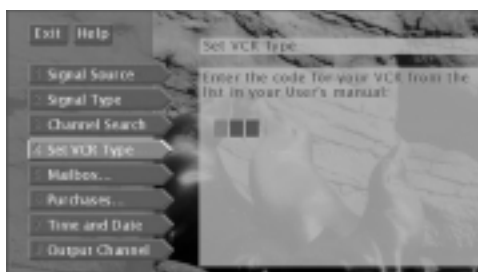

4. Use the arrows or digit buttons to input the correct three-digit code for your VCR brand. The three-digit VCR codes are located in the "Setup and Connections" section of this book.
  5. Follow the on-screen instructions to ensure that you are using the correct code. If the VCR automatically stops, then you know that the HD receiver and the VCR are communicating.
- Note that some VCR brands may not be capable of being controlled by the HD receiver.

# SYSTEM OPTIONS AND PREFERENCES

## MAILBOX

If you have ordered DIRECTV® programming, the mailbox shows you messages that are sent—or “mailed”—from your program providers. For example, you may receive a message calling your attention to a new service or special program offering. If you have new or unread mail, the mail icon in the channel banner is highlighted.

## CHECKING YOUR MAIL

1. Select *Mailbox* from the Systems Option menu or the mail icon from the channel banner to view your mail.
2. Highlight a message and press OK. The message opens for you to read.
2. Press OK again to close the letter.
3. If you want to erase a message, highlight *Erase Message* and press OK. When you exit the display screen, messages not erased are saved in memory.

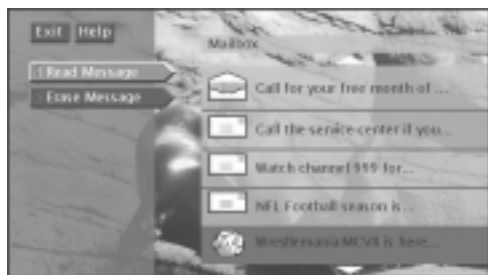

*Mail provides the latest information from program providers.*

# SYSTEM OPTIONS AND PREFERENCES

## PURCHASES: PAY PER VIEW PROGRAMS

Pay Per View programs (PPV) are DIRECTV programs that you purchase—like a movie ticket—if you subscribe to DIRECTV® programming. You can preview movies on certain channels to determine if you would like to purchase them.

You may need to enter your four-digit system password to order a PPV program if it costs more than the spending limit you set up in the Profiles menu.

## PREVIEWING AND PURCHASING

You can preview and purchase DIRECTV Pay Per View movies and events if you subscribe to DIRECTV programming.

### To preview a movie or event:

- When in the DIRECTV program guide, use the down arrow on the remote to move the highlight to the bottom of the screen. Select the *Other Guides* icon and then select *Attractions Guide*. Select a channel.

### To purchase a movie or event, you can take one of two actions:

- Tune to a PPV by channel surfing within DIRECTV channels and finding a PPV channel. When you find it, press the INFO button find more information and details about how to purchase it.
- Highlight a PPV program from the DIRECTV program guide and press INFO. The Program Details screen will appear and give you more information about the program. From this screen you can also purchase the program.



The Other Guides icon

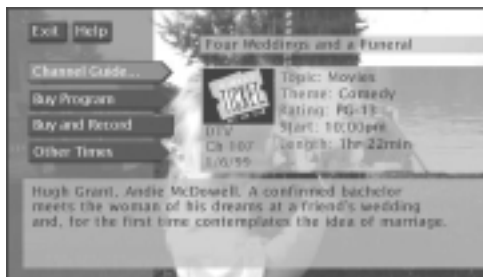

The Program Details screen gives you several options.

From the Program Details screen, you can select:

- *Channel Guide* to see a program lineup for that channel
- *Buy Program* to purchase the program
- *Buy & Record* to purchase the program and set a timer to record it
- *Other Times* to see what other times the program is available

The options available to you may vary according to the type of program you select.

You need to connect your phone line to your television to be able to order PPV programs using the on-screen menus.

# SYSTEM OPTIONS AND PREFERENCES

## USING THE ATTRACTIONS GUIDE

Your program providers may offer future programming events not currently listed in your DIRECTV program guide. These events are called “coming attractions” and can be previewed in the Attractions Guide. To access the Attractions Guide:

1. Press the DIRECTV button on the remote control. Then press GUIDE.
2. Use the down arrow icon to move the highlight to the bottom of the screen.
3. Select the *Other Guides* icon.
4. Select *Attractions Guide*.
5. Select a channel.



*The Other Guides icon*



*The Attractions Guide is accessed through the Other Guides menu.*

## USING THE PURCHASES MENU

The Purchases menu allows you to review upcoming and past DIRECTV Pay Per View purchases and edit spending limits.

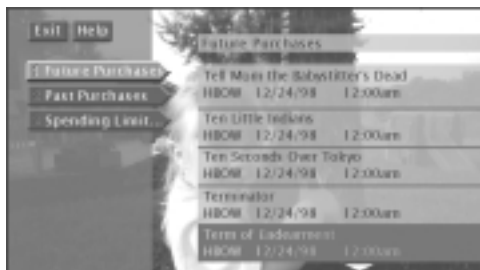

*The Purchases menu shows you upcoming or past DIRECTV purchases and spending limits.*

The list of purchases may be longer than one screen; use the down arrow buttons on the remote control to see more items. The display also shows the title, channel, date, time, and cost of each program.

- Note that the past purchases list might not be updated until the end of the billing cycle, and therefore may show purchases for which you have already paid.

# SYSTEM OPTIONS AND PREFERENCES

## REVIEWING AND CANCELING AN UPCOMING PURCHASE

Highlight an upcoming purchase from the DIRECTV Future Purchases screen. You can review the program description, as well as cancel an upcoming purchase. To cancel, select the program, and then press OK.

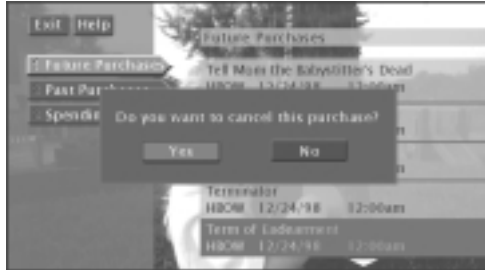

The Future Purchases screen lets you cancel an upcoming purchase.

## SETTING THE TIME AND DATE

You can set the current time and day, the current date, the time zone, and whether or not you observe daylight saving time.

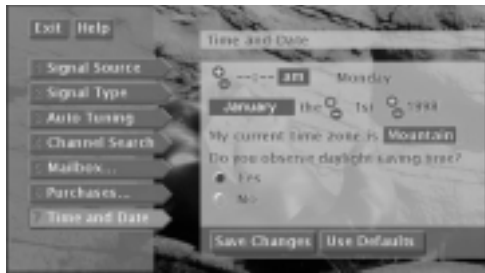

Indicate the settings for your area.

Use the arrow buttons to move around the menu screen, OK to select an item, and the digit buttons on your remote control to enter numbers. If you have already acquired a digital signal, the time was automatically set and you cannot reset it. You can, however, reset the time zone and whether you observe daylight saving time.

Important: After you make changes, be sure to select *Save Changes*. If you do not, your changes will be discarded.

If you select *Use Defaults*, any changes you made will be discarded and the time and date will be reset to the last saved setting.

# SYSTEM OPTIONS AND PREFERENCES

## CHOOSING AN OUTPUT CHANNEL

You can choose which channel to view your HD receiver, either channel 3 or 4. If you select channel 4 and then select “Now” from the pop-up dialog box, be sure to immediately change your TV or monitor to channel 4—otherwise, your screen will be blank.

## USING THE PREFERENCES MENU

The Preferences menu allows you to change some aspects of your HD receiver to fit your personal preference. The following sections outline what you can do in this menu.

### COLOR SCHEME

You can change the color that appears in the menu and guides. To change the color, select *Preferences* from the main menu and select *Color Scheme*.

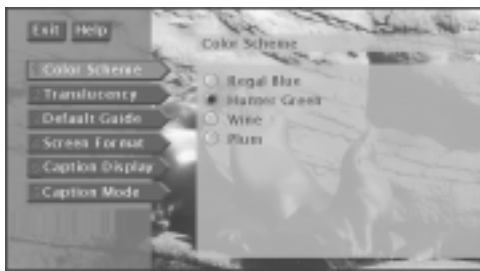

Use the up and down arrows and OK button to select the menu color scheme you prefer.

### TRANSLUCENCY

You can adjust the level of translucency that the menu screens and program guides possess. Adjust the slider up for more translucency (the video behind the menu and guides will be more visible) or down for less translucency (less video will be shown behind the menu or guides).

### DEFAULT GUIDE

By default, the Detail Guide appears when you press GUIDE on the remote control, no matter if you access the DIRECTV® programming guide or the TV program guide. You can change the default guide from the Detail Guide to the Grid Guide or SurfGuide (DIRECTV only). For more information about the three types of guides, see the section, “Using the Program Guides.”

1. Select *Preferences* from the main menu, then select *Default Guide*.
2. Use the arrows and OK to choose which guide you want to appear first when you press the GUIDE button on the remote control.

#### Note

If you choose SurfGuide as the default, the Grid Guide will appear when you access the TV program guide, since the SurfGuide isn't available as a TV program guide.



# SYSTEM OPTIONS AND PREFERENCES

## SCREEN FORMAT

Your selection in the Screen Format menu depends on the type of TV or monitor you are using with your HD receiver.

### With a 4:3 Ratio TV or Monitor

If you are using a 4:3 ratio TV or monitor and receive an image with a 16:9 ratio, you need to specify how the image is displayed.

**Letterbox** Choose this when receiving a 16:9 image and you want to see the original wide format. Letterboxing shrinks the picture so the entire image will fit on the screen. Black panels appear at the top and bottom of the screen.

**Cropped** Choose this when receiving a 16:9 image and you want the wide movie format to fill the entire screen. Left and right portions of the picture is cropped, or cut.

### With a 16:9 ratio TV or Monitor

If you are using a 16:9 ratio TV or monitor and receive an image with a 4:3 aspect ratio, the image will be displayed at the 4:3 ratio on your monitor unless you specify otherwise. The Screen Format menu allows you to adjust the image through the following options:

**Normal** Choose this when receiving a 4:3 image and you want the on-screen appearance of the video to be a centered picture with side panels (blank areas) on the right and left sides.

**Full** Choose this when you want the television to adjust the 4:3 image horizontally so it fills your 16:9 screen. No side panels will be added, and the image is vertically unaltered. This setting is especially useful for viewing 4:3 formatted DVDs.

**Fill** Choose this when receiving a 4:3 image and you do not want side panels on the right and left sides of the screen. The television will adjust the image both horizontally and vertically so it fills the height and width of your 16:9 screen with no side panels added. It will also maintain the correct image proportion. Use with material such as laserdiscs or VCR tapes.

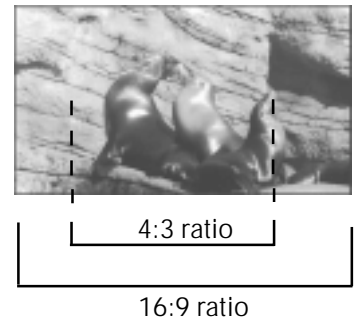

Some digital (ATSC format) stations may transmit 4:3 images in a way that will not allow expansion and you will be unable to adjust the screen format.

## CAPTION DISPLAY

The Caption Display menu displays a choice list that lets you choose when closed captioning information is shown on the screen.

**On Always** Captioning information is shown always, when available.

**On When Muted** Captioning information is only shown when the TV's sound is muted, when available. (To mute the sound, press the MUTE button on the remote control.)

**Off** No captioning information is displayed.

# SYSTEM OPTIONS AND PREFERENCES

## CAPTION MODE

You can also select a closed caption mode, which is the mode, or source, used for displaying captioning information. The content of CC and Text are different; you can select which one you want to see on the screen.

- CC displays information at any position on the screen. It overlays the text on top of the picture as it is received.
- Text displays information at one particular position (such as the bottom third) of the screen. You cannot see the picture underneath the text.

You can choose between eight closed caption modes, or sources:

- **CC1 and Text 1** are the primary caption and text services. The captioning or text is displayed in the same language as the program's dialog.
- **CC3 and Text 3** serve as the preferred data channels. The captioning or text is often a secondary language translation, simplified English, or displayed at a slower rate.
- **CC2 and CC4 and Text 2 and Text 4** are rarely available and broadcasters use them only in special conditions, such as when CC1 and CC3 are not available, or Text1 and Text3 are not available.

## USING FETCH

The Fetch menu is a list of eight convenient menu items. It serves as a shortcut to access these menu items. To view the Fetch menu, press FETCH on the remote control.



*Using FETCH is a convenient way to access frequently used menu items.*

# GETTING ASSISTANCE

## HELP WITH USING THE HD RECEIVER

If you run across any problems or need to rely on the system to give you feedback, you should use the Assistance menu to get information. This section explains the different types of assistance your system is capable of giving you. It walks you through the Assistance menu, which is accessed by pressing MENU then selecting *Assistance*.

This section:

- tells you about the interactive setup process.
- helps you get antenna and dish pointing information.
- explains the on-screen signal meter.
- tells you how to validate a new access card.
- describes how to use the system test.

Most of the screens contain information to help you decide what to do next. If you get stuck, look for the help text at the bottom of the screen. Or, select the Help button on the top of a menu to view more information about your options.

**1** SETUP AND CONNECTIONS



**2** USING THE REMOTE



**3** BASIC OPERATION



**4** USING THE PROGRAM GUIDES



**5** AUDIO CONTROLS AND TIMERS



**6** USING THE PROFILES



**7** SYSTEM OPTIONS AND PREFERENCES



**8** GETTING ASSISTANCE



**9** REFERENCE

# GETTING ASSISTANCE

## RUNNING THE INTERACTIVE SETUP

You should have completed the interactive setup the first time you plugged in your HD receiver. However, if you need to access the interactive setup again, you can access it through the Assistance menu.

1. Press MENU on the remote control to access the main menu.
2. Select *Assistance* from the main menu.
3. Select *Interactive Setup* and follow the on-screen directions.



*The interactive setup process allows you to complete all steps or selectively skip steps.*

The steps involved in the interactive setup include:

- Setting the time and date
- Searching for available channels
- Specifying your satellite dish antenna type
- Finding dish coordinates
- Viewing the signal meter
- Running the system test

Note that if you do not subscribe to DIRECTV® programming, you can select “Skip this step” for finding dish coordinates, running the signal meter, and running the system test.

# GETTING ASSISTANCE

## GETTING ANTENNA INFORMATION

The Antenna Info menu helps you assess the availability of available TV channels. It is useful for checking the strength of digital channels, obtaining all channels possible, and adjusting any terrestrial TV antennas.

- Press MENU to bring up the main menu, select *Assistance*, then *Antenna Info*.

The Antenna Info screen reports the status of the signal search and lists channels that are being received or have been received from all terrestrial antennas. To switch between antennas, highlight a channel and then press ANTENNA on the remote control. When getting antenna information, the screen lists:

- the channel number,
- the station name, if available,
- whether the channel is digital or analog,
- which antenna is receiving the signal, and
- if a digital channel, the current signal strength.

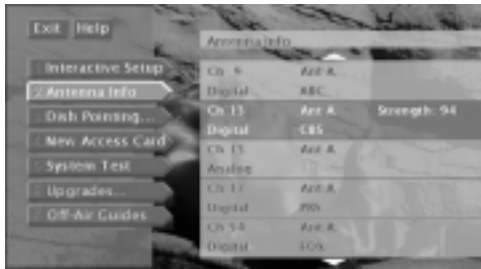

*Antenna Info consists of all channels currently being received or that have been received in the past from terrestrial antennas.*

## SELECTING DISH TYPE

To specify the type of dish you are using:

1. Press MENU on the remote to bring up the main menu.
2. Select *Assistance*, then *Dish Pointing*, then *Select Dish*.
3. Use the arrows and OK buttons on the remote control to select the type of dish you are using—either the oval dish or the round dish.



Note that if you highlight a channel in the Antenna Info menu, you tune to the channel and, if digital, receive a real-time update of the signal strength.

It is important to select the correct dish type. If you do not, you will not receive the proper dish pointing coordinates and you will not be able to take full advantage of your DIRECTV System.

# GETTING ASSISTANCE

## FIND YOUR DISH POINTING COORDINATES

Full instructions for installation are provided with your satellite dish antenna. To obtain your dish pointing coordinates:

1. Press MENU on the remote to bring up the main menu.
2. Select *Assistance* then either *Enter Zip Code* or *Enter Lat/Long*.
3. Enter the appropriate numbers.

*NOTE: The screen that you see may be slightly different from the one pictured here.*

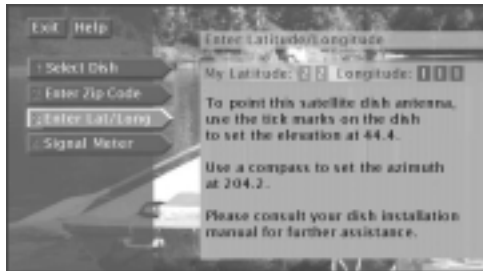

4. Record elevation, azimuth, and polarization (necessary only with an oval dish) numbers below.
5. Follow the installation instructions provided with your satellite dish antenna.

Elevation \_\_\_\_\_ Azimuth \_\_\_\_\_

Tilt (oval dish only) \_\_\_\_\_

## USING THE ON-SCREEN SIGNAL METER

The signal strength meter is used to determine whether you are receiving the DIRECTV signal; it also indicates the strength of the DIRECTV signal once the signal is acquired.

Follow these steps to bring up the on-screen signal meter:

1. Press MENU on the remote to bring up the main menu.
2. Select *Assistance* then *Dish Pointing*.
3. Select *Signal Meter*.



*If the dish is pointed correctly, the signal meter will show you the current signal strength (and you should hear a continuous tone).*

You only need to use one of the available methods to find your dish pointing coordinates. If you know the Zip Code for the dish location, use that.

Elevation is the up/down angle that the dish is pointed.

Azimuth is the side-to-side direction that the dish is pointed.

Tilt is the circular rotation of the dish itself, like a steering wheel.

### Peak Signal

The "Peak Signal" indicates the highest signal strength you have obtained, which is not necessarily the highest possible signal.

While the maximum signal strength is 100, the signal strength you achieve will probably be less. Although there is no difference in picture quality between signal strengths of 60 and 85, the higher the signal, the less likely you are to experience negative effects in degraded conditions such as rain or snow (called "rain fade").

# GETTING ASSISTANCE

4. Use the arrows and OK button on the remote control to highlight and toggle between the satellites (available if you have specified that you have an elliptical, DIRECTV dish). Try to achieve the peak signal for each.

## Important

Changing transponders is not the same as fine-tuning the dish. Although the signal strength may change, this may be due to different transponder power levels.

## YOUR NEW ACCESS CARD

Periodically, your program provider may issue you a replacement access card if you subscribe to DIRECTV® programming. The New Access Card Setup screen allows you to transfer the information from the old card onto the new one. The access card fits into the HD receiver through the back panel.

To replace the card:

1. Select *Assistance* from the main menu.
2. Select *New Access Card*.
3. Follow the on-screen directions to validate the new card.

See the section "Setup and Connections" for details about where to insert your access card.

## RUNNING THE SYSTEM TEST

The System Test display screen is accessed through the Assistance menu and allows you to initiate diagnostic procedures on the DIRECTV System, if you subscribe to DIRECTV® programming.

You should use this feature to get your access card number or when your television doesn't seem to be receiving satellite signals correctly.

A message screen appears when you select *System Test* from the Assistance menu. This message tells you whether the system passed each test. If your system fails the test, run the system test several times before concluding that there is a problem.

Occasional fluctuations in the phone line or satellite signal can give temporary false readings. Note that if you do not subscribe to DIRECTV® programming or do not have your satellite dish antenna installed, the test will fail.

# GETTING ASSISTANCE

## UPGRADES

Language is forthcoming

## OFF-AIR GUIDES

If you are certain your antenna is properly set up and receiving a strong signal, but you are receiving invalid program guide information or are having trouble tuning to a channel, you can disable your system's ability to acquire off-air TV program guides. If you subscribe to DIRECTV® programming, you will still receive DIRECTV programming guides if you do not receive TV program guides.

To disable the TV program guide:

1. Select *Assistance* from the main menu.
2. Select *Off-Air Guides* from the Assistance menu.

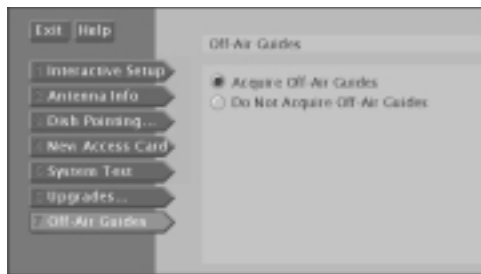

Select *Off-Air Guides* from the Assistance menu.

3. Use the arrows on the remote to highlight *Do Not Acquire Off-Air Guides* and press OK to select it. Then exit from the menu.
4. You should now rebuild the channel list by selecting *System Options* from the main menu and selecting *Channel Search*.



# REFERENCE

## ADDITIONAL INFORMATION

This section contains troubleshooting information, your RCA limited warranty, and accessory ordering information.

**1** SETUP AND CONNECTIONS



**2** USING THE REMOTE



**3** BASIC OPERATION



**4** USING THE PROGRAM GUIDES



**5** AUDIO CONTROLS AND TIMERS



**6** USING THE PROFILES



**7** SYSTEM OPTIONS AND PREFERENCES



**8** GETTING ASSISTANCE



**9** REFERENCE

# REFERENCE

## TROUBLESHOOTING

### Can't select certain channel

- Channel may be blocked or not approved in the Profiles menu.
- If using a VCR, check to make sure the TV/VCR button on the VCR is in the correct "mode."

### Noisy stereo reception

- May be a weak station.

### No picture, no sound but TV is on

- Maybe a vacant channel or input is tuned.
- If watching VCR (connected only through antenna input), make sure TV is tuned to channel 3 or 4 – same as CH3/4 switch on VCR. Also check to make sure the TV/VCR button on the VCR is in the correct "mode."

### Sound okay, picture poor

- Check antenna connections and pointing and also check for interfering sources.

### Wrong picture

The TV and most VCRs let you toggle between pictures: one can be the picture from DIRECTV signal or a terrestrial antenna (or cable) and one can be from the VCR. If you don't see the picture you think you should be seeing, try using these buttons to toggle between the pictures:

- Press the TV/VCR button on the VCR remote or on the VCR's front panel.
- Press the ANTENNA button on the remote control.

Taking either of these actions lets you switch the source of the video signal from DIRECTV to the off-air antenna or cable, and vice versa.

### Problems with the remote control

- Maybe something is between the remote control and the remote sensor on the front of the TV, monitor, or HD receiver.
- Maybe the remote control is not in the correct mode. Press the INPUT button to view either DIRECTV or TV programming. Also try pressing HD RCVR.
- Maybe the batteries in the remote control are weak, dead or installed incorrectly. Try replacing batteries. (Note, if you remove the batteries and do not reinsert them within 30 seconds, you may have to reprogram the remote to control other components.)
- Remove the batteries and hold the number 1 button for at least 60 seconds to drain the microprocessor inside the remote control. Release the button, replace the batteries, and (if necessary) reprogram the remote control.

### Blank screen

- Maybe the component (VCR, DVD, etc.) connected to the input jacks is not on.
- Try another channel, because there may just not be any programming on at that time.
- Maybe the HD receiver output you intended to use is not selected. If you have connected the TV or monitor to the HD receiver using the receiver's HD MONITOR OUT jack, use the front panel to select HD MONITOR. If you are not using the HD MONITOR OUT jack, then this should not be selected.

# REFERENCE

- Due to copyright restrictions, you may not be available to record or view some high definition programs in high definition format using this product. To view this type of programming in standard definition format, you must also connect the Audio/Video jacks to the monitor.

## Problems with your system password

- If you remove your access card from the slot on the back of the HD receiver, your system password will default back to what it was before you entered the access card.
- If you forget your system password and subscribe to DIRECTV® programming, call DIRECTV to obtain a new one.

## HD receiver will not turn on

- Check to make sure it is plugged in.
- Check the wall receptacle (or extension cord) to make sure it is “live” by plugging in something else.
- Maybe batteries in the remote control are “dead.”
- Maybe the remote control is not aimed at the remote sensor.

## Turns off while playing

- The Timers function may have been activated.
- Electronic protection circuit may have been activated because of a power surge. Wait 30 seconds and then turn on again. If this happens frequently, the voltage in your house may be abnormally high or low.

## TV turns on or changes channels unexpectedly

- Scheduled Watch from the Timers menu may have been activated.

## Repair Help

Thomson Consumer Electronics offers a hardware repair service if you encounter any problems with your HD receiver. Many problems can be diagnosed over the phone; if necessary, a replacement unit can be shipped to you. **Please have your model, serial number and date of purchase ready when you call.** If your unit is out of warranty, we will quote the cost of an exchange unit to you. Refer to the limited warranty for the repair service phone number.

### Returning Equipment to Thomson for Repair or Exchange

If we are unable to resolve your problem over the phone we will gladly service your unit or exchange it for a new or refurbished unit. Refer to the limited warranty in this booklet to learn about your specific rights and responsibilities. *Always consult Thomson and get a Return Authorization number before returning anything.* To avoid delays, accounting errors, or even loss of your unit, obtain a Return Authorization (RA) number from the telephone representative before returning your equipment.

### Important Information to Customers Who Ship Defective Equipment to Thomson Consumer Electronics

The Thomson representative who authorizes the return of your equipment will give you an RA number over the phone. The representative will also provide you with instructions on where and how to return your unit. Write the RA number in large, clear characters on the outside of the box. *To avoid confusion and misunderstandings, shipments without an RA number clearly visible on the outside of the box will be returned to you at your expense.*

Include a brief note describing the problem and any conversations you have had with Thomson personnel about the problem. Include your name, address, and the model/serial number of your unit. These numbers are located on the back of your HD receiver. If your HD receiver is within the warranty period, please include a copy of the bill of sale to verify purchase date. Use the original box and packing material to protect the equipment from damage in shipment. **For your protection, insure all shipments for full replacement value and use a reliable shipper.** Thomson assumes no responsibility for warranty shipments from the customer to the factory if not shipped in the manner prescribed by Thomson.

# REFERENCE

## RCA HIGH DEFINITION (HD) DIGITAL RECEIVER LIMITED WARRANTY

### What your warranty covers:

- Any defect in materials or workmanship.

### For how long after your purchase:

- 90 days - Unit exchange, which includes parts and labor.
- 91 days to 1 year - Unit exchange, which includes parts only; you pay the labor.
- The warranty for rental units begins with the first rental or 45 days from date of shipment to the rental firm, whichever comes first.

### What we will do:

During the initial 90 days:

Exchange the defective portion of your Digital Receiver with a new or, at our option, refurbished unit.

After the 90 days and within one year:

Exchange the defective portion of your Digital Receiver with a new or, at our option, refurbished unit. We will charge you a flat exchange cost to replace a defective receiver. This charge covers the labor cost for its repair.

### How you get service:

- Call 1-888-901-HDTV and have your unit's date of purchase and model/serial number ready. The model/serial number information is on the back of your receiver.
- A representative will troubleshoot your problem over the phone.
- If the representative determines that you should receive a replacement receiver you will be provided with a Return Authorization (RA) number and the location of a nearby exchange point if one exists. No returns will be accepted without the RA number.
- If the representative determines that your antenna/dish is defective they will arrange for its repair or replacement.

### Option I:

1. Provide your Discover, MasterCard or Visa account number and expiration date to your phone representative. This is for security purposes only and your account will not be charged at this time.
2. We will send you a replacement unit.
3. If you return the unit to us within 14 days from the date you were provided a RA number, only items not covered by warranty will be charged to your account. If your unit is not received within 14 days, the suggested retail value of the receiver will be charged to your credit card. This amount will be credited, less a \$10 handling fee, if the unit is subsequently received.
4. Ship your defective unit back to us using the replacement unit's carton. Shipping instructions will be included on the carton along with your RA number which will allow you to easily ship the unit back to us. Make sure you insure your shipment in case of damage or loss. Include with the shipment:

# REFERENCE

- Evidence of purchase date such as a bill of sale.
- A brief note describing your receiver's problem.
- Your name, address and phone number.

## **Option II:**

1. We will send a replacement unit to our exchange point.
2. The exchange location will notify you of its arrival.
3. Take your unit and evidence of purchase date, such as a bill of sale, to the exchange location and you will be provided the new or refurbished unit. Please retain all accessories such as the remote control hand unit.
4. If the repairs are covered by your warranty, you will not be billed.

Thomson assumes no responsibility for warranty shipments from the customer to the factory if not shipped in the manner prescribed by Thomson.

## **To receive a replacement receiver after we have received your unit:**

- Write the RA number on the outside of the carton used to return the unit. Make sure you insure your shipment in case of damage or loss.
- Carefully pack the unit using the original box and packing material if possible. Please retain all accessories that were included with your unit such as the remote control hand unit.
- Include with the shipment: Evidence of purchase date such as a bill of sale, a brief note describing your receiver 's problem, your name, address and phone number.
- The representative will advise the address to mail a cashier's check or money order for payment if there are any out of warranty labor or parts charges, and you elect not to use your credit card.
- After we receive your product, a new or refurbished unit will be shipped to you.

## **What your warranty *does not* cover:**

- Acts of God, such as but not limited to lightning damage.
- Adjustment of customer controls.
- Damage from misuse or neglect.
- A unit that has been modified or incorporated into other products or is used for institutional or other commercial purposes.
- Batteries.
- Units purchased, serviced or operated outside the continental U.S.A. and Alaska.
- For units intended for use in Alaska, this warranty does not cover installation or the dish antenna. It only covers the Digital Receiver.
- Loss of programming.
- Installation.
- Shipping damage if the unit was not packed and shipped in the manner prescribed by Thomson.
- Storage fees may be charged by the exchange point if you fail to pick up the replacement unit in a timely manner.

# REFERENCE

## **Product Registration:**

Please complete and mail the Product Registration Card packed with your Digital Receiver. It will make it easier to contact you should it ever be necessary. The return of the card is not required for a warranty coverage.

## **How state law relates to warranty:**

This warranty gives you specific legal rights and you may have other rights that vary from state to state.

## **If you purchased your product outside the United States:**

- This warranty does not apply. See your dealer for warranty information.

## **FCC REGISTRATION INFORMATION**

Your equipment is registered with the Federal Communications Commission and is in compliance with parts 15B and 68, FCC Rules and Regulations.

### **1. Notification to the Local Telephone Company.**

On the back of this equipment is a label indicating among other information, the FCC Registration number and Ringer Equivalence Number (REN) for the equipment. You must, upon request, provide this information to your telephone company. The REN is useful to determine the number of devices you may connect to your telephone line and still have all these devices ring when your telephone number is called. In most (but not all) areas, the sum of the RENs of all devices connected to one line should not exceed 5. To be certain of the number of devices you may connect to your line as determined by the REN, you should contact your local telephone company.

Note: This equipment may not be used on coin service provided by the telephone company. Party lines are subject to state tariffs, and therefore you may not be able to use your own telephone equipment if you are on a party line. Check with your local telephone company. Notice must be given to the telephone company upon permanent disconnection of your equipment from your line.

### **2. Rights of the Telephone Company.**

Should your equipment cause trouble on your line which may harm the telephone network, the telephone company shall, where practicable, notify you that temporary discontinuance of service may be required. Where prior notice is not practicable and the circumstances warrant such action, the telephone company may temporarily discontinue service immediately. In case of such temporary discontinuance, the telephone company must: (1) promptly notify you of such temporary discontinuance (2) afford you the opportunity to correct the situation and (3) inform you of your right to bring a complaint to the Commission pursuant to procedures set forth in Subpart E of Part 68, FCC Rules and Regulations. The telephone company may make changes in its communications facilities, equipment, operations or procedures where such action is required in the operation of its business and not inconsistent with FCC Rules and Regulations. If these changes are expected to affect the use or performance of your telephone equipment, the telephone company must give you adequate notice, in writing, to allow you to maintain uninterrupted service.

# REFERENCE

## Radio Interference

This equipment has been type tested and found to comply with the limits for a Class B Digital Device in accordance with the specifications in Part 15 of FCC Rules. These rules are designed to provide reasonable protection against radio and television interference in a residential installation. This equipment generates, uses, and can radiate radio frequency energy and, if not installed and used in accordance with the instructions, may cause harmful interference to radio communications. However, there is no guarantee that interference will not occur in a particular installation.

If this equipment does cause interference to radio or television reception (which you can determine by turning the equipment off and on), try to correct the interference by one or more of the following measures:

- Reorient or relocate the receiving antenna (that is, the antenna for radio or television that is "receiving" the interference).
- Change the position of the receiver with respect to the radio or television equipment that is receiving interference.
- Move the receiver away from equipment receiving interference.
- Plug the receiver into a different wall outlet so the receiver and equipment receiving interference are on different branch circuits.

If these measures do not eliminate interference, please consult your dealer or an experienced radio/television technician for additional suggestions. Also, the Federal Communications Commission has prepared a helpful booklet, "How To Identify and Resolve Radio/TV Interference Problems." This booklet is available from the U.S. Government Printing Office, Washington, D.C. 20402. Please specify stock number 004-000-00345-4 when ordering copies.

# REFERENCE

## ACCESSORY INFORMATION

The following accessories are available from most dealers and electronics supply stores in case you want to position your components farther apart or need additional cables.



**Standard Audio/Video cable** with RCA-type phono plugs. VH83

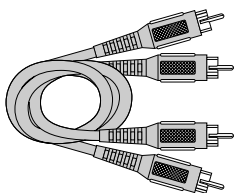

**Monaural VCR Dubbing Audio/Video Cable** is a double cable that lets you connect the video and audio jacks of two VHS VCRs to duplicate tapes. It can also be used to connect a VCR to your TV. The cable is color-coded and shielded. It has RCA-type phono plugs on each end. Gold-Tipped cable, VH83 (6-ft)

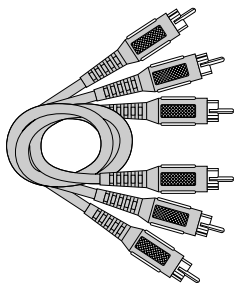

**Stereo VCR Dubbing Audio/Video Cable** is a triple cable that lets you connect the VIDEO and AUDIO jacks of stereo components. Gold-Tipped cable, VH84 (6-ft)

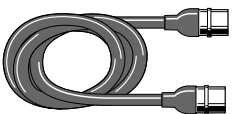

**Push-on Cable\*** attaches to the round antenna connectors (called 75-ohm F-type) on the back of your VCR or TV. The ends push on for a quick connection. VH89 (6-ft)

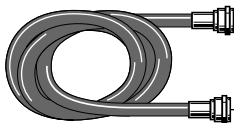

**Screw-on Cable\*** attaches to the round antenna connectors (called 75-ohm F-type) on the back of your VCR or TV. The ends screw onto the connectors for a secure connection. VH82 (6-ft), VH81 (3-ft)

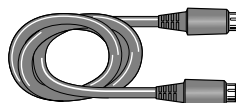

**S-Video Cable** has multi-pin connectors on each end for connecting S-Video components to your TV. VH976 (6-ft), VH913 (12-ft)

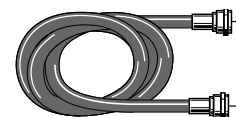

**RG-6 Coaxial Burial Cable** with weatherproof "F" connectors. D905

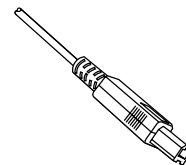

**Optical/SPDIF cables** help you connect to a component with an Optical Audio In jack, such as a Dolby Digital decoder or receiver. DV3 (3-ft), DV6 (6-ft)

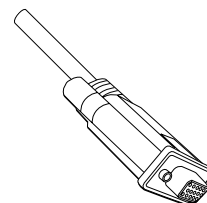

**VGA Cable** attaches to the HD MONITOR OUT jack on the back of the HD receiver for connection to compatible monitors. PC3340 (6-ft)



# REFERENCE

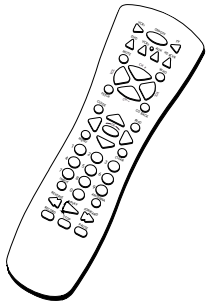

CRK76CA2

**Remote Control** This is the remote control that came packed with your HD receiver. Replacements or spares can be ordered as needed.

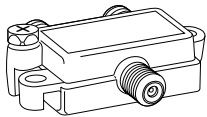

2-way Splitter (VH47)  
4-way Splitter (VH49)

**2-way Signal Splitter, 4-way Signal Splitter\*** helps you connect to other components.



ANT200

**Amplified VHF/UHF/FM Antenna** allows you to easily switch from the antenna signal to cable or satellite easily without disconnecting antenna.

\* This accessory is intended for use with an off-air or cable TV signal distribution and is not suitable for distribution of the satellite signal originating from your satellite dish antenna.

## Accessory Order Form

Description	Part No.	Price	Qty
Screw-on antenna cable* (3-ft)	VH81	\$3.99	
Screw-on antenna cable* (6-ft)	VH82	\$5.45	
Push-on antenna cable* (6-ft)	VH89	\$5.95	
Weatherproof "F" Connector (2)	D905	\$5.95	
Monoaural VCR Dubbing Cable (6-ft)	VH83	\$5.95	
Stereo VCR Dubbing Cable (6-ft)	VH84	\$8.95	
S-Video Cable (6-ft)	VH976	\$7.95	
S-Video Cable (12-ft)	VH913	\$8.95	
2-way Signal Splitter*	VH47	\$3.95	
4-way Signal Splitter*	VH49	\$6.95	
Amplified Antenna	ANT200	\$44.95	
Antenna Mixer	193984	\$11.15	
Remote Control (CRK76CA2)	240895	\$29.20	
Optical/SPDIF Cable (3-ft)	DV3	\$15.95	
Optical/SPDIF Cable (6-ft)	DV6	\$19.95	
Audio•Video Adapter	228449	\$4.45	
Diplexer	D920	\$19.95	
VGA Cable	PC3340	\$29.95	

Total Merchandise .....	\$
Sales Tax .....	\$
We are required by law to collect the appropriate sales tax for each individual state, country, and locality to which the merchandise is being sent.	
Shipping and Handling .....	\$ 5.00
Total Amount Enclosed .....	\$
Use VISA, MasterCard, or Discover Card preferably. Money order or check must be in U.S. currency only. No COD or CASH.	



Detach Here

Prices are subject to change without notice.  
All accessories are subject to availability.  
Where applicable, we will ship a superseding model.

Please complete other side also

# REFERENCE

Charge your order on your VISA,  
MasterCard, or Discover Card by  
filling in below

## USE YOUR CREDIT CARD

**IMPORTANT:** Copy complete account number  
from your VISA card



□	□	□	□	□	□	□	□	□	□	□	□	□	□	□	□
---	---	---	---	---	---	---	---	---	---	---	---	---	---	---	---

My card expires: □□ □□

**IMPORTANT:** Copy complete account number  
from your MasterCard



□	□	□	□	□	□	□	□	□	□	□	□	□	□	□	□
---	---	---	---	---	---	---	---	---	---	---	---	---	---	---	---

Copy Number above your name on MasterCard: □□□□ My card expires: □□ □□

**IMPORTANT:** Copy complete account number  
from your Discover Card



□	□	□	□	□	□	□	□	□	□	□	□	□	□	□	□
---	---	---	---	---	---	---	---	---	---	---	---	---	---	---	---

My card expires: □□ □□

AUTHORIZED SIGNATURE

(Credit card order will not be processed without signature)

Print or type your name and address clearly.



A complete and correct order will save you days of waiting.

Name: \_\_\_\_\_

Street: \_\_\_\_\_

\_\_\_\_\_ Apt: \_\_\_\_\_

City: \_\_\_\_\_

State: \_\_\_\_\_ Zip: \_\_\_\_\_

Daytime Phone Number: \_\_\_\_\_

Please make sure that both sides of this form have been filled out completely.

- Allow 4 weeks for delivery.
- All accessories are subject to availability.
- Prices are subject to change

## Placing an Order

To place your order by phone, have your Visa, MasterCard or Discover Card ready and call the toll-free number listed below between 8AM and 8PM (EST) Monday through Friday or between 9AM and 5PM (EST) Saturday.

Use this number only to place an order for accessory items listed on this order form.

**1-800-338-0376**

To place your order by mail, detach and mail the completed order form with credit card information, money order or check in US currency (made payable to Thomson Consumer Electronics, Inc.) to the following address:

**Video Accessories  
PO Box 8419  
Ronks, PA 17573**

# REFERENCE

NOTES

# REFERENCE

## INDEX

### A

- A-Z icon 34, 40
- Access card 9, 77
  - Number 20
  - Slot on the receiver 9
- Accessories 86
- Age-based ratings 54
  - Blocking 56
  - Viewing 56
- All icon 40
- AlphaSort icon 34
- Analog signals 4
- Anatomy of the TV program guide 33
- Antenna
  - A 64
  - ANTENNA IN jacks 9
  - B 64
  - Button on the front panel 8
  - Information 75
  - Receiving signals 75
- AphaSort 40
- Arrows on remote 23
- Assistance menu 73
- ATSC 4
- Attractions guide 68
- Audio
  - Audio/Video jacks, cable 7
  - Language 46
  - Quality controls 44
- AUDIO (R and L) jacks 9
- Audio language icon 28
- AUX button 22
- Available channels 65

### B

- Back of the TV 9
- Batteries 17, 80
- Binocular icon 28
- Blocking
  - Age-based ratings 56
  - Content themes 57
- Buy programs 67

### C

- Cables 9
  - Jacks 7
- Canceling purchases 69

### Caption

- Display 71
  - Mode 72
- ### Changing
- Channels 29, 30
  - From the TV guide to the DIRECTV guide 32
- ### Channel
- Groups 37
  - Lists 37
    - Delete channels 51, 53
    - Retrieving channel number 75
    - Search 65, 75
    - Strength 75
    - Up and down 22
  - CLEAR button 23
  - Closed caption 71
  - Color
    - Scheme 70
  - Connections
    - To the back panel 6
    - VCR Controller 18
  - Content themes 54
    - Blocking 57
    - Viewing 57

### D

- Date and time 69
- Default guide 36, 70
- Detail guide 36
- DIGITAL AUDIO OUT jack 9, 15
- Digital signals 4
- DIRECTV
  - Button 17
  - Channel list 50
  - Rating limit 52
  - Setup 50
  - Signal 76
  - Spending limit 51
- Dish pointing 76
- Dish type 75
- Dolby
  - Digital 44
  - Receiver 7, 15
- DVD button 22

### E

- Editing
  - Channels 50
  - Profiles 50

### Exiting

- Program guides 38

### F

- FCC information 84
- Fetch
  - Button 22
  - Using 72
- Fine-tuning the dish 77
- FORWARD button 23
- Front
  - Of the HD receiver 8

### G

- Getting around in the guides 35
- GO BACK button 23
- Grid guide 36
- Guide
  - Button on the remote 23, 33, 34, 36
  - Data 37
  - DIRECTV 34
  - TV 33

### H

- HD MONITOR OUT
  - Button on the front panel 8
  - Jack 9, 80
- Help 42
- High definition 4

### I

- Icons 28, 34, 40, 47, 62
- INFO
  - Button on front panel 8
  - Button on the remote 23, 35
- Infrared remote sensor 18
- INPUT
  - Button on the front panel 8
  - Button on the remote 23
- Interactive setup 17, 74

### J

- Jacks 9
  - And cables 7

# REFERENCE

## INDEX

### L

- Language 46
- LED light 22
- Listing all DIRECTV programs 40
- Lock icon 62
- Locking
  - The system 28, 52, 58, 62

### M

- Mail icon 66
- Mailbox
  - Checking your mail 66
  - Deleting mail 66
  - Icon 28
- Maximum signal strength 77
- MENU button 8, 23
- Menu system
  - Icons 47
  - Timers 47
- Menus
  - Icons 62
  - Profiles 50
- Movie
  - Ratings 58
    - Blocking 57, 58
    - Viewing 59
  - Themes icon 39
- Mute 22

### N

- Naming profiles 50
- New access card 77
- Not rated
  - Movies 59
  - Programs 54
- NTSC 4
- Number buttons on the remote 35

### O

- Off-Air Guides 78
- OK button 23
- ON button on front panel 8
- ON•OFF button on remote 22
- On-screen signal meter 76
- Optical
  - Jacks and cables 7

### Other guides

- Attractions guide 68
- Icon 37
- OUT TO TV jack 9
- Output channel 70
- Overheated components 6

### P

- Parent-approved programs 54
- Password
  - System 61
  - User 61
- PAUSE button 23
- Pay Per View program 52
- Phone
  - Jack 7, 9
  - Line 7
- Picture
  - Quality 77
- PLAY button 23
- Positioning cables 6
- Preferences menu 70
- Profiles
  - Choosing 60
  - Locking
    - Unlocking 61
  - Menu 50
  - Unlocking 60
- Program guides
  - Default guide 70
  - Detail guide 36
  - DIRECTV 32
  - Down arrow 42
  - Exiting 38
  - Grid guide 36
  - Help 42
  - Scrolling 35
  - SurfGuide 36
  - Tuning to a program 35
  - TV 32

### Programming the remote to control components 24

- Purchases
  - Cancelling 69
  - Menu 68
  - Pay Per View programs 67
  - Previewing 67
  - Reviewing 69

### R

- Radio interference 85
- Rain fade 77
- Rating limit 52
- RCA-type cables 7
- RECORD button 23, 48
- Recording
  - Selecting VCR Type 19, 20
  - With timers 47
- Remote control 80
  - Buttons 22
  - Programming 24
- Remote control sensor 18
- REVERSE button 23
- Reviewing purchases 69
- RF jacks
  - Cables 7

### S

- S-VIDEO jacks 7, 9
- SAP 46
- Satellite
  - In jack 9
- Satellite dish antenna 75
- Scout 28
  - Icon 41
- Screen format 17, 71
- Scrolling 35
- Search for channels 65
- Set
  - Movie ratings 58
  - Rating limit 52
  - Time and date 69
- Set VCR type 19
- Signal
  - Meter 76
    - Peak Signal 77
  - Source
    - Changing 64
    - Strength 76
      - Of a digital signal 75
    - Type
      - Changing 64
- Sorting
  - The DIRECTV guide
    - Alphabetically 40
    - By movies 39
    - By sports 40
    - By title 34

# REFERENCE

## INDEX

- By topics 39
- Using sports icon 40
- Using topics icon 38
- Sorting by
  - Scout button 41
- Spending limit 51
- Sports
  - Icon 40
  - Themes icon 40
- Station name
  - Retrieving 75
- STOP button 23
- Subchannel number 33
- SurfGuide 36
- System
  - Lock 57, 58, 62
  - Password 62
  - Test 77
  - Unlock 62
- T**
- Telephone jack and cord 7
- Terrestrial antennas 4, 75
- Text
  - Closed caption 72
- Time
  - Icons 47
- Time and date 69
- Timer feature
  - Editing or cancelling 47
  - Menu 47
  - Setting up 47, 48
- Translucency 70
- Transponders 77
- Troubleshooting 80
- Tuning to a program 35
- TV
  - Button 22
  - Channel list 53
  - Program guide 33
  - Rating limit 54
  - Setup 53

- U**
- Unlocking
  - Profiles 60
  - The system 28, 62
- Unrated
  - Movies 59
  - Programs and shows 54
  - Shows 59

- V**
- V-Chip
  - Age-based ratings 54
  - Content themes 54
- VCR
  - CONTROL jack 9
  - Controller 7
  - Type 19, 65
  - VCR1 button 22
  - VCR2 button 22
  - Watching 16
- VIDEO jacks 9
- Viewing
  - Age-based ratings 56
  - Content themes 57
  - DIRECTV programming 34
  - TV programs 33
- Visually impaired 46
- Volume
  - Button 22

- W**
- Warranty 82
- Weak reception 80
- WHO button on the remote 60



Please do not send any products to the Indianapolis address listed in this manual or on the carton. This will only add delays in service for your product.

 **THOMSON CONSUMER ELECTRONICS**

10330 North Meridian Street  
Indianapolis, IN 46290

©1999 Thomson Consumer Electronics, Inc.  
Trademark(s)<sup>®</sup> Registered  
Marca(s) Registrada(s)  
DIRECTV is a trademark of DIRECTV, Inc., a unit of  
Hughes Electronics Corp., and is used with permission.  
Printed in USA  
TOCOM 15407990

The following materials were used in  
printing this publication:



20%

RECYCLED PAPER

MINIMUM 20% POST CONSUMER

