

Video Monitor

WV-BM500/WV-BM503

Operating Instructions



Panasonic®

Before attempting to connect or operate this product,
please read these instructions completely.

**CAUTION**RISK OF ELECTRIC SHOCK
DO NOT OPEN

CAUTION:
TO REDUCE THE RISK OF ELECTRIC SHOCK, DO NOT REMOVE COVER (OR BACK). NO USER SERVICEABLE PARTS INSIDE.
REFER SERVICING TO QUALIFIED SERVICE PERSONNEL.



SA 1965

The lightning flash with arrowhead symbol, within an equilateral triangle, is intended to alert the user to the presence of uninsulated "dangerous voltage" within the product's enclosure that may be of sufficient magnitude to constitute a risk of electric shock to persons.



SA 1966

The exclamation point within an equilateral triangle is intended to alert the user to the presence of important operating and maintenance (servicing) instructions in the literature accompanying the appliance.

WARNING:

TO PREVENT FIRE OR SHOCK HAZARD, DO NOT EXPOSE THIS APPLIANCE TO RAIN OR MOISTURE.

For U.S.A.

Warning:

This equipment generates and uses radio frequency energy and if not installed and used properly, i.e., in strict accordance with the instruction manual, may cause harmful interference to radio communications. It has been tested and found to comply with the limits for a Class A computing device pursuant to Subpart J of Part 15 of FCC Rules, which are designed to provide reasonable protection against such interference when operated in a commercial environment.

For CANADA

This digital apparatus does not exceed the Class A limits for radio noise emissions from digital apparatus set out in the Radio Interference Regulations of the Canadian Department of Communications.

The serial number of this product may be found on the bottom of the unit.

You should note the serial number of this unit in the space provided and retain this book as a permanent record of your purchase to aid identification in the event of theft.

Model No. _____

Serial No. _____

CONTENTS

PREFACE	2
FEATURES	2
PRECAUTIONS	2
MAJOR OPERATING CONTROLS AND THEIR FUNCTIONS	3
OPERATING PROCEDURE	6
INSTALLATION	7
CONNECTIONS	8
SYSTEM CONNECTIONS	9
SPECIFICATIONS	10
STANDARD ACCESSORIES	11

PREFACE

- The Panasonic WV-BM500 is a desk-top closed circuit Video Monitor especially designed for surveillance and studio applications. WV-BM500 features a 5" screen (measured diagonally) and produces sharp, black-and-white pictures with horizontal resolution of more than 700 lines at center. Front mounted controls permit fast picture adjustment. Standard BNC-type input and output connectors enables WV-BM500 to be used with other CCTV monitors or Panasonic Video Tape Recorder.
- Model WV-BM503 is a triple monitor combination with rack-mount chassis that fits the EIA standard 19" rack.

FEATURES

WV-BM500 / WV-BM503

- 5" screen (measured diagonally).
- Horizontal resolution 700 lines at center.
- Short H. AFC time constant for VTR playback.
- Bridging input and output connectors for video and composite sync.
- Available as individual desk top monitor WV-BM500, or triple rack mount version WV-BM503.
- DC restoration.
- Internal and External Sync mode.

PRECAUTIONS

- This unit is designed for indoor use. Operable ambient temperature range must not range beyond 14°F~122°F(—10°C~+50°C), and permissible humidity is less than 90%. Avoid using the monitor under direction sunlight.
- The input power source must be 120V AC 60 Hz .
- Do not block the ventilation slots on the rear panel and side cover.
- When mounting the Model WV-BM503 in an EIA standard 19" rack, be careful to insure that the interior temperature of the rack does not exceed 122°F (+50°C).

MAJOR OPERATING CONTROLS AND THEIR FUNCTIONS

WV-BM500

<Front View>

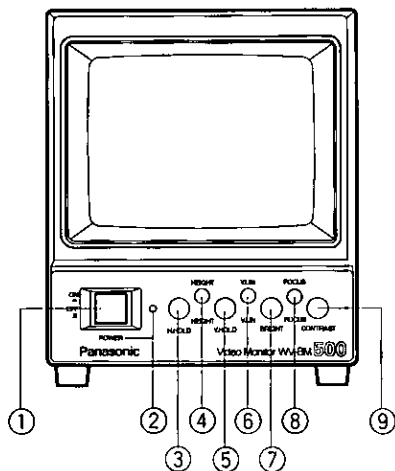

<Rear View>

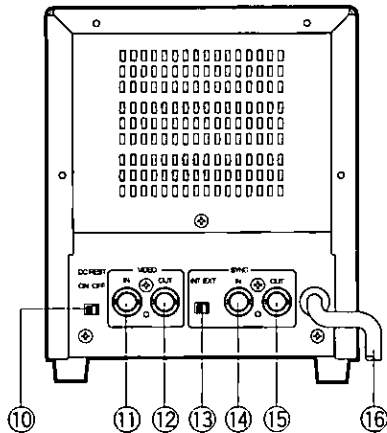

1. POWER ON/OFF SWITCH (POWER, ON/OFF)

This is a push-push type switch which turns the power of this monitor on and off.

Press once and the switch remains down (—) for turning on the power of monitor:

Press again, the switch comes up (—) for turning off the power of the monitor.

2. POWER INDICATOR (POWER)

By turning on the Power On/Off Switch (1), this indicator lights.

3. HORIZONTAL HOLD [H-HOLD]

This control is used to Lock in the picture horizontally.

4. HEIGHT [HEIGHT]

Adjust the vertical height of the picture.

5. VERTICAL HOLD [V-HOLD]

This control is used to Lock in the picture vertically.

6. Vertical Linearity [V-LIN]

Adjust for vertical distortion of the picture.

7. BRIGHTNESS CONTROL [BRIGHT]

Turn this control clockwise to increase the overall brightness.

8. FOCUS [FOCUS]

Adjust for the clearest picture.

9. CONTRAST CONTROL [CONTRAST]

Turn this control clockwise to increase the picture contrast .

10. DC RESTORATION SWITCH [DC REST]

Switch to restore background of picture.

11. VIDEO INPUT CONNECTOR (VIDEO IN)

This connector accepts the input video signal

12. VIDEO OUTPUT CONNECTOR (VIDEO OUT)

The video input signal connected to the Video Input Connector (11) is looped through to this connector and terminated automatically.

13. SYNC SELECTOR SWITCH [SYNC INT/EXT]

14. SYNC INPUT CONNECTOR [SYNC IN]

15. SYNC OUTPUT CONNECTOR [SYNC OUT]

16. AC POWER CORD

WV-BM503

<Front View>

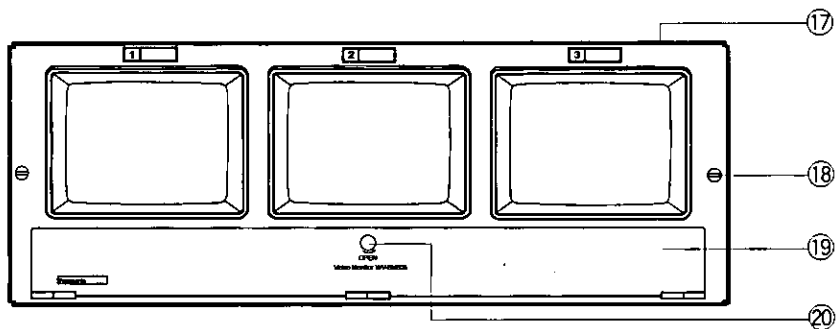

<Rear View>

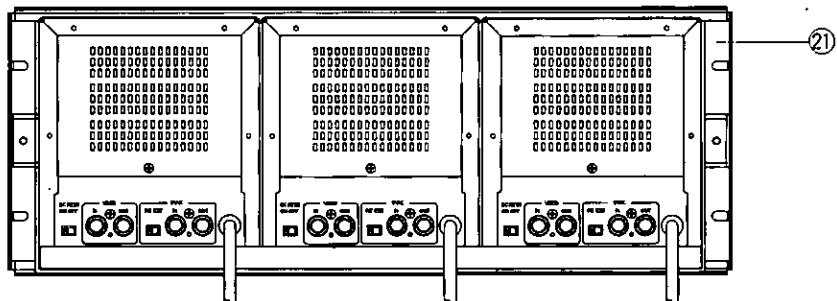

- Model WV-BM503 combines three WV-BM500 video monitors.

- 17. RACK PANEL (WV-BM503)
- 18. FIXING SCREW for RACK PANEL (WV-BM503)
- 19. OPERATION COVER (WV -BM503)
- 20. PANEL KNOB and SCREW (WV-BM503)
- 21. RACK-MOUNT CHASSIS (WV-BM503)

OPERATING PROCEDURE

1. Set the Power On/Off Switch (1) to the ON (—) position.
2. Adjust the Brightness Control (7) and Contrast Control (9).



3. Adjust the Horizontal Hold (3) until the picture is stabilized, if the picture slips to either side, or appears as a series of horizontal stripes.



4. Adjust the Vertical Hold (5), if the picture rolls up or down.



5. Height (4)

This recessed screwdriver control should be adjusted simultaneously to give proper vertical height consistent with good vertical linearity. Adjustment should be made to extend the picture limits approximately 1/10" beyond the top and bottom edges of the mask at over scanning operation.

6. Vertical Linearity (6)

This recessed screwdriver control should be adjusted to give proper vertical linearity.

7. Focus (8)

The clearest picture is produced when this screwdriver control is adjusted.

8. DC Restoration (10)

DC restoration circuit provides a stable reference for the black level. Set the switch to ON position to prevent excessive contrast and preserve shadow detail.

INSTALLATION

CAUTION:

The following installation should be made by qualified service personnel or system installers.

Mounting into EIA Standard 19" Rack

Model WV-BM503 can be mounted into EIA 19" rack as shown below.

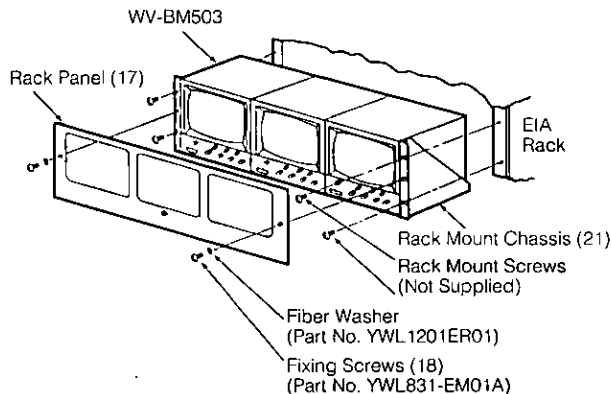

CONNECTIONS

Power Cable

1. Keep the camera Power switched OFF during installation.
2. Connect the Power Cord (16) to a 60 Hz grounded electrical outlet 120V AC.

Video Cable

1. Use the RG-59/U (3C-2V), RG-6/U (5C-2V), RG-11/U (7C-2V) or RG-15/U (10C-2V) coaxial cable.
2. Up to 10 monitors can be hooked up in this configuration before signal loss occurs. Total cable length should not exceed 500 feet (150m).
3. Wiring Precautions
 - Do not bend coaxial cable into a curve whose radius is smaller than 10 times of its diameter.
 - Never crush or pinch the cableAll these will change the impedance of the cable and cause poor picture quality

Recommended maximum cable length

Cable		RG-59/U (3C-2V)	RG-6U (5C-2V)	RG-11/U (7C-2V)	RG-15/U (10C-2V)
Recommended maximum cable length	(ft)	1650	2475	3300	4125
	(m)	500	750	1000	1250

External Sync

When a non-composite video signal is connected to the monitor, it will be necessary to connect an external composite sync signal to the monitor.

1. Connect the Sync Input Connector (14) on the video monitor to the sync signal source by means of a 75 Ω coaxial cable.
2. Set the Sync Selector Switch (13) at EXT position.

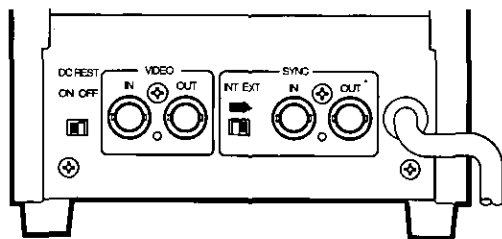

NOTE:

1. Non-composite video signal is a signal without sync.
2. External sync should be composed of mixed H. Sync and V. sync signals, not H. and V. drive pulse signals. Composite Sync Level:
4.0 Vp-p (2.0 Vp-p – 5.0 Vp-p)

SYSTEM CONNECTION

1. Single Monitor Connection

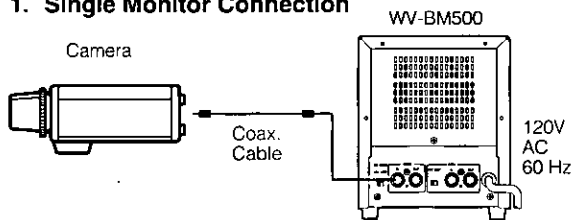

2. Multiple Monitor Connection

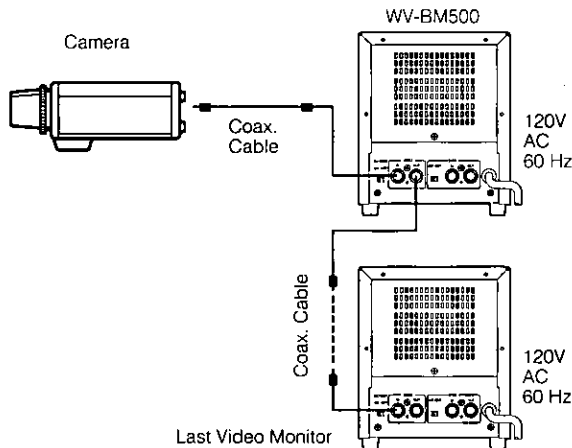

Internal Sync Connection

- Connect the Video Input Connector (11) on the monitor to the Video Out Terminal of cameras with 75-ohm coaxial cables.

External Sync Connection

- When a non-composite video signal is connected to the video monitor, it must also have an external composite SYNC signal connected to the video monitor.
- Set the Sync Selector Switch (13) at EXT position.
- Loop through connection of sync signal is the same as the case of Video Signal.

SPECIFICATIONS

Power Source :	120V AC60Hz
Power Consumption :	WV-BM500 Approx. 14W, WV-BM503 Approx. 42W
Tube Size :	5" diagonal actual visual size (5.5" diagonal tube screen size)
Video Input Impedance :	75 Ω or high impedance (Auto Termination)
Video Input Level :	1.0 Vp-p composite (0.5 Vp-p - 2.0 Vp-p)
Resolution :	More than 700 lines (Horizontal at center)
Scanning Frequency :	Horizontal : 15.75k Hz Vertical : 60Hz
Sweep Linearity :	Horizontal : Less than 5% Vertical : Less than 5%
External Sync Input Impedance :	75 Ω or high impedance (Auto Termination)
External Sync Input Level :	4.0 Vp-p negative (2.0 Vp-p - 5.0 Vp-p)
Operating Ambient Temperature :	14°F - 122°F (-10°C - +50°C)
Operating Ambient Humidity :	Less than 90 %
Dimensions :	WV-BM500: Approx. 5-13/16" (W) x 7-1/16" (H) x 9-5/8" (D) [147 (W) x 180 (H) x 245 (D) mm] WV-BM503: Approx. 19" (W) x 7"(H) x 10-1/16" (D) [480 (W) x 177 (H) x 256 (D) mm]
Weight :	WV-BM500: Approx. 5.1 lbs [2.3 kg] WV-BM503: Approx. 19.8 lbs [9 kg]

Weight and dimension indicated above are approximate.
Specifications are subject to change without notice.

STANDARD ACCESSORIES (Supplied)

WV-BM503

- Fixing Screws for Rack Panel 2 pcs.
(Part No. : YWL831-EM01A)
- Fiber Washers 2 pcs.
(Part No. : YWL1201ER01)

Panasonic

Broadcast & Television Systems Company

Division of Matsushita Electric Corporation of America

CLOSED CIRCUIT VIDEO EQUIPMENT DIVISION

Executive Office: One Panasonic Way, Secaucus, New Jersey 07094

Regional Offices:

Northeast: 43 Hartz Way, Secaucus, NJ 07094 (201) 348-7303

Southeast: 1854 Shackleford Court, Suite 115, Norcross, CA 30003 (404) 717-6835

Midwest: 1707 North Randall Road, Elgin, IL 60123 (708) 468-5200

Southwest: 4500 Amon Carter Blvd., Ft. Worth, TX 76155 (817) 685-1117

Western: 6550 Katella Ave., Cypress, CA 90630 (714) 373-7265

MATSUSHITA ELECTRIC OF CANADA LIMITED

5770 Ambler Drive, Mississauga, Ontario, L4W 2T3 Canada (905)624-5010

PANASONIC SALES COMPANY

DIVISION OF MATSUSHITA ELECTRIC OF PUERTO RICO, INC.

San Gabriel Industrial Park, 65th Infantry, Ave. KM. 9.5 Carolina, Puerto Rico 00630 (809)750-4300

N0194-0

YWV8QA3256AN

Printed in Japan